



554

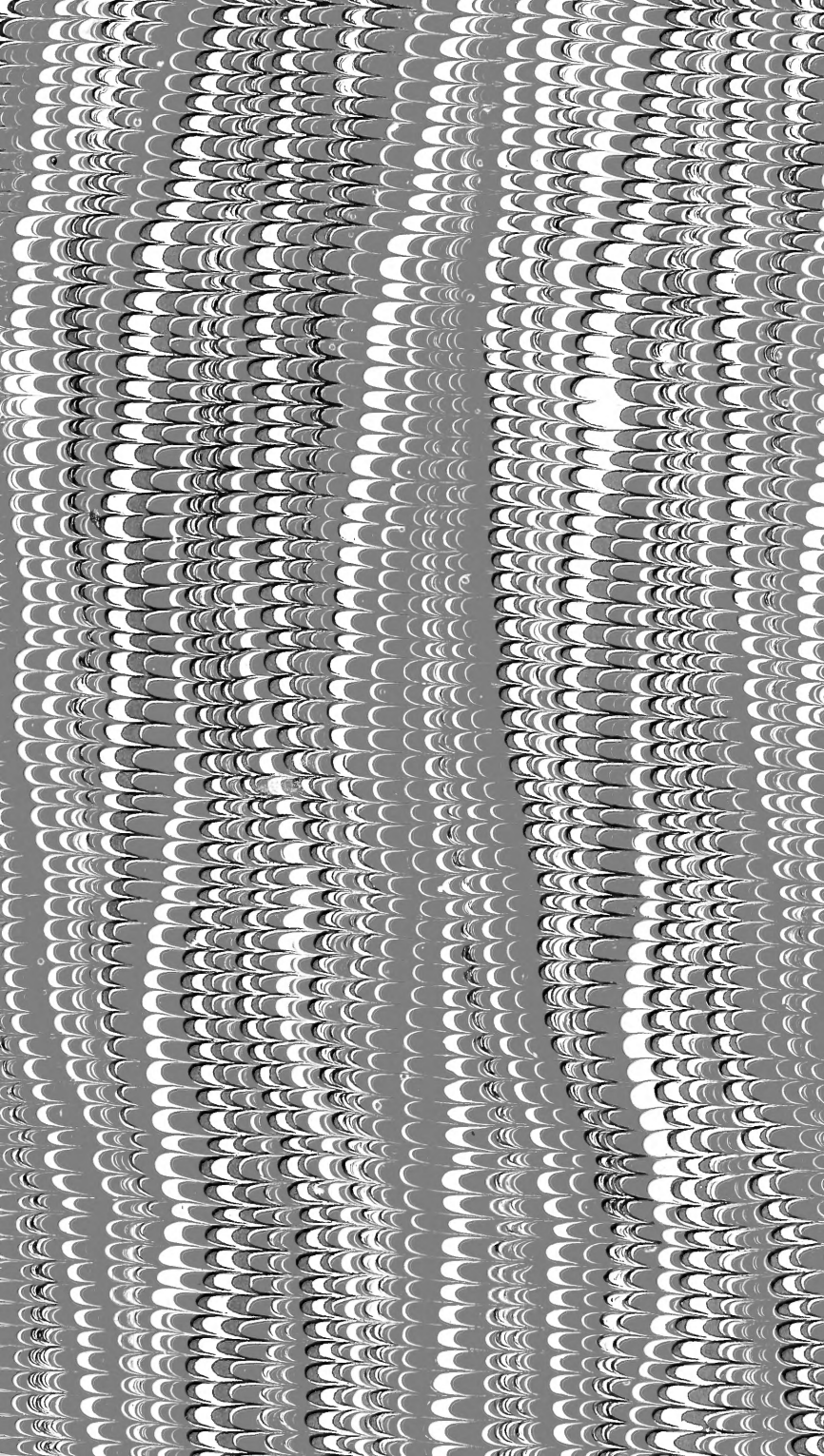
SCIENTIFIC LIBRARY



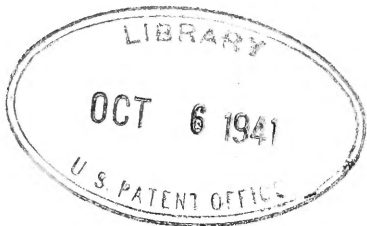
UNITED STATES PATENT OFFICE

GOVERNMENT PRINTING OFFICE

11-8625







LIBRARY

OCT 6 1941

U S PATENT OFFICE









9  
327268  
Pat.  
213-1051

THE

# GARDENER'S MAGAZINE,

AND

REGISTER

OF

RURAL AND DOMESTIC IMPROVEMENT :

COMPRISING

TREATISES ON LANDSCAPE GARDENING,  
ARBORICULTURE, FLORICULTURE, HORTICULTURE,  
AGRICULTURE, RURAL ARCHITECTURE,  
GARDEN STRUCTURES,  
PLANS OF GARDENS AND COUNTRY RESIDENCES,  
SUBURBAN VILLAS, &c.

ALSO

LISTS OF NEW AND RARE PLANTS, FRUITS AND VEGETABLES.

CONDUCTED BY

J. C. LOUDON, F.L.S. H.S. &c.

AUTHOR OF THE ENCYCLOPÆDIAS OF GARDENING, OF AGRICULTURE, &c.

VOL. V:

NEW SERIES.

LONDON :

PRINTED FOR THE CONDUCTOR ;

AND SOLD BY

LONGMAN, BROWN, GREEN, AND LONGMANS,

PATERNOSTER ROW ;

AND A. AND C. BLACK, EDINBURGH.

1839.

GARDNER BROS. & CO. CHICAGO

S B

403

G 22

~~XXXXXXXXXX~~

5B  
4  
G228  
1.5, New ser.  
1839  
SCN#R6

# P R E F A C E.

THE Contents of this Fifteenth Volume of the *Gardener's Magazine* are arranged as under:—

	Page		Page
Communications:—		Miscellaneous Intelligence:—	
Subject	iii	General Notices	vi
Historical and Statistical	iii	Foreign Notices	vi
Historical, Critical, and Descriptive	iii	Domestic Notices	vii
Facts of the Winter of 1837-8	iv	England	vii
Influence of Vegetable Culture	iv	Scotland	viii
Plants and Insects relatively to		Ireland	viii
Gardens	iv	Retrospective Criticism	viii
Garden Structures, Tools, and In-		Queries and Answers	viii
struments	iv	London Horticultural Society and Gar-	
Sources of Artificial Heat	iv	den	viii
Landscape-Gardening and Garden Ar-		West London Gardener's Association	
chitecture	iv	for mutual Instruction	viii
Arbiculture	iv	Royal Caledonian Horticultural Society	viii
Effects of Kyanising Wood	v	Visits to Suburban Gardens	viii
Culture	v	Botanical Expedition to Columbia	viii
Economic Economy	v	Foreign Botanical and Horticultural	
Culture	v	Agency	viii
Culture	v	Covent Garden Market	viii
Subject	v	Biography	viii
Culture	v	Obituary	viii
Culture	v	List of Engravings	viii
Horticulture	v	List of Plants included in the Floricultural	
Agriculture	vi	and Botanical Notices recorded as supple-	
Horticultural and Agricultural Entomo-		mentary to the <i>Second Additional Sup-</i>	
logy	vi	plement to the <i>Hortus Britannicus</i>	viii
Catalogue:—		List of Plants mentioned or treated of in	
General Subject	vi	the present Volume, arranged alphabeti-	viii
Landscape-Gardening and Rural Archi-		cally	viii
ecture	vi	List of Fruits	viii
Arbiculture	vi	List of culinary Vegetables	viii
Floriculture	vi	List of Agricultural Plants	viii
Horticulture	vi	List of Provincial, Horticultural, Botani-	
Agriculture	vi	cal, and Floricultural Societies	viii
Bee Culture	vi	List of Gardens and Country Seats	viii
Miscellaneous	vi	List of Books reviewed or noticed, alpha-	
		betically arranged	viii
		List of Contributors	viii

## ORIGINAL COMMUNICATIONS.

### GENERAL SUBJECT.

#### *Historical and Statistical.*

	Page
A Summary View of the Progress of Gardening, and of Rural Improvement generally, in Britain, during the Year 1839; with some Notices relative to the state of both in Foreign countries. By the Conductor	704
Provincial, Horticultural, Botanical, and Floricultural Societies, &c.	674

#### *Historical, Critical, and Descriptive.*

Design for the Leeds Zoological and Botanical Gardens, approved of by the Provisional Committee	305
Remarks on Mr. Billington's Plan for the Leeds Zoological and Botanical Gardens	306
Design for the Leeds Zoological and Botanical Gardens, presented to the Provisional Committee by Joshua Major	316
Remarks on the Gardens of the Royal Botanic Society of London, Inner Circle, Regent's Park. By the Conductor	322

	Page
Recollections of a Tour chiefly between London and Sheffield, made during the last Three Weeks of May, 1839. By the Conductor	433
Some Account of Gardens, and the State of Gardening in the North and West Ridings of Yorkshire. By J. B. W.	209
Notes on some Suburban Villas between London and Cheshunt, made on July 24. and August 10. 1839, comprising Powis Park, Culland's Grove, Arno's Grove, Minchenden House, Southgate Lodge, South Lodge, Theobald's Park, and Oakhill. By the Conductor	509
Notes on Suburban Gardens. By the Conductor	422
Notices of the Gardens and Nurseries in Lyons and its Neighbourhood. From the <i>Annales d'Agriculture, &amp;c. de Lyon</i> , for 1838	112
Notes taken from the Narrative of a Horticultural Journey in Greece, during the Summer of 1837. By Eugene Achille Baumann, of the Bollwyller Nursery	97

Historical Notice of the Botanic Garden of Padua. Communicated by Signor Giuseppe Manetti, of Monza -	316	On the Use of a new Kind of Wire Netting, for various Purposes in Gardening and Planting, &c. By S. T. -	222
The ancient History of the Rose. By Randle Wilbraham Falconer, Esq., M.D. -	379	Some Account of a Box for the Propagation of Cape Heath. By N. M. T. -	21
Some Inquiry concerning the Quercus and Fagus of the Ancients. By H. L. Long, Esq. -	9	Remarks on Garden Tallies; Kyanisng for Tallies; the Menogramme; Conservatory, Greenhouse, and Stove Tallies for private Collections; Tallies for Alpine Rock Plants, &c.; Tallies for general botanical Garden Purposes in the open Garden; Tallies for naming Trees, &c., against Walls; Tallies for Water-plants, in Ponds or Margins of Lakes in Pleasure-grounds; Labels suited to receive Numbers, not Names, of Plants, and the Mode of Numbering allowed to be most simple and durable. By W. H. Baxter -	542
On inoculating the Rose on the Orange, and similar Practices; and on Mr. Long's Paper on the Quercus and Fagus of the Ancients. In a Letter to Major Webb from his brother, P. B. Webb -	589	- Sources of Artificial Heat.	
On the Olive and Date Plantations in New South Wales. By Dr. Lhotsky -	595	On the Employment of Arnott's Stove for heating Green-houses. By T. Rivers, jun. -	107
Some Remarks on Brazilian Esculents and Fruits. By Dr. Lhotsky -	329	Account of a new Substitute for Tan and Stable Manure, in forming Hot-beds. Communicated by John Grigor -	248
Note on the Jalap Plant of Commerce. By D. Beaton -	328		
Notes, horticultural and agricultural, on the Brazils and New Holland. By Dr. Lhotsky -	249		
<i>Effects of the Winter of 1837-8.</i>			
An Account of the Trees and Shrubs which were killed or otherwise injured, with a few of those which were uninjured, by the Severity of the Winter of 1837-8, in the Botanic Garden, &c., Oxford. By W. H. Baxter -	57		
On the Influence of the Winter of 1837-8 on certain half-hardy Shrubs in the Glazewood Nursery. By Samuel Curtis, F.H.S. -	233		
Notice of the Effects of the Winter of 1837-8 on certain Trees, Shrubs, and Plants, hardy and half-hardy, cultivated in the Handsworth Nursery, near Birmingham. By Alexander Pope -	231		
The Winter of 1837-8 at Munich, and its Effect on the Plants there. By M. L. C. Seitz, Royal Court and Botanic Gardener at Munich, from the <i>Garten Zeitung</i> for August 1838 -	61		
<i>Science of Vegetable Culture.</i>			
Remarks on Mirbel's <i>Nouvelles Notes sur le Cambium</i> , extracted from a Work on the Root of the Date Palm. By James Main, A.L.S., &c. -	592		
On the Means of ascertaining the Degree of Humidity most suitable for the Atmosphere of Hot-houses. By George Wailes -	506		
On the atmospheric Moisture of Hot-houses; on the Management of Orchidaceous Plants; and on gathering and packing Orchids for long Voyages. By D. Beaton -	552		
On acclimatising Plants in British Gardens. By N. M. T. -	219		
Description of a Plant Case, or Portable Conservatory, for growing Plants without fresh Supplies of Water and Air, according to the Method of N. B. Ward, Esq.; with Physiological Remarks. By Daniel Ellis, F.R.S.E. -	481		
<i>Birds and Insects relatively to Gardens.</i>			
Remarks on the Usefulness of Birds in Agriculture and Gardening. By G. Ord -	327		
A Series of Articles on the Insects most injurious to Cultivators. By J. O. Westwood, F.L.S., Secretary to the Entomological Society of London. No. 15. Celery and Chrysanthemum Leaf-Miners -	103		
<i>Garden Structures, Tools, and Instruments.</i>			
On rustic Doors swung on Pivots, with rustic Porches. By Alexander Forsyth -	539		
Design for a Trellis for Fruit Trees erected in the Gardens of Sir James Carnegie, Bart., Kinraid Castle, Forfarshire. By Robert Gardiner, Gardener there -	599		
Notice of a light Folding Ladder, adapted for various Purposes in Gardening and domestic Economy. Drawn up from Notes and a Model communicated by D. Beaton, Gardener to Thomas Harris, Esq., F.H.S., &c., of Kingsbury -	56		
		LANDSCAPE-GARDENING AND GARDEN ARCHITECTURE.	
		Descriptive Notices of select Suburban Residences, with Remarks on each; intended to illustrate the Principles and Practice of Landscape-Gardening. By the Conductor.	
		No. 10. Mount Grove, Hampstead -	1
		No. 11. The Rock-Garden of Thomas Millie, Esq., in St. Clairtown, near Kirkaldy, Fifeshire -	49
		No. 12. Redleaf, the Seat of William Wells, Esq., F.H.S. -	353
		No. 13. Garden Cottage, Cheshunt, the Country Residence of William Harrison, Esq., F.L.S., &c. -	633
		Remarks on the Charges made by Landscape-Gardeners and Garden-Architects. By the Conductor -	213
		ARBORICULTURE.	
		Arboricultural Notices, collected from various Sources, intended as supplementary to, or corrective of, the Information contained in the <i>Arboretum et Fruticetum Britannicum</i> -	118.
		The Arboriculture of the Voyage of Captains King and Fitzroy to the Straits of Magellan and Terra del Fuego. By Capt. S.E. Cook, R.N. -	692
		An Account of the preparatory Operations made in the Birmingham Botanic Garden previously to planting the Arboretum there; with the Dimensions which some of the Trees have attained in Seven Years. By D. Cameron, Curator there -	537
		Pines found in the Taurian Caucasus. By C. Stevens -	224
		Description of the <i>Picea Pinsäpo</i> , a new Species, discovered in Spain by M. E. Boissier, in 1837. By Charles Lawson, Esq. -	109
		List of Coniferous Trees in the Pinetum of Baron de Serret, at Beernem, near Bruges. By Baron de Serret -	325
		Notice of a new hybrid Mahonia, or Evergreen Berberry. By T. Rivers, jun., F.H.S., &c. -	235
		A Proposal to name Collections of Trees and Shrubs in Public Gardens and Nurseries, under certain Circumstances, and on certain Conditions. By the Conductor -	517
		The recent Plantations in Kensington Gardens and Hyde Park. By the Conductor, -	131
		An Account of a new Weeping Larch. By W. Godsall -	547
		On the Cypress of Mistra. By the Earl of Aberdeen -	697
		On different Modes of securing newly planted Trees against high Winds, with a new Plan for that Purpose. By Samuel Taylor -	545

*Effects of Kyanising Wood.*

Results of certain Experiments in Kyanising different Species of Wood for being used as Garden Tallies; with Remarks on the Effect of Kyanising Hop-poles. By W. Masters, F.H.S., &c. - 320

On the injurious Effects of Kyan's Anti-Dry-Rot Solution, as regards the Destruction of vegetable Life in the Gardens at Thoresby, Nottinghamshire. Communicated by the Right Hon. the Earl Manvers' - 517

Notice respecting the Effects of Kyanised Wood on growing Plants, in the Hot-houses, Pits, and Frames of the Hackney Nursery. By the Conductor - 588

On the Kyanising Process, and on other Modes of seasoning Timber. By James Monro, Forester to the Marquess of Northampton - 585

FLORICULTURE.

Botanical, Floricultural, and Arboricultural Notices on the Kinds of Plants newly introduced into British Gardens and Plantations, or which have been originated in them; together with additional Information respecting Plants (whether old or new) already in Cultivation; the whole intended to serve as a perpetual Supplement to the *Encyclopædia of Plants*, the *Hortus Britannicus*, the *Hortus Lignosus*, and the *Arboretum et Fruticetum Britannicum*, 68. 242. 394. 463. 520. 557. 596

Notice of a remarkable Specimen of *Cereus speciosissimus*, growing in the Stove of Thomas Holman, Esq., at Folkstone, in Kent. By N. M. T. - 22

On the Culture of *Cactæe*. By Dr. Pfeiffer of Cassel - 83

On the Extension and Use of the *Cacti*. By Professor Zuccarini, Subcurator of the Royal Botanic Garden at Munich - 153

Observations on the geographical Extension of the *Cacti* in Brazil. By Professor Von Martius - 389

On *Cereus senilis*, the Old-Man Cactus. By D. Beaton - 549

On grafting *Ipomœeae*, and more particularly *Ipomœa Horsfalliæ*. By D. Beaton - 161

Notice of *Galphimia glauca*, and of a new *Wistaria*. By D. Beaton - 400

A Selection of Heaths, made with the View of having several Species in Flower during every Month in the Year, with Remarks

on their Culture, &c. By W. A. Masters, late Subcurator of the Canterbury Museum - 402

HORTICULTURE.

A Pine-apple Conservatory. By Alexander Forsyth - 404

Remarks on the Cultivation of the Vine. By James Hutchinson - 405

Historical Notices respecting the Training and Pruning of the Peach Tree in France. Extracted from a Report made to the Horticultural Society of Paris in July, 1836, and published in the *Annales d'Horticulture*, vol. xix. - 409

On the Peach. By Alexander Forsyth - 600

On shading Melon and Cucumber Plants. By John Wighton - 412

A Selection of Standard Pears and Apples suitable for small Gardens in the Climates of London, Edinburgh, and Dublin. By Robert Thompson, of the Fruit and Kitchen Garden Departments in the London Horticultural Society's Garden - 138

Some Remarks on the Ripening of Pears, in the Years 1837, 1838, and 1839. By T. Rivers, jun. - 141

On the Culture of the Mushroom. By Alexander Forsyth - 333

On the Culture of the Carrot. By Alexander Forsyth - 604

DOMESTIC ECONOMY.

On preserving Plums. By M. W. C. Bosse, Nurseryman, Quedlinburg - 602

BEE CULTURE.

On the Calling of the Queen Bees before Swarming. By John Wighton, Gardener at Cossey Hall - 25

On the Queen Bee that leaves the Hive with the first Swarm. By J. Wighton - 605

AGRICULTURE.

On the Cultivation of *Madia sativa*, as an Oil Plant. By W. Hertz, Nurseryman and Seedsman, Stuttgart - 142

The Result of certain Experiments in cultivating different Varieties of Wheat. By John Rivers - 23

Notice of an Experiment made with Four Seeds of Wheat, sown in June, 1836. By A. Gorrie - 24

REVIEWS.

GENERAL SUBJECT.

Gardening and Agriculture of the ancient Egyptians. By J. G. Wilkinson, F.R.S., &c. - 611

The Botanical Periodicals - 90

Second Annual Report and Proceedings of the Edinburgh Botanical Society - 257

Fifth Annual Report of the Jersey Agricultural and Horticultural Society for 1838 - 344

Annales des Sciences Physiques et Naturelles d'Agriculture et d'Industrie - 168

Elenchus Plantarum novarum minusque cognitatarum quas in Itinere Hispanico legit Edmundus Boissier - 337

Le Bon Jardinier, Almanac pour l'Année 1839, accompagné d'une Revue Horticole. By MM. Poiteau et Vilmorin - 162

Royle's Illustrations of the Botany and other Branches of the Natural History of the Himalayan Mountains, and of the Flora of Cashmere, &c. - 253

Harvey's Genera of South African Plants, arranged according to the Natural System - 340

The Green-house, Hothouse, and Stove; including select Lists of the most beautiful Species of Exotic Flowering Plants, and Directions for their Cultivation. By Charles M'Intosh, F.H.S. - 26

Catalogue of Plants cultivated in the Birmingham Botanic Garden - 413

ARBORICULTURE.

Pinetum Woburnense; or a Catalogue of Coniferous Plants in the Collection of the Duke of Bedford at Woburn Abbey; systematically arranged - 263

FLORICULTURE.

Mrs. Loudon's Ladies' Flower-Garden of ornamental Annuals - 88

Abbildung und Beschreibung, &c.; that is, Figures of *Cacti* in Flower, painted and lithographed after Nature, with Descriptions, &c. By Dr. Louis Pfeiffer, and M. Otto, Director of the Royal Botanic Garden at Berlin - 522

Lindley's Sertum Orchidaceum; a Wreath of the most beautiful Orchidaceous Flowers - 336

Francis's Little English Flora - 87

HORTICULTURE.

Rogers's Vegetable Cultivator - 345

Goodwood, its House, Park, and Grounds, with a Catalogue raisonné of the Pictures in the Gallery of His Grace the Duke of

Richmond, K. G. By William Hayley Mason, Librarian of Goodwood - - -	523
The Young Farmer's Manual. B. J. Main, A.L.S. - - - - -	523

## AGRICULTURE.

The Journal of the English Agricultural Society - - - - -	345
---	-----

## HORTICULTURAL &amp; AGRICULTURAL ENTOMOLOGY.

Die Vier Hauptfeinde der Obstgärten, &c. The Four principal Enemies of the Orchard, with the most effective Means for their Destruction. By Vincent Kollar, Keeper of the Imperial Cabinet of Natural History - - - - -	171
Westwood's Introduction to the modern Classification of Insects - - - - -	32
Westwood's Entomologist's Text-Book - - - - -	30

## CATALOGUE.

Catalogue of Works on Gardening, Agriculture, Botany, Rural Architecture, &c., lately published; with some Account of those considered the more interesting:—

## General Subject.

Decandolle's. Vegetable Organography. Translated by B. Kingdon - 174. 468.	702
Cooper's Catalogue of the British Natural Orders and Genera - - - - -	174
Proceedings of the Linnean Society of London - - - - -	176
Proceedings of the Royal Asiatic Society in relation to Agriculture and Gardening - - - - -	177
Audibert's Catalogue des Arbres, Arbustes, et Plantes, &c., cultivés à Tonelle - - - - -	180
Legrandais's Catalogue des Plantes cultivées à Avranches - - - - -	180
Séringe de l'Hybridité dans les Plantes et les Animaux, &c. - - - - -	181
Séringe's Essai des Formules Botaniques - - - - -	182
Plantes des Environs de Toulon - - - - -	183
Le Courier Agricole et Horticole, &c. - - - - -	184
Lindley's School Botany - - - - -	275
Marcet's Vegetable Physiology - - - - -	276
Dillwyn's Review of the Hortus Malabaricus Mawe and Abercrombie's Every Man his own Gardener - - - - -	276
Endlicher's Grundzüge einer neuen Theorie der Pflanzung eugung - - - - -	287
Second Additional Supplement to Loudon's Hortus Britannicus - - - - -	416
Lindley's Lady's Botany abridged - - - - -	561
Dillwyn on the Effects of the Winter of 1837-8 on some Shrubberies and Gardens in Glamorganshire - - - - -	561
Sweet's Botanical Cultivator - - - - -	701
Don's Edition of Sweet's Hortus Britannicus 701	

## Landscape-Gardening and Rural Architecture.

Loudon's Edition of Repton's Landscape-Gardening and Landscape-Architecture - 466	
Châteauneuf's Architectura Domestica - 703	

## Arboriculture.

Millet's Notice sur la Culture des Oseraies dans l'Aisne - - - - -	181
Main's Forest Pruner and Pruner's Assistant - - - - -	467

## Floriculture.

Willmot's Amateur-Florist's Assistant - 174	
The Bouquet, or Lady's Flower-Garden - 175	
Loddiges's Catalogue of the Orchidea in their Collection - - - - -	177
Pile's Floriculturist - - - - -	276
Berlise's Iconographie du Genre Camellia - 467	

## Horticulture.

Smith's Treatise on the Growth of Cucumbers and Melons, conjointly with that of Asparagus, Mushrooms, Rhubarb, &c. - 175	
Duncan's Practical Treatise on the Culture of the Melon - - - - -	175
Glendinning's Practical Hints on the Culture of the Pine Apple - - - - -	277
Niven's Treatise on an improved and cheap Method of cultivating Asparagus - - - 279	

## Agriculture.

Recueil par la Société d'Agriculture d'Avranches - - - - -	182
Sinclair's Hortus Gramineus Woburnensis - 702	

## Bee Culture.

Payne's Apiarian Guide - - - - -	178
Taylor's Bee-keeper's Manual - - - - -	286

## Miscellaneous.

Ure's Dictionary of Arts, Manufactures, and Mines - - - - -	34. 179. 282
Claxton's Hints to Mechanics on Self-Education and Mutual Instruction - - - 179	
The Year-Book of Facts. By the Editor of the Arcana of Science - - - - -	179
The Mirror of Literature, Amusement, and Instruction - - - - -	180. 471
The Transactions of the Society of Arts for 1837-8 - - - - -	281
Moseley's Treatise on Mechanics - - - - -	282
The British Almanack for the Diffusion of Knowledge for 1839 - - - - -	282
Companion to the Almanack for 1839 - - 282	
Report of the Society for obtaining free Admission to Societies and public Edifices containing Works of Art - - - - -	417
Smith's Suggestions on National Education - 417	
Waterton's Essays on Natural History - 417. 468	
Ingpen's Instructions for collecting, rearing, and preserving British Insects - - - - -	468
Howard's Science of Drawing - - - - -	469
Howard's Sketcher's Manual - - - - -	470
Howard's Colour as a Means of Art - - - 470	
Signmond's Treatise on Tea; its Effects medicinal and moral, &c. - - - - -	471
Booth's Stranger's Intellectual Guide to London for 1839-40 - - - - -	471. 562
The Civil Engineer and Architect's Journal 703	
The Engineer and Surveyor's Magazine - 703	
Timb's Literary World - - - - -	703
The Guide to Service.—The Maid of All-Work, House Maid, Lady's Maid, Nursery Maid - - - - -	703
Fennel's Child's Book of Zoology - - - - -	704
Loudon's Edition of Repton's Landscape-Gardening, &c. - - - - -	418

## LITERARY NOTICES.

Waterton's Essays on Natural History - 419	
Wight's Illustrations of Indian Botany - 288	
Wight's Icones Plantarum Indiæ Orientalis 288	
Kollar's Insects Injurious to Gardeners, Foresters, &c. - - - - -	288

## MISCELLANEOUS INTELLIGENCE.

## GENERAL NOTICES.

Self-Improvement, M. C., 36; Registering Thermometers, R. T., 36; Growing Plants under Glass Cases without changing the Air or Water, W. S., 36; Insufficiency of Parchment Labels, W. C., 37; Application of Coal Tar to Fruit Trees, W. G., 37; Epidibium hirsutum, W. T., 37; Verbena teucrioides, 37; A Stone-ware Churn, 144; Kyanising Wood, 184; Employment of Mineral Tar, or Pyroligneous

Liquor, for the Protection of Walls of Masonry or of Mud, 185; Preserving Specimens of Plants, or of Organic Substances generally, 185; Phenomena observed in the Freezing of Potatoes, 185; Ultimate Principle of Nutrient to Animals in Vegetable Food, and to Vegetables in Manure, 186; On the Part which Soil acts in the Process of Vegetation, 186; To preserve Hedge-bills, Scythes, Sickles, and other Steel Instruments, from rusting, 186; Grafting-Wax

and Grafting-Clay, 186; Absorption of Azote by Plants during Vegetation, 186; Liquid Manure, S. T., 186; Pots for Orchidaceous Plants, J. D., 187; *Torrèya taxifolia*, 187; *Prepùsa connàta* Hook., D. Beaton, 187; The Cow Tree, or Palo de Vaca, D. Beaton, 187; *Picea Pm-sàpo* Boissier, D. Beaton, 187; *Pæonia* [officialis] Makóya, 188; Asphaltic Pavement, 188; Principle on which general Education ought to be founded, 189; Music as a Relaxation, 189; Light, 189; An Earwig Trap for Dahlias, W. C., 189; Acclimatisation of Plants, 289; The Effect of severe Frost on Plants, J. W. L., 290; Importance of Selection in setting apart Plants for producing Seed, 290; The Necessity of Selection of Plants, 291; Cemeteries, 291; An economical Pit for forcing Dahlias, &c., 291; Sporting of Plants, 292; Van Mons's Theory for the Amelioration of Fruits, 292; Budding with a terminal Eye, 292; Grafting Pinks and Carnations, 293; Grafting the Sweet Chestnut on the Oak, 293; Striking Camellias from single Eyes, 293; An improved Method of training Raspberries, 293; Uses of the common Hollyhock, 293; The Maggot on Onion Crops, Robert M'Nab, 294; Destroying the Caterpillar on Gooseberries, Thomas Simpson, 294; Preservation of Fruit, 295; A Benefit Society for Gardeners, E. S., 295; Prevention of Hail Storms, 295; *Milium effusum* and *Elymus geniculatus*, A. Gorrie, 471; *Melilotus* as a Forage Plant, ib., 472; *Kühnia eupatorioides*, D. B., 472; Disinfecting Nightsoil, F. F., 472; Insuring the Prolificacy of the Houtbois Strawberry, J. M., 472; The Milford Pea, John Scott, 472; *Sóllya heterophylla* var. *linearis*, 472; Daguerre's Photography, J. R., 473; Neglect of Arboriculture by the British Government, 525; Marder's Grafting Composition, 525; An Earthen Water-Holder, H. Taylor, 525; The Dahlia-Holder, B., 526; The essential Point in the Culture of Fruit Trees, J. B., 526; *Nelumbium speciosum* var. *rubrum*, N. W. G., 526; Williams's Boiler for heating Hot-houses, 526; The Irritability of the Stigma of the Genus *Mimulus*, N. W. G., 527; Altering and improving an old Mansion, 527; Paving with Wood, 527; The Character of Soils in Relation to Vegetable Culture, 562; Subsoil-Ploughing and the Frequent-Drain System, 563; Black the very worst Colour for painting Woodwork in the open Air, 563; The Improvement of Harbours and of Drainage by Rivers, 563; Warming and Ventilating, 564; The Method of heating Houses practised in Paris, 565; Prepared Fuel for Hot-house Furnaces, &c., 565; Preservation of Kitchen-Garden Vegetables through the Winter, 566; Choice of Seed Corn, 566; Electricity, 566; The Expression of Grandeur, 567; Labour not hostile to mental Improvement, 567; Temperance Societies, 567; Unity and Variety in Objects essential to Beauty, 567; Patent flattened Crown Glass, 614; Setting the Blossoms of Stillwell's Sweetwater Grape, W. Brown, 614; Increasing the Number of Flowers produced by *Primula sinensis*, W. Brown, 614; Filling an Ice-House, W. Brown, 615; Forming artificial Climates, 615; Irregularity of the Organs of Vegetables, 615; Tanning Principle, 616; Husking the Palm of Chile, 616; Culture of Cabbage, John Tims, 616; Fastening Trees to Walls, a Constant Reader, 616; Paper from the inner Bark of *Morus papyrifera*, H., 617; Cloth from the Nettle and the Bramble, 617; Marc of Grapes, 617; Bone Dust, 617; Regenerating old Pasture, C. G. Stuart Menteith, 617; A Hint as to Trenching, and the Use of Coal Ashes, 618; Hardening Gravel Walks, 618; Important Influence of the Air we breathe on the general System, 619; Pecuniary Charity, 619; An Experimental Hive, R. T., 620; Domestic Economy and Cookery, 620.

## FOREIGN NOTICES.

France.—Rendering Vegetable Substances incombustible, 190; Versailles, 190; The Go-

vernment of Louis-Philippe, 191; The Spirit of moral Improvement, 191; Paris has nothing to match Hyde Park and Regent's Park, 191; A School of Agriculture at Rouen, 191; A normal School of Agriculture, 191; La Greffe herbace, 295; The Grapes of Fontainebleau and Thomery, 295; A new Tile for Roofs, J. R., 473; The Billandeau Cabbage, Chou de M. Billandeau, 568; Do Varieties reproduce themselves from Seed? 568; Varieties of the Vine, 569.

Belgium.—? *Dámara* sp., Fred. E. Wagner, 296; Ghent Floral Exhibition, R. L., 296.

Holland.—Gardens of Balconies in Rotterdam, 296.

Italy.—The Garden of Desio, G. Manetti, 191; Cypress of Somma, G. Manetti, 192; Laurel of Isola Bella, G. Manetti, 192; Truffe, G. Manetti, 192; *Wistaria sinensis*, G. Manetti, 193; Culture of the Truffe, G. Manetti, 419; Culture of the Mushroom, ib., 419; The Garden of Baron Zanoli, and of M. Ulrich, ib., 420.

Portugal.—The Vine, 297; Vineyards of Portugal, and Villas in the Neighbourhood of Lisbon, J. B. Williams, R. N., 621.

Germany.—*Prötea Múndii* Klotzsch, 569.

Sweden.—The old Botanic Garden at Upsal, 297; Death of the Daughter of Linnaeus, 297.

Finland.—The Boundaries of Bread Corn in Finland, 194.

Russia.—The Flora of Novaia Zembla, 621.

Iceland.—Horticulture about the End of the Eighteenth Century, 298.

India.—Culture of the Tea in India, 194; The Botanical Gardens of Calcutta, 298. 569. 622.

North America.—Botanic Nurseries, Newburgh, New York, A. J. Downing, 38. Philadelphia; Notice of *Kühnia eupatorioides*, *Epigæa repens*, &c., X. Y., 144; An American Sash-fastener, James Frewin, 194; Spencer Wood, near Quebec, Henry Atkinson, 195; Catalogue of Dahlias, George Thorburn, 528.

Australia.—The Sydney Floral and Horticultural Society, 473.

## DOMESTIC NOTICES.

England.—New Ligneous Plants, D. C., 39; *A'lnus cordata*, W. Christy, jun., 39; *Aristolochia trilobata*, W. Christy, jun., 39; Hurricane of Jan. 7., I. H. S., 91; Rose-Stock Impositors, 92; Glazenwood Nursery, T. B., 92; Specimens of Wheat, Samuel Taylor, 92; New Range of Glass erecting in the Horticultural Society's Garden, 145; *Gárrya laurifolia*, 147; Importation of *Cacti*, *Orchideæ*, &c., 147; The Royale Hátive Plum, R. T., 148; Van Mons Léon le Clerc Pear, R. T., 148; Effects of the Hurricane of Jan. 7., 195; *Músa Cavendishii*, 196; Gigantic *Cactus*, 196; Progress of Education, 196; Gardeners' Benevolent Association, 196; Botanic Gardens, Bury St. Edmunds, 299; The Highgate Horticultural Society, B., 299; Hot-water Apparatus at Capheaton, John E. Swinburne, 299; *Hotiza mexicana*, S. T., 300; *Paxtonia røsea Lindl.*, 300; *Melilotus*? *arbdrea Castagne*, 300; *Cánnabis sativa* var. *gigantea*, 301; *Linum usitatissimum* var. *giganteum*, 301; New Herbage Plants, W. P. T., 301; *Dipylaeus pumiceus* and *Petræa volubilis*, D. Beaton, 347; Kew Gardens, 347; The Kent Zoological and Botanical Gardens, 421; Importation of *Cacti*, D. Beaton, 421; *Laburnum* blossoming twice in the Year, W. S. B., 422; Danish Gardeners in England, 422; The Horticultural Society's Exhibition in the Chiswick Garden, 476; A Society for promoting the Improvement of the Working Classes, 476; Trees blown down at Knowsley Park, Wm. Somerville, 477; Mr. Buist of Philadelphia, 529; The English Agricultural Society, 529; Cottages and Cottage Gardens of Llanhennock, 529; *Rhododéndron arboreum*, 529; *Pinus Llaveana*, 530; *Doryánthes excelsa*, 530; *Crocus lacteus* var. *lutescens Herb.*, H. Turner, 530; Hybrids between *Fúchsia fulgens* and *F. grandiflora*, T. Colley, 530; A Collection of Seeds from Thibet and Cashmere, 531; M. Poiteau and M. Tripet-Leblanc, 570; City

- Gardens, 570; Large Trees at Brockley Hall, Somersetshire, J. H. S. P., 570; Large Trees at Tredegar, Monmouthshire, Ellen Anne Leyson, 571; Trees blown down at Capheaton, Northumberland, J. E. Swinburne, 571; *Magnolia grandiflora* var. *exoniensis*, 571; *Palurus virgatus*, 572; *Cœlebogyne Aquifolium*, 572; The gigantic Clover, H. Bawell, 572; A National Arboretum, 624; A Subscription Botanic Garden at Reading, 624; Royal Botanic Society, 625; Count Harrach, 625; American Nurserymen in England, 625; Mr. Moore, Curator of the Glasnevin Botanic Garden, 625; Weeping Larch at Denham Hall, Suffolk, T. Rivers, 626; Plants lately raised from Seeds in the Birmingham Botanic Garden, D. C., 626; Refuse Apples as Manure, M. Saul, 626.
- Scotland.**—Dinner to Mr. James M'Donald, R. S. M., 40; Effects of the Hurricane of Jan. 7., 196; The Highland Society of Scotland, 197. 531. 626; Progress of Cottage-Gardening in Fifeshire, 197; An Ornamental Cemetery, 198; *Rhododendron arboreum*, 198; Agricultural Implements sent to England, 301; *Doryanthes excelsa*, 422; Douglas's Monument, 422; Aveyry's Rotary Steam Engine adapted to a Threshing-Machine, 477; Mallet, with a Hoe attached on the one Side, and a Pick on the other, 627; Wooden Pump for Liquid Manure, 627; Plants of the Norway Maple, and of the true Highland Pine, 627; Country Seats in the Neighbourhood of Inverness:—Cantray, 628; Holm, 628; Kilravock, 628; Cawdor Castle, 628; Castle Stewart, a Seat of the Earl of Moray, near Inverness, 628.
- Ireland.**—Phyllocladus, and other Australian Plants, at Belfast, Daniel Ferguson, 41; Effects of the Hurricane of January 7., J. T. M., 198; Gardening in the North-West of Ulster, M., 629.
- Retrospective Criticism.**—Rhubarb Jam, Alexander Campbell, 42; Encyclopædia of Cottage, Farm, and Villa Architecture and Furniture, 93; Raising Cacti from Seeds taken from dead Specimens, A young Subscriber, 149; Calling of the Queen Bees before Swarming, B., 149; Calling of the Queen Bees before Swarming, Wm. Dunbar, 150; List of Fruits in the Suburban Horticulturist, N. H. Graves, 151; *Pinus Pin-sapo* Bois, S. E. Cook, 201; The Horticultural Society, S., 302; The Analogy between Plants and Animals (Errata), J. M., 302; Erratum, 302; *Loasa lateritia*, A Young Subscriber, 431; *Ceanothus collinus*, 431; Erratum, 477; The Catalogue of the Birmingham Botanic Garden, Fred. Westcott, 477; Native Countries and native Habitats of Plants, A. M., 478; The high Keeping of the Sheffield Botanic Garden, R. Marnock, 572; Cause of the Barrenness of the Hautbois Strawberry, Cotswold, 573; *Morus Arb. Brit.*, J. M., 573; *Morus rubra Arb. Brit.*, J. M., 573; *Ulmus fulva Arb. Brit.*, J. M., 574; *Juglans nigra Arb. Brit.*, J. M., 574; The black Italian Poplar, L. C., 629; Insuring the Prolificacy of the Hautbois Strawberry, R. T., 629; Corrections for the Hortus Britannicus, Second Additional Supplement, Baron Jacquin, 630.
- Queries and Answers.**—Names of the different Species of *Corræa*, Amateur, 42; Dr. Arnott's Stove as applied to Plant-houses, W. H. Baxter, 94; Different Species and Varieties of *Corræas*, D. Beaton, 94; Manchester gigantic White Celery, and the large new Purple Russian Celery, Henry C. Ogle, 96; A large Grape raised by Van Mons, J. B. W., 152; A drooping Larch, X., 152; Cut Flowers sent from Paris to London, 202; Fitzwalters, T. S. W., 303; *Kölreutéria paniculata* and *Liriodendron Tulipifera*, Clericus, 303; *Grevillea rosmarinifolia*, J. A. B., 303; The Leek Gros-Court, 303; Professor Henslow's Queries on Hybridising, D. B., 432; *Hedýchium* sp., A Devonian, 331; Breeding Hybrids by reciprocal Fecundation, J. C. Kent, 531; *Ribes sanguineum* killed from an unknown Cause, M. D. B., 630.
- The London Horticultural Society and Garden*, 42. 202. 348. 480. 531. 574. 639.
- The West London Gardener's Association for Mutual Instruction*, 199.
- Royal Caledonian Horticultural Society*, 198. 430.
- Visits to Suburban Gardens.*—Stafford House Flower-Hall, 422; Whitton Park, 424; Teddington Grove, 424; Norbiton Hall, 426; Wimbleton House, 429; The Cottage of H. B. Ker, Esq., in Park Road, Regent's Park, 429.
- Botanical Expedition to Columbia, and melancholy loss of Messrs. Wallace and Banks*, 479.
- Foreign Botanical and Horticultural Agency, by William Pamplin, jun.*, 303.
- Covent Garden Market*, 47. 207.
- Biographical Notice of William Watt, James Dall*, 584.
- Obituary.**—Mr. George Penny, A.L.S., Henry Allen, 96; Mr. John Hunneman, 208; M. Tripet, 304; Dr. F. Falderman, 304; William Christy, Esq., jun., F.L.S., 536; John Robertson, Esq., F.H.S., 584.

## LIST OF ENGRAVINGS.

No.	DIAGRAMS.	Page	No.	Page	
20.	An Idea for Doors and Windows in hot Climates	93	143—145.	Ancient Egyptian Gardeners drawing and carrying Water	608
33, 34.	Peculiarities of Growth in Bulbs	169	<b>INSTRUMENTS, IMPLEMENTS, UTENSILS, AND MACHINES.</b>		
37—39.	Monstrosities in <i>Dictamnus Fraxinella</i> , and in the common Potato	203, 204	6—8.	Boxes for the propagation of Cape Heaths	21
81.	Details of the Latch of One of the Entrance-Gates at Redleaf	364	10, 11.	Wooden Tallies for Nurserymen, as a Substitute for Parchment Labels	37
94.	Section to show how the steep Banks of deep Cuttings and Railways may be rendered available for agricultural Purposes	437	12.	Baskets of different Forms for protecting Plants	44
103—107.	Various Details of a Door Stay-Bar for Cottages or other Buildings, or for Gates	439—441	16—19.	A folding Ladder for pruning standard Trees in the open Air and in Hot-houses	56
109.	Details of Gates formed of Cast-Iron and Wood	443	24.	A Stoneware Hand-Churn	144
110.	Mode of trussing a Joist or Girder	443	29.	A Sucker for watering Plants in Pots which are at a considerable Distance from the Operator	166
116—118.	Details of Cast-Iron Gutters for Roofs	445, 446	30.	The Extirpateur-Courval, for rooting up Docks and Thistles	166
120.	Section of a Sash-Bar with Grooves for the Glass	453	31.	The Volante, a small Hand-Scythe	166
121.	Lines showing the Arrangement of Trees and Shrubs in the Sheffield Botanic Garden	454	32.	A Wheel Verge-Cutter	168
132.	Plan for preventing Sashes from rattling with the Wind	527	35.	An Earwig Trap for Dahlias	180
			36.	An American Sash-Fastener, for [the Windows of Green-Houses or Cottages	195
			40—42.	A Flower-Pot, with pierced Rims	





## LIST OF PLANTS

INCLUDED IN THE FLORICULTURAL AND BOTANICAL NOTICES RECORDED SINCE THE PREPARATION OF THE "SECOND ADDITIONAL SUPPLEMENT TO THE HORTUS BRITANNICUS" CONTAINED IN THE PRESENT VOLUME.

Those species and varieties marked with a \* are figured and recorded for the first time; and those with a † are recorded for the first time, but not figured; the remaining names are introduced on account of some additional information respecting them.

<i>Ranunculaceæ.</i>		SCOTTIA	dentata	■ □	New Holland	-	559
PICCONIA	Brównii	* △	North America	-	-	394	
<i>Berberaceæ.</i>		ZI'CHYA	coccinea	■ □	New Holland	-	395
<i>Papaveraceæ.</i>			*tricolor	■ □	Swan River	-	558
EPIME'DIUM	*Musschiànum	* △	Mexico	-	-	520	
<i>Cruciferae.</i>		<i>Rosaceæ.</i>					
GLAUCIUM	rùbrum	○	Greece	-	-	46†	
PAPAYER	amœnum	○	North of India	-	-	46†	
<i>Cappari'deæ, or Sapind'eæ.</i>		AMYGDALUS	incana	■	Caucasus	-	597
ERY'SIMUM	Perovskianum	○	Palestine	-	-	243	
<i>Caryophyll'eæ.</i>		POTENTILLA	*hamatochrus	£ □	Mexico	-	597
DIPLOPE'LTIUS	Hugèlii	■ □	Swan River	-	-	394	
<i>Malv'eæ.</i>		SPIRÆA	*cuneifolia	■	Nepal	-	521
DIA'NTHUS	ferrugineus	£ ○	Italy	-	-	243	
<i>Balsamin'eæ.</i>			†flaxiflora	-	-	521	
ABU'TILON	†striatum	■ □	-	-	-	395	
MA'LVIA	†lucida	○	Nepal	-	-	596	
	mauritiàna	○	South Europe	-	-	46†	
<i>Oxalideæ.</i>			vacciniifolia	■	Nepal	-	521
BALSAMI'NA	*Mastersiana	○	Khosea	-	-	395	
<i>Rut'eæ.</i>		<i>Philadelph'eæ.</i>					
O'XALIS	Barrelièri	■ □	Caraccas	-	-	558	
	Darvelliana	* △	-	-	-	243	
<i>Leguminos'eæ.</i>		DEUTZIA	corymbosa	■	Himalayas	-	395
CORRE'A	*ferruginea	■ □	Australia	-	-	395	
<i>Compos'iteæ.</i>		PHILADE'LPHUS	Gordonianus	■	California	-	395
ACA'CIA	†cuneata		Swan River	-	-	46†	
	cyanophylla	? ■	Swan River	-	-	395	
	*Riceana	■ □	Van Diemen's Land	-	-	559	
BAURYNIA	corymbosa	■ □	East Indies	-	-	558	
	forficata	■ □	Brazil	-	-	521	
CHORO'ZEMA	svàrium	■ □	Swan River	-	-	558 †395	
<i>Cact'eæ.</i>		LOA'SA	lateritia	■ □	Tucum	-	396
CO'RTISUS	thiflorus	■	Spain	-	-	395	
EDWY'RDZIA	Macnabiana	■	-	-	-	46†	
†EYSENHARTIA	†amorphoides	? ■	Mexico	-	-	395	
†GEO'LOGIUM	versicolor	■ □	Swan River	-	-	521 †395	
†GONGENS		■ □	K.G.S.	-	-	395	
†HARRISII		■ □	Mexico	-	-	520	
†ISOTROPIS	†striata	? ■	Swan River	-	-	395	
KENNE'DYA	coccinea	■ □	New Holland	-	-	395	
LUPINUS	*Barkeri	○ □	Mexico	-	-	596	
	*Hartwegii	○	Mexico	-	-	395	
MEDICA'GO	†clypeata		North of India	-	-	521	
MIRBE'LLA	Bàxteri	■ □	New Holland	-	-	243	
<i>Portulac'eæ.</i>		COTYLEDON	Sempervivum	£ △	E. Caucasus	-	559
<i>Crassul'eæ.</i>			syn. Umbilicus Sempervivum				
<i>Cact'eæ.</i>		ECHINOCA'TUS	*Scopa	■ □	Brazil	-	396
<i>Compos'iteæ.</i>		EPIPHY'LLUM	*Russellianum	£ □	Brazil	-	243
†APLOTA'XIS	†albescens	£ ? □	India	-	-	597	
*BURRI'LLA	*gracilis	○	California	-	-	597	
CENTAURE'A	†pulehra	○	North of India	-	-	46†	
CINERA'RIA	lacteà	■ □	Canary Isles	-	-	521	
DA'LLIA	scapigera	£ △	Mexico	-	-	597	
EURY'BIA	†glutinosa	? ■	V. D. L.	-	-	559	
LASTHENIA	glabrata	○	California	-	-	396	
RUDBE'CKIA	*Drummondii	£ △	?N. America	-	-	244	
†SENE'CIO	†odoratus	£ △	New Holland	-	-	559	
	†populifolius		Canary Isles	-	-	521	
<i>Campanulac'eæ.</i>		†CODONOP'SIS	†lurida	■ □	India	-	597
<i>Gesner'eæ.</i>		GE'SNERA	elongata	■ □	-	-	396
<i>Gesner'eæ.</i>			*fruticosa	■ □	-	-	396

Ges. Márchii ✱ □ Organ Mts. - - 521	
*stricta ✱ □ South Brazil - - 464	
<i>Epacridiææ.</i>	
E'PACRIS.	
*coccineus ✱ □ hybrid - - 464	
impressa	
var. *parviflora ✱ □ New Holland - 244	
<i>Asclepiadææ.</i>	
CEROPE'GIA	
*vinæfolia ☞ □ Bombay - - 465	
HOY'A	
*coriacea ? ✱ □ Manila - - 244	
<i>Gentianææ.</i>	
GENTIA'NA verna	
var. *álba ✱ □ - - - - 597	
<i>Cyrtandracææ.</i>	
ÆSCHYNA'NTHUS	
*ramosissimus ✱ □ Khoseea - 597	
<i>Bignoniææ.</i>	
BIGNO'NIA	
jasminoides ✱ □ Moreton Bay - 597	
syn. <i>Tecoma</i> jasminoides G. Don.	
<i>Sesamææ.</i>	
TOURRE'TTIA	
lappæca ✱ □ Peru - - 559	
<i>Convolvulææ.</i>	
IPOME'A	
†longifolia ✱ □ - - - - 559	
<i>Boraginææ.</i>	
CYNOGLO'SSUM	
*caelestineum ✱ □ North of India - 465	
†glochidiatum ✱ □ India - - 598	
ONO'SMA	
setosum ✱ □ Russia - - - - 521	
<i>Solanææ.</i>	
SOLA'NUM	
†candidum ✱ □ Mexico - - 559	
<i>Scrophulariææ.</i>	
ANGELO'NIA	
*Gárdneri ✱ □ Pernambuco - 598	
LINA'RIA	
delphinoides □ Russia - - 559	
PENTSTEMON barbatus	
var. *cárneus ✱ □ Mexico - - 245	
VERO'NICA.	
? *diosmæfolia ✱ V. D. L. - 465	
†formosa ✱ V. D. L. - - 465	
<i>Labiátæ.</i>	
NE'PETA	
salvæfolia ✱ □ Himalayas - - 560	
SA'LVIA	
argentea ✱ □ Crete - - - - 521	
†confertiflora ? □ Rio Janeiro - 396	
†Moorcroftiana ✱ □ India - - 598	
<i>Verbenææ.</i>	
VERBE'NA	
*officináli-vendsa ✱ □ hybrid - 598	
<i>Myoporinææ.</i>	
STENOCHI'LUS	
†incanus ✱ □ New Holland - - 560	
longifolius ✱ □ New Holland - 560	
<i>Acanthææ.</i>	
†ASTERACA'NTHA	
†longifolia ✱ □ Egypt - - - - 560	
RUE'LLIA	
†ciliatiflora ? ✱ □ Buenos Ayres - 245	
THUNBE'RGIA	
Hawtayneana ✱ □ Nepal - - 521	
<i>Amaranthææ.</i>	
*TRICHI'NIUM	
*alopecuróideum □ New Holland - 396	
<i>Begoniææ.</i>	
BEGO'NIA	
parvifolia ✱ □ C. G. H. - - 245	
*sinuata ✱ □ - - - - 396	
<i>Polygonææ.</i>	
POLY'GONUM	
amplexicaule ? ✱ □ India - - 521	
<i>Proteææ.</i>	
GREVI'LLIA	
†Thelemoniana ✱ □ New holland 465	
<i>Thymelæææ.</i>	
PIMELE'A	
Hendersoni ✱ □ K. G. S. - - 245	
†prostrata ✱ □ New Zealand - 465	
<i>Aristolochiææ.</i>	
ARISTOLO'CHIA	
*hyperborea ☞ □ ? India - - 245	
<i>Urticææ.</i>	
GALACTODE'NDRON	
útile ♀ □ Caraccas - - - 396	
<i>Orchidææ.</i>	
†AGANI'SIA	
†pulchella ✱ □ Demerara - - 399	
ANGRÆCUM	
†arniacum ✱ □ Sierra Leone - 560	
*crumenatum ✱ □ Ceylon - - 247	
BLE'TIA	
*Parkinsoni ✱ □ Mexico - - 465	
†ankervillæ ✱ □ China - - 247	
BRASAVO'LA	
*cuspidata ✱ □ Trinidad - - 247	
†glauca ✱ □ Vera Cruz - - 399	
BURLINGTO'NIA	
*maculata ✱ □ Brazil - - - 522	
CATTLE'YA	
citrina ✱ □ Mexico - - - 521	
Gráhami ✱ □ Mexico - - - 398	
†superba ✱ □ British Guiana - 399	
CIRRHE'A	
fusco-lutea ✱ □ Brazil - - - 398	
†saccata ✱ □ - - - - 561	
CIRRHOPÉ'TALUM	
†fimbriatum ✱ □ Bombay - - 561	
†nutans ✱ □ Manila - - - 560	
CÆLO'GYNE	
Gardneriana ✱ □ Khoseea - 399	
†ocellata ✱ □ India - - - 247	
CORY'NTHES	
maculata	
var. *Parkeri ✱ □ - - - 560	
CYMBIDIUM	
†bicolor ✱ □ Ceylon - - - 399	
†tridifolium ✱ □ - - - 247	
CYRTOCHI'LUM	
†stellatum ✱ □ - - - 399	
DENDRO'BUM	
*amœnum ✱ □ Nepal - - - 561	
aëreum	
var. *pállidum ✱ □ Ceylon - - 247	
†bicameratum ✱ □ India - - - 522	
†Caleyi ✱ □ Illawarra - - - 247	
†complanatum ✱ □ - - - 248	
†crassæfolium ✱ □ Blue Mntns. - 248	
*crumenatum ✱ □ Ceylon - - 247	
†elongatum ✱ □ Brisbane River - 248	
formosum ✱ □ Khoseea - - - 247	
†Heyneanum ✱ □ Bombay - - 398	
*Jenkinsii ✱ □ Gualpra - - - 465	
†linguæforme ✱ □ N. S. W. - - 247	
†macrophyllum ✱ □ Manila - - 398	
†Páxtoni ✱ □ Khoseea - - - 398	
*Páxtoni ✱ □ Pondooah - - - 561	
†pugioniforme ✱ □ Illawarra - 248	
†pygmaeum ✱ □ Illawarra - - 247	
†teretifolium ✱ □ N. S. W. - - 247	
†tetragonum ✱ □ Moreton Bay - 247	
†tortile ✱ □ Moreton Bay - - 247	
†DICHÆ'A	
†ochracea ✱ □ Demerara - - - 466	
EPIDE'NDRUM	
†Candollei ✱ □ Mexico - - - 466	
†glumaceum ✱ □ Brazil - - - 399	
E'RIA	
*ferruginea ✱ □ Calcutta - - 398	
GONGO'RA	
*fúlva ✱ □ Mexico - - - 560	
†nigrita ✱ □ - - - 522	
GOO'DERA	
†rubicunda ✱ □ Manila - - - 522	
syn. <i>Neottia rubicunda</i> Blume.	
GOVE'NIA	
†lagenophora ✱ □ - - - 399	

ISOCHR'LUS	†hividus	£	☒	Mexico	-	-	-	398
LE'LLA	†albida	£	☒	Oaxaca	-	-	-	599
	†autumnalis	£	☒	Mexico	-	-	-	398
	*†furfuracea	£	☒	Mexico	-	-	-	398
	†majalis	£	☒	Mexico	-	-	-	398
LEPTO'TES bicolor	var. *†glaucophylla	£	☒	Organ Mts.	-	-	-	398
†MALACHE'NIA	†clavata	£	☒	Rio Janeiro	-	-	-	560
MAXILLA'RIA	†lentiginosa	£	☒	Brazil	-	-	-	522
MORMO'DES	†pardina	£	☒	Oaxaca	-	-	-	522
OCTOME'RIA	†tridentata	£	☒	Demerara	-	-	-	398
ODONTOGLO'SSUM	†cordatum	£	☒	Mexico	-	-	-	399
	*†Róssi	£	☒	Mexico	-	-	-	560
ONCI'DIUM	*†côncolor	£	☒	Organ Mountains	-	-	-	560
	†luridum	£	☒		-	-	-	
	var. *†Henchmâni	£	☒	Mexico	-	-	-	246
	†papilio	£	☒		-	-	-	
	var. *†himbâtum	£	☒		-	-	-	398
	†pulvinatum	£	☒	Brazil	-	-	-	522
	*†reflexum	£	☒	Mexico	-	-	-	246
	†sanguineum	£	☒	La Guayra	-	-	-	398
	*†trulliferum	£	☒	Brazil	-	-	-	599
	†unicôrne	£	☒	Rio	-	-	-	466
ONY'CHIUM	*†crumenatum	£	☒	Ceylon	-	-	-	247
PHA'IUS	†bicolor	£	☒	Ceylon	-	-	-	522
	†grandifolius	£	☒	China	-	-	-	247
	*†Wallichii	£	☒	Khoseca	-	-	-	599
PHOLIDO'TA	†articulata	£	☒	India	-	-	-	399
POLYSTA'CHYA	†affinis	£	☒	Sierra Leone	-	-	-	398
SACCOLA'BHUM	†calceolare	£	☒	Khoseca	-	-	-	399
	†micranthum	£	☒		-	-	-	399
SARCOCHI'LUS	†olivaceus	£	☒	New Holland	-	-	-	247
SATY'RIUM	*†erectum	£	☒	C. G. H.	-	-	-	399
SCAPHYGLO'TTIS	†stillata	£	☒	Demerara	-	-	-	399
SCHOMBU'RCKIA marginata	var. *†petalis sepalisque immarginatis	£	☒	Surinam	-	-	-	398

STANHO'PEA	*†maculosa	£	☒	Mexico	-	-	-	599
	†oculata	£	☒		-	-	-	
	var. †Barkeridna	£	☒	Mexico	-	-	-	560
TRIGONI'DIUM	†tenuis	£	☒	Trinidad	-	-	-	398
VA'NDA	†congôsta	£	☒	Ceylon	-	-	-	522
	Iridæcæ.							
CRO'CUS	*†speciosus	£	☒	Britain	-	-	-	466
GLADI'OLUS	*†ramosus	£	☒	C. G. H.	-	-	-	399
	Hemodoræcæ.							
CONO'STYLIS	†juncea	£	☒	New Holland	-	-	-	466
	Amaryllidæcæ.							
AGA'VE	†Saponaria	£	☒	Peru	-	-	-	598
ALSTRÆME'RIA	*†acutifolia-aurea	£	☒	hybrid	-	-	-	598
COOPE'RIA	†pedunculata	£	☒	Texas	-	-	-	400
SCEPTRA'NTHUS	†Drummôndi	£	☒	Texas	-	-	-	400
	Asphodelæcæ.							
DAUBE'NYA	*†fulva	£	☒	Madagascar	-	-	-	599
	Liliæcæ.							
*BE'SSERA	*†elegans	£	☒	Mexico	-	-	-	400
LI'LIUM	†aurantium	£	☒	Italy	-	-	-	466
	†Thunbergianum	£	☒	Japan	-	-	-	466
	Tulipæcæ.							
FRITILLA'RIA	†racemosa	£	☒	Pyrenees	-	-	-	561
	Melanthæcæ.							
*ASAGRE'A	*†officinâlis	£	☒	Mexico	-	-	-	400
HELO'NIAS	†officinâle	£	☒	Mexico	-	-	-	400
VERA'TRUM	*†officinâle	£	☒	Mexico	-	-	-	400
	Arôidæcæ.							
CALA'DIUM	†petiolatum	£	☒	Fernando Po	-	-	-	400
	†seguinum	£	☒	America	-	-	-	400
	syn. Dieffenbâchia seguina							

## LIST OF PLANTS.

### MENTIONED OR TREATED OF IN THE PRESENT VOLUME.

List of Plants which suffered during the Winter of 1837-38 in the Oxford Botanic Garden	57
List of Plants which suffered during the Winter of 1837-38 at Munich	61
Baron von Karwinski's Catalogue of Mexican Cacti	156
A List of the Plants introduced into the Garden of Desio, near Milan	191
List of Trees, Shrubs, and Plants cultivated in the Handsworth Nursery, with the Effects of the Winter of 1837-38 on them	231
List of the Coniferæ described in the <i>Pinetum Woburnense</i>	266-275
Baron de Serret's List of Coniferous Trees in his Pinetum at Beernem, near Bruges	326
Alphabetical List of Sorts of Cratægus in the	

Arboretum of Messrs. Loddiges, as given in their Catalogue for 1836; with some Additions	413
Alphabetical List of the Species and Varieties of Cratægus described in the <i>Arboretum Britannicum</i> , with the Names which are appended to the Specimen Plants of these Sorts in the Arboretum of Messrs. Loddiges	414
List of Plants introduced during the Year 1838 into the Garden of M. Ulrich, at Milan	420
Mr. M'Nab's List of Plants for growing in a portable Conservatory	487
Mr. Cameron's List of Trees that have rapidly attained a large size in the Birmingham Botanic Garden	538

<i>Abies cephalonica</i> 126. 130. 265	<i>Ab. excelsa</i> - - - 225	<i>Ab. Pinsapo</i> - - - 163
(see <i>Picea cephalonica</i> .)	<i>Menziésii</i> - - - 265	<i>religiosa</i> - - - 626
<i>communis</i> var. <i>pendula</i> 130.	<i>nobilis</i> - - - 265	<i>Smithiana</i> - - - 265
<i>Douglâsii</i> 264, 265. 370. 429.	<i>orientalis</i> - - - 225	<i>Webbiana</i> - - - 583
557. 667	<i>pectinata</i> - - - 201	<i>Abutilon striatum</i> - - - 395





<i>Elichrysium spectabile</i> - 430	<i>Escallonia glandulosa</i> - 577	<i>Gánnera integrifolia</i> - 693
<i>Elymus geniculatus</i> - 471	<i>rubra</i> - 577	<i>Gymnócladus canadensis</i> - 67
<i>Enkiánthus quinquefidus</i> - 368	<i>Eucalyptus alpina</i> - 575	<i>Gypsocalis carneá</i> - 59
<i>Epacris ceriflora</i> - 199	<i>Eugenia Jambos</i> - 250. 332	vágnans - 59
coccineus - 464	Michèlii - 332	<i>Halésia diptera</i> - 60
heteronema - 430	pedunculata - 332	<i>Hedýchium</i> sp. - 531
impressa - 199	<i>Euonymus europæus</i> - 281	<i>Heimia salicifolia</i> - 577
var. parviflora - 244	<i>Euphórbia amygdaloides</i> - 124	<i>Helianthemum caput felis</i> - 338
nivalis - 199	Charácias - 124	guttátum - 183
pulchella - 199	Jacquiniæflora - 199	Tuberaria - 183
pungens - 199	palustris - 124	<i>Helianthus mollis</i> - 72
rosea - 199	speciosa - 430	<i>Helicónia bicolor</i> - 80
variabilis - 199	splendens - 583	<i>Helichrysium macranthum</i> 72
<i>Epidéndrum alatum</i> - 46	veneta - 124	scorpioides - 45
calamáríum - 79	<i>Eurybia glutinosa</i> - 589	<i>Heracléum granatense</i> - 339
Candollæi - 466	<i>Eysenhardtia amorphoides</i> - 359	<i>Sphondylium</i> - 339
cochleátum - 207	<i>Fabiána imbricata</i> - 430	<i>Heterótropa asaroides</i> - 521
crassifolium - 581	Fagus obliqua - 693	<i>Hibiscus Cameróni</i> - 70
glumáceum - 399	<i>Férula neapolitana</i> - 67	esulentus - 102. 330
macrochilum - 46	tingitana - 67	Pattersónii - 41
primulinum - 43. 45	<i>Festuca Clemenæi</i> - 339	syriacus - 67
Skinneri - 578	álegans - 340	<i>Hippocrépis prostrata</i> - 338
tibicinis - 421	granatensis - 340	<i>Hippómane Mancinella</i> - 155
uniúform - 136	indigesta - 340	<i>Hippophae Rhamnoides</i> - 124
<i>Epigæa repens</i> - 145	Pseudoeskia - 340	<i>Holzia mexicana</i> - 46. 300
<i>Epilóbium hirsutum</i> - 37	rivularis - 340	<i>Hólcus caspius</i> - 339
<i>Epimedium Muschiánnum</i> - 520	<i>Ficaria grandiflora</i> - 184	<i>Hoteia japonica</i> - 45
<i>Epiphyllum Altensteini</i> - 86	ranunculoides - 184	<i>Hovea crispá</i> - 243
Russellianum - 243	<i>Ficus Cárca</i> - 60	Manglesi - 70
speciosissimum - 192	religiosa - 253	pungens - 395
truncátum - 86	stipulata - 319	<i>Hóya coriacea</i> - 244
<i>Epithëcia glauca</i> - 77	<i>Fontanèsia phillyreoides</i> - 60	<i>Huntleya melægris</i> - 246
<i>Ergotætea abórtans</i> - 170	<i>Fráxinus excelsior</i> 123. 571	violacea - 246
<i>Eria ferruginea</i> - 398	excelsior pëndula ad- pressa - 124	<i>Hura crépitans</i> - 145
<i>Eria abietina</i> - 117	lentiscifolia - 123. 575	<i>Hydrangea Horténsia</i> quercifolia - 67
acuminata - 402	oxycarpa - 123	<i>Hydrástis canadensis</i> - 260
arboREA - 184	oxyphylla - 123	<i>Hypéricum dentatum</i> - 184
<i>Archèria</i> - 402, 403	rostrata - 123	lyssopifolium - 243
árdens - 402	<i>Fritillaria racemosa</i> - 561	Kalmianum - 260
beflor - 403	<i>Fúchia Brewsterii</i> - 430	<i>Ilex balearica</i> - 576
<i>Bowléana</i> - 402	cyliodræca - 70. 480	<i>Illicium anisatum</i> - 575
caffra - 402	fúlgens - 47. 430. 530	floridum - 121. 575
carinata - 402	fúlgida superbá - 530	<i>Impatiens biflora</i> - 260
cerinthoides superbá - 402	globosa - 430	sp. - 626
concinna - 402	globosa maior - 430	<i>Inga Harrisii</i> - 580
<i>Coventryana</i> - 402	gracilis - 59	<i>Ionopsis tères</i> - 80
cyliodræca - 402	grandiflora - 530	<i>Ipomæa Batatas</i> - 193. 520
<i>Eweriana</i> - 402	grandiflora máxima - 530	Horsfallæ cult. - 161. 347
floribanda - 403	longiflora - 59	<i>Jalapa</i> longifolia - 559
fúlgida - 403	majestica - 530	macrorhiza - 329
gracilis - 402, 403	multiflora erecta - 530	tyriánthina - 74
grandiflora - 402, 430	pëndula terminalis - 530	<i>Isóchilus lívidus</i> - 398
grandinosa - 403	stylisa conspicua - 530	Isótropis striata - 395
hirsuta - 403	<i>Fumaria sempervirens</i> - 182	<i>Jacquinia ruscifolia</i> - 145
hirta - 402	<i>Galactodendron útile</i> - 187. 396	<i>Jasione amethystinus</i> - 339
hybrida maior - 402	Galánthus plicatus - 297	humilis - 339
ignescens - 403	<i>Galphimia glauca</i> - 400	<i>Jasminum fruticosum</i> officinale - 60
<i>Linnæana</i> - 402	<i>Gardoquia betonicoides</i> - 75	revolutum - 60
mammosa - 402	<i>Gárrya laurifolia</i> - 147	<i>Játropha Manihot</i> - 329
muscaria - 430	<i>Gaulthèria Sháillon</i> - 456	<i>Jeffersonia diphylla</i> - 260
mutabilis - 402	<i>Gazania regina</i> - 430	<i>Juglans arguta</i> - 254
odora rosea - 402	<i>Genipa americana</i> - 332	nigra - 318. 574
pellucida - 402	<i>Gentiána nítida</i> - 399	regia - 574
persoluta - 403	Pneumonánthe var. - 339	<i>Júnco serratus</i> - 343
perspicua - 430	vérna var. álba - 597	<i>Juniperus chinensis</i> - 575
perspicua nana - 402	<i>Geranium tuberosum</i> var. ramosum - 135	fiacida - 241
prægnans - 402	<i>Gesneria elongata</i> var. fru- tidosa - 396	florida - 130
propèndens - 402	Márcii - 521	mexicana - 130. 241
pseudovestita - 74	scæptrum - 430	recúrva - 576
scabridiscula - 402	stricta - 464	<i>Oxycedrus</i> - 576
scoparia - 184	<i>Gladiolus ramosus</i> - 399	prostrata - 67
tricolor var. superbá - 135	<i>Glaucium rubrum</i> - 464	<i>Sabina repens</i> - 370
tubiflora - 430	<i>Gleditschia macracantha</i> - 117	squamosa - 248
umbellata - 402	triacanthos - 318. 416	tetragona - 130. 241
ventricosa - 402	<i>Gloxinia máxima</i> - 73	virginiana - 67. 241
ventricosa álba - 430	<i>Glycine sínensis</i> - 575	<i>Kálmia latifolia</i> - 326
ventricosa erecta - 430	<i>Gompholóbium versicolor</i> 395. 521	pumila - 326
vérnix coccinea - 402	Gongóra fúlva - 560	<i>Kennèdyia coccinea</i> - 395
versicolor - 402	nigrita - 522	<i>Kùhnia eupatorioides</i> 144. 472
verticillata nova - 402	<i>Goodyera rubicunda</i> - 522	<i>Költreutèria paniculata</i> 303. 575
vestita - 402	<i>Govènia lagenophora</i> - 399	<i>Lælia álvida</i> - 78. 578. 599
viridiflora - 205	<i>Grevillea rosmarinifolia</i> 308. 575	autumnalis - 398
<i>Eryngium glaciæ</i> - 389	Thelemoniâna - 465	furfuræca - 398
<i>Eriobotrya japonica</i> - 376		<i>Lagerstrœmia indica</i> - 193. 511
<i>Erophila vulgaris</i> - 193		
<i>Erysimum Perowskianum</i> 243		





<i>Pholidota articulata</i> - - - 399	<i>Pl. pumilio</i> - - - 126. 518	<i>Pr. Rhamburei</i> - - - 338
<i>Phormium tenax</i> 41. 183. 575	<i>pyrenæica</i> - - - 125. 163. 164	<i>serotina</i> - - - 67
<i>Phytinia serrulata</i> - - - 59. 193	<i>religiøsa</i> - - - 128	<i>spinosa</i> - - - 338
<i>Phylla plumosa</i> - - - 342	<i>rigensis</i> - - - 518	<i>Psidium pyrifenum</i> - - - 332
<i>Phyllocladus rhomboidalis</i> - 41	<i>rigida</i> - - - 67. 265	<i>Ptilotrichum longicaule</i> - - - 338
<i>Physalis pubescens</i> - - - 343	<i>rùbra</i> - - - 518	<i>purpureum</i> - - - 338
<i>Phytëuma Hållerii</i> - - - 135	<i>Sabiniana</i> - - - 265. 429. 459	<i>Punica Granatum</i> - - - 511
<i>Picea amabilis</i> - - - 459	<i>sinensis</i> - - - 370	<i>Pyrus Aronia</i> - - - 511
<i>balsamea</i> - - - 188	<i>Stròbus</i> - - - 67. 129. 265	<i>aucuparia</i> - - - 261
<i>bracteata</i> - - - 193	<i>sylvëstris</i> 125. 126. 127. 201.	<i>parvifolius</i> - - - 60
<i>cephalonica</i> - - - 238	224. 228. 264. 265	<i>Quadrà heterophylla</i> - - - 693
<i>grândis</i> - - - 459	<i>argentea</i> - - - 228	<i>Quekëttia microscopica</i> - - - 78
<i>maritima</i> - - - 109	<i>europæa</i> - - - 228	<i>Quercus Ægilops</i> - - - 258. 590
<i>nobilis</i> - - - 193. 459	<i>genevënsis</i> - - - 228. 499	<i>alpëstris</i> - - - 339
<i>Nordmanni</i> - - - 131	<i>β hamata</i> - - - 228	<i>austriaca</i> - - - 590
<i>orientalis</i> - - - 227	<i>uncinata</i> - - - 125. 126	<i>aquatica</i> - - - 193
<i>pectinata</i> - - - 109. 667	<i>gállica</i> - - - 228	<i>Ballota</i> - 184. 256. 258. 590
<i>Pinsapo</i> 109. 187. 238. 339	<i>Tædia</i> - - - 518	<i>Banisteri</i> - - - 510
<i>vulgæris</i> - - - 228	<i>taurica</i> - - - 125. 224. 228	<i>brütia</i> - - - 591
<i>Webbiana</i> - - - 370. 459	<i>Teocote</i> - - - 128. 626	<i>Cërris</i> - - - 590
<i>Pimelea Hendersoni</i> - - - 245	<i>Piptanthus nepalënsis</i> - - - 58	<i>Lucombeana</i> - - - 60
<i>hispidà</i> - - - 430	<i>Pistacia Lentiscus</i> - - - 99	<i>coccifera</i> - 318. 590. 621
<i>prostrata</i> - - - 465	<i>Terebinthus</i> - - - 576	<i>coccinea</i> - - - 195
<i>rosea</i> - - - 430	<i>Pisum maritimum</i> - - - 47	<i>crinata</i> - - - 590
<i>Pinus A'bies</i> - - - 227. 265	<i>sativum</i> - - - 499	<i>E'sculus</i> - - - 424
<i>altàica</i> - - - 518	<i>Pittòsporum Tobira</i> - - - 47. 575	<i>gramuntia</i> - - - 590
<i>argentea</i> - - - 225	<i>viridiflorum</i> - - - 342	<i>glomerata</i> - - - 591
<i>austriàlis</i> - - - 236	<i>Plànera Richárdi</i> - - - 67	<i>Alex</i> - 60. 61. 184. 318. 513.
<i>Ayacahuite</i> - - - 128. 129	<i>Plantago lanceolata</i> - - - 343	<i>infectoria</i> - - - 590
<i>balsamea</i> - - - 67. 226	<i>Platanus occidentalis</i> - 318. 511	<i>lusitanica</i> - - - 590
<i>Banksiana</i> - - - 667	<i>orientalis</i> - 61. 98. 318. 511	<i>montana</i> - - - 510
<i>brütia</i> - - - 576	<i>Platysëmon californicus</i> - 67	<i>palustris</i> - - - 510
<i>canadënsis</i> - - - 67	<i>leiocarpus</i> - - - 69	<i>pedunculata</i> - - - 258. 512
<i>canariënsis</i> - - - 255. 670	<i>Pleurothälis bicarinata</i> - 136	<i>pyramidalis</i> - - - 119
<i>Cembra</i> - 61. 126. 265.	<i>muscoidæa</i> - - - 78	<i>variegata</i> - - - 513
518	<i>pectinata</i> - - - 78	<i>Phellos</i> - - - 424
<i>Coultërii</i> - 265. 429. 459	<i>stenopétala</i> - - - 78	<i>pseudo-coccifera</i> - - - 590
<i>devoniàna</i> - - - 626	<i>strupifolia</i> - - - 78	<i>Pseudò-Süber</i> - - - 339
<i>Escarëna</i> - - - 127	<i>Pòa annua</i> - - - 488	<i>Ròbur</i> - - - 590
<i>excelsa</i> - 255. 265. 459. 667	<i>Podocarpus latifolius</i> - 255	<i>rùbra</i> - - - 195
<i>genevënsis</i> - - - 518	<i>macrophyllus</i> - - - 255	<i>sessiliflora</i> - - - 512
<i>Gerardiana</i> - - - 670	<i>faxifolius</i> - - - 187	<i>Süber</i> - - - 60. 255. 621
<i>halépënsis</i> - 61. 130. 201. 224.	<i>Podophyllum peltatum</i> - 260	<i>Tæza</i> - - - 591
228. 258	<i>Polemonium caruleum</i> - 182	<i>trojana</i> - - - 590
<i>Hartwegii</i> - - - 626	<i>mexicanum</i> - - - 67	<i>vininalis</i> - - - 591
<i>hirtëlla</i> - - - 128	<i>puchellum</i> - - - 67	<i>Ranunculus montanus</i> - 338
<i>hispanica</i> - - - 125	<i>Polygonum amplexicaule</i> 521.	<i>Repanthera coccinea</i> - - - 480
<i>horizontalis</i> - - - 518	534	<i>Reseda luteola</i> - - - 281
<i>inops</i> - - - 518. 667	<i>tinctorum</i> - - - 163	<i>Rëutera gracilis</i> - - - 339
<i>insignis</i> - 459. 577. 670	<i>Polystachya affinis</i> - - - 398	<i>procumbens</i> - - - 339
<i>intermedia</i> - - - 518	<i>grandiflora</i> - - - 137	<i>Rhàmnus arabicus</i> - - - 610
<i>Lambertiana</i> - - - 265. 459	<i>lutëola</i> - - - 81	<i>latifolius</i> - - - 58
<i>Laricio</i> - 67. 163. 224. 228.	<i>zeylanica</i> - - - 81	<i>opulifolius</i> - - - 39
236. 518	<i>Pomaderris prunifolia</i> - 432	<i>Pulassii</i> - - - 39
<i>hispanica</i> - - - 125	<i>Ponera graminifolia</i> - 136	<i>Wicklius</i> - - - 39
<i>leiophylla</i> - - - 129. 577	<i>Pòpulus acledésca</i> - - - 629	<i>Rhëum hybridum</i> - - - 44
<i>Llaveana</i> - - - 128. 530	<i>álba</i> - - - 254. 318	<i>Rhëpsalis Cassythæ</i> - - - 157
<i>mariana</i> - - - 67	<i>angulata</i> - - - 670	<i>Rhododëdron anthropegon</i> 254
<i>maritima</i> - 101. 228. 258.	<i>ciliata</i> - - - 254. 255	arboreum - 198. 234. 529
279	<i>dilatata</i> - - - 254	<i>campanulatum</i> - - - 576
<i>máxima</i> - - - 579	<i>fastigiata</i> - - - 120. 192. 254	<i>catawbiense</i> - 44. 45. 234
<i>minor</i> - - - 579	<i>græca</i> - - - 116	<i>caucasicum</i> - - - 234
<i>monspeliënsis</i> - - - 228	<i>monilifera</i> - 433. 512. 629	<i>lepidotum</i> - - - 254
<i>Montezuma</i> - - - 129	<i>nigra</i> - - - 255	<i>máximum</i> - - - 234. 325
<i>monticola</i> - - - 265. 459	<i>pyriformis</i> - - - 254	<i>põnticum</i> - - - 234. 325
<i>Mughus</i> - - - 126	<i>Portulaca grandiflora</i> var.	<i>punctatum</i> - - - 325
<i>nepalënsis</i> - - - 255	<i>rütia</i> - - - 559	<i>Smithii</i> - - - 222
<i>nigra</i> - - - 228	<i>Potentilla ambigua</i> - - - 233	<i>Rhùs Coriaria</i> - - - 66
<i>nigricans</i> - - - 130	<i>feruginea</i> - - - 70	<i>Còtinus</i> - - - 66
<i>Nordmanniana</i> - - - 225	<i>geranioides</i> - - - 338	<i>vërnix</i> - - - 66
<i>ocarpa</i> - 128. 129. 237. 240.	<i>hamatoceros</i> - - - 597	<i>Ribes aureum</i> - - - 59
248	<i>nevadënsis</i> - - - 338	<i>glutinodum</i> - - - 59
<i>orientalis</i> - - - 224	<i>Pourrëtia rubicaulis</i> - - - 202	<i>malvaceum</i> - - - 59
<i>Pallasiana</i> - - - 228	<i>Prangos pabularia</i> - - - 533	<i>opulifolium</i> - - - 39. 630
<i>palustris</i> - - - 670	<i>Prepus connata</i> - - - 187	<i>sanguineum</i> - 59. 66. 350.
<i>pátula</i> - - - 128. 626	<i>Primula sinensis</i> - - - 614	630
<i>pectinata</i> - - - 265. 296	<i>Prøtea compacta</i> - - - 569	<i>Richárdia africanà</i> - - - 577
<i>pèrsica</i> - - - 130	<i>longiflora</i> - - - 569	<i>Ricinus communis</i> - - - 281. 343
<i>Pinea</i> - 101. 201. 224. 227.	<i>melifera</i> - - - 343. 569	<i>Robùna Pseud-Acacia</i> - 114
518	<i>Múndii cult.</i> - - - 569	<i>Ròella elegans</i> - - - 244
<i>Pinaster</i> - 67. 127. 201. 228.	<i>Prùnus Capóltim</i> - - - 147. 160	<i>Ròhdeæ japonica</i> - - - 67
255. 253. 265. 579. 621	<i>Coccolilla</i> - - - 122	<i>Ròsa alabàndica</i> - - - 380
<i>Pinaster Aberdoniæ</i> - 123	<i>domestica</i> - - - 261	<i>cinnamòmea</i> - - - 382
<i>Pinsapo</i> - - - 201	<i>myrobàlana</i> - - - 123	<i>Banksiæ</i> - - - 234
<i>pityùsa</i> - - - 130. 228	<i>nigra</i> - - - 67	<i>bracteata</i> - - - 58
<i>ponderòsa</i> - 265. 429. 459	<i>prostrata</i> - - - 66	<i>campàna</i> - - - 380
<i>Pseudo-Stròbus</i> - - - 626	<i>pùmila</i> - - - 66	

<i>Röd. canina</i> - - - 381, 382	<i>Séseli buchtorménsé</i> - - - 67	<i>Trifolium hybridum</i> - - - 163
<i>centifolia</i> - - - 380	<i>gummiferum</i> - - - 67	<i>rèpens</i> - - - 202
<i>dahùrica</i> - - - 478	<i>intrinsicum</i> - - - 339	<i>Trigonidium acuminatum</i> - - - 81
<i>Eglantéria</i> - - - 382	<i>Sinapis pekinénsis</i> - - - 162	<i>Egertonianum</i> - - - 81
<i>gállica</i> - - - 185	<i>Sisyrinchium júnceum</i> - - - 248	<i>ténue</i> - - - 398
<i>indica</i> - - - 254	<i>Solanum bonariénsé</i> - - - 60	<i>Trisetum glaciale</i> - - - 359
<i>microphylla</i> - - - 58	<i>cándidum</i> - - - 559	<i>velutinum</i> - - - 339
<i>moschata</i> - - - 59	<i>Herbertianum</i> - - - 74	<i>Tropeæ olum tuberosum</i> - - - 162
<i>multiflora álba</i> - - - 59	<i>Lycopersicum</i> - - - 102, 262	<i>tricolorum</i> - - - 430
<i>prænestina</i> - - - 380	<i>Sóllya heterophylla</i> - - - 575	<i>Tuber cibarium</i> - - - 192
<i>milésia</i> - - - 380	<i>lineàris</i> - - - 472	<i>griseum</i> - - - 193
<i>rubifolia</i> - - - 59	<i>Sophora japónica</i> - - - 67, 124	<i>Typha latifolia</i> - - - 343
<i>rubiginosa</i> - - - 382	<i>péndula</i> - - - 122	<i>Ulex provincialis</i> - - - 338
<i>semperflorens</i> - - - 58	<i>Sophrontis grandiflora</i> - - - 138	<i>stricta</i> - - - 119
<i>sempervirens</i> - - - 59	<i>Sórbus Ária</i> - - - 338	<i>Ulmus campestris</i> - - - 571
<i>spinèola</i> - - - 380	<i>Spiræa ariæfolia</i> - - - 67	<i>campestris cornubiensis</i> 460
<i>sylvestris</i> - - - 381, 382	<i>barbata</i> - - - 45	<i>erdsa</i> - - - 254
<i>trachina</i> - - - 380	<i>bélla</i> - - - 67	<i>fólva</i> - - - 574
<i>Rosæda purpurea</i> - - - 260	<i>cuneifolia</i> - - - 521	<i>integrifolia</i> - - - 254
<i>Rosmarinus officinalis</i> - - - 60	<i>japónica</i> - - - 45	<i>lævigata</i> - - - 254
<i>Rubus æreticus</i> - - - 37	<i>laxiflora</i> - - - 521	<i>lanatifolia</i> - - - 254
<i>Rudbeckia amplexifolia</i> - - - 214	<i>oblongifolia</i> - - - 58	<i>macrophylla</i> - - - 113
<i>Ruellia ciliatiflora</i> - - - 245	<i>vacciniifolia</i> - - - 521	<i>maculata flava</i> - - - 113
<i>Ruscus aculeatus</i> - - - 61	<i>Spòndias tuberosa</i> - - - 392	<i>montana</i> - - - 449
<i>laxus</i> - - - 61	<i>Spongilla fluviatilis</i> - - - 176	<i>pyramidalis</i> - - - 113
<i>racemosus</i> - - - 61	<i>Stanhøpea insignis</i> - - - 202, 204	<i>virgata</i> - - - 254
<i>Saccolabium ampullaceum</i> 337	<i>maculosa</i> - - - 599	<i>Urceolina pèndula</i> - - - 82
<i>calceolare</i> - - - 399	<i>oculata</i> - - - 205	<i>Urtica dioica</i> - - - 617
<i>micranthum</i> - - - 399	<i>Barkeriana</i> - - - 560	<i>Uvularia mexicana</i> - - - 117
<i>Sanguinaria canadensis</i> 260	<i>tigrina</i> - - - 76	<i>Vaccinium ovatum</i> - - - 577
<i>Salisburia adiantifolia</i> - 60, 67,	<i>Wardii</i> - - - 136, 337	<i>Vanda congesta</i> - - - 522
125, 318	<i>Státice arborea</i> - - - 43, 136, 430	<i>Vanilla aromatica</i> - - - 117, 207
<i>Sàlix ægyptiaca</i> - - - 254	<i>sinuata</i> - - - 205	<i>planifolia</i> - - - 207
<i>álba</i> - - - 181	<i>Stenochilus incanus</i> - - - 560	<i>Verbena Arraniana</i> - - - 430
<i>annularis</i> - - - 318	<i>Stènia fascicularis</i> - - - 72	<i>chamædrifolia</i> - - - 57
<i>æretica</i> - - - 254	<i>Styldium fasciculatum</i> - - - 430	<i>grandiflora superba</i> - - - 430
<i>babylónica</i> - - - 61, 66, 254	<i>graminifolium</i> - - - 44	<i>incisa</i> - - - 44, 430
<i>crispa</i> - - - 66	<i>Styrax officinalis</i> - - - 59, 318	<i>latifolia</i> - - - 430
<i>cinèrea</i> - - - 181	<i>Sutherlandia frutescens</i> var.	<i>Melindres</i> - - - 430
<i>gariepina</i> - - - 343	<i>obcordata</i> - - - 454	<i>Nefillii</i> - - - 430
<i>hastata</i> - - - 254	<i>Syringa Josikæ'a</i> - - - 116	<i>officinalis</i> - - - 182
<i>herbæca</i> - - - 254	<i>Symphoria racemosa</i> - - - 260	<i>officinali-venosa</i> - - - 598
<i>hirta</i> - - - 254	<i>Tacsonia pinnatistipula</i> 475, 645	<i>teucroides</i> - - - 37, 75, 430
<i>lanata</i> - - - 622	<i>Tamarindus indica</i> - - - 332	<i>Tweediana</i> - - - 430
<i>Lindleyana</i> - - - 254	<i>Tamarix gállica</i> - - - 610	<i>superba</i> - - - 430
<i>monandra</i> - - - 181	<i>orientalis</i> - - - 610	<i>Veronica agræstis</i> - - - 193
<i>polaris</i> - - - 254, 622	<i>Tanacetum vulgare</i> - - - 493	<i>Anagallis</i> - - - 457
<i>purpurea</i> - - - 181	<i>Tanghonia Manghas</i> - - - 74	<i>decussata</i> - - - 47
<i>reticulata</i> - - - 622	<i>Taxodium distichum</i> - - - 67, 117	<i>diosmæfolia</i> - - - 465
<i>tetrandifolia</i> - - - 254	<i>sinense</i> - - - 575	<i>formosa</i> - - - 465
<i>tetrasperma</i> - - - 254	<i>Taxus baccata</i> - - - 338	<i>maritima</i> - - - 182
<i>viminàlis</i> - - - 181	<i>globosa</i> - - - 130, 242	<i>spùria</i> - - - 182
<i>vittellina</i> - - - 181	<i>Harringtonia</i> - - - 236	<i>Vesicaria gracilis</i> - - - 477
<i>Sàlvia argentea</i> - - - 521	<i>latifolia</i> - - - 343	<i>grandiflora</i> - - - 477
<i>confertiflora</i> - - - 596	<i>montana</i> - - - 187	<i>Viburnum cotonifolium</i> - - - 576
<i>Gràhami</i> - - - 60	<i>Tècoma capensis</i> - - - 343	<i>pyrifolium</i> - - - 318
<i>leucantha</i> - - - 531	<i>jasminoides</i> - - - 206	<i>Tinus</i> - - - 59
<i>Moorcroftiana</i> - - - 598	<i>Telòpea speciosissima</i> - - - 41	<i>Vicia sativa</i> - - - 342
<i>pàtens</i> - - - 135	<i>Teucrium Mårum</i> - - - 67	<i>Victoria regalis</i> - - - 258
<i>Saponaria hybrida</i> - - - 182	<i>orientale</i> - - - 67	<i>Viussæuxia aristata</i> - - - 534
<i>officinalis</i> - - - 182	<i>Thèa Bolèa</i> - - - 575	<i>Viola montensis</i> - - - 338
<i>Sarcochilus olivaceus</i> - - - 247	<i>viridis</i> - - - 234, 471, 575	<i>odorata</i> - - - 193
<i>Sarracènia psittacina</i> - - - 430	<i>Theobroma Cacao</i> - - - 352	<i>palmata</i> - - - 69
<i>purpurea</i> - - - 195	<i>Thrinax parviflora</i> - - - 145	<i>variegata</i> - - - 69
<i>Satyrion candidum</i> - - - 79, 534,	<i>Thùja articulata</i> - - - 694	<i>Virgilia capensis</i> - - - 342
535	<i>occidentalis</i> - - - 67, 260	<i>Viscaria gracilis</i> - - - 477
<i>carneum</i> - - - 534, 535	<i>orientalis</i> - - - 67, 255	<i>grandiflora</i> - - - 477
<i>chrysothachyum</i> - - - 536	<i>Thunbergia Hawtayneana</i> 521	<i>Vitex Agnus castus</i> - - - 99, 318
<i> cucullatum</i> - - - 535	<i>Thymus angustifolius</i> - - - 339	<i>Willemètia africana</i> - - - 342
<i>erectum</i> - - - 399	<i>granatensis</i> - - - 339	<i>Wintera aromatica</i> - - - 693
<i> papillòsum</i> - - - 79, 535	<i>longiflorus</i> - - - 339	<i>Wistaria sinensis</i> 117, 193, 247,
<i>Scaphyglòttis reflexa</i> - - - 246	<i>membranaceus</i> - - - 359	401
<i>stellata</i> - - - 399	<i>serpylloides</i> - - - 339	<i>Xanthoxylum fraxineum</i> 58, 67
<i>Sceptranthus Drummòndi</i> 400	<i>Tilia álba</i> - - - 66	<i>Xeròtes longifolia</i> - - - 82
<i>Schomburgkia marginata</i> 137,	<i>argentea</i> - - - 115	<i>Yucca gloriosa</i> - - - 61, 159
336	<i>Torènia cordifolia</i> - - - 245	<i>Zàmia horrida</i> - - - 192
<i>pétalis sepalisque im-</i>	<i>Torrèya taxifolia</i> - - - 187	<i>integrifolia</i> - - - 192
<i>marginatis</i> - - - 398	<i>Tourètia lappacea</i> - - - 559	<i>Zantedeschia æthiòpica</i> - - - 343
<i>Scòttia dentata</i> - - - 559	<i>Trymalium odoratissimum</i> 581	<i>Zichya tricolor</i> - - - 558
<i>Sedum rivulare</i> - - - 339	<i>Tradescantia iridæscens</i> - 82	<i>Zigadènum glaucus</i> - - - 202
<i>Sempervivum africanum</i> - - - 342	<i>Trichinium alopecuròideum</i> 396	<i>elegans</i> - - - 202
<i>arboresum</i> - - - 342	<i>Trichocèntron iridifolium</i> 79	<i>Zizyphus Joazeiro</i> - - - 392
<i>Senecio odoratus</i> - - - 559	<i>Trichopilia tortilis</i> - - - 581	<i>sativa</i> - - - 113

LIST OF FRUITS.

Apples : —	Peach : —	Pears : —
Select list of - - - 140	Pourprée Hâtive - 151, 152	Nelis d'Hiver - - - 580
Downton Nonpareil - 580	Pears : —	Rose Water - - - 209
Duchess of Oldenburg - 532	Althorp Crassane - 142	Select List of - 138, 139
Pine-apple Russet 151, 152	Aston Town - 141, 209	Shobden Court - - - 580
Scarlet Crofton - - - 152	Belle de Jersey - - - 579	Summer St. Germain - 532
Cherry, Late Duke - - - 532	Bergamotte de Pâques 579	Thompson's - - - 142
Date - - - - - 595	Beurré d'Aremberg - 579	Urbaniste - - - 152
Grapes : —	Beurré Bosc - - 118, 142	Van Mons Léon le Clerc 148,
<i>cult.</i> 405, 516	Beurré de Capiaumont 142	574
Cannon Hall Muscat 452, 480	Beurré Coloma - - 118	Winter Crassane - 142, 580
Chasselas de Fontaine-	Beurré Diel - - - 141	Winter Nelis - - - 142
bleau - - - - - 118	Beurré Magnifique - 579	Pine Apple 277, <i>cult.</i> 404, 516
Eshcollâta supérba - 212	Beurré de Ranz - - 141	Moore Green Seedling 533
Money's West St. Peter's 212	Beurré Spence - - - 152	Trinidad Pitch Lake - 207
Mornain Blanc - - - 118	Bon Chrétien Fondant 141	Plums : —
Muscat of Alexandria - 212	Chaumontel Swan's Egg 574	Diaprée Rouge - 151, 152
Muscat Eshcollâta - 212	Comte de Launy - - 144	Imperial Diadem - 151, 152
New Variety - - - 152	Délices d'Hardenpont 579	Mimms - - - 151, 152
Raisin des Carmes - 212	Duchesse d'Angoulême 574	Nectarine - - - 532
Sweetwater - - - 614	Easter Beurré - - - 141	Preserving - - - 602
White Raisin - - - 199	English Caillot Rosat - 532	Reine Claude Violette 152,
Melon - - - - - 175, 412	Fortunée Belge - - - 579	583, 580
Mûsa Cavendishii - - - 196	Gansell's Bergamot - 209	Royal Hâtive 148, 152, 533
Nectarine Elruge - - - 515	Glout Morceau - - - 142	Washington - - - 532
Olive - - - - - 595	Hacon's Incomparable 141	Raspberries - - - 293
Peach, <i>cult.</i> - - - 409, 600	Knight - - - - - 580	Strawberries, <i>cult.</i> - - - 581
Acton Scott - - - 532	Louise Bonne - - - 580	Hautbois, <i>cult.</i> 472, 573, 629
Grosse Mignonne - 151, 152	Louise Bonne of Jersey 142	Myatt's Pine - - - 211
Noblesse - - - - - 515	Marie Louise - - - 574	

LIST OF CULINARY VEGETABLES.

Artichokes - - - - 117	Cucumber - - - - 412	Peas : —
Asparagus - - 117, <i>cult.</i> 279	Endive - - - - - 162	Dwarf Fan - - - - 146
Cabbage Tribe : —	Leek, Gros Court - - 303	Frame - - - - - 146
Chinese - - - - - 162	Lettuce - - - - - 566	Milford - - - - - 472
Chou Billandeau - 568	Mushroom - 117, <i>cult.</i> 333	Potatoes : —
Vanack - - - - - 616	Mustard, Chinese - - 162	Sweet or Spanish - 162
Cauliflower - - - 566	Peas : —	Rhubarb - - - - - 41
Carrot, <i>cult.</i> - - - 604	Bishop's Early Dwarf - 146	Spinach, Flanders - - 146
Celery, new var. - - 96	Charlton - - - - - 146	Truffle, <i>cult.</i> - - - 419

LIST OF AGRICULTURAL PLANTS.

Avèna sativa : —	Mangold Wurzel - - - 163	Wheat : —
White and Black var. - 163	Medicâgo arbdrea - - 572	Chevalier - - - - 24
Clover, Gigantic - - - 572	Milium effusum - - - 471	St. Helena - - - - 24
E'lymus geniculâtus - 471	Trifolium hÿbridum - 163	White Cluster - - - 24
Lucerne - - - - - 163	Wheat - - - - - 281	Whittington - - - 24

LIST

OF HORTICULTURAL, BOTANICAL, AND FLORICULTURAL SOCIETIES.

Aberdeenshire Hort. Assoc. 686	Berks Royal Hort. - - - 675	Calne Hort. - - - - 683
Aberdeenshire Hort. - 686	Biggleswade Hort. - - 674	Cambridge Amateur-Florists' 675
Aitkin's Hort. - - - 691	Birmingham Bot. and Hort. 682	Cambridgeshire Hort. - 675
Altringham Flor. and Hort. 675	Birmingham Grand Dahlia	Carlisle Hort. - - - 675
Ashbourn Flor. and Hort. - 676	Show - - - - - 682	Chelmsford Flor. and Hort. 677
Aylesbury Flor. and Hort. 675	Bolton Flor. and Hort. - 680	Chichester Hort. - - - 682
Ayrshire Hort. and Agric.	Bourn Grand Dahlia Show 675	Chillwell and Beeston Flor.
Assoc. - - - - - 686	Bristol and Clifton Amateur	and Hort. - - - - - 681
Baldock Hort. - - - - 678	Dahlia - - - - - 682	Chillwell and Beeston Flo-
Barnet Hort. - - - - 677	Bristol Hort. - - - - 682	rists' Soc. - - - - - 681
Bath Royal Hort. and Bot. 682	Buckingham Domestic Hort. 675	Chippenham Dahlia Show - 682
Bathwick Pink Feast - 682	Burton-on-Trent Hort. - 682	Chorley Hort. - - - 680
Battle and Hastings Hort. - 682	Caledonian Hort. - - - 685	Cirencester Hort. - - - 677
Bedford Open Dahlia Show 674	Caledonian Gardeners - 686	Clackmannanshire Hort., - 687

Cornwall Royal Hort.	- 675	Kent and Canterbury Flor.	- 678	Sheffield Bazaar Florists'	- 683
C Coventry and Warwickshire	- 682	Kentish Town and North	- 680	Sheffield Hort.	- 683
C Cranbrook and Weald of	- 680	London Flor.	- 680	Sherborne and Yeovil Hort.	682
C Kent Hort.	- 689	Kilkenny Hort.	- 691	Shrewsbury Union Florists'	- 682
C Cupar Hort.	- 681	Kilmadock and Kincardine	- 690	Soc.	- 677
C Deddington Annual Show	- 680	Cottage Garden	- 687	South Essex Hort. and Flor.	- 680
C Denton Tulip Show	- 676	Kilnarnock Hort. Exhib.	- 689	South London Hort.	- 682
C Derby Tulip Show	- 676	Lancaster Hort.	- 683	Stafford Flor. and Hort.	- 688
C Devon and Cornwall Royal	- 676	Leeds Hort.	- 680	St. Andrews Hort. and Flor.	688
C Hort.	- 676	Leicester Flor. and Hort.	- 682	Stayley Bridge Tulip Exhib.	675
C Devon and Exeter Bot. and	- 683	Lichfield Flor. and Hort.	- 682	Stirling Hort.	- 678
C Hort.	- 683	Liversedge Hort. and Flor.	- 680	St. Neots Hort.	- 677
C Doncaster Hort.	- 682	Loughborough Hort.	- 683	Stockbridge Pink Show	- 682
C Dorking Hort.	- 677	Maidstone Hort.	- 680	Stowmarket Hort.	- 674
C Dorset Hort.	- 687	Malton Hort.	- 683	Sunbury Royal Hort.	- 677
C Dumfriesshire and Galloway	- 681	Manchester Bot. and Hort.	- 680	Sunderland Flor. and Hort.	- 682
C Hort.	- 681	Manchester Zoolog. Gardens	- 680	Tamworth Hort.	- 682
C East Dereham Hort.	- 681	Flor.	- 681	Tavistock and West Devon	- 676
C English Agr.	- 681	Market Drayton Hort.	- 681	Agric. and Hort.	- 680
C Everton and Kirkdale Flor.	- 680	Metropolitan Soc. of Florists	- 681	Thurleston and Narborough	- 680
C and Hort.	- 681	Mid-Lothian Hort.	- 681	Flor. and Hort.	- 680
C Falkirk Hort.	- 674	Newport Hort. and Flor.	- 681	Tunbridge Wells Hort.	- 687
C Farrington Hort.	- 680	Northampton New Hort.	- 677	Upper Annadale Hort.	- 682
C Faversham Hort. and Flor.	- 681	North Devon Hort.	- 691	Uttoxeter Hort. and Flor.	- 680
C Felton Florists' Soc.	- 690	Northern Hort. Soc. (Belfast)	- 677	Uxbridge Hort.	- 682
C Fifeshire Hort. and Flor.	- 690	North Herts and South Beds	- 677	Wallington Grand Dahlia	- 682
C Forbes and Nairn Hort.	- 690	Hort.	- 678	Show	- 682
C Glasgow Hort.	- 690	North Herts Hort.	- 683	Wallington Pink Show	- 680
C Glasgow Practical Florists'	- 687	North Riding Hort. and	- 683	Warrington Dahlia Show	- 682
C Club	- 687	Flor.	- 681	Warwickshire Flor. and	- 691
C Glenkens Soc.	- 680	Northumberland Bot. and	- 680	Hort.	- 682
C Gloucestershire Zoolog. Bot.	- 684	Hort.	- 677	Waterford Hort.	- 682
C and Hort.	- 684	Norwich Hort.	- 682	Weston Geranium Show	- 683
C Grantham Flor. and Hort.	- 680	Oldham Dahlia and Hort.	- 682	West Riding Hort.	- 683
C Guernsey Hort.	- 680	Old Down Pink Feast	- 681	Whitby Hort.	- 675
C Hampstead Florists' Soc.	- 680	Oxfordshire Hort.	- 690	Whitehaven Hort.	- 682
C Hampton Tulip Show	- 680	Paisley Flor. and Hort.	- 675	Wilts Hort.	- 677
C Hants Hort.	- 684	Penrith Flor. and Hort.	- 689	Winchester Auricula Show	- 677
C Hensworth Hort. Exhib.	- 681	Pitlessie Hort.	- 677	Winchester Hort. Assoc.	- 677
C Henley Hort.	- 680	Pittville Hort. Assoc.	- 681	Winchester Pink Show	- 674
C Herts Hort.	- 680	Practical Flor. and Hort.	- 675	Windsor and Eton Royal	- 680
C Highgate Hort.	- 686	Soc. of Ireland	- 683	Hort.	- 675
C Highland and Agric. Soc. of	- 677	Reading Hort.	- 683	Wingham Hort. and Flor.	- 675
C Scotland	- 680	Retford and Bawtry Hort.	- 683	Wisbeach Hort.	- 682
C Hitchin Hort. Exhib.	- 683	Ripon Florists' Soc.	- 683	Wolverhampton Dahlia	- 682
C Hooley Hill Soc. of Florists	- 678	Rotherham Soc. of Florists	- 683	Show	- 682
C Hull Flor. and Hort.	- 682	and Amateurs	- 690	Wolverhampton Flor. Soc.	- 683
C Huntingdonshire Hort.	- 682	Royal Hort. Soc. of Perth-	- 682	Worcestershire Hort.	- 675
C Hurstperpoint Hort.	- 682	shire	- 682	Worlington Flor. and Hort.	- 684
C Ipswich Floral Meeting	- 684	Salisbury Plain Dahlia Ex-	- 682	Wrexham Hort.	- 684
C Ipswich Hort.	- 684	hibition	- 682	York Amateur-Florists' Soc.	- 683
C Jersey Agric. and Hort.	- 683	Salisbury Royal Dahlia Show	- 681	York Hort.	- 682
C Keighly Dahlia Show	- 683	Salop Hort.	- 681	Yorkshire Grand Hort. Fête	684

## LIST OF GARDENS AND COUNTRY SEATS.

Abbey Manor House Gar-	- 176	Glasgow	- 71. 82. 187. 245.	Carlew, Cornwall	- 630
den	- 76		268. 464. 598	Carlton Hall Gardens	- 96
A Aigburgh	- 457	Glasnevin	- 75. 272	Castle Stewart	- 628
A Aldershaw, Lichfield	- 25	Leeds	- 305. 306. 316	Capheaton, Northumberland	- 119. 299. 571
A Annat Cottage	- 471	Liverpool	- 81	Cawdor Castle	- 628
A Annat Gardens	- 40	Lyons	- 169	Cemetery, Birmingham	- 456
A Armagh Palace Gardens	- 510	Manchester	- 42	Sheffield	- 455
A Arno's Grove	- 616	Montpelier	- 271	Chatsworth, Duke of Devon-	- 300. 395. 450. 644. 661
A Ashridge	- 395	Munich	- 61. 153	Cheshunt Cottage, William	- 633
A Bagshot Park	- 531	Oxford	- 57. 542. 597	Harrison, Esq.	- 26. 412
A Bicton Garden	- 124	Padua	- 316	Cossey Hall, Norfolk	- 429
A Botanic Garden, Avignon	- 41	Regent's Park	- 322	Cottage of H. B. Ker, Esq.,	- 405
A Belfast	- 69. 128	Rio	- 76	Park Road, Regent's Park	- 480
A Berlin	- 69. 70. 135.	Sheffield	- 453. 572	Cranston Hill Gardens	- 480
A Birmingham	- 248. 456. 478. 537. 597. 626	Upsal	- 297	Dagnam Park, Essex	- 626
A Bury St. Edmunds	- 298. 569. 622	Bridehead House, Dorset	- 119	Denham Hall, Suffolk	- 457
A Calcutta	- 71. 559	Bridge Hill, Belper	- 448	Drayton Manor	- 127. 270
A Cambridge	- 198	Bretby Hall	- 449	Dropmore	- 422
A Dublin	- 69. 71. 123. 260.	Brockley Hall, Somersetshire	- 570	Dunkeld Gardens	- 360
A Edinburgh	- 396. 464. 520	Bromley Hill, Kent	- 616	Eastwell Park, Kent	- 667
A Ghent	- 188	Camden House	- 122	Elvaston Castle	- 458. 655. 667
		Cantray, the Seat of General	- 628		
		Sir John Rose	- 628		

Establishment, Chapelle's	Linton Place, Kent	- 360	Nurseries:—	
Agricultural and Horticultural	Loseley Park, Surrey	- 14	Milford	- 70. 96. 472. 559
Fitzwalters', near Shinfield, Essex	Lowther Castle Park	- 195	New Garden, Whitty	- 123
Folkstone, T. Holman, Esq.	Manly Hall	- 457	Sawbridgeworth	- 107. 235
Formark	Minchenden House	- 511	St. Foy	- 118
Gardens:—	Mostyn Hall, Holywell	- 204	St. Just	- 117
Birmingham Horticultural	Mount Grove, Hampstead	- 1	Tooting	- 70
Edinburgh Experimental	Newton le Willows, — Forest, Esq.	- 210	Vaise	- 113
Kent Zoological and Botanical	Ness Castle Gardens, near Inverness	- 248	Ville d'Avray	- 121
London Horticultural	Norbiton Hall, R. H. Jenkinson, Esq.	- 426	Villeurbanne	- 115
113. 123. 138. 145. 202. 348. 395. 476	Nurseries:—		Oakhill	- 515
Market, of M. Chaine	Armand's, M.	- 114	Osmaston Hall	- 450
Mr. Bonam	Athens	- 99	Powis Park	- 510
Desio	Birmingham	- 457	Redleaf Gardens	- 353
M. Gariot	Bollwyller	- 97	Repton	- 449
M. Guillot	Boston	- 38	Saltmarsh Hall Gardens	- 96
Rev. John Monson	Botanic, at New Burgh, New York	- 38	Saltwood, Hythe, Archdeacon Croft	- 221
Miss Peirse	Bouchar'd's, M.	- 112	Southgate Lodge	- 512
Jedediah Strutt, Esq.	Bourcier's, M.	- 112	South Lodge, — Webber, Esq.	513
Joseph Strutt, Esq.	Clapton	- 147	Spencer Wood, near Quebec	195
419	Derby	- 449	Spoiforth, Hon. Rev. Wm. Herbert	- 82
Goodwood Park	E'cully	- 114	Springfield, George Barker, Esq.	- 82
Grounds of Mme. E'vesque	Edgbaston	- 36	St. Clairtown Gardens	- 50
Grove Parsonage, Wantage	Epsom	- 73. 303	St. Helen's, Derby	- 448
Holm, Inverness	Exotic, King's Road, see Knight's.		Stoke Edith Park	- 57
Hyde Park	Exotic, St. Peter's, Canterbury	- 320	Swarkstone Lowes	- 450
Hylands, Chelmsford	Glazenwood	- 92. 233	Syon Gardens	- 588
Keddleston Hall	Guillotière	- 117	Teddington Grove	- 424
Kew Gardens, 125. 347. 616. 595	Hammersmith	- 151	Theobald's Park	- 514
Kensington Gardens - 131. 158	Handsworth - 231. 597. 598		Thorp Perrow, Mark Milbank, Esq.	- 211
Kenwood, Hampstead - 2	Hereford	- 547	Thoresby Park Gardens	- 517
Kilravock, Inverness - 628	Hope, Yorkshire	- 530	Tredegar Park, Monmouthshire	- 571
Kingsbury Gardens - 29. 56. 96. 161. 196. 244. 347. 396. 400. 549. 552.	Knight's Exotic, King's Road - 240. 245. 274		Wentworth Gardens	- 50
Kinnaird Castle - 599	Loddiges's, Messrs., Hackney - 323. 413		Wimbledon, Mrs. Marryatt	429
Knapsley Park - 91. 195. 477	Makoy's, M., Liège - 296		Whitton Park, George Gosling, Esq.	- 424
Knyppersley, — Bateman, Esq. 79. 187	Martin-Burdin's, M., Mile End - 145		Woburn Abbey - 71. 127. 137. 147. 243. 263.	
			Worton Lodge, George Glenry, Esq.	- 530

## LIST OF BOOKS REVIEWED OR NOTICED.

Anon. Annales des Sciences, 168.	Botanical Periodicals, 90.
Anon. Companion to the Almanack for 1839, 282.	Châteauneuf's Architectura Domestica, 703.
Anon. Journal of the English Agricultural Society, 345.	Claxton's Hints to Mechanics, 179.
Anon. Le Courier Agricole et Horticole, &c., 184.	Cooper's Catalogue of the British Natural Orders and Genera, 174.
Anon. Proceedings of the Linnean Society of London, 176.	Curtis's Botanical Magazine, 68. 134. 242. 394. 463. 520. 557. 596.
Anon. Proceedings of the Royal Asiatic Society, 177.	De Candolle's Vegetable Organography, 174. 468. 702.
Anon. Report of the Society for obtaining free Admission to Societies and Public Edifices containing Works of Art, 417.	Dillwyn on the Effects of the Winter of 1837 and 1838, in Glamorganshire, 561.
Anon. The Bouquet, or Lady's Flower-Garden, 175.	Dillwyn's Review of the Hortus Malabaricus, 276.
Anon. The British Almanack for 1839, 282.	Don's Edition of Sweet's Hortus Britannicus, 701.
Anon. The Civil Engineer and Architect's Journal, 703.	Duncan's Treatise on the Melon, 175.
Anon. The Engineer and Surveyor's Magazine, 703.	Edinburgh Botanical Society, Second Annual Report, 257.
Anon. The Guide to Service, 703.	Endlicher's Theorie, &c., 287.
Anon. The Mirror of Literature, &c., 180. 471.	Fennel's Child's Book of Zoology, 704.
Anon. The Year-Book of Facts, 179.	Francis's Little English Flora, 87.
Anon. Transactions of the Society of Arts, 281.	Gardening, Agriculture, Botany, &c., Catalogue of Works on, 701.
Audibert's Catalogue des Arbres, Arbustes, et Plantes, &c., 180.	Glendinning's Hints on the Culture of the Pine Apple, 277.
Bedford's, Duke of, Pinetum Woburnense, 263.	Harvey's Genera of South African Plants, 340.
Berlèse's Iconographie du Genre Camellia, 467.	Howard's Colour as a Means of Art, 470.
Birmingham Botanic Garden Catalogue, 413.	Howard's Science of Drawing, 469.
Boissier's Elenchus Plantarum, 337.	Howard's Sketcher's Manual, 470.
Booth's Stranger's Guide to London, 471. 562.	Ingpen's Instructions for collecting and preserving British Insects, 468.
	Jersey Agricultural and Horticultural Society, Fifth Annual Report, 344.

- Knowles and Westcott's Floral Cabinet, 69. 135. 243. 394. 463. 520. 558. 596.  
 Kollar's Die Vier Hauptfeinde der Obstgärten, &c., 171.  
 Kollar's Insects Injurious to Gardeners, 288.  
 Legrandais's Catalogue des Plantes, 180.  
 Lindley's Ladies' Botany abridged, 561.  
 Lindley's School Botany, 275.  
 Lindley's Botanical Register, 68. 134. 242. 394. 463. 520. 558. 596.  
 Lindley's Sertum Orchidaceum, 135. 336.  
 Loddiges's Catalogue of Orchideæ, 177.  
 Loudon's Edition of Repton's Landscape-Gardening, &c., 418. 466.  
 Loudon's Hortus Britannicus, Second Additional Supplement to, 416.  
 Loudon's, Mrs., Ladies' Flower-Garden, 88.  
 Main's Forest Pruner, 467.  
 Main's Young Farmer's Manual, 523.  
 Marcet's Vegetable Physiology, 276.  
 Mason's Description of Goodwood, 523.  
 Maund's Botanist, 69. 135. 243. 394. 558. 596.  
 Maund's Botanic Garden, 68. 135. 242. 558. 596.  
 Mawe and Abercrombie's Every Man his own Gardener, 276.  
 Millet d'Aubenton's Oseraie, &c., 181.  
 M'Intosh's Cultivation of Green-house, Hot-house, and Stove Plants, 25.  
 Moseley's Treatise on Mechanics, 282.  
 Niven's Method of Cultivating Asparagus, 279.  
 Paxton's Magazine of Botany, 69. 135. 243. 394. 463. 520. 558. 596.  
 Payne's Apiarian Guide, 178.  
 Pfeiffer and Otto's Descriptions of Cacti, &c., 522.  
 Pile's Floriculturist, 276.  
 Recueil d'Agriculture d'Arvranches, 182.  
 Rogers's Vegetable-Cultivator, 345.  
 Royle's Natural History of the Himalayan Mountains, 253.  
 Seringe on Plants, 181.  
 Seringe's Essai des Formules Botaniques, 182.  
 Sigmond's Treatise on Tea, 471.  
 Sinclair's Hortus Gramineus Woburnensis, 702.  
 Smith's Suggestions on National Education, 417.  
 Smith's Treatise on Cucumbers, Melons, &c., 175.  
 Sweet's Botanical Cultivator, 701.  
 Taylor's Bee-keeper's Manual, 286.  
 Timb's Literary World, 703.  
 Toulon, Plantes des Environs de, 183.  
 Ure's Dictionary of Arts, &c., 34. 179. 282.  
 Vilmorin's Bon Jardinier, 162.  
 Waterton's Essays on Natural History, 417. 419. 468.  
 Westwood's Entomologist's Text-Book, 30.  
 Westwood's Introduction to the Classification of Insects, 32.  
 Wight's Icones Plantarum Indiæ Orientalis, 288.  
 Wight's Illustrations of Indian Botany, 288.  
 Wilkinson's Gardening and Agriculture of the Ancient Egyptians, 611.  
 Willmott's Amateur-Florist's Assistant, 174.

## LIST OF CONTRIBUTORS.

- Aberdeen, Earl of, 697. A Constant Reader, 616.  
 Allen, Henry, 96. A. M., 479. Amateur, 42.  
 Atkinson, Henry, 195. A young Subscriber, 149. 431.  
 B., 150. 299. 526. Baumann, Eugene Achille, 98.  
 Bawel, H., 572. Baxter, W. H., 57. 94. 542.  
 Beaton, D., 56. 96. 161. 187. 188. 328. 347. 401. 422. 432. 472. 549. 552. Bishop, T., 618. Booth, W. B., 630. Brown, W., 614.  
 Cameron, D., 537. Campbell, Alexander, 42. C. G. M., 48. Christy, W., jun., 39. 190. 536. Clericus, 303. Colley, T., 530. Conductor, 1. 36. 38. 40. 49. 92. 94. 122. 123. 124. 125. 126. 127. 131. 144. 145. 147. 148. 152. 184. 185. 186. 188. 189. 195. 196. 197. 202. 213. 291. 292. 295. 301. 302. 303. 304. 322. 347. 348. 353. 421. 422. 434. 472. 473. 477. 478. 509. 517. 525. 526. 527. 529. 530. 563. 564. 565. 567. 569. 570. 572. 588. 614. 615. 619. 621. 624. 626. 704. Cook, S. E., 201. 692. Cotswold, 373. Curtis, Samuel, 233.  
 Dall, J., 584. D. B. K., 121. D. C., 39. 626. D. M., 124. Downing, A. J., 39. Dunbar, Wm., 151.  
 Ellis, D., 481.  
 Falconer, R. W., 379. Ferguson, Daniel, 41. F. F., 472. Forsyth, A., 333. 404. 539. 600. 604. Frewin, James, 195.  
 Gardiner, R., 599. Godsall, W., 547. Gorrie, A., 24. 471. G. R., 194. Graves, N. H., 152. Grigor, John, 248.  
 H., 617. Harbison, James, 119. Hertz, W., 142. Hutchinson, James, 405.  
 Jacquin, 236. 630. J. B., 526. J. B. W., 152. 209. J. D., 187. J. H. S., 91. J. H. S. P., 571. J. L., 153. 389. 602. J. M., 302. 472. 573. J. R., 473. J. T. M., 198. J. W. L., 290.  
 Kellerman, A., 83.  
 Lawson, C., 109. Leyson, E. A., 571. Lhotsky, Dr. John, 249. 329. 595. Long, H. L., 9.  
 M., 40. 629. M. C., 56. M. D. B., 630. Main, J., 52. Major, J., 92. 305. Manetti, G., 193. 316. 421. Manvers, Earl of, 517. Marnock, R., 573. Masters, W., 320. Masters, W. A., 402. 469. M'Nab, Robert, 294. Monro, J., 585.  
 N. M. T., 21. 22. 219. N. W. G., 526.  
 Ogle, H. C., 96. Ord, G., 327.  
 P. N., 199. 431. Pope, Alexander, 231.  
 Rivers, J., 23. Rivers, T., jun., 107. 141. 235. 626. R. L., 296. R. S. M., 40. R. T., 36. 148. 152. 620. 630.  
 Saul, M., 626. Scott, John, 472. S. E. C., 340. Seitz, M. L. C., 61. Serret, Baron de, 325. Silliman, R., jun., 529. Simpson, Thomas, 294. Somerville, W., 477. S. T., 187. 222. 300. Stevens, C., 224. Strangways, Wm. Fox, 119. 122. Stuart Menteith, G. G., 618. Swainson, W., 94. Swinburne, John C., 120. 299. 571.  
 Taylor, H., 525. Taylor, Samuel, 93. 545. T. B., 92. T. C., 629. Thompson, Robert, 138. Tims, J., 616. T. S. W., 303. Turner, H., 530.  
 Vilmorin, 111.  
 Wagner, F. E., 296. Wailes, G., 300. W. A. M., 469. W. C., 37. Webb, P. B., 589. Westcott, F., 478. Westwood, J. O., 103. W. G., 37. 201. W. I., 57. Wighton, J., 25. 412. 605. Williams, J. B., 621. Wilshere, W., 236. W. S., 36.  
 X., 132.

THE  
GARDENER'S MAGAZINE,  
JANUARY, 1839.

---

ORIGINAL COMMUNICATIONS.

ART. I. *Descriptive Notices of select Suburban Residences, with Remarks on each; intended to illustrate the Principles and Practice of Landscape-Gardening.* By the CONDUCTOR.

No. 10.\* MOUNT GROVE, HAMPSTEAD.

HAMPSTEAD and Highgate have been noted for their suburban villas, ever since the time of Gerard and Parkinson. These villas appear to have been then, as now, principally occupied by London merchants; many of whom had rich gardens, containing foreign plants introduced through their connexion with other countries. It was in the garden of Master James Cole at Highgate, Parkinson's particular friend, that the common laurel was first planted: and there, we are informed, it flowered and ripened fruit; being protected through the winter by a blanket thrown over it in the most severe weather. Hampstead and Highgate are not only well calculated for villas from their elevated surface, but also from that surface being varied by numerous and strongly marked undulations; so that all these villas have not only views of considerable extent in one direction, but many of them have what may be called home views across the undulations. The Hampstead and Highgate villas,

\* No. 1. we consider to be Dr. Neill's Garden, Canon Mills Cottage, Edinburgh, Vol. XII. p. 333.; No. 2. the Garden of H. Marshal, Esq., in the town of Godalming, Vol. XII. p. 474.; No. 3. Chesterholme Parsonage, the residence of the Rev. Anthony Hadley, Vol. XIII. p. 163.; No. 4. Hendon Rectory, the residence of the Rev. Theodore Williams, Vol. XIV. p. 220.; No. 5. Mrs. Lawrence's Villa at Drayton Green, Vol. XIV. p. 305.; No. 6. Hoole House, near Chester, the residence of Lady Broughton, Vol. XIV. p. 353.; No. 7. Quinta de la Valle, the residence of Dr. Renton in Madeira, Vol. XIV. p. 449.; No. 8. Bedford Lodge, Camden Hill, the Duke of Bedford, Vol. XIV. p. 401.; No. 9. The Garden of Mr. Abel Ingpen, A.L.S., Upper Manor Street, Chelsea, Vol. XIV. p. 456. In the course of the current volume, we intend to give plans and views of Kenwood near Hampstead, Wimbledon House, Redleaf, and Fortis Green (W. A. Nesfield), the engravings of all which are already completed; and of Mr. Harrison's Villa at Cheshunt, the Abbé Gosier's Villa at Rouen, a villa at Berlin, a villa at Frankfort, and one at Desio near Milan, the drawings of which have been made or received. Besides these, we contemplate giving several British villas, to the owners of which we have only just applied for permission to make the necessary plans and views.—*Cond.*

of late years, have attracted much less attention than they deserve, chiefly from the circumstance of the trees and shrubs in them being almost all fully grown; and, consequently, not admitting of the introduction of novelties in the shape of foreign shrubs and flowers, which form the grand attraction in the gardens of modern villas. It is well known to gardeners, that, in all small places abounding with full-grown trees, it is impossible to cultivate shrubs or herbaceous flowers among them with success. The only means of doing so is by having an open airy space, so large as neither to be darkened, nor too much sheltered, by the trunks and branches of the surrounding trees, nor exhausted by their roots. Many of the Hampstead villas hardly admit of having a space of this kind; and, therefore, few of them are very remarkable for their roses or herbaceous flowers.

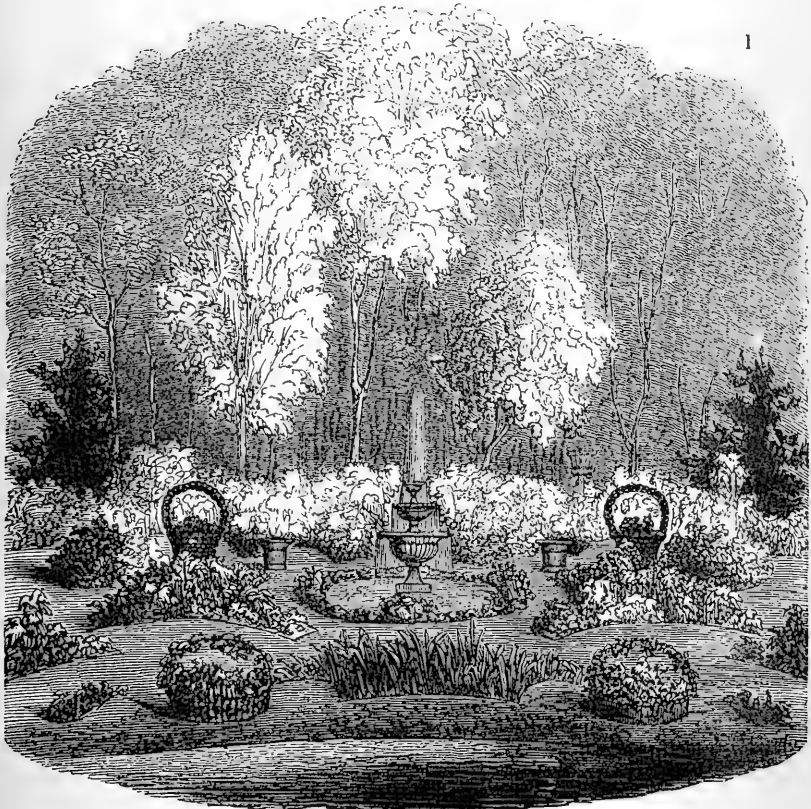
It must be evident, that the grounds of what may be called full-grown villas, of this kind, require to be managed in a different manner, either from large villas where there is abundance of room, or from small villas which have been comparatively recently planted. In the recent villa, and in the villa with abundance of room, the smallest flowering shrubs, such as roses, spiræas, honeysuckles, azaleas, &c., may be cultivated in the shrubberies; but, in the full-grown villa, it is in vain to attempt anything of this kind, except, as we have just remarked, in open airy parts of them. In the progressive culture and management of such villas, therefore, all shrubs and trees, as they become naked below, overshadowed by others, or unsightly in form from any cause whatever, ought to be removed; and the whole attention, as far as respects the old plants of the place, directed to the production and preservation of fine specimens; and these should stand at such a distance, as to admit, beneath them, either of the keeping up of a smooth green turf, or of an undergrowth of evergreens, such as the holly, box, laurel, rhododendron, &c.

We have introduced these remarks, because we have observed in some of the villas about Hampstead, and more especially, some years ago, in that of the Earl of Mansfield at Kenwood, attempts to grow roses, hydrangeas, and other half-hardy shrubs and herbaceous flowers, in patches along the walks, under the shade of high trees or of full-grown shrubs. Even if the success of this mode of culture were complete, it would, in our opinion, be in bad taste; because full-grown trees verging on decay, and masses of flowers, can never be made to harmonise in the same foreground: but, when we consider that flowers introduced in such situations never thrive, and have always a sickly tawdry appearance, it is not too much to say that the effect is disgusting. In the villa which we are now about to notice, all errors of this kind have been carefully avoided, by introducing flowers and flowering shrubs only in open airy



situations, where they are found to thrive nearly as well as they would in a newly planted villa.

*Mount Grove, Hampstead, the Seat of T. N. Longman, Esq.,* (figs. 1. to 5.) is situated at one end of Hampstead; the house forming the last of a row, but the grounds extending considerably, so as, in addition to the lawn and gardens, to include several acres of grass field. The principal natural feature in the grounds is a bold swell, in the direction of east and west, from which it is to be presumed that the place takes its name; and



*Flower-Garden at Mount Grove.*

the chief exterior features are extensive prospects, showing London in front, Greenwich and the river Thames on the east, and Kew and other scenery in Surrey on the west. Mount Grove appears to have been the residence of a lover of gardening upwards of a century ago; for it contains two remarkably fine cedars, and one of the largest tulip trees in the neighbourhood of London. It also contains some remarkably fine specimens of

the Oriental plane, apparently coeval with the tulip tree and the cedars. By the present occupier the place has been very greatly improved; and it has, for many years past, been kept in the very highest order. The principal artificial features within the grounds are: the mount avenue (A in *fig. 2.*), which terminates in a rustic summer-house of a handsome design and very neatly executed, and from which extensive prospects to the west and south are obtained; the flower-garden (B), of which *fig. 1.* is a general view; the view from the house, looking towards the mount, which is shown in *fig. 4.*; and the view of the house, as connected with the cedars, and as seen from the road to the stables, which is shown in *fig. 5.*

The following are the details of the plan (*fig. 2.*): —

*House.*

- |                 |                     |               |             |
|-----------------|---------------------|---------------|-------------|
| a, Drawingroom. | b, Entrance-hall.   | c, Ante-room. | d, Library. |
| e, Dining-room. | f, Butler's pantry. | g, Staircase. | h, Passage. |

*House and Stable Offices, &c.*

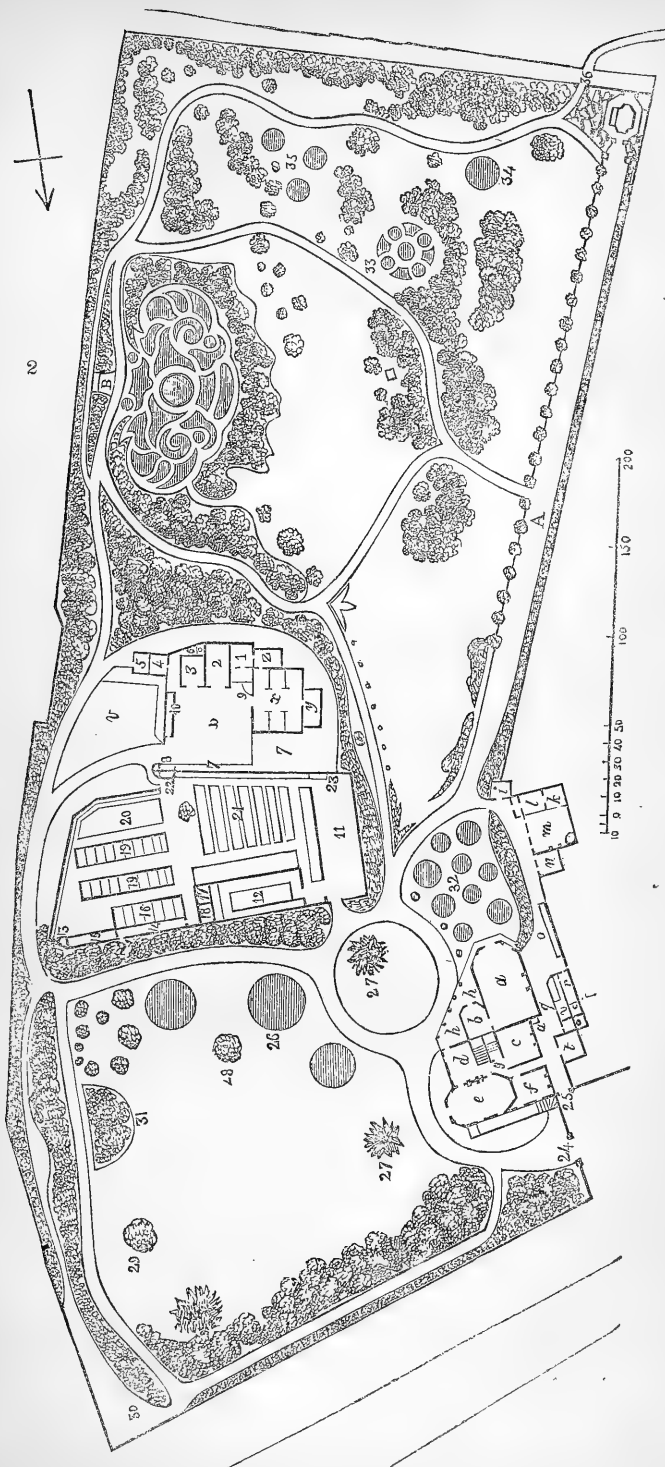
- |                                       |                                |                  |                    |
|---------------------------------------|--------------------------------|------------------|--------------------|
| i, Dairy.                             | k, Coal-house for the laundry. | l, Potato-house. | m, Laundry.        |
| n, Laundress's bed-room.              | o, Bin for wood.               |                  | p p, Privies.      |
| q, Dust-bin.                          | r, Pump.                       | s, Knife-house.  | t, Footman's room. |
| u, Machine-room for the organ.        | v, Drying-ground.              | w, Stable-yard.  |                    |
| x, Stable.                            | y, Hay-loft.                   | z, Harness-room. |                    |
| 1, Groom's room.                      | 2, 3, Carriage-houses.         |                  |                    |
| 4, Coal-house, &c., for the coachman. | 5, Tool-house.                 | 6, Privy.        |                    |
| 7, Border for fruit trees.            | 8, Cistern.                    | 9, Dung-pit.     | 10, Potting-shed.  |

*Frame-Ground.*

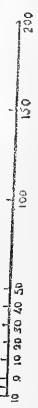
- |   |                  |               |                          |
|---|------------------|---------------|--------------------------|
| 11, Green-house.                            | 12, Vinery.      | 13, Furnace.  | 14, 15, Peach-houses.    |
| 16, Pinery.                                 | 17, Furnace.     | 18, Coal-bin. | 19, Succession pine-pit. |
| 20, Place for green-house plants in summer. | 21, Flower-beds. |               |                          |
| 22, 23, Cisterns.                           |                  |               |                          |

*Pleasure-Grounds.*

- 24, Main entrance. 25, Servants' entrance, both for the house and gardens.
- 26, Three circular masses; one of hardy heaths, another of hardy azaleas, and the third of China roses, varied by substituting other low flowering shrubs every three or four years.
- 27 27, Large cedars of Lebanon, one of which is 65 ft. high. (See *Arb. Brit.*, vol. iv. p. 2426.)
- 28, Large tulip tree. This tree, in 1834, had been planted 80 years. It was then 70 ft. high, with a head 49 ft. in diameter, and the diameter of the trunk 3 ft. 10 in. There is only one tulip tree higher than this in the neighbourhood of London, which is at Syon, and is 76 ft. high. (See *Arb. Brit.*, vol. i. p. 289.)
- 29, Oriental plane; probably the finest specimen in the neighbourhood of London. In 1834, when measured for the *Arb. Brit.*, it was 80 years old, 77 ft. high, the diameter of the head 90 ft., and of the trunk 4 ft. 4 in. (See *Arb. Brit.*, vol. iv. p. 2042.)
- 30, Place for garden rubbish. 31, Mass of rhododendrons.
- 32, Groups of peat-earth low shrubs, fuchsias, pelargoniums, &c.
- 33, Rosarium. 34, China roses.
- 35, Circular beds of hydrangea, heliotrope, China roses, &c.
- 36, Private door to the back lane, opposite to which, on the other side of the lane, is another door, opening into a private walk to the farmyard, grass field, and kitchen-garden.

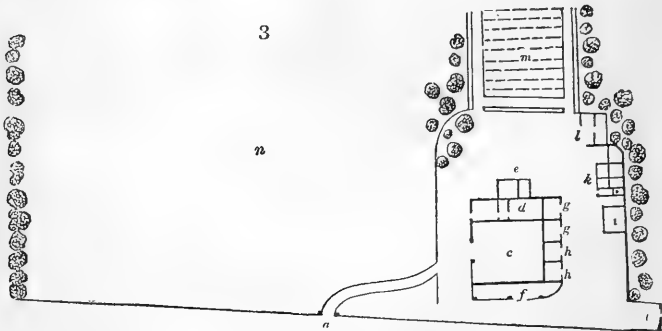


2



*Fig. 3.* is the ground plan of the farmyard, and part of the kitchen-garden and grass fields, separated from the pleasure-grounds by a narrow public lane. The details of this plan are as follows:—

- |  |   |
|--|---|
| <i>a</i> , Private entrance to the farmyard. | <i>b</i> , Cart entrance to the farmyard.     |
| <i>c</i> , Barn.                             | <i>d</i> , Gardener's house.                  |
| <i>f</i> , Open shed.                        | <i>g g</i> , Cart-horse stable and cow-house. |
| <i>h h</i> , Cart-shed and tool-house.       | <i>i</i> , Dung-pit.                          |
| <i>l</i> , Poultry-house.                    | <i>k</i> , Pigsties and privy.                |
| <i>n</i> , Part of the grass field.          | <i>m</i> , Part of the kitchen-garden.        |



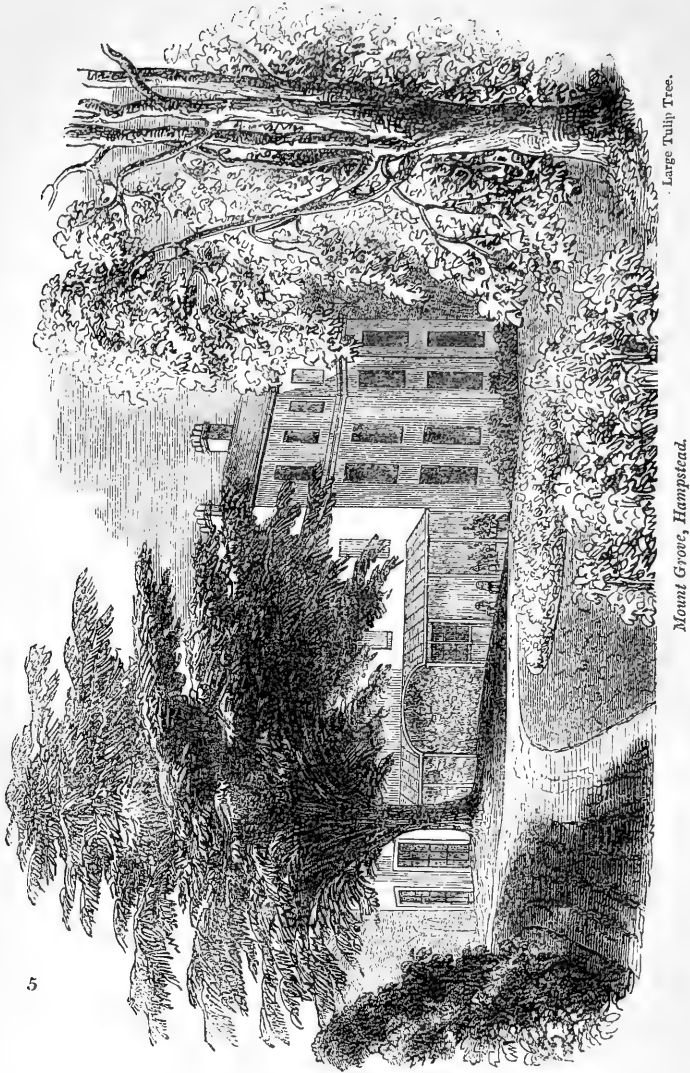
*Remarks.* In consequence of the undulations of the surface in the grounds at Mount Grove, and their extending much farther in length than in breadth, there is a very considerable variety in the interior views. This will be readily credited, when we state that the walk in the avenue A is nearly 50 ft. higher than the walk at B, and higher still than the lower side of the frame-ground, from *v* to 30 in *fig. 2*. The adjoining grounds, both to the right and left, are gardens of the same kind, well wooded; and when this is taken into consideration, combined with the extent and variety of the distant scenery, it will readily be conceived that Mount Grove is a very beautiful place. That it contains every domestic convenience suitable for the style of living of a man of wealth and hospitality is evident from the description of the house, kitchen, and stable offices: and the frame-ground contains a pinery, vinery, and peach-house, and abundance of frames and pits; which, under the care of a very intelligent gardener, Mr. Alexander, supply the family with all the principal garden luxuries; as the kitchen-garden, and the dairy, and poultry-yard, do with those articles of domestic consumption which are rarely to be procured in perfection so near London.

The two great sources of beauty at Mount Grove are, as we have already observed, the undulation of the surface, and the distant prospect; and they are the more valuable, as they are



*View looking towards the Mount.*

rarely found combined in suburban villas in the neighbourhood of London. A small place on a flat surface can very rarely boast of any distant prospect whatever; and, too often, the proprietor is obliged to be content with a hard edgy line of boundary plantation; or, if he should not be hemmed in on every side by houses, he may form breaks in his boundary line, so as to let in portions of such scenery as there may be without. No view from any place can be complete, in which the distant scenery does not form a considerable part; and in which it does



Large Tulip Tree.

Mount Grove, Hampstead.

5

not on the one hand harmonise with the foreground, and on the other blend with the horizon, or rise into the atmosphere in the form of distant mountains, and thus be comparatively lost in the clouds. However varied and beautiful the grounds of a residence may be within themselves, they will never afford full satisfaction to the mind, unless they include a portion of distant scenery. The reason is, without a portion of distance, more or less, the view cannot form a whole. To do this in the case of

landscape, there must be one portion of the scene, in which there is no limit to the eye, but the horizon. But on this subject more hereafter. There are many suburban villas on flat surfaces, where the exterior country would form a tolerable distance, provided it could be seen from the principal floor of the house; but, as the house is very frequently built without much reference to the future effect of the grounds, the error of not raising the living-floor considerably above the surface is undiscovered till it is too late.

We regret to observe that the engraver has not been so successful in his views of Mount Grove as he commonly is; a circumstance partly to be accounted for, from the difficulty in representing on wood that aerial perspective which is necessary to give distance, more especially where a great many objects are crowded together in the same view.

---

ART. II. *Some Enquiry concerning the Quercus and Fagus of the Ancients.* By H. L. LONG, Esq.

“Sprengelio omnino assentior, ‘omnem plantarum a scriptoribus seriorum sæculorum cognitionem a Theophrasto et Dioscoride proficisci debere.’ Quantopere ergo dolendum est, nomina in eorum scriptis occurrentia plantarum, de quibus adhuc parum constat, *alienis prorsus, imo novi orbis indigenis temere imposita esse.*” \*— STACKHOUSE, *Præf. in Theophrast.*, part ii.

A LOVE of the vegetable creation, particularly as exhibited in the sublime beauties of the forest, has been so generally diffused among mankind, that we may safely ascribe it to the influence of some instinctive principle in our nature. Perhaps, like parental tenderness which protects the helpless offspring from destruction, it has been wisely ordained that an interest beyond mere considerations of profit should be felt for the production and preservation of trees, in order that the fostering care of man should compensate in some degree for the inroads he is constantly obliged to make upon the woodlands, both in the extended application of the soil to agriculture, and in the continued unavoidable consumption of materials so essential to his wants. In early ages, this feeling led to the sanctity and deification of groves, whose shades inspired a religious awe; and in our own time it gives rise to some of the purest enjoyments of nature, and spreads itself daily wider and wider in connexion with the progress of refinement. This love of trees, together with an acquaintance with their history, their properties, and their uses, has an existence totally independent of a knowledge of botany; were it not so, an essay like the present would never have been attempted. A real knowledge of the science of botany is confined to a select few, to whom, as to their masters, the uninitiated, the

---

\* “I entirely agree with Sprengel, that ‘all the knowledge of plants to be found in the books of later authors has flowed from the writings of Theophrastus and Dioscorides.’ How greatly, then, is it to be lamented, that names occurring in the works of these ancient masters of the science, should be applied to plants altogether different from any which they could have contemplated, and some even to natives of countries undiscovered for many ages after their death.”

mere admirers of vegetation, look up for information in the study of their favourite objects. It must, however, be acknowledged that they not unfrequently look in vain; and an enquiry at the hands of the professors of the science sometimes induces an impression that the frequent, and apparently capricious, alterations in the names of plants is productive of much perplexity, and that the classical history of trees has been thrown into confusion by a misapplication of their original appellations. Under such impressions this attempt to extricate the Roman *Fagus*, our modern beech tree, from some difficulties has been undertaken, engaging in no botanical discussion, but merely pursuing an investigation founded upon the historical accounts we have received of the tree.

It is not a little remarkable, that two authors so familiar to us, and so free from obscurities, as Cæsar and Virgil, should each of them contain a passage in which the word *Fagus* occurs, and by its presence occasions a great deal of embarrassment among commentators. Cæsar (*B. G.*, v. 12.) asserts that the *Fagus* does not grow in Britain; and Virgil (*Georg.*, ii. 71.), in describing the wonders of the art of grafting, informs us, by that process the *Castanææ* were made to produce *Fagos*. It is just as difficult to imagine that the Beech (which composes so much of the woodlands of England, and in Saxon times conferred a name upon the whole county of Buckingham) could ever have been otherwise than indigenous to Britain, as it is to suppose that a philosophic poet, like Virgil, could ever propose to dignify by honourable notice a practice so completely at variance with common sense as that of grafting the beech upon the sweet chestnut. Abandoning, therefore, as hopeless, all the various attempts to force such a meaning from the words, I shall at once endeavour to ascertain whether the *Fagus* of Cæsar and Virgil really does signify the tree we now know by the name of Beech. The Italian appellation of the Beech is unquestionably *Faggio*, and we cannot hesitate to believe that *Faggio* is derived from the Latin *Fagus*: neither is it to be denied that the *Fagus* of the naturalist Pliny clearly means the Beech; his description of its mast is too precise and explicit to admit of any mistake. “*Fagi glans*,” he says (*N. H.*, xvi. 7.), “*nucleis similis, triangulâ cute includitur.*” Pliny, however, wrote upwards of a century subsequent to the time of Cæsar and Virgil; and it is, therefore, to anterior authors that we must refer, if, in the suspicion that the signification of *Fagus* had undergone some change, we attempt to explore the original meaning of the word.

Without offering any disturbance to the Celtic reveries of Whitaker (*Hist. of Manchester*, i. 312.), most people will be satisfied with the fact, that the Latin *Fagus* is evidently a derivative from the Greek *Phegos*; and *Phegos* as obviously originates ἀπὸ τοῦ φαγεῖν, from the circumstance of the fruit of the tree having constituted an article of human food. Roman literature, before the days of Cæsar and Virgil, had made but little progress; and, particularly in points of natural history, the Romans followed implicitly the paths pointed out by their masters, the Greeks: with the term *Fagus*, therefore, the primary signification of the word must have been introduced from the Greek writers; and, if we hope to discover it, we must have recourse to them for assistance. Theophrastus, in this matter, naturally stands forward as our principal guide; and, although his text has suffered much from vitiations, and his phraseology is abstruse and technical, a great deal may, I think, be obtained from him towards throwing light upon the subject.

The Beech is described by Theophrastus (*Hist. Plant.*, iii. 9.) under the name of δξύη\*, one point at least admitted without controversy; but the *Phegos*

---

\* The modern Romaic appellation is not very dissimilar. See Fauriel's *Chants Populaires de la Grèce Moderne*.

Τὰ πῦκ' ἀκούω καὶ βροντοῦν, καὶ ταῖς δξειαῖς καὶ τρίζουν.

“I rose at early morning, two hours before 't was day,  
I wash'd me in the streamlet to drive my sleep away;



he invariably speaks of as an Oak. Of the oaks, he informs us that the Macedonians recognise four sorts; whilst the district of Ida, still remarkable for the beauty, variety, and value of its forest trees \*, presents us with five distinct species. These he enumerates under the names of Hemeris, Ægilops, Platyphyllos (Latifolia), Phegos, and lastly the Haliphlœos, by some called Euphlœos. The scholiast upon a passage in Theocritus, which will be presently under our consideration, furnishes another (? the only other) authority for the names of the Greek oaks. The sorts of oaks, he says, are five, the Phegos, Kimeris, Etymodrus, Alyphlos, and Amylos; the first and third of this list accord with the catalogue of Theophrastus; the other three, evidently corrupt and unintelligible as they stand, are probably intended for the Hemeris, the Haliphlœos, and the Æsculus, or perhaps Ægilops. Before proceeding to examine the description left by Theophrastus of these various oaks, whose descendants, occupying the same regions, and bearing the same aspect, must meet the eye of modern travellers, it will be proper to observe that our many obligations to Pliny cannot exempt him from the blame of having thrown immense confusion upon the whole race of oaks: his account of the different species is extracted, and sometimes † verbally translated, from Theophrastus; but he brings forward all the Greek and all the Latin names he can collect, and would make it appear that each name represented a distinct tree. Thus we have the Robur, Quercus, Esculus, Cerris, Ilex, Suber, Hemeris, Ægilops, Latifolia, and Haliphlœos. By discarding more than half of these, which may be done with safety, we reduce the list, so as to agree with the number of the more accurate Theophrastus. Robur may be rejected as meaning simply the timber, or solid wood of any tree, and is applied by Virgil (*Geor.*, ii. 64.) as readily to the myrtle as to the oak. Quercus, like the Greek *Δρῦς*, is nothing more than the generic name for oaks in general. Some lexicographers have given Esculus as the Latin for Ægilops, and not without reason; the Cerris is the same as the Hemeris; the Ilex and Suber, not accounted oaks by Theophrastus (perhaps from the circumstance of their not being deciduous), are the Prinos and Phellos of the Greeks; names now most unwarrantably usurped by the broad chestnut-leaved oak, and the willow-leaved oak, from North America. Pliny's list may be thus reduced to the last four, the Hemeris, Ægilops, Latifolia (or Platyphyllos), and Haliphlœos; to which if we add the Phegos, which he curiously enough, and apparently from being at a loss for a term, translates by the word Quercus (*N.H.*, xvi. 8.), we recover the catalogue of Theophrastus in its genuine form, consisting of five distinct species.

1. The Hemeris, according to the Greek naturalist, was neither straight-growing, nor tall, but round-headed and branching, remarkable for the excellence of its timber, although in this respect unequal to the Phegos. Its fruit ranks next to that of the Phegos in sweetness.

2. The Ægilops is stated to be the most straight-growing and loftiest, possessing a smooth timber, and, for length, the strongest. In cultivated ground it is said to grow but sparingly.

3. The Platyphyllos (Latifolia) is described as second in straight growth and height, but, with the exception of the Haliphlœos, the worst as a building material, and, like that tree, unfit for carbonisation, and subject to the attacks of the worm. Pausanias especially mentions the Platyphyllos as abundant in Arcadia.

4. The Haliphlœos has a very thick bark, and a soft trunk, which, if of any size, is sure to be hollow. For building purposes it is worthless, being subject

I heard the pine trees murmur, I saw the beech trees bend,  
Where Klephtai mourn'd in anguish their captain and their friend."

*Translation by Mr. Sheridan.*

\* See Olivier's *Travels*, and P. B. Webb, *Dell Agro Troiano*.

† See *N. H.*, xvi. 8., the passage beginning "In ipsiis vero arboribus," and ending "carbone sacrificatur."

to decay even while growing, whence its habitual hollowness. It is added, that this species of oak is apt to be struck by lightning, although of no altitude.

5. The Phegos, we are told, bore a round fruit, the sweetest of all the tribe. Its timber was remarkably strong, and not subject to decay. Its growth was less straight than that of the Hemeris. The trunk was very thick, and the whole form depressed, from the circumstance of the branches not tending upwards, but forming a round head.

Such are the oaks of Theophrastus. Others, subvarieties no doubt, were to be found, like that mentioned by Olivier (*Travels*, ii. 5.), which is merely a pedunculated variety of the *Q. Cérris*, and may easily have passed unheeded. But, if we endeavour to identify these five with existing specimens, we may be well assured that the most common and conspicuous of the oaks that grow in the Levant are best suited to the enquiry.

1. The Hemeris agrees well with the *Cérris*, the Turkey, or Iron, Oak, the Romaic *Σιδηρόσταρι*. "This tree furnishes a timber that is good both in size and quality. The comparative experiments made upon this tree indicate a remarkably quick growth, without, it is said, any inferiority in the quality of the timber to that of our common English oak, either for ship-building or other purposes." (*Holland's Travels*, p. 88. and 210.) The *Q. Cérris*, observes Olivier (*Travels*, ii. 5.), "is that which is brought to the arsenal of Constantinople from the southern shores of the Black Sea, and which is most commonly employed in the framework of houses. It is also met with in a great part of Asia Minor and Syria. It grows to a considerable height, and furnishes an excellent wood."

2. The *Ægilops* is a name now affixed to the well known \* Valanida Oak, which is described by Olivier, speaking, like Theophrastus, of the oaks of Ida. (*Travels*, ii. 44.) "It grows on the western coast of Natolia, in the islands of the Archipelago, in those of Corfu and Cefalonia, and throughout all Greece; it does not rise to the height of our Turkey oak: its wood is not so esteemed, and is scarcely employed but in cabinet-work." But can this be the lofty *Ægilops*, with its timber of such excellent quality? the *Ægilops* of Theophrastus? That far better accords with the Virgilian *Æsculus*, by which name M. Alexandre and others have translated the Greek *Ægilops*.

—————"Nemorumque Jovis quæ maxima surgit  
Æsculus." VIRG. *Geor.*, i. 16.

—————"For Jove's own tree,  
That holds the woods in awful sov'reignty,  
Requires a depth of lodging in the ground;  
And, next the lower skies, a bed profound.  
High as his topmost boughs to Heav'n ascend,  
So low his roots to Hell's dominion tend.  
Therefore, nor winds, nor winter's rage o'erthrows  
His bulky body, but unmoved he grows.  
For length of ages lasts his happy reign,  
And lives of mortal men contend in vain.  
Full in the midst of his own strength he stands,  
Stretching his brawny arms, and leafy hands;  
His shade protects the plain, his head the hills commands." †  
DRYDEN.

\* The Romaic language delights in diminutives, and Valanida is the diminutive, from *βάλανος*, as affording the acorn of commerce.

† It must be admitted that this version of Dryden's, beautiful and animated as it is, falls short of the magnificent original:—

"Æsculus in primis: quæ quantum vertice ad auras  
Æthereas, tantum radice in Tartara tendit.

If the account of the Greek *Ægilops* be allowed to approximate this description of the Latin *Esculus*, so it may be safely said, that no sort of oak, with which we are acquainted, merits the sublime tribute of admiration conveyed in the verses of Virgil, unless it is our own magnificent tree, the monarch of our woods, for which all Britons still retain a druidical veneration, and would fain believe that its growth in our island surpasses that in all other countries. Throughout the greater part of Europe, however, the oak attains a magnitude beyond that of other trees. Arthur Young, viewing the woods of Lombardy, asserts (*Travels*, ii. 218.) that we have no right to arrogate to ourselves the exclusive possession of the finest oak timber. The primitive forests of Lombardy, in the days of Polybius (*Hist.*, ii. 15.), afforded pannage to innumerable hogs, the supply of the Roman markets; and the same undisturbed district might, as late as the time of Virgil, have furnished the poet with specimens of oaks,

“Sive Padi ripis, Athesim seu propter amœnum,”

worthy of the splendid portrait he has drawn. If the Greek *Ægilops* and Latin *Esculus* are not our common oak, it would be difficult to say what tree was intended by those names, or by what name our oak was known to the Greeks and Romans. Horace in speaking of *Daunia*, and *Garganum* a part of *Daunia*, seems to use *Esculeta* and *Querceta* indifferently, as if synonymous. The greater part of *Daunia* is an open champaign country; but the promontory of *Garganum*, now *St. Angelo*, was visited by Swinburne (*Travels*, i. 155.), and found still to contain a respectable forest, composed, besides pines, &c., of the evergreen and common oak.

3. We come now to the *Platyphyllos*, or *Latifolia*, next in the list of *Theophrastus*; and this, far more reasonably than his *Ægilops*, agrees with what we know of the *Valanida*; even the broadness of the leaf, from which its name is derived, does not oppose the suggestion.

4. We have, fourthly, to seek for the modern analogue of the *Haliphlœos*, and it may be found, perhaps, in another remarkable oak of the *Idæan* group. The *Quercus infectoria*, which produces the gall-nut of commerce, and is of little value for any thing else, is described by Olivier (*Travels*, ii. 41.) as bearing a crooked stem, and seldom reaching the height of 6 ft., which is not at variance with the dwarfish *Haliphlœos* of *Theophrastus*.

5. The *Phegos* now remains for consideration, and with its sweet and spherical fruit can be ascribed to no glandiferous tree now known, unless it be the sweet chestnut. The objection which first and naturally presents itself to this conjecture is, that *Theophrastus* is supposed to have described the sweet chestnut under the name of *Dios Balanum*\* (*Plin. N. H.*, xv. 25.): but the *Phegos* was in all likelihood a wilder sort, indigenous to the Greek mountains; while the *Dios Balanos*, we are told, was a superior species, improved by cultivation, and introduced originally from Asia. “*Sardibus eæ provenere primum. Ideo apud Græcos Sardianos Balanos appellant: nam Dios Balanum postea imposuere excellentioribus satu factis.*” Presuming this to have been the case, and finding nothing in what we call the oak tribe to accord with the *Phegos* of *Theophrastus*, it will be worth while to examine how far his *Phegos*, and the *Phegos* of other early Greek authors,

Ergo non hiemes illam, non flabra, neque imbres  
Convellunt: immota manet, multosque nepotes,  
Multa virum volvens durando sæcula vincit.  
Tum fortes late ramos et brachia tendens  
Huc illuc, media ipsa ingentem sustinet umbram.”

*Geor.*, ii. 291.

\* So it is supposed; but it appears to me as if *Καρύα*, or *Καρύα Ἡρακλεωτική* were the sweet chestnut (the Asiatic sort), and that the *Διὸς Βάλανος* of *Theophrastus* meant the *Jovis glans*, *Juglans*, or walnut. See note at p. 20.

may be found to correspond with the Chestnut, which covers the declivities of the mountains in the south of Europe and in Asia Minor. The circular form and sweet flavour of the fruit is the most obvious coincidence: its locality is not less so; for Theophrastus tells us that, although it has the sweetest fruit, it ranks among the *ἀγρίαι*, or wild trees, because it does not grow in cultivated grounds. "The chestnut," says Bosc (quoted in the *Arb. Brit.*, p. 1997.), "begins where the corn leaves off." The strength and durability of the timber of the Phegos may be thought objectionable, since Mr. Loudon (*Arb. Brit.*, art. *Castanea véscæ*) has combated the commonly received notion of its excessive toughness and lasting properties: perhaps the constant practice, upon the Continent, of grafting this tree, may have caused some deterioration in the timber; while in England, a non-indigenous tree is not a fair subject for a trial of strength against the native oak. It must, however, be admitted, that a chestnut, of from 30 to 50 years' growth, yields a timber fully equal to that of an oak of the same age; while, in point of size, it is generally superior, for in the first half century of its existence it is the faster-growing tree of the two. The race, however, is not always to the swift, and the oak eventually towers far above its exotic neighbour: of this fact, an example is very observable in a grove on the north-eastern side of the ancient house at Loseley Park, in Surrey, where a venerable cluster of oaks and chestnuts are seen together, indicating, by the regularity of their position, that they were probably all planted at the same time, and, by the magnificence of their dimensions that they are at least coeval with the mansion, and the growth of nearly three centuries. The oaks, still vigorous and erect, have shot up to an imposing height; while the chestnuts, although boles of great magnitude, are in a state of decay, almost approaching to ruin.

Having shown that in the brief description of the Phegos in Theophrastus, there is nothing at variance with the sweet chestnut, I shall proceed to draw some conclusions from other sources, with the view of proving that the *Fagus* of the early Romans had a similar signification. As the Latin mythology was derived from the Greek, we may expect to find that a tree consecrated to a particular divinity in Greece was dedicated to the same power in Italy. The Phegos was sacred to Jupiter. The earliest tree of the kind on record is one frequently mentioned by Homer, forming a remarkable feature in the topography of Troy. It stood near the Scæan Gate of Ilium, at the side of the road which descended from the city, by the tomb of Ilus, to the fords of the Scamander, and thence led towards the sea. This lofty tree, of singular beauty and sanctity, is almost always solemnised by the poet as the peculiar property of the "Ægis-bearing Jove." In one particular passage of great beauty, of which Pope's translation conveys but an imperfect idea, the wounded Sarpedon is supported by his companions under the shade of the Phegos, and revived by the assistance of Boreas.

"Beneath a beech, Jove's consecrated shade,\*  
His mournful friends divine Sarpedon laid.  
Brave Pelagon, his fav'rite chief, was nigh,  
Who wrench'd the javelin from his sinewy thigh.  
The fainting soul stood ready wing'd for flight,  
And o'er his eyeballs swam the shades of night;  
But Boreas rising fresh, with gentle breath,  
Recall'd his spirit from the gates of death."

In a like manner, at Rome also, the *Fagus* was dedicated to the "Father of gods and men." The learned Varro, who lived one generation anterior to Virgil, and who, probably, attached a meaning to *Fagus* in strict accordance with its Greek original, mentions the "*Fagutal*," so called from the trees which grew there; and Pliny (*N. H.*, xvi. 15.) informs us that it contained a chapel

\* 'Υπὸ αἰγίοχοιο Διὸς περικαλλεῖ φηγῶ. *Il.*, ε. 693.

sacred to Jupiter: "Fagutali Jovi etiam nunc, ubi lucus fageus fuit." Pliny here speaks of the grove as no longer in existence: we may infer that in his time it had disappeared altogether, or, being composed of the sweet chestnut, he could not recognise it as a "lucus fageus," because we know the Fagus with him signified the Beech. Indeed, he expressly mentions a most beautiful grove of beech trees, which were consecrated, not to Jupiter, but to Diana; and a very appropriate dedication this tree must have been to the celestial huntress, for its mast is the favourite food of the buck and the boar, and all the nobler animals of chase. "Est in suburbano Tusculani agri colle, qui Corne appellatur, lucus antiquâ religione Dianæ sacratus à Latio, velut arte tonsili coma fagei memoris." (*N. H.*, xvi. 91.). And its light wood was not ill adapted to the manufacture of hunting javelins:—

"Brown Exercise rejoiced to hear,  
And Sport leapt up, and seized his beechen spear."\*

Although Diana might not have contested with Jupiter any claim to the possession of the Fagus, we find another divinity deriving from the Phegos an honourable surname, which forms a point of infinite importance in settling the question as to what that tree was. We are told by Eustathius, in his commentary upon Homer (*Il.*, vi. 60.), that "Phegaeus" was a title conferred upon Bacchus, from the circumstance of the support which the Phegos afforded to the "gadding vine," διὰ τὰς ἀναδενδράδας ἀμπέλους. It would be impossible to adduce a better proof than this, that the Greek Phegos must have been the sweet chestnut; for, whether we refer to the practice of the Romans in this respect, or consult the usages of modern times, we shall find invariably that the props formed of chestnut poles are universally preferred in vineyards, just as in England the acknowledged superiority of chestnut hop poles is annually causing an increased cultivation of that tree for coppice wood. "Castanea pedamentis omnibus præfertur, facilitate tractatûs, perdurandi perviciaciâ, regeneratione cædua vel salice lætior," says Pliny (*N. H.*, xvii. 34.); and Columella (*De Re Rusticâ*, iv. 33.) gives very minute directions for the formation of Castaneta, an acre of which, he tells us, ought to produce 12,000 poles. "The chestnut is cultivated in the south of Germany, chiefly as undergrowth, for fence wood, hop poles, and vine props." (*Arboretum*, p. 1990.) Nor was Bacchus under less obligation to the Phegos, or chestnut, for its assistance in a subsequent stage, in the preparation of the grape's ecstatic juice. "French writers," observes Mr. Loudon (*Arboretum*, p. 1991.), "state that the chestnut wood is a good deal used for making wine casks †, a circumstance noticed by Rapin, in his poem entitled *The Garden*:—

"With close-grain'd chestnut, wood of sovereign use,  
For casking up the grape's most powerful juice."

Wine is said to ferment in chestnut casks more slowly, and be less likely to evaporate; it also does not contract any unpleasant taste." For this purpose the beech is, I believe, inapplicable: if, therefore, we find the "faginea materia" applied by the Romans to this use, we may augur that staves made of the wood of the chestnut are to be understood. Not only do we find authority for such an application of the Fagus in Latin writers, but we find it at a period of their literature, when, as I have before observed, we may reasonably conclude that their Fagus had not fallen away from its original Greek signification. Cato the Censor, who lived and wrote a hundred years before the birth of

\* Mention of spears formed of the wood of the beech occurs in Homer, *Il.*, ε. 50.

Ἀτρείδης Μενέλαος ἔλ' ἔγχει δξύοντι

on which Porphyrius remarks, Ἐγχεα δξύοντα, ἐξ δξύης τοῦ δένδρου ὡς καὶ Ἀρχιλοχος "δξύη ποτᾶτο," ἀλλ' οὐ τὰ δξεία, ὡς οἱ Γραμματικοὶ ἀποδεδώκασιν.

† See also Dr. Hunter's note on *Evelyn*, i. 153.

Virgil, in his treatise on husbandry (c. 21.), lays down very precise regulations for the construction of the "cupa," or "vas vinarium majus," in such a manner, and of such materials, as should render it best able to contain and preserve that divine liquor which "he loved, not wisely, but too well."\* "Intrinsic cupam *materia ulmea vel faginea facito.*" Thus, in two very remarkable uses to which the wood of the sweet chestnut is now constantly applied, as vine props and wine casks, we have evidence of a similar application of the Roman Fagus; and, from the same cause, we find an honourable augmentation of the titles of Bacchus, derived from the same word.

The Phegos, which stood in solitary beauty at the gates of Troy, must, however, yield in point of celebrity to the famous grove of Dodona, where, for more than eight centuries, the oracles of Jupiter were delivered from his favourite trees, to supplicants from every part of the then civilised world. The prophetic trees of this renowned shrine are, by Homer and Æschylus, mentioned, in general terms, under the name of Δρῦς, which included the Phegos; but the Phegos is particularised by Herodotus (*Euterp.*, 55.), in his account of the establishment of the oracles; by Hesiod (*Schol. ad Soph. Trach.*, 1181.), when he describes the fruitful district of Ellopia, in which Dodona was situated; and by all subsequent Greek authors dependent upon these original authorities. We want a good account of these forestal regions; and a report of their dendrological phenomena, at the hands of some skilful traveller, would be of the greatest interest. We know, from Dr. Holland and others, that the valleys which descend from the central mass of the Pindus chain of mountains (and one of them must be the territory of Dodona) are fringed with woods, composed of "the plane, the chestnut, and varieties of oak." (p. 88. and 210.) The beech is unnoticed, if it exists at all. These magnificent forests of Chaonia are repeatedly said to have supported the primitive race of mankind upon their uncultivated produce, until, by the bounty of Bacchus and Ceres, the world

"Chaoniam pingui glandem mutavit aristâ,  
Poculaque inventis Achelôia miscuit uvis."

The fruit of the sweet chestnut might certainly have afforded a repast to uncivilised man, being even now in great estimation; but whether, under any circumstances, the acorn of the oak could have been the common food of our species may well be doubted. A single exception in the nauseous austere flavour of the acorn occurs in the Spanish ballota, which Ceres had not expelled from desserts in the time of Pliny, "Quin et hodieque per Hispanias secundis mensibus glans inseritur" (*N. H.* xvi. 6.); and which still enjoys a reputation for excellence: but this is the produce of a species of *Ilex*, the gramúntia, or Grammont oak, and, beyond the limits of Spain, appears to be unknown in Europe. When Circe throws before the transformed companions of Ulysses the acorns of the ilex and the oak, and the fruit of the cornel, the poet expressly adds, "such as is always the food of grovelling swine."

——— Τοῖσι δὲ Κίρκη  
Πάρ ῥ' ἄκυλον, βάλανόν τ' ἔβαλεν, καρπὸν τε κρανείης,  
Ἔδμεναι, οἷα σῦες χραιμευνάδες αἰὲν ἔδουσιν. *Odyss.*, κ. 241.

That such food, if it ever were human food, should have fled at the approach of Ceres we may readily believe; but, if we find the Phegos still retaining its ground, and associated with the gifts of the goddess in an advanced state of civilisation, it is not unreasonable to suppose that its fruit must have some standing merit, very distinct from the other wild productions of the forest. Such is the Phegos described by Plato and Theocritus as a primitive and pastoral diet suited to a country life, but, with its concomitant delicacies, forming a banquet such as neither philosopher nor poet would have declined to join.

\* "Narratur et prisci Catonis  
Sæpe mero caluisse virtus."

As appertaining to the present enquiry, their words convey some interesting facts. After the cakes of barley and wheat flour, which his citizens are to prepare for their repasts, Socrates enumerates several salubrious and quiet articles of food, not very much to the relish of all his hearers, and concludes by recommending that, with their moderate potatoes, they should "roast in the ashes the φηγός," i. e. fruit of the Phegos. "Καὶ φηγὸς σποδοῦσαι πρὸς τὸ πῦρ, μετρίως ὑποπίνοντες." (*Plato de Repub.*, ii.) In Theocritus (*Idyl.* ix. 15.), Menalcas, "the son of Etna," a person possessed of considerable flocks of sheep and goats, extols, in joyous verses, the happy life of a shepherd, housed safely in his mountain cave against the blasts of winter: —

"Etna's my parent! There I love to dwell,  
Where the rock mountains form an ample cell;  
And there, with affluence blest, as great I live  
As swains can wish, or golden slumbers give.  
By me large flocks of goats and sheep are fed,  
Their wool my pillow, and their skins my bed."

*Fawkes's Translation.*

He then adds: In the winter season, "the meats boil over the oak fire, in the fire the dry φαγοί" are roasted.

Ἐν πυρὶ καὶ δρυῖν φάγια ζεῖ, ἐν πυρὶ δ' αἶαι  
Φαγοί.

In these passages, it is impossible not to perceive that no other fruit than that of the sweet chestnut can be meant; and, if the Greek φηγός, or, as we have it in the broader dialect of Theocritus, the φαγός, is admitted to mean the chestnut, it follows that the Latin derivative *Fagus* ought to have the same signification. Homer, Hesiod, and Theocritus were, beyond all other poets, the objects of Virgil's imitation; and we may, with much confidence, expect to find the same meaning conveyed by his *Fagus* that we have, I think, discovered to belong to their Phegos. If we examine Vir. il's allusions to the *Fagus*, we shall not perceive, in any one instance where the word occurs, an objection to its being translated as the chestnut. Thus, for example, in the 3d *Georgic*, the words "*faginus axis*" describe the axletree of a chariot; an evident translation of the φήγωνος ἄξων of Homer (*Il.*, ε. 838.). Homer clearly does not mean that the axle was made of beech wood, for the δέση is his beech; nor would either poet have selected so brittle a material as the beech for a chariot entrusted with the safety of heroes, and destined to endure the violent concussions of battle or the Olympic games. "*Facilis*," says Pliny, "*est Fagus, sed fragilis et tener.*" (*N. H.*, xvi. 84.) His *Fagus*, therefore, could scarcely be the *Fagus* of Virgil. The carved goblets, the monuments of the skill of the "divine Alcimedon," are stated to have been "*fagina pocula*" (*Ecl.* iii. 37.): it is scarcely possible to suppose that the gifted artist would have confided the treasures of his skill to a wood so apt to split and spoil as the beech; for, although it may be applied, in England, to the formation of bowls for the commonest household purposes, we well know, to our cost, the extreme frailness of the material. Virgil, as it has been frequently remarked, has exercised a very felicitous choice in the epithets he applies to the *Fagus*, each being so applicable to the beech. Some of these, however, (such as *densas*, *umbrosa*, *veteres*, and *alta*.) may be passed over, as the common property of almost any species of tree; but *patulæ*, the famous "*Tityre, tu patulæ recubans sub tegmine fagi*," in spite of all our earliest prejudices, is even more applicable to the chestnut than to the beech. Of the beech Mr. Loudon remarks (*Arbor.*, 1954 and 1970.), that the branches, with certain exceptions, generally take an upright direction; while the chestnut resembles in its growth, although it cannot equal, the majestic diffusion of the oak. "The branches form nearly the same angle with the trunk, as those of the oak." (*Arbor.*, 1985.) We must, however, pause a moment to consider one very characteristic peculiarity, the smoothness of the bark of the beech.

"No bark tempts the lover so much to make it the depository of his mistress's name," says Gilpin; and Virgil (*Ecl.* v. 13.), most assuredly, has recorded an inscription, "viridi in cortice Fagi," "upon the green bark of a Fagus." The stem of the chestnut, when the tree has attained maturity, we know to be covered with a rugged intractable rind, utterly unfit for the reception of any legible characters; but the bark of a youthful chestnut, a tree of thirty or forty years' growth, presents a tablet of smoothness and beauty fully equal to that of the beech. It is not impossible that the epithet "viridi" may be correctly interpreted "young;" for, generally speaking, while the surface of the bark of the beech is covered with a thin deposit of very white fungus, that of the young chestnut is decidedly green. Having compared the bark of both species, and experimentalised upon them with the knife,

———"servant incisæ nomina Fagi,  
Cœnone legitur falce notata mea,"

I can pronounce that the youthful chestnut is quite in sufficient harmony with the "viridi in cortice," to assert its right to the expression. The locality of this tree, so often noticed by Virgil, on the banks of the Mincio, "qua se subducere colles incipiunt," is highly suitable to the geographical position of the chestnut, which covers, in such beautiful profusion, the declivities of the Alps, on the Italian side; and which, throughout Italy, is a tree of far greater notoriety than the beech. Count Stolberg (*Travels*, ii. 475.), possessing all the enthusiastic veneration for the beech due to that magnificent tree, in true allegiance, from a native of the Hercynian Forest, in the midst of his transport on beholding the matchless chestnuts of Mount Etna, tells us, "that on the side towards Nicolosi it is covered with oaks, and *some beeches*, the sight of which gave us greater pleasure, because this charming tree is *seldom* met with in Italy and Sicily; but neither the tree nor its foliage *attain* the same beauty here as they do in our country."

It remains now to apply the result of this investigation to the passages in Cæsar and Virgil connected with the Fagus, in which so much difficulty is experienced; which difficulty, by translating the word "chestnut," instead of "beech," will, I think, be most satisfactorily overcome. The passages have been commented upon in the *Arboretum* (Introduct. p. 21.); and, in reference to those remarks, I have been induced to state some grounds for the opinion\*

---

\* The opinions alluded to in the *Arboretum* are given as follows:—"Cæsar says that Britain supplies timber of all sorts, like Gaul; 'præter fagum atque abietem,' which is supposed erroneously to mean the beech and the fir. By Fagus we are to understand the *Fagus Castanea*, or Spanish chestnut, and by Abies, the silver fir; neither of them indigenous to our island, although they flourish when planted." As far as the Abies is concerned, the foregoing explanation is admitted to be simple and satisfactory; yet what a strange departure from its old classic name we have in this very silver fir. The uninitiated might have expected that Abies would certainly have formed one of its cognomina; yet the Linnæan *Pinus Picea* is now exchanged for the *Picea pectinata*, and the original Abies sedulously excluded. With regard to the epithet "pectinated," the leaves of the silver fir do certainly correspond with the figure of a comb; but it may be questioned if Stackhouse, in the preface to *Theophrastus* (vi. vii.), is correct in the interpretation and emendation he has bestowed upon the Greek account of the Elate, or silver fir. Theophrastus (iii. 8.) describes the tree as having "branches like wings, gradually diminishing, so that its *whole form* resembles a 'tholos,' or cupola, much in the shape of the Bœotian helmet." This description, applied by Theophrastus to the *whole tree*, is reduced, by Stackhouse, to be intended for a delineation of the *leaf* only; and, instead of *κυνέαις*, helmets, he proposes the word *κρανέαις*, combs: "Licet conjicere *κρανέαν Βωωτίαν* dentibus utrinque ex adverso instructam fuisse, ut in *combis* et eburneis nostris; Angl. a double-toothed comb." What sort of *combs* was used by the Bœotians, or whether they used



“that the tree Cæsar called the Fagus was the sweet chestnut, *Fagus Castanea L.*” If those grounds are thought to be substantial, Cæsar’s gratuitous denial of the existence of the Fagus in Britain no longer excites surprise. The vast forests of chestnuts, covering the base of the mountains in both Cisalpine and Transalpine Gaul, could not have escaped the eagle eye of Cæsar; and the non-appearance of the tree in the woods of the Cæntii and the Cassii of Britain would have been equally remarkable; while the information he obtained from other observers, which, as far as it goes, we know to have been singularly correct, confirmed him in his statement that the Fagus was not to be met with in the island.

The difficulties attendant upon the passage in Virgil are not, however, disposed of with the same facility. What does the poet say? In his account of the perfection at which the art of grafting had arrived, he exclaims:—

“The thin-leaved arbute *hazel* [*? walnut*] grafts receives,  
And planes huge apples bear, that bore but leaves.  
*Thus mastful beech the bristly chestnut bears,*  
And the wild ash is white with blooming pears.  
And greedy swine from grafted elms are fed,  
With falling acorns, that on oaks are bred.”

*Dryden’s Translation, Georgic ii. 96.*

In the original “*Castanæ Fagos,*” the chestnut is brought to produce the “Fagos,” commonly understood to mean the “beech mast;” that is, the better tree is sacrificed, by grafting, to the worse, a supposition unworthy of both poetry and philosophy, and, as such, very naturally productive of much clamour among the commentators on Virgil. No manuscript sanctions any alteration in the text, nor can any thing justify the supposition of Servius, that, by the miraculous agency of the grammatical figure *Hypallage*, we are to understand the very reverse of what is stated. Even Pliny seems somewhat at a loss for the meaning, for he omits all mention of this, when he speaks of the other exhibitions of the powers of grafting. (*N. H.*, xv. 17.) “*Pars hæc vitæ jampridem pervenit ad culmen, expertis cuncta hominibus. Quippe cum Virgilius insitam nucibus arbutum, malis platanum, cerasis ulmum dicat, nec quidquam amplius excogitari potest.*” Professor Martyn (*Virg.*, vol. ii. p. 150) has, indeed, cut the Gordian knot, by assuming that the ancients actually gave a preference to the fruit of the beech over that of the chestnut. Were this the case, a most extraordinary change must have taken place, either in the flavour of the nuts, or in the palates of the human race. He supports his assumption by the authority of Pliny; who, he says, “mentions chestnuts as a *very sorry sort of fruit*, and seems to wonder that nature should take such care of them as to defend them with a prickly husk. “*Armatum iis echinato calyce vallum, mirumque vilissima esse quæ tantâ occultaverit curâ naturæ.*” (*N. H.*, xv. 25.) It is more wonderful that the professor should not have perceived that *vilissima* by no means corresponds with his word *sorry*, but merely signifies “*most plentiful and cheap.*” True it is that Pliny says “*Dulcissima omnium fagi,*” which he seems to translate from Theophrastus, “*γλυκίτατα δὲ τὰ τῆς φηγῶς;*” and adds, “*ut quæ obsessos etiam homines durâsse in oppido Chio, tradat Cornelius Alexander.*” Under the scourge of famine, it is not surprising that the Chians should have subsisted upon beech mast, if they could procure enough; under similar circumstances, rats and horseflesh are accounted dainties: but, after all, it becomes a question whether the Greek authority for this story might not have written “*φαγοί,*” which Cornelius Alexander would have Latinised by “*Fagi,*” meaning the chestnut; trees far more likely to have grown in Chios, or to have sent their fruit from the neighbouring coast of Asia Minor. Our countryman Grimbald, or Grimoal-

---

any at all, we know not; but there is sufficient authority (*Pollux*, i. 10.) to presume that they were remarkable for their *helmets*.

dus, has approached nearer the meaning of Virgil. "Grimoaldus thinks that the poet means a wild sort of chestnut, which might be used as a stock upon which to graft the beech." (*Arboretum*, 1956.)

I submit, with much confidence, that the true explanation of this very difficult passage in Virgil is to be discovered in a practice then, and still later (in the time of Pliny), extremely rare, and considered extremely curious, but now so common that it pervades the whole of Europe wherein the chestnut is grown; I allude to the practice of grafting the chestnut upon itself, that is, the improved sort, the *Fagus*, which the Romans derived from the Greeks, and the Greeks from the Asiatics, upon the wilder stock, the *Castanea*, which flourished in its native mountains, from the Pyrenees to the Euxine. The difference between the *châtaignes* and the *marrons* is strongly marked in France; "the former being to the latter what the crab is to the apple." "In many countries where the chestnut trees are cultivated, the people graft the largest and the fairest fruit upon stocks raised from the nut: all these grafted trees are by the French called *marronniers*, but they are unfit for timber." (Hunter's note to *Evelyn*, i. 154.) However common it may be now, it was certainly looked upon by Pliny as a most extraordinary performance, and worthy of especial notice: "Non est omittenda raritas unius exempli. Corellius, eques Rom., Ateste genitus, in sevit *Castaneam suometipso surculo* in Neapolitano agro, sic facta est *Castanea* quæ ab eo nomen accepit, inter laudatas. Postea Etereius, libertus, Corellianam iterum in sevit. Hæc est inter eas differentia, illa copiosior, hæc Etereiana melior." (*N. A.*, xvii. 17.) Palladius also (xii. 7.) mentions the same fact: "*Castanea* inseritur, sicut probavi ipse, *insevitur in se.*" This confidence in the interpretation of Virgil's *Fagus* here put forth is not shaken by the circumstance, however unaccountable, of the word having changed its signification between the days of the poet and those of Pliny. Symmachus (*Macrob. Saturnal.*, iv. 14.) demands: "Vellem ex te audire, Servi, tanta nucibus\* nomina, quæ causa vel origo variaverit?" This question may not, in the case of the *Fagus*, admit of a satisfactory answer; but we may gather from it that changes had occurred, as they are at present of every-day occurrence. At all events, we may be permitted to presume that the mystery of grafting the chestnut upon the chestnut, the *Fagus* upon the *Castanea*, as mentioned by Pliny and Palladius, was not unknown to Virgil, although it might have been confined to the gardens of Greece alone. Under this conviction, the perplexity of the passage is entirely removed; no grammatical figure need be called upon for its assistance; the text may stand unmoled and unsuspected; and Virgil appears intelligibly in his natural character of poet, rural economist, and philosopher.

Hampton Lodge, October, 1838.

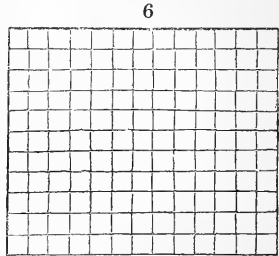
\* The chestnut was accounted a *nut* by the ancients, and classed by Pliny among the *frugiferous* trees; whereas the beech ranks with him as the best of the *glandiferous* tribe. "*Nuces* vocamus et *castaneas*, quanquam accommodatiores *glandium* generi;" an arrangement which (without any view apparently of following Pliny, but led by the same principles) has been adopted by the author of the *Encyclopædia of Gardening*, p. 1142: "The Spanish chestnut has been already described as a *fruit tree*." The Greeks also reckoned the improved chestnut as a *nut*; Nicander, for instance, where he gives the origin of its name: "*Δυσλέπειος καρύωιο, ἣν Κάστανος ἐγράφεν αἶα.*" Theophrastus, by his *καρύα*, or *Ἡρακλεωτική καρύα*, probably means the Asiatic chestnut; for his *Διὸς βάλανος* is far more likely to have been the Jovis glans, or walnut. This would appear from the words of Opilius (*Macrob. Saturnal.*, ii. 14.): "*Heraclæotica hæc nux, quam quidam castaneam vocant.*" In Virgil's lines (*Georg.*, i. 187.),—

"Contemplator item, ubi *nux* se *plurima sylvis*  
Induet in florem, et ramos curvabit *olentes,*"

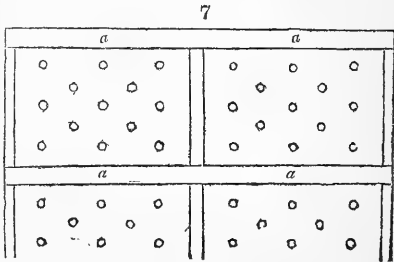
the *nux* is said, usually, to mean "the almond." Professor Martyn is strenuous for its being the walnut; but the expressions of "abundant in the

ART. III. *Some Account of a Box for the Propagation of Cape Heaths.* By N. M. T.

I HAVE constructed a box for the propagation of heaths, that perfectly answers the purpose; and, as it contains a greater number of cuttings in the same space, and occasions less trouble than any other method I am acquainted with, perhaps you may consider a description of it worth a place in your Magazine. The box, inside, measures 9 in. deep; the bottom part, to the depth of 5 in., is filled with drainage, moss, and heath soil, well compressed, and perfectly level, to support a frame of lath-work 1 in. deep, and divided into 120 divisions, each measuring 3 in. by  $2\frac{1}{2}$  in. (*fig. 6.*) On the top of each division, at *a*, is written the name of the species that occupies the space beneath. (*fig. 7.*) This frame is lowered, until it rests upon the materials already in the box; the compartments are then filled with sand, which is pressed down with a piece of wood made to fit them. When the cuttings are inserted in the sand, they stand 2 in. or  $2\frac{1}{2}$  in. from the top of the box, which is covered with a glazed frame formed of four squares of glass, supported by very slight copper bars, as shown in *fig. 8.*, and fastened to the box by hinges at the back, and fastenings at each corner in front; and, as a piece of list is nailed round the top of the box, when shut, it is nearly air-tight. The smallness of the compartments gives it, at first sight, rather a toy-like appearance, but each of them will hold ten or more cuttings of most sorts, with which the most bungling operator may continue any private collections: and, should any nurseryman adopt it, he can easily allow more space, or cover the whole of a propagating shelf in the same manner. The names being fixed will be found a great advantage, as the ease with which tallies are displaced greatly contributes to increase the mass of confusion in which we find the names of too many collections. In a box containing 120 species, many rapid-



6



7



8

forests," and "weighing down the branches with its odorous bloom," sound much more like the *chestnut*, so plentiful in Virgil's country, and so very remarkable for the overpowering scent of its blossom.

growing sorts will root much sooner than others; the compartments, being entirely independent, admit of such being moved, without in the least disturbing their more tardy neighbours. Drainage to the depth of 5 in. is not actually necessary, but, when the box is not used in propagating heaths, it may be filled with any other class of plants, and reducing the drainage admits those of taller habits. I consider that it might also be advantageously employed in raising Australian or other seeds that delight to germinate in a moist atmosphere. Altogether, I think it preferable to a number of pots with bell-glasses.

*Folkstone, Oct., 1834.*

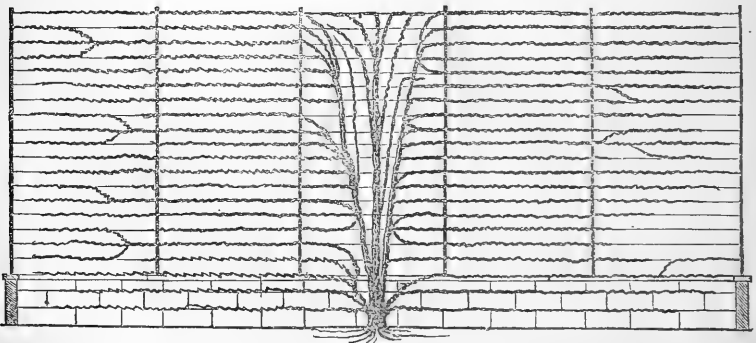
---

ART. IV. *Notice of a remarkable Specimen of Cereus speciosissimus, growing in the Stove of Thomas Holman, Esq., at Folkstone, in Kent. By N. M. T.*

It has often struck me, when reading in the *Gardener's Magazine* accounts of remarkable specimens of trees or shrubs, that it would be very desirable to have as many records of such specimens as possible. These records, while they encouraged some, by showing them what might be done, would moderate the opinion of others in respect to plants in their own possession, which they would, probably, otherwise consider much finer specimens than they really are. In this point of view, the exhibitions at the Floral and Horticultural Societies have done, and continue to do, much good to the gardener, who has, perhaps, little opportunity of seeing any garden but his own; but I am forgetting my *Cereus speciosissimus*.

This plant, which is represented in *fig. 9.*, was planted in the pit of the stove of Thomas Holman, Esq., at Folkstone,

9



and trained to small copper wires, stretched horizontally, 4 in. apart, across a row of posts that separate the pit from the back

path. The trellis thus formed is 25 ft. by 8 ft., so that the plant covers, with its shoots only 4 in. apart, a space of 200 square feet. Until November last, it stood in the middle of the same pit, and grew at random; but it occupied so much room, that removal or cutting became necessary. When the present plan suggested itself, a great deal of the actual size of the plant was unavoidably lost, in reducing it to its present figure. It suffered little from being moved; and, during the time of flowering, there were often from thirty to fifty of its magnificent flowers expanded at once, forming a most splendid object. The centre shoot is carried over the path, and trained on the back wall, to form an exact counterpart to that already on the trellis; when this is completed, it will form a path literally beset with thorns; and prove, perchance, the finest specimen of the sort in Britain. In the meantime, I should like to know where there is one to match it in its present state. — *Folkstone, Oct., 1834.*

---

ART. V. *The Result of certain Experiments in cultivating different Varieties of Wheat.* By JOHN RIVERS.

AGREEABLY to your request, upon the distribution of M. Vilmorin's wheats in 1836, I with pleasure communicate the result of my experience of the two seasons they have been in my possession. In the first instance, I am convinced of the erroneousness of the idea so very general amongst farmers, that wheat (like the *Brássica* tribe) is subject to promiscuous impregnation: such is not the case, except under very extraordinary circumstances; a proof of which is, that each distinct variety remains the same at present as it was seven years since, when they were grown in the Chelsea Botanic Garden. As a convincing proof, the small kinds, of which the botanical character is more difficult to discover, will be found, upon the examination of the sample, to be complete and permanent.

It is evident that plants are subject to the same laws of adaptation to soil and climate as animals; but still this adaptation does not take place in the first instance, though it shows itself in the future generation. It is apparent, also, to observation, that a variety adapted to the soil is less likely to degenerate; as instances are common of wheat having been grown upon one soil for nearly a century, without change of seed, by merely using the precaution of having the most perfect ears cleaned, and saved for future seed. A sudden change of soil, or thinness of the plants on the soil, may effect a trifling alteration in the formation of the ear; but the original properties will remain permanent and distinct. The manner in which I have grown the numerous varieties of wheat which you were so kind as to send

me, is as follows: — They have been dibbled upon a stitch (furrow-slice) of land, in the centre of a 12-acre enclosure, sowing three grains in each hole, average distance 5 in. from each other. They have been managed precisely alike, and no other distinction made than their division by labels; and, to prove their respective merits, they have been tested with all the most approved British varieties, including the Chevalier, the Whittington, and my own White Cluster. The result of last year's experience is corroborated by this; viz. that there is a considerable advantage in the cultivation of some kinds in preference to others; and, if the number of acres sown with inferior kinds (which are preferred by the bakers, in consequence of their yielding a meal which rises better in bread) were sown with the superior kinds, the advantage would be immense to the population at large. The only fault complained of in the new kinds, which are certainly much more productive, is, that the flour made from them does not rise in the loaf; a trifle always obviated by the London bakers by the addition of a harmless substitute. I have much reduced the collection, as I could not discover any more than twenty-two distinct varieties, instead of fifty-eight; added to which, fifteen of British make thirty-seven kinds, which is a rather numerous collection. It must be admitted that, among the white sorts, the new kinds of British, more especially the White Cluster, are superior in quality and quantity; Brown's ranks second, and Whittington third. The red-chaffed wheats are not, by any means, equal to the white ones; but yet the Cone and Revel are two kinds which have proved much superior to the British in productiveness, though not in quality; they are also certainly much more robust, and better set in the ear; but seasons vary, and it requires some years before an accurate judgment can be formed of their respective merits. — *Sawbridgeworth, Oct. 18. 1838.*

---

ART. VI. *Notice of an Experiment made with Four Seeds of Wheat, sown in June, 1836.* Extracted from a Letter received from Mr. GORRIE.

I MAY take this opportunity of thanking you for four seeds of wheat, which you had from Dr. Hamilton, in June, 1836, and which you kindly forwarded to me with the doctor's note, expressing a wish that they might be sown immediately, to try and get seed that season. In compliance, I put one seed in a pot in a hot-bed, which came up weak, and ultimately mildewed. One seed I dropped in the open ground: this came up strong, with exceedingly long leaves; but, in September, it did not appear to run to seed; I therefore cut it over close by the ground, and left it to withstand the rigours of winter. It survived, and last spring tillered beautifully, and grew unusually tall; it showed a fine long ear bearded: and, although called the Black-jointed

Tremois, it was rather late in ripening. Forty-two shoots sprang up and showed fine ears: I allowed the whole family to grow together from one root, without transplanting, protecting them from birds; and threshed, or rather rubbed, out from this one well-tillered plant 1334 grains of good ripe wheat, every grain of which I have sown in drills. All have come up beautifully, and will this year, I doubt not, yield a finer sample than their luxuriant predecessor, which, from the excessive luxuriance of the plant, yielded a much coarser wheat than the grains I received. One of these I have preserved for comparison, and the remaining one was bruised before it reached me.

*Annat Cottage, Jan. 13. 1838.*

---

ART. VII. *On the Calling of the Queen Bees before Swarming.*

By JOHN WIGHTON, Gardener at Cossey Hall.

THE remarkable sound, like "Peep, peep," when heard in beehives, is a certain sign of approaching swarming. Some apiarians have thought that this sound proceeded from the rival queens quarrelling. I believe this to be erroneous; and that the noise is made by the young queens calling before they leave their cells. At first the sound is uttered very faintly, but it increases with the growth of the queens. It will be objected that most of the early apiarians believed this sound to proceed from contending queens; and used to observe that a swarm would soon go forth, when the sound came from lower down in the hive. I consider this a mistake; and that the sound in such cases came from the cell of another queen situated lower in the hive. If the noise were made by rival queens fighting with each other after leaving their cells, it would be heard from various parts of the hive; but I have never heard the sound but from certain fixed points.

This season I had, in one of Mr. Nutt's hives, a queen's cell so situated near a glass, that I could observe the larva before the cell was sealed up. From this cell proceeded at first a weak sound of "Peep, peep;" and then a similar sound was heard from other cells, but always from determinate points. The calling of three queens in their cells lasted four days before swarming. About an hour before the swarm came off, I observed a queen bee going round and round the cell above-mentioned. The young queen was still within it; but no sound was heard from it at the time, nor was there any appearance of their fighting. After the swarming, I found two young queens cast out dead. One of these might have left her cell, but the other was too young to have done so, and must have been cast out by the bees. As I had previously heard three separate calls from three fixed points, the sounds I believe to have come from these queens while in their cells. As one of the calls was very

weak, it probably proceeded from the very young queen, who, as I conjecture, was afterwards cast out of her cell.

As this calling by the queens is a sure forerunner of a swarm, it may be asked why it is not heard before the first swarm. The only answer I can give is, that probably the old queen quits the hive with the earliest swarm, leaving the young queens in a larva state, who are not able to call till eight or ten days afterwards.

I shall be gratified if the above remarks on a very curious fact relating to bees should induce others of your readers to pursue the interesting investigation, so that we may arrive at satisfactory proof that this calling proceeds from the queens, previously to quitting their cells. — *Cossey Hall Gardens, August 16. 1838.*

## REVIEWS.

ART. I. *The Green-house, Hot-house, and Stove; including select Lists of the most beautiful Species of exotic Flowering Plants, and Directions for their Cultivation.* By Charles M'Intosh, F.H.S., Gardener to His Majesty the King of the Belgians, and Author of the "Practical Gardener," &c. 12mo, pp. 415. Numerous woodcuts, and 16 coloured plates. London, 1838.

ONE reason given for the production of this work is, "that we have no modern treatise especially devoted to the management of the green-house;" the author having forgotten, or not having seen or heard of, *The Green-house Companion*, an 8vo volume, of which a new edition has recently appeared. However, no apology is ever necessary for the production of a good and useful book, which we can, without hesitation, affirm this to be. It is also rendered highly ornamental by the introduction of eighteen groups of exotic flowers, printed in colours, according to the new process of Mr. Baxter; which, though not very accurate in a botanical point of view, are yet sufficiently so to be recognised for what they are meant to represent, and which form very conspicuous ornaments to the book. The arrangement of the work is as follows:—

Introduction, in which a slight sketch is given of the progress of the cultivation of exotics; from Seneca and Martial, who are said to have understood both retarding and forcing, to the Dukes of Devonshire, Northumberland, and Bedford, who deserve "honourable mention" for maintaining their gardens with princely liberality. Green-houses in general are noticed, and the following judicious observations will merit the attention both of the professional gardener and the amateur:—

"As to cultivating a general collection of plants in the same house, although very generally attempted, it is by no means to be recommended. The treatment of different families of plants varies so much at certain seasons, that the best cultivators have found, from that sure test, experience, that it is better to appropriate separate houses to such families as nearly agree in culture and habit.



“ Such is our view of the subject. Plants, to be well cultivated, ought to be divided into groups, in a somewhat similar manner to that sketched out in the following pages. The cultivator who shall direct his attention to one, two, or more of these divisions, according to his taste and circumstances, will be much more amply repaid than if he were to congregate plants of discordant habits and of different climates into one habitation, merely for what he may choose to call variety, or a rich collection of species. The mania for accumulating species, instead of forming judicious selections of good flowering plants, has produced very baneful effects in the English gardens; not only by excluding old and good plants, merely because they had long been denizens amongst us, but by introducing many which have no other merit to recommend them than novelty. How many of the plants of New Holland are cultivated, scarcely worth the pot in which they grow, otherwise than in a botanical point of view; as may be instanced in the genera *Eucalyptus*, most of the *Hakea*, *Tetraphylla*, and *Isopogon*. We repeat, that if greater attention were paid to the selecting of fine flowering plants, and cultivating individual specimens well, instead of crowding our green-houses with inferior plants to the destruction of each other, they would present a very different appearance to what they usually do. Next to forming selections, instead of attempting collections, we would recommend to cultivators, and to amateur cultivators in particular, to confine their culture and attention to some one of the divisions we have enumerated. In this respect, our Continental neighbours far excel us, and, by confining themselves to the cultivation of certain families, they have become conspicuous in these departments.

“ How far the florist has excelled the general collector in this particular we need hardly state; by confining himself to his tulip bed, his auricula stages, or his carnation stand, he is enabled to cultivate them in great perfection; not so the general collector: the florist has the economy of those three families to study, while the general cultivator has probably that of three thousand; and those congregated from the most opposite quarters of the globe, and existing under the greatest diversity of circumstances. We might justify these opinions by referring to the success with which Messrs. Rollisson of Tooting cultivate the *ericas*, and latterly the *Orchidæ*; and of Messrs. Chandler of Vauxhall, in the cultivation of *camellias*, were such proof necessary; but it speaks for itself, and the same reason applies to every pursuit of mankind; where undivided attention is given to any of our pursuits, an approximation to perfection in that pursuit may be expected. The divisions or groups into which we should like to see all green-house exotics arranged, would be something like the following:—

“ The Heathery.	The Orangery.
The Geranium-house.	The Conservatory.
The Camellia-house.	The Plant Veranda.
The Bulb-house.	Protecting Tent.
The Succulent-house.	Cold Pit.
The Mixed Green-house.	The Stove.”

Mr. M'Intosh has not added the aquarium; because, most exotic aquatics being untropical, he defers the subject till he comes to treat of plant stoves.

Hot-house architecture is next treated of, chiefly by a long communication from Mr. Thompson, the author of a pamphlet reviewed in our preceding volume (p. 486.). “ All horticultural erections,” Mr. M'Intosh is of opinion, “ should be of wood, in preference to metallic matter; not only because of its greater economy and fitness for the purpose, but also on account of durability and elegance of effect.”

"We have availed ourselves of Mr. Thompson's opinions, because he had ample opportunities of drawing unprejudiced conclusions during the period he had the direction of the extensive hot-houses at Syon, which have been considered the perfection of metallic houses. To his testimony we might add that of many others of equal credit; but we shall conclude by referring the reader to the opinions of Mr. Paxton of Chatsworth, Mr. M'Murtrie of Shughborough, and Mr. Thompson late of Welbeck, published in the *Transactions of the Horticultural Society and Horticultural Register*. For ourselves, we only know of one architect who has attained any celebrity in hot-house architecture, and that is W. Atkinson, Esq., of whose improvements we shall have occasion elsewhere to allude." (p. 11.)

Mr. M'Intosh next takes a survey of the different modes of heating, by flues, steam, and hot water. The best mode of heating by steam he considers to be that of Stothert of Bath; and, unlike our friend Mr. Forsyth, he approves of Kewley's mode of heating by hot water. "Nothing," he says, "can act better than Kewley's siphon; and we believe that it is at present by far the most popular of all other modes." (p. 42.) The following is a summary of Mr. M'Intosh's opinion on this important subject: —

"Of all these methods of heating by means of hot water, our opinion is briefly thus: — that, for ordinary purposes, in green-houses and stoves, when the level circulation can be adopted, Atkinson's original method is the best; and although, perhaps, not cheapest in the first erection, is unquestionably so in the end.

"When the circulation is to be carried over doors, or under footpaths, or, indeed, out of a regular level, Kewley's siphon system is the most to be preferred.

"And when the greatest possible degree of heat is required, and only a limited space for the apparatus, that of Perkins is certainly the best.

"For heating small green-houses, balconies, &c., from the fire used for other domestic purposes, that of Curator Anderson is, in our opinion, the most simple and efficient one.

"By any of these four methods a house, however situated, can be completely and economically heated. We have elsewhere stated our opinion, that, for the ordinary purposes of green-houses, it is scarcely worth while erecting hot-water apparatus at all, where smoke flues can be built cheaper, and without interfering with the internal arrangements of the house. But, for stoves and other forcing-houses, where a higher degree of temperature is required for three parts of the year, there can be no doubt of the superiority of hot water over every other mode, both as regards economy and convenience."

Mr. M'Intosh is not only decidedly against the use of iron in green-houses, as we have already seen, but he objects to curvilinear forms. "We are only surprised," he says, "after the opinions of competent judges have been so frequently laid before the public, that houses of curvilinear forms, and of metallic materials, should not have been, long before now, entirely expelled from our gardens." (p. 53.)

We were less surprised at the above opinion, than at the following: —

"Much has been said of late years, and, we believe, to very little purpose, upon the angle which the roof of a hot-house

should present to the horizon. . . . The *Horticultural Transactions* and the *Encyclopædia of Gardening* contain a variety of opinions on this subject; but, so far as we know, few hot-houses have been erected with much attention to the niceties of these theories." (p. 54.) See *Penny Cyc.*, art. Hot-house.

In looking over the work, we found the following interesting and original information, contributed to it by Mr. Beaton, the scientific and eminently successful gardener of James Harris, Esq., F.H.S., of Kingsbury:—

*Cacti.* Mr. Beaton is of opinion that the genera *Cactus* and *Mammillària* are not distinct. *Mammillària* is generally considered as destitute of a woody axis, or central column; but Mr. Beaton asserts that all the sections of the genus *Mammillària* have not only a woody axis, but a medulliferous column in the centre of this woody axis, like other exogenous plants. The axis is not formed during the first few years of the plant's existence, and this is what has led botanists astray. Mr. Beaton is of opinion that *Melocactus*, *Echinocactus*, and *Mammillària* will not throw out roots from cuttings till they have formed their woody axis; while, on the other hand, *Opuntia* and *Epiphýllum*, the young shoots of which are analogous to leaves, throw out roots from all parts of their surface. In gathering *Cacti* in their native habitats, the collector too often pulls them up by main force; in consequence of which, "the fibres which connect the central woody column with the succulent part of the plant, are broken, and the death of the plant ensues.

"During last summer, a fine collection was brought over from Mexico by a Frenchman, who lost some splendid specimens through his ignorance of this connexion of the central column with the plant. Mr. Harris bought some of the best of the dead specimens for his cabinet, and very luckily I got seeds out of all of them, and thus preserved them to the country; the seedlings under my care exceed ten thousand in number, from this importation alone. In raising young seedlings, sow the seeds in pure sand, keep them constantly moist, and transplant them, as soon as you can get hold of them, in sand well drained; give as much heat and moisture as your means will allow, and keep up this stimulus till they have begun to form their woody centre, when they must be more sparingly watered. As a means of extending the cultivation of succulents in general, the hybridist should exercise his art. The *Mesembryanthema* might be crossed till they would vie with the *Cinerariæ*, and the *Aloes* till they surpass the *Gesneriæ*."

We agree with Mr. M'Intosh, that it is impossible sufficiently to

"Commend Mr. Harris for possessing himself of these splendid accessions to the *Cacti* already known, or Mr. Beaton for his zeal and intelligence displayed in obtaining the seeds from many of the dead species of the melon-shaped kinds. The seeds of this are mostly embedded in a soft downy moss, which is thrown up from their top, even long after they are dead, and may also be discovered by cutting the plants transversely across; but, so far as we know, this is a discovery to the credit of which Mr. Harris and his gardener are alone entitled. Mr. Harris has in his herbarium one species, *Cereus*

sessilis, measuring three feet in circumference, and by far the finest specimen ever brought to Europe, from which Mr. Beaton originated above one hundred seedlings by the above means."

*Orchidææ*. On the culture of this tribe we have the following remarks :—

"Mr. Cooper of Wentworth, one of the most successful cultivators of this tribe, and one of the longest standing, differs from most other growers in respect to humidity, giving his plants no more than it is usual to give the general collection of stove plants amongst which they grow. A more successful cultivator than Mr. Cooper is nowhere to be found, nor one more liberal in affording information to those who desire it. His specimens of *Orchidææ* are truly magnificent, and some of them must be very old."

For every different kind of plant-house, a select list of plants is given; each name being accompanied with the time of flowering, the colour of the flower, the soil which the plant prefers, or in which it is generally cultivated, and the mode of propagation. On the whole, *The Green-house, Hot-house, and Stove* will prove a very useful book, both to the gardener and the amateur. For the latter it is more particularly adapted, from its numerous and beautiful coloured vignettes.

---

ART. II. *The Entomologist's Text-Book: an Introduction to the Natural History, Structure, Physiology, and Classification of Insects, including the Crustacea and Arachnida.* By J. O. Westwood, F.L.S., &c. 12mo, pp. 432, plates and numerous woodcuts. London, 1838. 8s. 6d. coloured, and 6s. 6d. plain.

THIS is a republication of a series of articles which appeared in the *British Cyclopædia of Natural History*, a work recently completed in three thick volumes royal 8vo. The object of the articles in the *British Cyclopædia*, and in this little volume, is, to "convey the modern elements of the Science of Entomology in as popular a form as possible," and at the same time in such a manner as to extend the leading principles of philosophical zoology.

"To make the present volume more acceptable to the general reader, several plates of insects have been added, not contained in the *British Cyclopædia*, and which, together with the very numerous wood illustrations, will render the subject more generally intelligible than though double the space had been devoted to mere descriptions. These figures, together with those in the body of the book, are from my own pencil, being in almost every instance original."

The work consists of an Introduction in six chapters, and we think we cannot do better, either for the author, or the reader who wishes to form an opinion as to whether the work is worth purchasing, than to give a short analysis of these chapters.

The Introduction, which occupies seventy-five pages, contains:—

"*Entomology* defined. Extent of subject. Variety of habits. Grounds of superiority. Wisdom of creation in insects especially shown,

“*Benefits and Injuries from Insects.* Insects used as food, &c. Use of insects in the general economy of nature. Obnoxious powers of insects. Plague of flies. Musquito harvest bug. Insects attacking man, furniture, provisions, growing crops, and trees. Remedies against insects.

“*Modes of Research.* Amateur collector. Collecting apparatus. Ravages of Anthreni. Nomenclaturist. Generalised views of entomology requisite. Investigation of the names of insects. Out-door entomologist, and observer of nature. Advantages of studying from the life. Structure dependent upon habits. Character of the true naturalist.

“*Relations of Insects.* Affinity and analogy. Instances of these relations. Proof of a system. Difficulties of the natural system. Number of insect species.

“*Classification and Nomenclature of Insects.* Uses of nomenclature. Series of nature. Constancy of species. Varieties. Specific names. Generic names. Rise of entomological science. Aristotle and the ancients. Revival of letters. Redi, Swammerdam, &c. Linnæus, Fabricius, Latreille. Nature of modern researches. British authors. Entomological societies.

“Chap. I. *On the Extent and Application of the term Insect.* Leading characters. Linnæan sub-kingdom retained. Division into classes. p. 76. to 79.

“Chap. II. Class I. *Crustacea.* History. Relations. Characters. Typical organisation. Nomenclature of organs. Senses. Moulting. Metamorphoses. Distribution into orders. Orders I. to VIII., with their sub-orders described. p. 80. to 122.

Chap. III. Class II. *Arachnida.* History. Character. Senses. Circulation. Classification. Order I. *Dimerosomata.* Webs of spiders. Reputed bird-killing spiders. *Tarantula.* Orders II. to V. described. p. 125. to 148.

“Chap. IV. Class III. *Ametabola.* History. Arrangement. Orders I. to IV. described. p. 150. to 159.

“Chap. V. Class IV. *Ptilota, or Winged Insects.* Characters. p. 163.

“Sect. I. On the principles which regulate the metamorphoses of insects. Views of Swammerdam, Herold, and Kirby. Ditto of Virey. p. 164. to 166.

“Sect. II. The peculiarities exhibited by insects in their passage to the perfect state. Various stages of development. p. 169. to 170.

“Subsect. I. The egg. Eggs deposited in nests. Number and form of eggs. Instinct of female in providing for, and protecting her young. p. 171. to 177.

“Subsect. II. The larva. Uniformity of structure. Monomorphous larvæ. Heteromorphous larvæ. Head of larva and its appendages. Other segments of larvæ. Analogies of larvæ. Voracity of larvæ. Colours and growth of larvæ. p. 179. to 192.

“Subsect. III. The pupa. Varieties of the pupa. Latreille's arrangement from metamorphoses. Newman's ditto. Observations thereon. Metamorphosis inchoata. Metamorphosis dimidiata. Metamorphosis perfecta. Chrysalides. Segments of pupæ. Arrangement of limbs in pupæ. Duration of pupa state. Cocoons. Cocoon of silkworm, &c. Escape of imago from pupa. Anomalous deviations. p. 194. to 224.

“Sect. III. The general structure of insects as especially exhibited in their perfect state. p. 225.

“Subsect. I. External anatomy. Segments of the body. A. The head. Clypeus. Head organs. Composite eyes. Ocelli. Antennæ. Mouth. Varieties of mouth. Labrum. Mandibles. Maxillæ. Labium and mentum. B. The thorax. Its division into three segments. Upper and under surface. Prothorax. Mesothorax. Metathorax. Wings. (a) Markings of wings. Membranaceous wings. (b) Tegmina. (c) Hemelytra. (d) Elytra. (e) Hemelytra. (e) Halteres. (f) Pseudhalteres. Legs. C. The abdomen. p. 225. to 289.

“Subsect. II. *Internal Anatomy.* A. The nervous system. Want of sense of pain in insects. Senses of insects. (a) Sense of sight. (b) Sense of hearing.

(c) Sense of smell. (d) Sense of taste. (e) Sense of touch. B. The digestive system. c. The circulating system. D. The respiratory system. E. The muscular system. F. The generative system. p. 294. to 318.

Sect. iv. Physiology and instinct of insects. Instinct. Instinct for perpetuation of species. Instinct for self-preservation. Modes of defence and attack. p. 318. to 324.

" Sect. v. Classification of Insects. Linnæan arrangement. Other arrangements. Latreille's last arrangement. p. 319. to 332.

" Chap. vi. *Illustrations of the Order of Ptilota*. Order I. Coleoptera. Characters. Habits, &c. Latreille's arrangement. Orders II. to XII. treated of. p. 335. to 421.

" Alphabetical list of the chief entomological writers. Anatomical index. p. 423. to 431.

List of figures of insects given in this work (including the dissections), arranged according to the preceding classification. (The number figured exceed 120.)

Strongly impressed with the importance of the study of insects to gardeners, and well knowing that the great majority of them know so very little of the subject, as not even to have an idea of how it is treated of in books, we have no doubt of the usefulness of giving the contents of Mr. Westwood's work so much in detail. By glancing over these contents, the reader will see the great extent of the subject, and form some idea of the interesting topics brought forward in the course of its discussion; and the result we would wish to be, a strong desire on his part to peruse the work.

---

ART. III. *An Introduction to the modern Classification of Insects; founded on the Natural Habits and corresponding Organisation of the different Families.* By J. O. Westwood, F.L.S., &c. Svo. Vol. I. pp. 462., plates and numerous woodcuts. To be completed in Two Volumes. London, 1839.

IN order that our readers may be able to ascertain the difference between this work and the *Entomologist's Text-Book*, by the same author, it will be requisite that we quote at some length from the preface.

" The majority of entomological works which have appeared during the last quarter of a century, and which have not only given so great an impulse to the science, but have also imparted to it a philosophical character, of which it was previously destitute, may be described as exhibiting either generalised views of the subject, or of elaborate technical details of the genera and species of insects.

" Thus, whilst the delightful *Introduction to Entomology* of Messrs. Kirby and Spence, followed by Burmeister's *Manual*, and, at more humble distances, by the *Insect Architecture, Transformations, and Miscellanies*, the *Grammar of Entomology* by Newman, and my *Entomologist's Text-Book*, have made us acquainted with the general details of insect habits and structure; the *Illustrations and Descriptions of the Genera of British Insects* of Curtis, the *Illustrations of British Entomology* of Stephens, the *Essay on the Fossorial Hymenoptera* of Shuckard, the *Lepidoptera Britannica* of Haworth, &c., have led us to the investigation of the minute details of generic and specific

distinctions. The nature of these works necessarily rendered them essentially different in the information they conveyed; indeed, owing to the greater number of organs possessed by insects over the higher animals, and the consequently great modifications to which they are subjected in the different groups, in order to fit them for performing their various functions, it must be evident, that the former class of works, unless extended to a great number of volumes, must necessarily exclude the description of genera and species; whilst the immense number of insect species in like manner prevented the latter class of works from entering into detailed accounts of habits and structure, or enquiries into the relations of the different groups. Thus the student was led at once from the *general views* he had gained of the subject, to the minute technical details of *genera and species*, there being no work which he could take up to serve as a guide to the development of the principles of modern classification, in the distribution of the *orders and families*. For years this deficiency has strikingly manifested itself to me, and it is long since I announced my present undertaking, in which I had proposed to myself to show the application of the modern views, which have been entertained relative to the natural relations of animals, in the arrangement of the entire groups of winged insects; illustrating the subject by details of the natural habits, transformations, and structure of the different families." (p. iv.)

After showing that the object of the classification of Linnæus and his followers was merely to facilitate the mode of arriving at the names, while that of Latreille and his followers is to promote a knowledge of the nature, of insects, and to facilitate their study in masses, Mr. Westwood observes that his great object has been to make his work a fitting sequel to the *Introduction to Entomology* of Messrs. Kirby and Spence; and these eminent naturalists, he informs us, upon being made acquainted with the nature of the *Introduction to the Modern Classification of Insects*, kindly sanctioned his thus styling it. Did not Mr. Westwood already rank so high as he does in the entomological world, this marked countenance of his work by the fathers of the study of entomology in this country would be sufficient to insure it a favourable reception with the public.

To show that the work has not been undertaken merely with a view to profit, we give the concluding paragraph of the preface,

"The numerous figures, with which the work is illustrated, are, in almost every instance, original, and drawn by myself.

"I cannot conclude this preface without alluding to the endless gratification to be derived from the study of this branch of natural history, of which the present work bears such ample testimony.

"For a long series of years, the collection of materials for its completion has been a ceaseless labour of love. Indeed, had it not been thus, it would have been impossible for me to have proceeded in an undertaking, of which the profit, if by great chance there should be any, could not be expected to repay even the cost of books required in it, and from which any fame must necessarily be confined to a very limited circle (*Kirby and Spence, Introd. Pref. vol. i. p. 10.*), and in which the time absorbed in the preparation of the text, and in microscopically dissecting so many minute objects, represented in the woodcuts, has been so great. I have, however, persevered; and, if I shall have succeeded in inducing any of my readers to pursue the science with a higher aim than that of collecting specimens, by investigating the habits, and the corresponding organisation of these animals, with a view to the discovery

of their natural relations and classification, my labours will not have been in vain." (p. vii.)

The contents of the first volume now before us are as follows :

" Observations upon Insects in general. General Structure of Insects. Head. &c. Mouth. Thorax. Abdomen. Internal System. Transformation. Distribution of Insects into Orders. Metamorphotic System. Alary System. Cibarian System. Eclectic System. Representative System." (p. 1. to 26.)

The author next commences with the order of Coleóptera, which occupies the greater part of the volume; and to this order succeed Euplexóptera (the earwigs) and Orthóptera (cockroach, locust, &c.), with which the volume concludes. We are sorry we cannot afford room for a specimen of the work; but this, to those of our readers who have studied Mr. Westwood's articles in this Magazine, is in a great measure unnecessary. That the *Introduction to the modern Classification of Insects* will become a standard work is beyond all doubt; and we trust that, as it becomes known, it will be as generally sought after as the work of Messrs. Kirby and Spence, to be placed by the side of which volumes, Mr. Westwood avows to be the highest object of his ambition.

---

ART. IV. *A Dictionary of Arts, Manufactures, and Mines: containing a clear Description of their Principles and Practice.* By Andrew Ure, M.D., &c. 8vo. Parts II, III. and IV., pp. 121. to 488., numerous woodcuts. London, 1838.

IN our preceding volume, p. 526., we strongly recommended this work to all who could afford to procure it, as a dictionary of reference. In the three parts before us, the articles which more immediately concern the gardener are: Bitumen, or asphaltum, with a view to garden walks, flat roofs of back sheds, lining cisterns, &c. (see Vol. XIV. p. 567.). Bones (as manure). Brick, in which the different kinds of brick are described, and also the different modes of moulding and burning them; but we were rather surprised not to find some account of Bakewell's patent and that of Hitch (see *Architectural Magazine*, vol. ii. p. 93., and our preceding volume, p. 577.). Calorifere of water, in which a short history of the origin of heating by hot water is given. Carbon, in which the quantity afforded by different trees is given; lignum vitæ affording 26 per cent, and the Scotch pine only 16. Carbonic acid, showing the danger of descending into all pits, cellars, wells, or hollow places whatever, in which there is no outlet. Cements. Charcoal, in which is explained, by various diagrams, the methods of charring wood, and preparing charcoal for the market, adopted by the German foresters. Chimney, in which the conditions necessary to a good



draught are shown. "True economy of heat, and salubrity, alike require vivid combustion of the fuel, with a somewhat brisk draught inside of the chimney, and a corresponding abstraction of air from the apartment. Wholesome continuous ventilation, under the ordinary circumstances of dwelling-houses, cannot be secured in any other way." Clay. Cloth binding, in which the author says: "Nothing places in so striking a point of view the superior taste, judgment, and resources of London tradesmen over those of the rest of the world, than the extensive substitution which they have recently made of embossed silks and calicoes for leather in the binding of books. . . . This new style of binding is distinguished, not more for its durability, elegance, and variety, than for economy and despatch. . . . The reduction of price is not the least advantage incident to the new method, amounting to fully 50 per cent upon that with leather." The humblest gardener has a library of some sort, and he will here learn how he may give it a very handsome appearance, and great durability, at half the usual price per volume. Coffee, which most gardeners use more or less, and which Dr. Ure prefers (having tried most of the new modes), when made from the coffee biggin, with a perforated tin plate strainer. "The useful and agreeable matter in coffee is very soluble; it comes off with the first waters of infusion, and needs no boiling." Colza, the rape of France and Belgium. Concrete. Cider. Earths. Evaporation. Expansion. Ferment. Fermentation. Fibre, vegetable or lignine. Filtration, in which different modes of filtering water, both on a large and small scale are described and illustrated by figures. Flame. Flax, in which Bundy's machine, and all the new processes for breaking and preparing, are described in detail. We consider it unnecessary to repeat our commendations of this work.

---

ART. V. *Catalogue of Works on Gardening, Agriculture, Botany, Rural Architecture, &c., lately published, with some Account of those considered the more interesting.*

*HOME; or The Months; a Poem for Domestic Life.* By John Player, Author of "Fancy's Child." 12mo, pp. 174. London, 1838.

This work has been sent us, we suppose, on account of the notices of gardens and plants which it contains under every month, and the object of which is to promote "the union of devotional sentiment with sensibility to the beauties of natural scenery."

*Mental Philosophy: A Popular View of the Nature, Immortality, Phenomena, and Conduct of the Human Mind.* By Robert Mudie. 12mo, pp. 348. London, 1838.

Many of our readers are acquainted with the vigorous, eloquent, and yet lucid style of Mr. Mudie. Circumstances, he says have compelled him to

“attend closely to the subject of the present volume for a number of years; and it has occurred to” him, “that a simple book, embodying some of the more important truths, in a popular form, and without any of the pretence of philosophy, might be readable, and, if readable, useful.” With respect to the subject, “the study of the mind,” he says, “its nature, its capacity, its phenomena, and the full and rational assurance of its immortal duration and eternal happiness or misery, after all the elements of the present body are rendered back to inorganic matter, is one of the most magnificent and important, and at the same time, in its own nature, one of the most easy and inviting departments in the whole field of human knowledge.” (*Pref.*)

## MISCELLANEOUS INTELLIGENCE.

### ART. I. *General Notices.*

*SELF-IMPROVEMENT.*—I think you will be pleased to be informed that the most influential of the tea-dealers, druggists, and drapers, of Birmingham, have, in compliance with the wishes of the young men in their respective employ, agreed to close their shops an hour earlier each evening than formerly, to enable the young men to devote so much more time to mental and (it is not unreasonable to hope) to moral improvement.

Although not immediately connected with gardening, I am persuaded, if you were to dilate on the subject in the *Gardener's Magazine*, it would induce many others to do likewise; and, as you take so deep an interest in, and so much advocate and recommend, self-improvement, I do hope you will not think it too much trouble to insert this.—*M. C. Edgbaston, Nov. 11. 1838.*

There is no class of apprentices or journeymen, who require to have their hours of labour shortened with a view to mental improvement, so much as gardeners; but such an amelioration can only originate with the masters and the proprietors. We have no doubt that, with the progress of things, and, more especially, with the progress of the cultivation of benevolence and other social feelings among the higher classes, so desirable a result will be obtained. The masters and proprietors, in the end, would feel the beneficial influence of such a concession, more than even the apprentices or journeymen, by the superiority of the productions which their gardens would afford, and the higher degree of order and keeping, and the superior taste, which their gardens would display.—*Cond.*

*Registering Thermometers.*—It would be well to recommend registering thermometers to be universally adopted where journals of the temperature are kept, for then just comparisons could be drawn between those of any two places. Such is not the case when one observes at different stated hours, say 8 A. M., and another at 9. Besides, a registering thermometer gives the correct extremes of maximum and minimum; and, I believe, the mean of these is the surest mode of obtaining the true mean temperature that could be generally adopted.—*R. T. Nov. 7. 1838.*

*Growing Plants under Glass Cases without changing the Air or Water.*—The principle upon which ferns and other plants are grown by Mr. Ward may briefly be stated to be, the imitation, and preservation for indefinite periods, of the natural condition of the plants, free from disturbing causes; and it is applicable to the whole of the vegetable kingdom where such conditions can be imitated. In this climate of ours, there are two sets of plants which are difficult to be managed: 1st, Those which in their native situations enjoy nearly double the quantity of light that we can give them, as the Cape *Protea*, &c.; and 2d, Those, as the inhabitants of the arctic regions, which during three fourths of their existence are in a state of absolute rest.—*W. S. October 5. 1838.*

*Insufficiency of Parchment Labels.*—I much wish to call the attention of your readers, particularly those who are nurserymen, to a point in which they are especially concerned. I allude to the too common practice of sending out trees, shrubs, and herbaceous plants, labelled merely by attaching to them the name written on a *slip of parchment*. A more unsuitable substance for bearing exposure to weather can hardly be imagined; and, as it may not always be convenient for the purchaser to attach more durable tallies immediately on receiving the plants, it may often happen that the delay of a day or two causes great inconvenience and confusion. To give a case in point: I received lately from Lancashire a collection of particularly choice gooseberry trees. As they arrived at the moment of my leaving home for a week, I could not then attend to them. On my return, seeing they had the objectionable parchment labels, I proceeded to give them strong wooden ones; but judge of my mortification



at finding that, from the occurrence of several wet days (and, I think, also from the attacks of slugs), many of the names were illegible. Indeed, in one case the label had altogether rotted, or been devoured by the slugs, which appear to find the wet glutinous parchment a particularly nice morsel. The most common slight wooden labels cut with a pocket knife from laths, or any odd bits of deal board can be made by hundreds on a wet day; and if a little white lead is rubbed on with the finger *at the time the label is wanted*, and the name written with a good black lead pencil, it will certainly last a year at least. Of course it would be better if the wood were Kyanised, especially for those required to be stuck in the ground or in pots. *Fig. 10.* is the form I attach to trees and shrubs, and *fig. 11.* that which I use for plants in pots. I am sorry to see the parchment labels used by some of the most eminent nurserymen in the neighbourhood of London. Surely, they would not find the wooden tallies much, if any, more expensive than parchment ones; and I am sure they would give much more satisfaction to their customers.

While annoyed with my recent disappointment, I was delighted at receiving from an eminent Scottish nursery, a parcel consisting chiefly of small shrubs for the American borders; in which (even down to the little *Rubus arcticus*) a wooden tally was attached to each plant. Perhaps, a word of advice from you, in some future Number of the Magazine, may call a little attention to the subject. The figures given above must be so well known to every one that they require no description.—*W. C. Nov. 10. 1838.*

*Application of Coal Tar to Fruit Trees.*—Much has been said respecting the application of coal tar to fruit trees. A respectable neighbour of mine applied it to the stems of young apple trees, all of which were killed thereby.—*W. G. Hereford, Nov. 1838.*

*Epilobium hirsutum.*—W. Taylor, F.L.S., finds that the down of the seeds of this plant, which, when the pods are mature, is found in considerable quantities, are useful for stuffing pillows, cushions, &c.; and may also be spun into thread, with or without an admixture of cotton.—*W. T. Nov., 1838.*

*Verbena Teucrioides*, one of the most ornamental species of the genus that has yet been discovered, and which is so beautifully figured in Paxton's *Magazine of Botany*, and in the *Botanical Register* for December, is one of the twenty-four species described by Sir W. J. Hooker, in his very interesting work, the *Botanical Miscellany*; and of which twenty-four species only three or four have been introduced. If these three or four have so enriched our gardens as to form a new and striking feature in them (we allude more particularly to *V. chamædrifolia* and its varieties), what may we not expect to be the result, when all those described by Dr. Hooker are introduced! Let the reader only peruse Dr. Hooker's descriptions in the *Miscellany*. Speaking of this work,

we cannot help expressing our surprise that it should not be more common in the library of the general reader, as well as of the botanist. While the definitions are strictly scientific, the descriptive and historical matter is most interesting and entertaining, the plates are beautifully engraved, and the entire work, as we stated when reviewing it in a former volume, is remarkably cheap.—*Cond.*

---

## ART. II. Foreign Notices.

### NORTH AMERICA.

*BOTANIC Nurseries, New Burgh, New York, Nov. 21. 1838.*—I have just received the last Numbers of the *Arboretum Britannicum*, and hardly know how to express my admiration of its completeness and magnificence, as a history of the trees and shrubs of temperate climates. I only regret that the high price at which so costly a work must be sold will prevent its having that general circulation here, and that deserved popularity, which your *Encyclopædias* have found among us. Your *Encyclopædias of Gardening* and of *Agriculture*, are not only the standard works here, but they are almost exclusively the works found among our amateurs and better class of farmers and proprietors. The *Encyclopædia of Cottage, Farm, and Villa Architecture*, although rather too elaborate to suit our popular taste, has already had a very visible effect upon the taste for rural architecture in the United States: and although we build up many edifices that set criticism at defiance, yet a wonderful progress and improvement in architecture has taken place within a few years past; much more, doubtless, than would be brought about in Europe in half a century; and our citizens and landholders only require good specimens, plans, and models, to adopt them at once, as we have no national or ancient prejudices of any sort to combat.

The facility with which we raise good fruit in the open air, in the Middle States, gives a great spur to the planting of fine fruits, and our nurseries contain nearly all the very choicest varieties cultivated at present with you: while such is the luxuriance of the soil, and so favourable is the climate, that numbers of fine seedling varieties spring up almost spontaneously. Some of the old fruits, which Mr. Knight and others of your best European physiologists considered nearly extinct and degenerate, bear and thrive in the Middle States yet, with all their primitive vigour. The *Magazine of Horticulture*, edited by Harvey at Boston, is slowly, though surely, labouring for the good of the cause among us; and, from the report of our horticultural exhibitions therein published, you may gather some idea of the efforts of our principal amateurs. In pretty villas in a high state of keeping, a fondness for rare plants, and forcing the better fruits, Boston is half a century in advance of her sister cities. Philadelphia still holds the palm for fine exotic collections, and a general green-house commercial business. New York is so purely a business emporium, that in its pell-mell few find time for the indulgence of a taste for gardening: but some beautiful conservatories and suburban gardens have recently been erected in Brooklyn.

Judge Buel's excellent monthly paper, the *Cultivator*, is working wonders among our agricultural population, which is sadly in need of enlightening. Its correspondents, who are numerous, lay before its readers the practical results of their operations, carefully conducted in different parts of the Union; and the editorial columns are filled with matter evincing the sound sense and practical science of the conductor. With a circulation of 20,000, including every state and territory of the Union, you may conceive of the influence it wields, and the good results which it may bring about.

The silk culture is progressing also with a zeal and assiduity which characterise all the enterprises undertaken among us. Several of the states have offered large bounties for its production; and our ingenious Yankees are

inventing reels, and other pieces of machinery, which will fairly counter-balance the disadvantage with which we enter into competition with the thickly settled districts of Europe. An enormous speculation has been carried on in the *Morus multicaulis* the present season; trees having been sold as high as 3 cents a bud, or 1 to 3 dollars per tree. This, which gives a profit of about 900 per cent to the grower, is, of course, only a temporary state of things, as millions will be raised next season; but I quote it as an example of the wildness into which enterprise often runs among us.

A most complete and thoroughly scientific work on our North American botany\* is in progress of publication, the first two numbers having been issued. Professors Torrey and Gray are the able and distinguished authors; and the performance will tend greatly to increase their reputation as accurate botanical savans.—*A. J. Downing.*

---

### ART. III. Domestic Notices.

#### ENGLAND.

*NEW Ligneous Plants* raised in the Birmingham Botanic Garden, in the year 1838. *A'lnus barbata* and *subcordata* *Mey.*, *Rhamnus Pulassii* *Fisch. et Mey.*, *R. Wicklii*, *R. opulifolius* *Fisch. et Mey.*, *Ribes opulifolium* *Hort.* All these shrubs are natives of Russia.—*D. C. Birmingham, Nov. 1838.*

*A'lnus cordata*.—Last week I was staying at Britwell House (Mr. Miller's, M.P.). The *A'lnus cordifolia* which I mentioned formerly to you was really splendid, retaining all its glossy leaves like an evergreen, when the surrounding trees were almost all stripped. This circumstance, and its beautifully symmetrical form, render it very desirable for planting. It is, I think, not less than 60 ft. high. Can it have attained this size since 1820, the year of its introduction, according to Sweet? Contrary to the habit of most of its genus, it appears to thrive well away from water, the soil at Britwell being dry and gravelly.—*W. Christy, Jun. Clapham Road, Nov. 9. 1838.*

*Aristolochia trilobata* is now flowering with me for the first time. Its flowers are not nearly so large as those of some of the genus, and are of a fine deep brown colour; but the most remarkable peculiarity in them is a most singular tail-like appendage proceeding from the centre of the lip, and hanging down from it. I measured one, a few days since, 16 in. in length, while the flowers seldom exceed 2 in. On the whole, it is a plant I think well worth growing, especially as it flowers when quite small, and does not take up so much room in the house as is usually required for the climbing species of the genus. My plant was turned out (only a few inches high) not six months ago, and it began to flower immediately on reaching the glass. I have never seen the species before receiving this individual from a collection in Lancashire. Sweet, however, in his *Hortus Britannicus*, records it as introduced in 1775. He does not refer to any figure of it, from which I suppose none existed, at least in English works, when his book was printed in 1830. It is most readily propagated, as it sends out long runners from the base of the stem, which root on the surface of the bed.—*W. Christy, Jun. Clapham Road, Nov. 9. 1838.*

---

\* A Flora of North America, containing abridged descriptions of all the known indigenous and naturalised plants, growing north of Mexico, arranged according to the natural system. By John Torrey and Asa Gray. Svo. Vol. I. Part I., pp. 184. Carey and Hart, Philadelphia, 1838.

This is a work which every European botanist will undoubtedly possess; and if, as we have no doubt will be the case, the habitats of the plants are properly given, it ought to be in the hands of every nurseryman. Our copy has not yet come to hand; but, as soon as it does, we shall give our opinion of it.—*Cond.*

This species is figured in the second volume of Dr. Lindley's *Ladies' Botany*, to illustrate the Birthwort tribe, under the name of *Aristolochia trilobata*; it is also figured in Paxton's *Magazine of Botany*, vol. iii. p. 2. — *Cond.*

#### SCOTLAND.

*Mr. James M'Donald*, who has been head gardener in Dalkeith Park for nearly half a century (during which he has possessed no small share of the respect and confidence of three generations of the noble house of Buccleuch, as well as the esteem of a wide circle of friends and pupils, many of whom, under the good effects of his training, have risen to high distinction in their profession in all parts of the kingdom), having now, in a singularly green old age, retired with honour from the situation he has so long filled, was entertained by a number of his friends at a public dinner at the Cross Keys Inn, Dalkeith, and presented by them with a very handsome silver pitcher, with slider, both richly embossed, in testimony of their high opinion of his professional eminence and private worth. The chair was taken by Mr. Scott Moncrieff, who stated that he might be considered in some measure as representing the Duke of Buccleuch, for His Grace, before leaving Dalkeith, had expressed much satisfaction on being told of this mark of respect about to be paid to Mr. M'Donald, and, in token of his wish to do honour to the occasion, had ordered a liberal supply of venison and other game to be sent to the entertainment. The chairman, with Mr. M'Donald on his right hand, was supported on the left by Dr. Neill, well known as a distinguished horticulturist and botanist, whose presence sufficiently indicated the estimation in which Mr. M'Donald was held in that department of science; and Mr. W. Ballantyne, of the Dalkeith Nurseries, acted as croupier. The Rev. Mr. Robertson, of Dalkeith, and the Rev. Mr. Adamson, of Newton, officiated as chaplains. Besides most of the leading inhabitants of Dalkeith, many gentlemen attended from considerable distances, including the Messrs. M'Nab, from the Royal Botanic and Horticultural Gardens, and several of the principal nurserymen of Edinburgh. In the course of the evening, the healths of their worthy veteran guest, Mr. M'Donald, and of the several members of the noble family, with which he had been so long connected, were received with the utmost enthusiasm; and it may truly be said, that among the many festive meetings recorded, there have been few where more kindly feeling has been displayed, and more enjoyment experienced, than at this. — *R. S. M. (Edinburgh Evening Courier, Nov. 24. 1838.)*

#### IRELAND.

*Newton-Stuart, Co. Tyrone, June 10. 1838.* — In answer to your request, as I am now located in this neighbourhood, I should be happy to give you any information in my power, respecting gardens and gardening in these parts, were it possible for me to write anything on the subject deserving notice. The truth is, gardening is an art neither known nor practised in the north-west district of Ulster; nay, I might perhaps say, with very few exceptions in any part of the province. There being no gardens, it is superfluous to add, that gardeners are not encouraged, and, in fact, do not exist. That there are a species of handy labourers, who possess the knowledge necessary to enable them to cultivate the few indispensable culinary vegetables which a landed proprietor requires, I do not mean to deny; but one of these, fairly entitled to the appellation of gardener, I have not had the good fortune to meet with, since I last saw our common friend Mr. Ellice, of the Palace Gardens, Armagh. — *M.*

*Phyllocladis, and other Australian Plants.* — In answer to your request in the October Number of the *Gardener's Magazine*, respecting the *Phyllocladis* and other Australian plants we have lately been enabled to add to our collection, through the kindness of Dr. Birnie of Belfast, I find the best details I can

give at present are what I received verbally from that gentleman. The plants which came in the package were *Phyllócladis rhomboidális* (see *Arb. Brit.*, vol. iv., p. 2102.), *Araucària excélsa*, *Telòpea speciosíssima*, *Doryánthes excélsa*, *Hibíscus Pattersonii*, *Cælothámnus clavata*, *Phórmium ténax*, and *Acàcia* sp. With exception of the *Phyllócladis*, these plants were nearly eight months on their passage, the box having been opened two months after the ship sailed from Sydney, and the *Phyllócladis* added. Dr. Birnie states he found them growing in Recherche Bay, D'Entrecasteaux Channel, Van Diemen's Land, where they attained a height of from 12 ft. to 14 ft.; appearing to prefer a moist heathy soil, inclining to swampy. It being the winter season, and the ground all covered with frost and snow, Dr. Birnie was prevented from extending his journey through the woods, but was told that they attained a much larger size in the interior. Those we received were from 9 in. to 18 in. high, and very sickly when they arrived; and only two out of five have survived. I am, however, happy to state they are now in a promising condition, and are putting out young shoots over the whole plants.

The araucarias were in perfect health when they arrived; and, though the other plants were sickly, they have all recovered. The above is all the information I can give at present, but I shall feel happy to communicate the results at a future period, along with other details respecting our success in endeavouring to naturalise other plants from the same countries. — *Daniel Ferguson, Curator. Belfast Botanic Garden, Nov. 12. 1838.*

#### ART. IV. *Retrospective Criticism.*

*RHUBARB Jam.* (Vol. XIV. p. 541.) — In the last Number of the *Gardener's Magazine* (p. 541.), we are favoured with a fresh illustration of the stale subject rhubarb jam, which we thought had gone quietly to rest; but opinions run counter, and the *candour* of your correspondent has laid us under the necessity of showing the credence of his statement, and the degree of consistency on which his pretensions to the discovery are founded. I am cognisant of the facts, and will, with your permission, lay them before your readers.

It is true that Mr. Johnson sent me a jar of rhubarb jam in the summer of 1836, also a verbal statement of the manner in which it was prepared. It was the first sample of the kind I had seen, and I requested he would have the goodness to send you the particulars for the *Gardener's Magazine*. It was his wish that so desirable an article should have publicity; but he had some intentions that summer to visit London, and meant to present you with a sample.

Mr. J. M'Nab paid us a visit in the autumn of 1837, and the "frightful composition of green rhubarb and brown sugar" which he experimented on, was none of *Mr. Johnson's*, but *ours*. He was informed of this fact at the time, though he found it convenient to state the contrary; and, as we see no particular reason why Mr. Johnson should monopolise the credit which is due to us for that *delightful specimen*, we invite any of your readers who take an interest in such matters to a fair trial of the ingredients; the result will not disappoint them.

In Vol. XIII. p. 460., Mr. M'Nab has the "sole merit of introducing this novelty." Mr. Johnson allows (Vol. XIV. p. 395.) "that he might have the credit of introducing the jam into Scotland, but that the suggestion which led to his making the trial was *his*, for *I had informed him*;" a *positive fact on the part of Mr. Johnson*, though Mr. J. M'Nab declares he never heard of any thing of the kind, till the blushing virtues of his tart demonstration of 1837 furnished him a clue to the invention; but let it not be lost sight of, that he is silent as the grave respecting his visit to this place on his return from the Sheffield exhibition in the autumn of 1836. Why, let us ask, could he not favour the public with a portion of his gleanings on that occasion? It was inconvenient to hint at the subject, and we appreciate the *motive*; for it was on

that visit I informed him of the sample of rhubarb jam which was sent me that summer, and of the manner in which (I was told) it was prepared. Will he deny this fact, of which he made a memorandum on the spot? I refer him to his note-book; and, if farther proof be necessary, *I will verify my statement on oath.*

Mr. Johnson's receipt is simply this: To one pound of rhubarb stalks, cut as if for a tart, add one pound of *lump* or *brown sugar*, boil till the ingredients are well blended, and acquire the proper consistence. We need not trouble your readers with the details necessary in making jelly; but may remark that ginger (not ground) and candied lemon, boiled in the jelly or jam, is a decided improvement. Jelly of a superior quality has been made in this neighbourhood in this manner. Buck's rhubarb has the preference in point of colour, but in no other quality that we are aware of. — *Alexander Campbell. Botanic Garden, Manchester, Nov. 19. 1838.*

#### ART. V. *Queries and Answers.*

*NAMES of the different Species of Corræa, (Vol. XIV. p. 542.)*—Your correspondent S., if he had taken the trouble to refer to your *Encyclopædia of Plants*, or your *Hortus Britannicus*, could have ascertained the names of the different species of *Corræa*. However, for his information, I will enumerate them: *álba*, *virens*, *speciosa*, *rufa*, and *pulchélla*; I believe there is a new one, recently introduced, but I have not heard its name, neither have I seen any description of it. With respect to *C. rufa*, it was introduced many years ago, and, I believe, lost. It has recently been received again, either from the Continent or New South Wales. The foliage is good, and the flower is green, but very inferior to *virens*, not being so large, or so bright a green. It is to be purchased at the nurseries for about ten or fifteen shillings. *Corræa Milnerii* is a seedling variety; it is not much known, but may be purchased at Groom's in the Walworth Road, and at Lee's, Hammersmith. There is also a plant at Mrs. Lawrence's, and another at Worton Lodge. I believe it is not to be bought under two guineas. It is scarcely probable that there are any other seedling varieties; the different species seldom producing seed. — *Amateur. Hackney, Nov. 10. 1838.*

#### ART. VI. *Proceedings of the Horticultural Society of London.*

*JUNE 5. 1838.*—Extracts from the Meteorological Journal kept at the garden during the year 1837. The following were the monthly results, as regards some of the more striking phenomena of the season:—

	Mean Pressure, in inches.	Mean Tem. Fahr.	Max. Tem. in shade.	Min. Temper.	Amount of Rain, in inches.
January - -	29·956	38·58°	50·90°	12·20°	3·03
February - -	29·969	41·20	55·40	26·60	2·01
March - - -	29·979	37·94	49·46	19·40	0·54
April - - -	29·811	41·95	63·50	23	1·13
May - - - -	29·957	49·62	74·30	30·20	1·07
June - - - -	30·009	60·08	80·60	35·60	1·31
July - - - -	29·969	63·16	83·30	37·40	1·78
August - - -	30·002	62·53	86·90	39·20	3·04
September -	29·894	55·68	72·50	35·06	0·91
October - - -	30·119	50	73·40	27·14	2·39
November - -	29·861	40·22	55·40	22·10	1·32
December - -	29·964	41·38	54·50	23·90	1·35



It was stated that the mean temperature of 1837, was 48·52° Fahr., while the mean of ten preceding years, as registered at the garden, was 50·62°, and consequently the year 1837 was about 2° colder than usual, notwithstanding the absence of severe weather in January, and the extraordinary mildness of December. The lowness of temperature occurred in the growing part of the season, and more especially in March, April, and May. The season was not only colder, but much drier: for the whole amount of rain was only 19·88 in., which is about 4 in. below the average quantity that falls round London.

Mr. Thompson communicated a memorandum concerning the temperature of the earth for the seven last months of 1837; as indicated by two geothermometers buried in the soil, one a foot and the other 2 ft. below the surface, and compared with a common thermometer suspended in the air 3 ft. above them.

The monthly results are expressed in the following table:—

	Mean Temperature of Earth, indicated by the two Geothermometers.	Mean Temperature of Air indicated by a common Thermometer 3 ft. above ground.
June - - -	59·01°	60·08°
July - - -	64·19	63·16
August - - -	63·38	62·53
September - - -	57·92	55·68
October - - -	53·6	50
November - - -	44·6	40·22
December - - -	42·74	41·38
Mean - - -	55·06	53·29

From the above, it appears that the difference between the terrestrial temperature at the above depths (1 and 2 ft.), and that of the atmosphere near the surface of the earth, is  $1\frac{7}{10}$  Fahr. But as the ground is comparatively warmer than the atmosphere in the autumn, and colder in spring, it may be inferred that the mean temperature of the earth, a little below the surface, agrees very closely with that of the atmosphere, taking the average of the whole year into account. The average of the 1 ft. geothermometer was 55·01°, that of the 2 ft. geothermometer was 55·13°. The difference being only about  $\frac{1}{10}$  of a degree. The highest temperature indicated by the 1 ft. geothermometer was 96°, and by the 2 ft. instrument 66°. This occurred about the 28th of July; but, on the whole, July and August maintained nearly an equal terrestrial temperature. The difference between these months and December was upwards of 20°.

The following objects were exhibited:—From Mrs. Lawrence, F.H.S., a small collection of plants, among which a beautiful specimen of *Pavetta caffra* was conspicuous for its numerous close cymes of snow-white flowers. From George Barker, Esq., F.H.S., a flowering spike of the sweet-scented *Epidendrum primulinum*, a new green-flowered orchidaceous plant which he had introduced from Cuba. From Messrs. Lowe and Co., of Clapton, plants in flower of the rare *Chysis aurea*, the beautiful *Statice arborea*, and *Clematis cærulea*. It was stated by Mr. Lowe that the latter, which is one of the handsomest species of *Clematis* (see *Botanical Register*, vol. xxiii. t. 1955.), proved perfectly hardy during the late winter. From W. Bromley, Esq., F.H.S., a small collection of green-house plants, among which was a flowering specimen of *Banksia speciosa*. From Mr. Dennis, nurseryman, Chelsea, a collection of *Pelargoniums*. From Mr. Dunsford, gardener to Baron Dimsdale, specimens of *Coryanthes speciosa*, an extremely curious orchidaceous plant, and of *Combretum purpureum*. From the

Hon. W. F. Strangways, F.H.S., a collection of cut flowers, and models of baskets used in the garden at Abbotsbury in Dorsetshire, for protecting plants in winter. These models were intended to show how easily plants and shrubs may be protected in the open air, and how the mode of protection may be varied according to circumstances.

*Fig. 12. a.* Semicircular hurdle, to protect plants trained against a wall, especially if newly planted and exposed to a sunny or windy quarter.

*Fig. 12. b* is a double semicircular hurdle, or split cylinder, with loops on each side, forming hinges or clasps. This is useful to put round the stems of young trees, whose branches are too spreading to allow of a circular hurdle being passed over them from above. It is used as a protection against hares and rabbits in a shrubbery.

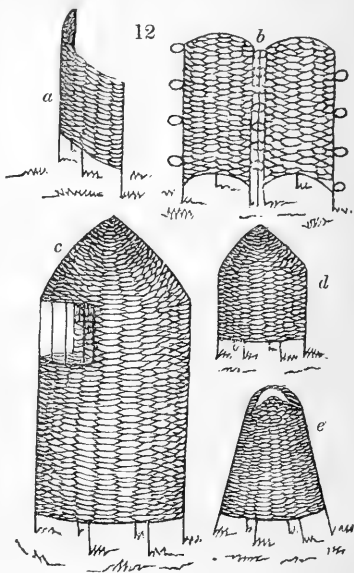
*Fig. 12. c.* Large cylindrical basket, to cover tall shrubs, with a vizor, or window, to be turned towards the sun, or away from the wind, but to admit air. These are chiefly adapted for permanent defences in the winter.

*Fig. 12. d* is the simplest form of basket or circular hurdle, intended to protect low bushes or growing herbaceous plants. It is well adapted for plants coming into flower.

*Fig. 12. e.* Bell-shaped, with a handle. Very convenient for covering plants that shoot early in the year, at night.

These contrivances are particularly adapted for gardens near the sea, or in any windy situation; or for pleasure-grounds not secured against game. They are of common hurdle-work, of hazel and withy, the main stakes being made strong and pointed, so as to be firmly fixed in the earth. Those that are used for winter protection, or for the tenderer plants, may be filled with straw or covered with a mat. They are particularly useful in the spring, as they are easily put on and off, according to the weather, and are more healthy for many plants than a close covering, being permeable to the air. The forms only are represented in the margin; the size and proportions being varied according to the use for which they are intended. Small semiglobular close

chip baskets, not above a foot high, are also used, as shades for delicate alpine plants in sunny or windy weather. From Mr. Glendingning, gardener to the Lord Rolle, F.H.S., six fine Queen Pine-apples. From Messrs. Chandler and Son, a beautiful collection of varieties of *Rhododendron catawbiense*. From the Rev. W. Mansfield, Rectory, Milton Bryant, Bedfordshire, two seedling *Calceolarias*. From Mr. John Lumsden, gardener to Henry Bevan, Esq., F.H.S., a very fine collection of ten shrubby *Calceolarias*; and a plant of the beautiful Brazilian *Manettia cordifolia*, trained in various directions over a treillage fixed to the pot, and covering it so completely as to form a bed of deep rich green, along which the long crimson trumpet-shaped flowers hung in great profusion. From Mr. Myatt of Deptford, stalks of a new kind of *Rhubarb*, called the *Victoria*. It appeared to be a variety of *Rheum hybridum*, of enormous size; the leafstalks were each 2 ft. 8 in. long, and 6 in. in circumference, and twelve of the stalks weighed 46 lb. From Mr. Mountjoy of Ealing, a fine collection of *Heartsease*, *Verbena incisa*, and *Stylidium graminifolium*, with its curious irritable flowers. From Mr. W. P. Ayres, gardener at Chicksands Priory, Bedfordshire, two varieties of Lettuce,



called the Acme American Cabbage, and the Acme Spanish Cos, said to be new and hardy. From Thomas N. Parker, Esq., F.H.S., of Sweeney Hall, near Oswestry, specimens of the Sweeney nonpareil apple. They were in excellent preservation, notwithstanding the lateness of the season, and quite acid enough for kitchen use. They fully proved the claim of this apple to be considered one of the best of the late keepers. From the Society's garden, a collection of hardy and green-house plants, among which were fine specimens of the *Syringa Josikæa*, a very striking species of lilac, found wild a few years since in Transylvania, on the estate of the Countess Josiká, near Sebes in Klausenburg; it differs from the common lilac in having narrower and thicker leaves, and darker flowers, with much less fragrance. *Helichrysum scorpioides D. C.* a pretty half-hardy herbaceous plant, just received from Van Diemen's land, and the brilliant white *Spiræa barbata* (*Hoteia japonica Decaisne*, *Spiræa japonica* of gardeners), were also in this collection.

The following medals were awarded:—The silver Knightian to Mr. John Lumsden for *Calceolarias*; and to George Barker, Esq., for his *Epidendrum primulinum*. The silver Banksian to Mrs. Lawrence, for *Pavetta caffra*; to Mr. Glendinning, for pine-apples; to Messrs. Lowe and Co., for *Clematis azurea*; to Mr. Myatt, for *Victoria rhubarb*; to Messrs. Chandler, for the varieties of *Rhododendron catawbiense*; and to Mr. Mountjoy, for his heartsease.

June 16, 1838.—*Exhibition at the Garden.* The number of visitors upon this occasion was 6405, exclusive of exhibitors. The arrangements remained as before, except that about 500 ft. of tables had been added in one of the long tents, in order to receive large specimens of plants. The method of judging was altered by arranging the duties of the judges under five separate heads, to each of which distinct judges were assigned, and it was found that by this plan the exhibitions submitted to competition could be more particularly examined.

The awards were given in our preceding volume.

June 19, 1838.—*Special General Meeting.* This was convened, conformably to the provisions made by the by-laws, for the purpose of electing a President in the room of Thomas Andrew Knight, Esq., deceased, and for filling up the vacancy thus occasioned in the Council. The chair was taken by H. Moreton Dyer, Esq., Vice-President. The following resolutions put by the Rev. Edwin Prodgers, and seconded by the Secretary, were carried unanimously:—

“That this Meeting deeply deplore the loss the Society has sustained by the death of their late President, Thomas Andrew Knight, Esq., an individual not less distinguished for his private worth, than for his public usefulness, whose memory, from the urbanity of his manners, the kindness of his disposition, his attachment to science generally, and more especially to that branch patronised by this Society, will be long cherished, as his decease is sincerely lamented.”

“That this expression of sympathy and condolence be communicated to his wife and family.”

The Chairman then announced on the part of the Council, that it had been determined to recommend, as the new President of the Society, the Most Noble William Spencer Cavendish, Duke of Devonshire, and as a new member of the Council, Sir Philip de Malpas Grey Egerton, Bart., M.P. At the close of the ballot the office of Scrutineers was undertaken by the Right Hon. W. Sturges Bourne, Sir Oswald Mosley, Bart., and William Harrison, Esq., who reported that the election had unanimously fallen upon His Grace the Duke of Devonshire, as President; and Sir Philip de M. Grey Egerton, Bart., as a new Member of the Council.

June 19, 1838.—*Ordinary Meeting. Exhibited.* From the Honourable Wm. Fox Strangways, F.H.S., a stick of the olive tree which had been killed in the garden at Abbotsbury by the last winter. It was grown at the foot of the terrace at Abbotsbury at a distance from any wall. It had never been covered

in the winter; and was raised from a cutting taken from a green-house plant in 1829 or 30, struck in a pot, then planted out, and the whole of the original cutting which was crooked cut off. So that this stick was a young shoot from the root, not more than seven years' growth, produced entirely in the open air. It measured (the end shoots cut off) 5 ft. in length, 1 ft. round the base. From Thomas Harris, Esq., F.H.S., of Kingsbury, a very extensive and remarkable collection of cactaceous plants. Many of the specimens were aged individuals imported from Mexico, and some of them exhibited in a striking manner the transition from round or spheroidal stems to compressed and sinuous ones. *Opuntia senilis* and several specimens of *Cercus senilis* were present in great perfection; as were some seedlings of the latter, nine months old, which were quite free from the long hoary hairs which give that plant so singular an appearance when old. This collection was accompanied by a small collection of green-house plants, among which were *Diplolæna Dampieri* and *Hoitza mexicana*. From Mr. John Lumsden, gardener to H. Bevan, Esq., F.H.S., a dish of fine elruge nectarines. From Sir C. Lemon, Bart., a dish of lemons ripened at Carclew. From James Bateman, Esq., F.H.S., specimens of the *Epidendrum macrochilum*, and of a new species of that genus, which he proposes to call *Epidendrum alatum*. The latter was accompanied by the following memorandum. "A remarkably fine and distinct new species of *Epidendrum* discovered by Mr. Skinner in the interior of Honduras, and kindly sent to me from thence in the summer of 1837. The habit is exceedingly striking, the leaves being dark green, 2 ft. long, gracefully curved, and placed in twos and threes on the apex of the large oval pseudo-bulbs. It grows very freely, and though now flowering for the first time, and therefore of course with not half the vigour that may be expected from it, produced a spike 3 ft. in height on which forty flowers were in perfection at the same moment. It has continued in beauty for upwards of six weeks, scenting the whole house wherein it grew with one of the most delicate and delightful perfumes imaginable. The gold margin to the lip contributes much to the elegance of its appearance; and its column is furnished with a pair of pseudo-wings which have suggested the name. It will be figured in Part 4. of the *Orchidaceæ of Mexico and Guatemala*." Unfortunately these specimens had been almost destroyed by the carriage from Knypersley. From the Society's garden, a variety of hardy green-house plants, among which was a very remarkable hybrid *Mimulus*, of striking beauty, which had been raised between *M. cardinalis* and *M. roseus*. It possessed the vigorous growth of the former, while its foliage had become more firm, and the flowers were of the colour of *M. roseus* suffused with an admixture of the scarlet of *M. cardinalis*. This plant, called *Mimulus roseo-cardinalis*, had been presented to the Society by Lieut.-Col. Fielding, F.H.S. A Banksian medal was awarded to Mr. Lumsden for his nectarines. It was also stated that a large silver medal would have been assigned to Mr. Harris for the fine collection of cactaceous plants, had that gentleman not requested that they should not be taken into account by the judges.

July 3, 1838.—*Ordinary Meeting.* His Grace the Duke of Devonshire, President, took the chair. The following letter was read from Sir W. E. R. Boughton, Bart., in acknowledgement of the resolution passed at the Special General Meeting on the 19th of June.

"Blenheim Hotel, June 26. 1838.

"My dear Sir, I have received, forwarded to me in London, the resolutions of a Special Meeting of the Horticultural Society of London, communicating their great regret at the death of their late President, to his afflicted widow and family. May I beg the favour of you to convey to the Society the sincere thanks of Mrs. Knight, and of every individual of the family, for this very flattering condolence, which expresses with so much force and feeling the high sense they entertain of his private worth and public services. Mr. Knight's warm attachment to the welfare of the Horticultural Society, and to its

pursuits, has been fully proved by the ardour and constancy with which he applied his very original mind to the objects of the Society, as influenced by the investigation of the laws of nature. From his earliest youth he viewed the prosperity of such an Institution as a subject of much national importance, and he considered that it would exert an influence, as it has done, to a great extent, in spreading amongst the people a knowledge of the true principles of vegetable physiology, of procuring for them an increased supply of food, and of adding largely to the general comforts and happiness of mankind. These were the objects Mr. Knight kept constantly in view, and which the Horticultural Society have so successfully promoted. With every grateful acknowledgement for the honour they have done to his memory, and with my best wishes for their continued prosperity, I remain, my dear Sir, very faithfully yours,

W. E. ROUSE BOUGHTON.

“George Bentham, Esq., &c.”

The following objects were exhibited:—From James Bateman, Esq., F.H.S., beautiful specimens of *Cattleya intermedia*, *Cynoches ventricosum* an epiphyte with a delicious odour, *Dendrobium chrysanthum*, and the rare *Dendrobium secundum*; the last was in a state of very unusual perfection. The *Cynoches* had flowers much larger than usual, the sepals and petals more fleshy, the column terete, and the anther and pollen masses were abortive. It was, however, stated by Mr. Bateman, in a note that accompanied the collection, that the flowers were produced from the same plant as that which yielded the specimen represented in his *Orchidaceæ of Mexico and Guatemala*, and which had previously blossomed five times without exhibiting any disposition to vary. From Messrs. Dart and Sons, 69. Strand, a model of a self-acting ventilator for hot-houses, pits, or any similar places. It worked by the expansion and contraction of a pyrometer formed of a hollow cylinder of zinc, and appeared to be sensible of very small differences in temperature. From the Hon. W. F. Strangways, F.H.S., various cut flowers, among which were beautiful specimens of *Pisum maritimum* wild, from the sea coast of Dorsetshire, and branches of *Pittosporum Tobira* and *Veronica decussata*, which had stood out during the last winter in the open border at Abbotsbury. From Mr. Charles Marshall, gardener to Mrs. Langley of Kingston, specimens of a bean, which was stated to be a fortnight earlier than the common longpod bean, from among a crop of which the seed was saved. From G. H. Ward, Esq., F.H.S., small specimens of a kind of carrot, imported from Thoulouse, and said to measure there from 3 ft. to 3 ft. 6 in. in length. From W. R. Hamilton, Esq., Stanley Grove, Chelsea, a species of *Arum* brought by his son, Mr. W. I. Hamilton, from the banks of the *Mesistus* in Asia Minor, four days journey south of *Cyzicus*. It proved to be *Arum Dracunculus*. From Mr. Mountjoy of Ealing, *Fuchsia fulgens* and *Lophospermum grandiflorum*. From Mr. Myatt of Deptford, specimens of three new varieties of strawberry. From Mr. Hogg of Paddington, six seedling pinks of the present year; and also a collection of Pinks. From R. Harrison, Esq., F.H.S., of Aighburgh near Liverpool, a new species of *Oncidium* (*pulvinatum*) imported from Brazil. It had produced a straggling zigzag panicle, 6 or 7 ft. long, with very much the appearance of *O. divaricatum*, from which it differed in the form of its labellum, and in having a convex villous cushion at the base of that organ. From the Society's garden, a variety of plants in flower.

The following medals were awarded:—The silver Knightian to Richard Harrison, Esq., for *Oncidium pulvinatum*, and to James Bateman, Esq., for *Dendrobium secundum*.

#### ART. VII. Covent Garden Market.

THE market has been regularly, but not abundantly, supplied during the season with all the varieties of vegetables usually expected at this period; the quality of most of the articles decidedly good, with remunerating prices to the growers. Of apples we have had a good average supply, in consequence of a

change in the Customs' duties, by which all the varieties are admitted at an ad valorem duty; hitherto the charge of four shillings per bushel has prevented the admission of the inferior sorts. Some excitement has been attempted by parties interested against this measure, but it certainly never could have been adopted at a better time, as the crops of this country have proved so completely a failure, that, but for such measure, the prices would have been considerably higher, and the consumption materially impeded, as they would have been beyond the reach of the poorer classes, by whom they can now be obtained at a moderate rate; in the meantime, the better sorts can be purchased at such rates only as can be afforded by the richer members of society. Of pears we have had an excellent crop; but few have been imported, and those principally from Guernsey, not being subject to any duty whatever. Oranges are as yet furnished in limited quantities, the season apparently being as late in Portugal and elsewhere as here. Pine-apples, of good size and quality, have been in demand, and realised good prices. Late grapes have been sparingly supplied; but being badly ripened, and of indifferent quality, have not been much enquired after. — *C. G. M., Dec. 15. 1838.*

	From	To	From	To
	£ s. d.	£ s. d.	£ s. d.	£ s. d.
<i>The Cabbage Tribe.</i>				
Cabbage Plants, or Coleworts, per dozen - - -	0 3 0	0 4 0	Small Salads, per punnet -	0 2 0
Savoys, per dozen - - -	0 0 9	0 1 6	Watercress, per doz. small bun.	0 0 6
Brussels Sprouts, per half sieve - - -	0 2 6	0 3 0	<i>Pot and Sweet Herbs.</i>	
Cauliflowers, per dozen - -	0 4 0	0 6 0	Parsley, per half sieve -	0 1 6
Broccoli, per bunch: - - -			Tarragon, dried, per doz. bun.	0 1 6
White - - - - -	0 2 0	0 3 0	Fennel, dried, per doz. bunches	0 1 0
Purple - - - - -	0 1 6	0 2 0	Thyme, per dozen bunches	0 3 0
Cape - - - - -	0 2 0	0 0 0	Sage, per dozen bunches	0 6 0
<i>Tubers and Roots.</i>				
Potatoes { per ton - - -	4 0 0	5 0 0	Mint, dried, per doz. bunches	0 1 0
{ per cwt. - - -	0 4 0	0 5 0	Peppermint, dried, per dozen bunches - - -	0 1 0
{ per bushel - - -	0 2 0	0 2 6	Marjoram, dried, per doz. bun.	0 1 0
Kidney, per bushel - - -	0 2 9	0 3 0	Savory, dried, per doz. bunches	0 1 0
Scotch, per bushel - - -	0 2 6	0 2 9	Basil, dried, per dozen bunches	0 1 3
Jerusalem Artichokes, per half sieve - - -	0 1 6	0 0 0	Rosemary, per dozen bunches	0 6 0
Turnips, White, per bunch - -	0 0 2	0 0 3	Lavender, dried, per doz. bun.	0 2 6
Carrots, per bunch - - -	0 0 4	0 0 6	Tansy, dried, per doz. bun.	0 1 0
Parsneps, per dozen - - -	0 1 0	0 1 3	<i>Edible Fungi and Fuci.</i>	
Red Beet, per dozen - - -	0 1 6	0 2 0	Morels, per pound - - -	0 16 0
Scorzoneria, per bundle - - -	0 1 3	0 1 6	Truffles, per pound:	
Salsify, per bunch - - -	0 1 3	0 1 6	English - - - - -	0 14 0
Horseradish, per bundle - -	0 1 6	0 4 0	Foreign - - - - -	0 14 0
<i>Radishes:</i>				
Red, per dozen hands (24 to 30 each) - - -	0 0 9	0 1 0	<i>Fruits.</i>	
White Turnip, per bunch - -	0 0 2	0 0 0	Apples, Dessert, per bushel:	
<i>The Spinach Tribe.</i>				
Spinach { per sieve - - -	0 2 3	0 2 6	Nonpareils - - - - -	1 0 0
{ per half sieve - - -	0 1 3	0 1 6	Ribston Pippins - - - -	0 10 0
Sorrel, per half sieve - - -	0 1 0	0 1 6	Baking - - - - -	0 4 0
<i>The Onion Tribe.</i>				
Onions: - - - - -			American - - - - -	0 10 0
Old, per bushel - - - - -	0 3 0	0 3 6	French - - - - -	0 3 6
For pickling, per half sieve	0 2 6	0 5 0	Pears, Dessert, per half sieve:	
When green (Ciboules), per bunch - - -	0 0 4	0 0 6	Colmars - - - - -	0 7 0
Leeks, per dozen bunches - -	0 1 0	0 1 6	Chamontelles - - - - -	0 8 0
Garlic, per pound - - - - -	0 0 8	0 0 0	Neillis d'Hivers - - - -	0 6 0
Shallots, per pound - - - - -	0 0 10	0 0 0	Baking - - - - -	0 3 0
<i>Asparagus Plants, Salads, &amp;c.</i>				
Sea-kale, per punnet - - -	0 2 0	0 2 6	Quinces, per half sieve - -	0 5 0
Lettuce, per score: - - -			Cranberries, per gallon - -	0 3 0
Cos - - - - -	0 1 0	0 1 6	Chestnuts, French, per peck	0 4 0
Cabbage - - - - -	0 0 9	0 1 0	Filberts, English, per 100 lbs.	5 0 0
Endive, per score - - - - -	0 1 6	0 2 0	Hazel Nuts, per peck - - -	0 3 0
Celery, per bundle (12 to 15)	0 0 9	0 2 0	Pine-apples, per pound - - -	0 5 0
			Grapes, hot-house, per pound	0 3 0
			Oranges { per dozen - - - -	0 1 0
			{ per hundred - - - - -	0 2 6
			Bitter, per hundred - - - -	0 8 0
			Lemons { per dozen - - - -	0 1 0
			{ per hundred - - - - -	0 6 0
			Sweet Almonds, per pound -	0 3 0
			Nuts, per bushel:	
			Brazil - - - - -	0 14 0
			Spanish - - - - -	0 16 0
			Barcelona - - - - -	1 2 0

THE  
GARDENER'S MAGAZINE,

FEBRUARY, 1839.

---

---

ORIGINAL COMMUNICATIONS.

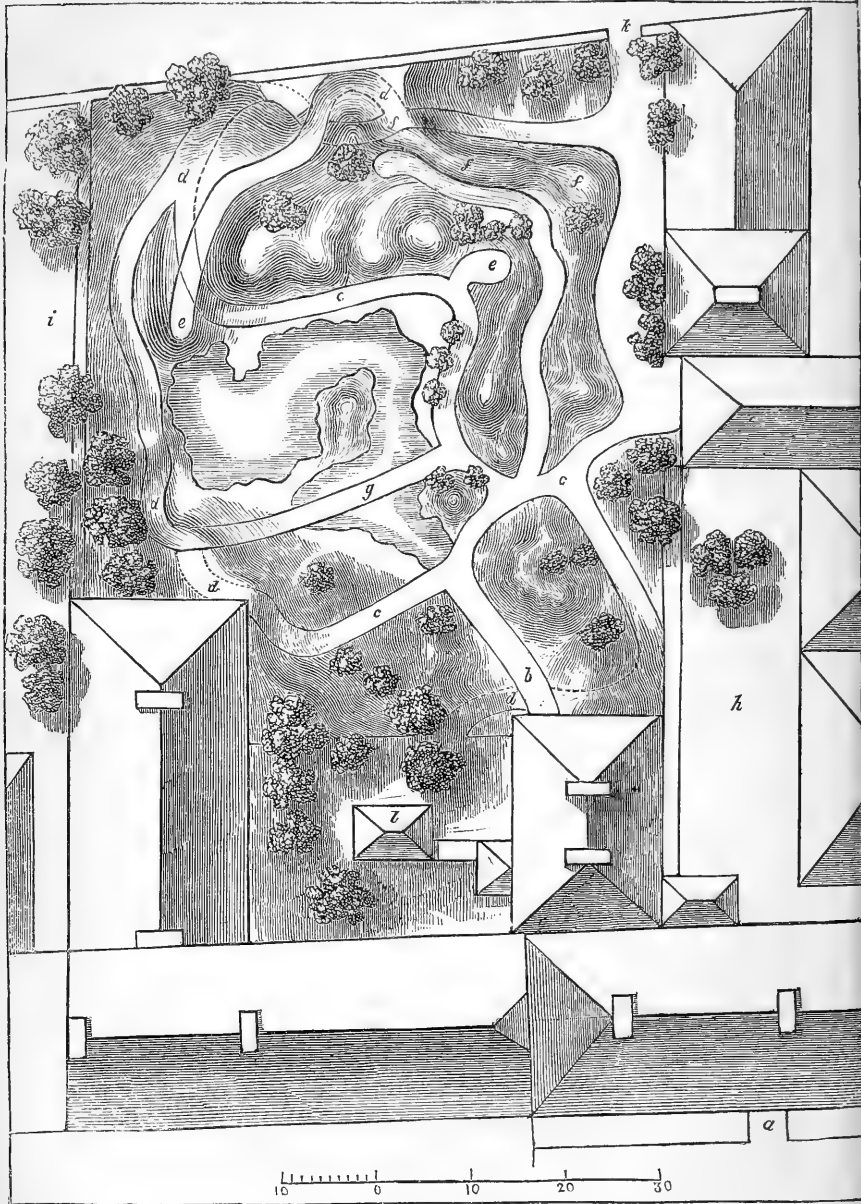
ART. I. *Descriptive Notices of select Suburban Residences, with Remarks on each ; intended to illustrate the Principles and Practice of Landscape-Gardening.* By the CONDUCTOR.

No. 11. THE ROCK GARDEN OF THOMAS MILLIE, ESQ., IN ST. CLAIR-TOWN, NEAR KIRKALDY, FIFESHIRE.

[THE Rock Garden at St. Clairtown, a vertical profile, and two views of which have been kindly sent to us by the proprietor, Thomas Millie, Esq., shows what may be done in the way of garden scenery in a very confined space, surrounded by houses. We have not given a plan of any part of the grounds, except the Rock Garden, because the rest of what is necessary to constitute a comfortable suburban residence may be easily conceived ; and, in this case, the kitchen-garden and fields are so completely detached from the rock garden as to be quite unconnected with them, as far as pictorial effect is concerned.

The vertical profile (*fig. 13.*) shows a piece of water in the middle of ground which rises from it on every side towards the houses, the roofs of which are shown ; and the area is intersected by walks, chiefly open to the day, but partly subterraneous, as indicated by dots in the plan. One walk crosses the piece of water on a bridge ; and, judging from the plan without having seen the premises, the only fault we have to find with it is, that this bridge appears to cross the water in one of the wide parts, while a narrow part is close at hand, which it might have crossed with greater ease. This is not according to nature and reason ; nevertheless, in the reality it may be excusable, and rendered inoffensive to the critical eye, by the rising up of rocks through the water, which may have served in part as piers to the arches of the bridge. We do not, therefore, say that the bridge crossing the lake at a wide part is a fault in reality, but merely that it is a fault in the appearance of the plan. The contrivance of the walks crossing one another is admirable ; and we are informed, by a gentleman who has been in the garden, that the effect is even far beyond what might have been anticipated.

The two views, *fig. 14.* and *fig. 15.*, are engraved from oil



*Rock Garden of Thomas Millie, Esq.*

*a*, Street entrance to the house. *b*, Bridge walk from the drawingroom to the garden. *c, c, c*, Open walks among the rockwork. *d, d, d*, Subterranean walks under the rockwork. *e, e, e*, Seats. *f, f, f*, High rocky screens. *g*, Bridge over the lake. *h*, Court-yard. *i*, Trees which serve to disguise the scenery of the adjoining street gardens. *k*, Door to a back lane, which leads to the kitchen-garden and farm. *l*, Aviary.

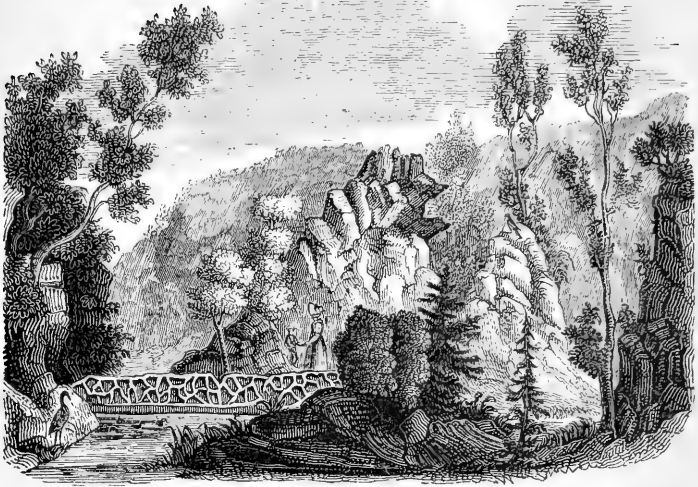


paintings by Mr. Millie's son, which do that young gentleman credit as an amateur artist. The vertical profile was made by Mr. John Sang of Kirkaldy (the son of the eminent nurseryman of that name), who is known as one of the principal land-surveyors in Scotland. Some papers by Mr. Sang in *Jameson's Journal*, on measuring land, have been quoted in a preceding volume, as well as in the *Architectural Magazine*.

The following is the account sent to us by Mr. Millie of his rockwork:—]

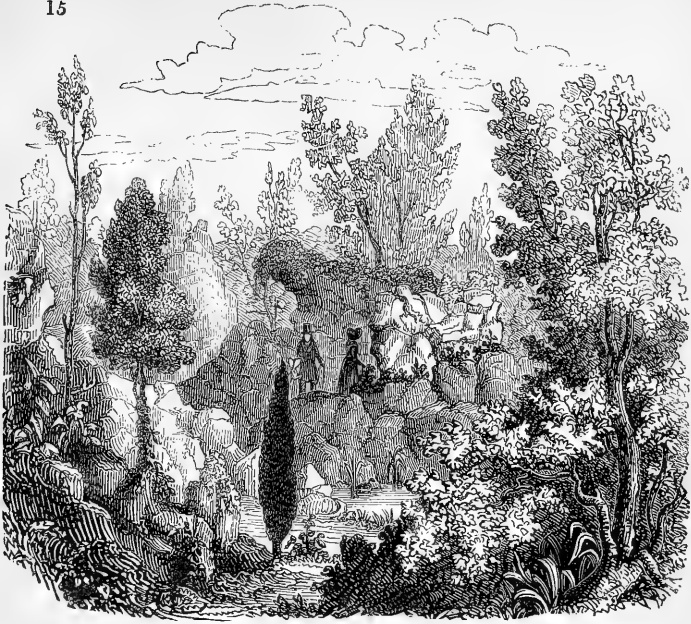
THE rockwork, of which the two views, *fig. 14.* and *fig. 15.*, are given, covers a space of ground 30 paces by 25 paces, in St. Clairtown, county of Fife. Near the centre is an artificial pond, 40 paces in circumference, and from 2 ft. to 3 ft. deep, across which is a rustic bridge. A rocky island rises considerably above the surface of this pond, with cliffs and jutting points for the purpose of producing reflections on the water: round the margin are fragments of dark antique rock, enlivened here and there by sloping pebbly banks. The rocks are piled, to give variety of form; and, as they recede, they rise to irregular and projecting heights, as if from the hand of Nature in one of her freakish moods; here a dark cave, there a rocky ravine, and yonder the track of a cataract which has long ceased to flow, leaving exposed the shelving rocks and the confused masses underneath, apparently scooped out and furrowed by the dashing waters. At this spot, as at most others, the rocks are covered with shining lichens, and richly bespangled with the golden sedum, and other alpine plants. Mosses, heaths, ferns, brambles, broom, whin, and a variety trees and bushes indigenous to the north, protrude in abundance, and overhang the water and the walks, giving the scene quite the appearance of a romantic glen in the Highlands of Scotland. A tame hawk and heron have remained on the spot more than twelve months; the former is generally to be seen perched on a cliff; and the latter, as shown in *fig. 14.*, will stand sentinel-like for days, at the margin of the pond, apparently admiring his shadow, but, in reality, eyeing the goldfish and perch, as they disport in the water; for, though he is well fed by the hand, he shows every disposition to do for himself, and has been detected, once and again, fishing on his own account. A couple of horned owls used to roost in the cave, adding to the picturesque effect; but, during last summer, the heron, who seemed always to bear them a grudge, struck them through with his spear-like bill.

Here, in speaking of the birds that have been tenants of this scene, mention may be made of a large grey gull, the first and, for a time, only tenant of the rock and water, whose noble bearing, on either element, was the admiration of every visitor:



long did he continue to impart an interest to the scenery with which he was in such excellent keeping, and the possession of this bird suggested the idea of forming the small collection that has followed.

The following is the history of the gull: — He had long been suspected of committing depredations on the pond, till at length it was resolved to send him to a gentleman in Clapham Rise, who had three sons quite of an age to appreciate such a present. Consequently, a large hamper was procured, and a stock of fresh haddocks for the voyage, which, with a congratulatory letter, was committed to the charge of a seaman belonging to one of the London smacks. Before sailing, Jack got strict orders to attend conscientiously to the wants of the gull; and was instructed, when he should arrive at the wharf, to call a vehicle, and, like another *chargé d'affaires*, drive alongside the mansion, and deliver his despatches and present in true diplomatic style. To this long yarn Jack listened with seeming attention, and, after quaffing a glass of grog, took good-by'e in these characteristic words: "Shiver my timbers, if I don't do my duty!" The voyage proved tedious almost beyond precedent, and uncommonly stormy: four times were they driven back to the Frith of Forth, after having gained Flamborough Head. Our brave seamen, it is well known, who face real danger unappalled, are, nevertheless, superstitious to a proverb; and the last time they cast anchor in Burntisland Roads, flocks of white and grey gulls floated high in air, and the sea-mews screamed around. A cockney messmate, with ominous look, casting his eye aloft, and



then fixing it on the hamper, where stood the imprisoned gull, accosted Jack in these terms:—“These have been the most heaviest gales we’ve been out in as ever I seed. It was a perfect hurricane last night, fit to blow the teeth out of a fellow’s head. Now, Jack, I’ve just been thinking as how that there hanimal you have got here is the cause of it all. Hang it, I’d let go the tow-line, and set him adrift, I would; no use talking, you know, Jack.” No sooner said than done, and the gull took the water. The honest tar, however, on reaching London, proceeded to Clapham Rise, and delivered his letter; while his blunt story greatly tickled the gentleman and his family.

Two coots, and three water-hens, brought from Kilconquar Loch a year ago, remain on the spot; and, though extremely shy at first, are now often to be seen skimming the pond in quest of flies, or otherwise enjoying a little pastime. A solitary lapwing completes the catalogue of birds attached to the rockery, and by his frequent and well known cry (*peese-weep*) adds much to the natural wildness of the scenery. None of the feathered tribes at large have yet begun to nestle about the place, in consequence of additions being made to the rockwork from time to time, and chiefly in the spring, when the birds are building. The wagtail, oxeye, and stonechatter, however, with the linnet,

blackbird, thrush, and other songsters, are attracted to the spot; not, perhaps, because they admire the picturesque, but because there they find every thing suited to their nature. What makes the circumstance worthy of remark is, that, previously to the laying out of the rockery, scarcely one of the species now enumerated was to be seen; indeed, the locality is quite uninviting to the feathered race, being near the centre of the town, and in the midst of a busy population of 3500. Colonies of the wild bee have been located there for years, and numbers of that industrious insect are seen entering the crevices of the rock, heavily laden with their winter store; while the ear is ever and anon saluted with their deep hum. Intricate footpaths intersect the rocks, two of which lead to eminences commanding a full view of the scene; for, limited as is the spot, it is only when so placed that the eye can embrace the whole. One of the heights so overhangs a part of the pond, that the termination of the water is not perceived; and, consequently, the idea of a subterranean passage is conveyed to the mind. The bridge, too, shown in *fig. 14.*, by intercepting the view across, sets the fancy to work as to the probable extent of water in that direction. Like the rocky part of the scenery, the pond also contains several of the plants most commonly met with in the lochs around; such as the water lilies, white and yellow, the iris, and rushes. A weeping elm, an ash, and a few dangling willows, encircle the edge, and dip their pendent twigs in the water.

The *matériel* for the rockwork was taken from the beach at Seafield, where the masses lie in abundance, presenting the most varied and fantastic shapes, and closely covered with lichen of every hue. The quantity conveyed thence, a distance of three miles, amounts to 130 tons; and the whole has cost about 100%. Considerable difficulty was experienced in making the pond retentive, the subsoil being open; but layers of strong clay were superadded, to the thickness of 2 ft., and now no drainage is perceptible. The pond was at first filled from a pump well; and is supplied, as required, from the same source. In dry weather, occasional pumping is necessary; but in rain, or when the atmosphere is moist, none is required. A lead cistern, the size of a puncheon, is placed at the well; and an inch pipe, attached to the bottom, is carried under ground to the pond: fifteen minutes' work fills the cistern; and, if the plug is withdrawn, the water will continue to flow for an hour, rising up and forcing its way through the rocks to the pond. Perch, trout, and goldfish, all pretty large, and nearly of a size, are in the pond at present: the two latter kinds do not succeed so well; but the perch thrive remarkably: they are so familiar as to feed from the hand, and will even catch at the finger if thrust in the water.

Such a piece of scenery as now described, and of which two

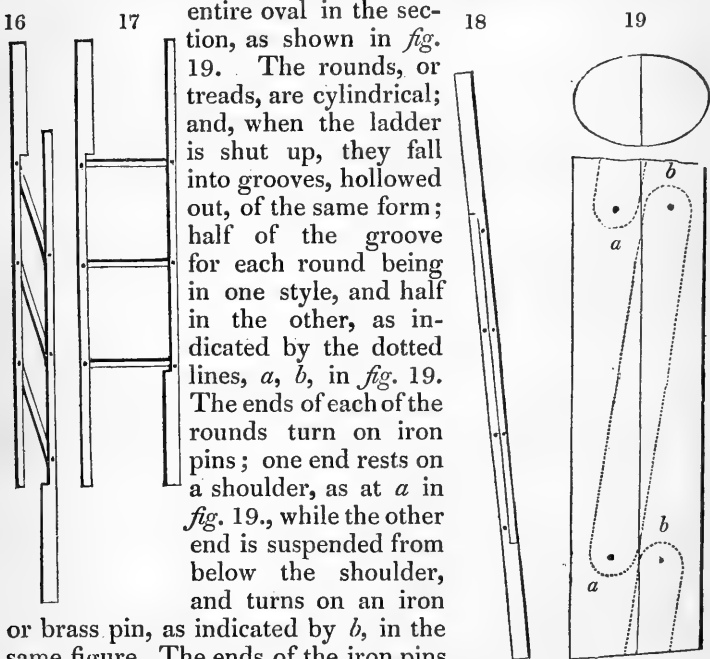
views (*figs.* 14, 15.) are annexed, would form an interesting appendage to any garden, lawn, or shrubbery; and the lover of the picturesque would be amply compensated for the outlay and attention bestowed, by the daily treat it is capable of affording. The aquatic and rock plants, the finny race, and the different species and varieties of the winged tribes, formerly "far to seek, and ill to find," would thereby be brought within the range of every day's observation, and made subservient to purposes at once entertaining and instructive.

As illustrative of the above observation, the writer may state what he himself observed in the garden above described. The day on which the water was let into the pond, he was surprised to observe a number of small creatures, such as he had seen in old ponds, darting from place to place, deep in the water; and, while closely observing their movements, and wondering how they could possibly be there so soon, one of them came to the surface and flew off; and, shortly after, another, borne on airy wing, took the water, and went to the bottom. This amphibious insect is of the beetle species, its wings being encased in a dark horny substance. The cave mentioned in the foregoing account was one of the most difficult parts to construct in all the rockery, in consequence of the large hanging blocks required, several of which took half a dozen strong men to lay; but, now it is completed, the effect is good. The entrance, which is confused and rugged, is 12 ft. high, and the cave runs back, 15 ft. deep, into a mound of earth. Six or eight persons can be seated inside unobserved.

The dots denoting the covered walks in the plan (*fig.* 13.) will appear to be pretty numerous; and to have had all these walks of arched rocks would have been difficult and expensive. On this account, most of them are constructed with strong branches of oak, with the bark taken off, the thickness of a man's waist, closely put together, and covered with mossy turf, two or three turfs thick. In this soil the rowan tree (the mountain ash) thrives, as do some kinds of shrubs. These banks the writer raised when he could not conveniently lay the rocks higher; and they produce a good effect, and shut out the neighbouring houses. The bridge, or rather viaduct, at the drawingroom, leads to the rockery, by throwing open a window, from the second story. Most of the scenery is seen from this window, in consequence of pruning off the side branches of the surrounding trees to near the top; when the effect, through the small trunks, which rise like so many tiny columns, is good, the foliage assuming much the shape of a Gothic arch. It is often amusing to hear visitors exclaim, when taken to this window from the street door, "Whar in all the world are we noo!" — *St. Clairtown, Dec. 1838.*

ART. II. Notice of a light Folding Ladder, adapted for various Purposes in Gardening and Domestic Economy. Drawn up from Notes and a Model communicated by D. BEATON, Gardener to Thomas Harris, Esq., F.H.S., &c., of Kingsbury.

THIS ladder may be constructed of any light elastic wood, of which there are none better and cheaper than yellow Baltic deal; though some East Indian or American woods used by coach-makers may be stronger and more elastic. It may be made of any length, but from 15 ft. to 20 ft. is found most convenient for using in houses, and from 20 ft. to 30 ft. for the open garden or orchard. When the ladder is opened for use, it has the appearance of *fig. 17.*; when half-shut, of *fig. 16.*; and when entirely shut, of *fig. 18.* The section of each of the sides, or styles, is a semi-oval; their junction, when the ladder is shut up, forms an



or brass pin, as indicated by *b,* in the same figure. The ends of the iron pins which pass through the styles, are slightly riveted; or, in ornamental ladders, these ends may be concealed by brass heads, or by heads of ivory or ebony. The ladder may be rendered ornamental in various ways; by painting it so as to resemble any particular kind of wood, or the bark of any particular tree; with or without twiners, epiphytes, mosses, lichens, insects, &c., represented upon it: by using a rare or beautiful kind of wood, and

displaying its veinings to advantage, by varnishing and polishing; or by carving the wood in imitation of a cane or bamboo, cable rope, twining snake, &c.

For garden purposes, the sides may be made of deal, or clean root-cut ash, and the rounds of oak; and for ordinary libraries, the sides may be made of oak or mahogany, and the rounds of the former wood, or of laburnum or yew.

In every description of plant-houses, vineries, verandas, conservatories, aviaries, &c., a folding ladder of this kind is a most convenient article; because, when shut up, it may be carried through a house much easier than a common ladder. For working among climbing plants under glass, it is found to be particularly useful, as it may be introduced in places where there is not room for a common ladder. For pruning standard trees out of doors, it is particularly convenient; because it can be thrust through the branches like a round pole, so as not to injure them; and when once it has been got to the desired place or position, it can be opened, when the styles will press the branches aside, without injuring them.

There is a ladder of this description in the library of Stoke Edith Park, the seat of T. Foley, Esq. M.P.; and one in the villa garden of — Cook, Esq., near Hereford, who may be considered as having introduced these ladders, as he procured the one in his possession (from which the model now sent was made) from a foreign gentleman.

---

ART. III. *An Account of the Trees and Shrubs which were killed or otherwise injured, with a few of those which were uninjured, by the Severity of the Winter of 1837-8, in the Botanic Garden, &c., Oxford.* By W. H. BAXTER.

I WAS glad to see on the wrapper of the April Number of the *Gardener's Magazine*, a request that correspondents in different parts of the country would contribute lists of trees, &c., which suffered from the severity of the winter of 1837-8. Few have as yet been published, but possibly others have been prevented from sending them by the same reason as myself; viz., they have waited to add the length of the young shoots of such as have pushed out, in order, in some measure, to show the condition they are left in to encounter the forthcoming winter; and also to be able to register with certainty those which were entirely killed. This could not have been done with accuracy much earlier in the season; as, in some instances, plants, which were throughout the summer considered dead, are now only just shooting out.

The lowest degree of cold noticed here last winter was on the

20th of January, when, at 8 o'clock in the morning, Fahrenheit's thermometer stood at 1° above zero. Three thermometers in different situations, two in the Oxford Garden, and one in St. Clement's, at the same hour indicated the same degree of cold. The preceding night, at 9 o'clock, and also at 11 o'clock, it stood at 8° above zero.

Names and Remarks.	Height in Feet.	Diameter of Branches in Feet.	In Borders under or against a Wall.	In the Shrubberies.	Exposed.	Dead.	In the Spring apparently dead.	Killed to the Ground.	Checked, but since recovered.	Uninjured.	Length of young Shoots.
<i>Magnoliaceæ</i>											
Magnolia conspiciua	4	-	-	-	+	?+	-	-	-	-	3
purpurea	3	-	-	-	+	-	-	+	-	-	3
<i>Cistaceæ.</i>											
Cistus vaginatus	3	2½	S.W. b.	-	-	+	-	-	-	-	-
scabrosus	3	6	-	-	+	+	-	-	-	-	-
<i>Linææ.</i>											
Linum arboreum	1	1	S.W. b.	-	-	+	-	-	-	-	-
<i>Malvaceæ.</i>											
Lavatera O'bia	7	6	-	-	+	+	-	-	-	-	-
ditto	7	3	-	+	-	-	+	+	-	-	3½
<i>Zygophyllaceæ.</i>											
Meliánthus mājor, an old established patch	-	-	S.E. b.	-	-	-	-	-	-	?+	-
<i>Xanthoxylaceæ.</i>											
Xanthoxylum fraxineum	6½	6	-	+	-	+	-	-	-	-	-
<i>Coriaceæ.</i>											
Coriaria myrtifolia, an old established patch	3	6	-	+	-	-	-	+	-	-	3
<i>Rhamnaceæ.</i>											
Palitrus aculeatus	12	18	S.W. b.	-	-	-	-	-	+	-	-
Rhamnus latifolius	5½	-	-	-	+	-	-	-	-	+	-
<i>Homalinaceæ.</i>											
Aristotelia Mácqui	8	5	N.W. b.	-	-	-	+	+	-	-	2½
ditto	8	10	-	-	+	+	-	-	-	-	-
<i>Leguminaceæ.</i>											
Piptánthus nepalensis	4	-	-	-	+	-	+	-	-	-	-
Edwardsia grandiflora	10	12	W. w.	-	-	-	-	+	-	-	1 to 3
Cytisus scoparius	7	6	-	-	+	-	-	+	-	-	3
purpureus, a worked plant	4	-	-	-	+	+	-	-	-	-	-
ditto, not worked	-	-	-	-	+	+	-	-	-	+	-
multiflorus	4	-	-	-	+	+	-	-	-	-	-
ditto	-	-	-	+	-	-	-	-	-	+	-
Cliánthus puniceus	3	2½	S.W. w.	-	-	+	-	-	-	-	-
<i>Rosaceæ.</i>											
Cérasus lusitánica, possibly sickly previously, but unnoticed	12	-	-	+	-	+	-	-	-	-	-
Others of the same species	12	-	-	+	-	-	-	-	-	+	-
C. Laurocérasus, many plants, most of them old, have suffered in different degrees.	-	-	-	-	-	-	-	+	-	-	1 to 3
Some	-	-	-	+	-	-	-	-	-	-	1 to 3
Others	-	-	-	+	-	-	-	in part	-	-	1 to 3
Spiræa oblongifolia	3	-	-	-	+	?+	-	-	-	-	-
Rosa bracteata, now just breaking below the soil	6	10	N.W. w.	-	-	-	+	+	-	-	3
R. microphylla	6	-	S.W. w.	-	-	-	-	+	-	-	4
semperflorens	10	7	S.W. w.	-	-	-	+	+	-	-	3
Several other plants of the same species, in different situations, have suffered in the same degree.	-	-	-	-	-	-	-	-	-	-	-
Rosa ? semperflorens, or Champney's cluster	12	6	S.E. w.	-	-	-	+	+	-	-	5 to 6



<i>Rosa sempervirens</i> , Pæstum var. -	10	12	S. W. w.	-	-	-	+	+	-	-	6
<i>multiflora</i> álba -	12	-	S. W. w.	-	-	-	+	+	-	-	3
<i>Grevillei</i> -	10	-	S. W. w.	-	-	-	+	+	-	-	11
<i>moschata</i> -	12	6	N. W. w.	-	-	-	in part	-	in part	-	-
<i>rubifolia</i> -	4	-	-	+	-	-	+	+	-	-	4
<i>Banksia lutea</i> -	5	6	S. W. w.	-	-	+	-	-	-	-	-
Standard roses have suffered considerably in the neighbourhood.											
<i>Cratægus heterophylla</i> -	12	10	-	+	-	?+	-	-	+	-	-
<i>Oxy. præcox</i> -	12	8	-	+	-	-	-	-	-	+	-
<i>Photinia serrulata</i> -	6	-	-	-	+	+	-	-	-	-	+
<i>Cotoneaster rotundifolia vulgaris</i> -	2	6	-	-	+	-	-	-	-	-	+
<i>vulgaris</i> -	5	6	-	+	-	?+	-	-	-	-	-
<i>Granatæcæ.</i>											
<i>Punica Granatum</i> -	6	6	S. E. w.	-	-	in part	-	-	-	-	1½
<i>fidre pleno</i> -	12	14	S. W. w.	-	-	?+	-	-	-	-	-
ditto -	12	14	S. W. w.	-	-	in part	-	in part	-	-	2 to 2½
<i>Onagræcæ.</i>											
<i>Fuchsia gracilis</i> -	3	3	-	-	+	+	-	-	-	-	-
<i>longiflora</i> -	4	5	S. W. b.	-	-	-	+	+	-	-	4
<i>Tamaricæcæ.</i>											
<i>Myricaria germanica</i> -	8	6	-	+	-	-	+	+	-	-	-
<i>Philadelphæcæ.</i>											
<i>Deutzia scabra</i> , slightly covered -	3	-	S. W. b.	-	-	-	-	-	-	+	-
<i>Myrtæcæ.</i>											
<i>Myrtus communis romana italica</i> -	3½	4	S. E. w.	-	-	-	+	+	-	-	1½
<i>italica</i> -	3	3	S. E. w.	-	-	-	+	+	-	-	1
<i>Passifloræcæ.</i>											
<i>Passiflora cærulea</i> -	8	10	W. w.	-	-	-	+	+	-	-	3 to 4
<i>Grossulæcæ.</i>											
<i>Ribes sanguineum</i> -	7	6	-	-	+	-	-	-	-	+	-
<i>glutinobsum</i> -	4	3	-	+	-	-	+	+	-	-	5
<i>malvaceum</i> -	4	4	-	+	-	+	-	-	-	-	-
<i>aureum</i> -	8	6	-	-	+	-	-	-	-	+	-
<i>Saxifragæcæ.</i>											
<i>Hydrangea Horténsia</i> , an old plant -	3	5	N. E. b.	-	-	-	+	+	-	-	1½
<i>Cornæcæ.</i>											
<i>Benthàmia fragifera</i> , slightly covered -	3	-	S. W. b.	-	-	-	+	+	-	-	1½
<i>Loranthæcæ.</i>											
<i>Aicuba japonica</i> -	8	8	-	+	-	-	-	-	+	-	-
<i>Caprifoliæcæ.</i>											
<i>Viburnum Tinus</i> , several fine old specimens to the size of -	9	14½	-	-	+	-	+	+	-	-	1 to 3
<i>Compositæ.</i>											
<i>Cineraria maritima</i> -	2½	4	-	-	+	-	-	+	-	-	2
<i>Ericæcæ.</i>											
<i>Gypsocallis vâgans</i> -	-	-	-	+	-	+	-	-	-	-	-
<i>cârnea</i> -	1	-	-	-	+	?+	-	-	-	-	-
<i>Calluna vulgaris</i> álba -	1	1½	-	-	-	?+	-	-	-	-	-
<i>Arbutus U'nedo</i> -	4	-	-	-	+	+	-	-	-	-	1
<i>rûbra</i> -	4	-	-	-	+	+	+	+	-	-	-
<i>Andrâchne</i> -	18	14	-	+	-	-	-	-	+	-	-
<i>Clêthra alnifolia</i> -	3	-	-	+	+	+	-	-	-	-	-
Several rhododendrons, kalmias, azaleas, ledums, &c., have gone off, or nearly so, this season; but the subsoil being very prejudicial to them, they never thrive for any length of time, and were previously become weak and sickly.											
<i>Styræcæ.</i>											
<i>Styrax officinalis</i> -	8	10	S. W. w.	-	-	+	-	-	-	-	-



Top of stem, 1 ft. from the ground, 1 ft. - -	25	15	-	+	-	-	-	-	-	+
<i>Conifera.</i>										
<i>Pinus halepensis</i> - -	10	5	-	-	+	+	-	-	-	+
<i>Cembra</i> - - -	16	10	-	-	+	-	-	-	-	+
<i>Cedrus Deodara</i> , a very exposed situation, slightly covered - -	2	-	-	-	+	-	-	-	-	+
<i>Cupressus pèndula</i> - -	3	-	-	+	-	+	-	-	-	+
<i>Liliàcea.</i>										
<i>Ruscus aculeatus</i> - -	2½	4	-	+	-	-	-	-	+	-
a. <i>laxus</i> - - -	3	3	-	+	-	-	+	+	-	1½
<i>racemòsus</i> , several very fine plants, some others - - -	-	-	-	+	-	+	-	-	-	-
<i>Yucca gloriosa</i> , several very fine specimens, to the height of - - -	7	-	-	-	+	-	+	+	-	2½
In one or two instances the main stems have produced shoots, but since rotted level with the surface of the earth; all have thrown up a profusion of suckers.										

Trees of *Plátanus orientàlis* in the neighbourhood appear to have suffered slightly, there being much dead small wood about them. The same may be said of *Sàlix babylónica*; also of *Ulmus*, *Alnus*, &c.; but, perhaps, they have not suffered more than after our usual winters, though, in ordinary circumstances, we are not apt to give close inspection.

A great many other names might be added; but the situation of the Oxford Garden being very low and damp, we are liable to lose many after a winter of usual severity; and probably many of those which were killed during the severe frost would have died under ordinary circumstances.

The herbaceous ground I cannot attempt to touch upon, as many herbaceous plants fog off every winter.

On the whole, as far as I can see and learn, the actual loss of plants in this neighbourhood is very much less than was anticipated even late in the past spring. We have, I think, greater reason to look forward to the forthcoming winter with fear for the safety of such as were killed to the ground, or severely checked (as in the case of *Quercus Ilex*) last winter, and are now remaining only in a young and weak or sickly state, than we had last spring, to look forward with concern for the appearance of our shrubberies, &c., for the then ensuing summer.

Botanic Garden, Oxford, Oct. 25. 1838.

---

ART. IV. *The Winter of 1837-8 at Munich, and its Effect on the Plants there.* By M. L. C. SEITZ, Royal Court and Botanic Gardener at Munich, from the "Garten Zeitung" for August, 1838.

As the past winter has by no means been one of common occurrence, and as its severity and duration have been felt every where, and even in the south, I thought it would not be unin-

teresting in many respects to describe the character it displayed here; because, compared with information on the subject received from warmer situations, it appears to have been milder here than there. Allow me, therefore, to subjoin my observations.

Sportsmen and country people generally prophesied a cold winter, from the thickness of the plumage of the feathered tribe, and the appearance of birds of passage; but the latter end of autumn, or rather the commencement of winter, proved the contrary. The weather in October was not dry, as is usually the case here, but varied alternately with rain and hail, and just about as much frost as was necessary for the fall of the leaf. In general the trees have completely ripened their summer shoots, and are deprived of their foliage, before November. Instead of which, favoured by the weather, the first days of November that year afforded an unusual treat to the inhabitants of Munich. I allude to the gay appearance of the cemetery, which on All Saints' day displayed the richness of an ornamental flower-garden; and on that day which is consecrated to the memory of the departed, the most beautiful sunshine attracted thousands to enter the cemetery, to enjoy the promenade, and to shed tears of affection on the ashes of their relations and friends which repose there. The all powerful influence of affection was strongly manifested on this occasion; for, if a flower-show had been exhibited, it is hardly possible that more beautiful and rare plants could have been displayed; while in the cemetery their beauty was increased by the numerous sepulchral monuments which they adorned. These beautiful days were followed by heavy rains, and some snow, which was not of long continuance, but varied from one extreme to another every week, which might have been occasioned by the very frequent changes of the wind, as it was in every point of the compass almost every day. Some days the thermometer fell below  $+ 2^{\circ}$  and  $3^{\circ}$  of Réaumur ( $27^{\circ}$  and  $25^{\circ}$  Fahr.), but it soon rose again to  $- 8^{\circ}$  or  $10^{\circ}$  Réaumur. ( $50^{\circ}$  or  $52^{\circ}$  Fahr.); and I should have been in doubt as to there being any necessity for protecting the tender plants, had I not known, from the experience of preceding years, that mild sunless (scheinlos) winters do more harm than severe ones. All kinds of out-door labour could still be performed quite easily; and the black *Nieswurcz*, the marsh violet, the honeysuckle, &c., began to come into flower. The weather continued in this way till about the middle of December, when the east wind set in, and seemed to give the weather a more decided character, as the thermometer indicated  $- 15^{\circ}$  Réaumur. ( $1^{\circ}$  below zero Fahr.) at six o'clock in the morning of the 16th. But in the night of the 18th a violent stormy wind blew from the south-west, which continued to the 26th, and brought heavy rain, and the temperature often rose to  $+ 12$  Réaumur. ( $58^{\circ}$  Fahr.) Thus, Christmas passed over without its having

assumed its usual character, and, instead of snow, the rain fell in torrents, as it does in the tropics, so that it was with difficulty that persons in the open air protected themselves from it. On the 27th the warmth diminished by degrees, so that the thermometer fell to  $-6^{\circ}$  Réaum. ( $19^{\circ}$  Fahr.) at the end of December. The wind, however, was always varying from east to west, the weather dull and foggy; so that there was not a single day which had not an injurious effect on man and plants. The plants in the green-houses were often so covered with moisture, that the houses were obliged to be heated in order to dry them.

From New Year's day the wind blew more from the north and north-east, the weather cleared up, and the cold increased on the 2d to  $-9^{\circ}$  Réaum. ( $11^{\circ}$  Fahr.). The first snow fell on the 5th of January, when the thermometer was at  $-4^{\circ}$  Réaum. ( $23^{\circ}$  Fahr.); it was small, and not in flakes, which indicates continued cold; and on the 9th the glass was at  $-15^{\circ}$  Réaum. ( $1^{\circ}$  below zero Fahr.); on the 15th at  $-16^{\circ}$  Réaum. ( $3^{\circ}$  below zero Fahr.); and on the 23d morning, at six o'clock, the cold had increased to  $-19\frac{1}{2}^{\circ}$  Réaum. ( $12^{\circ}$  below zero Fahr.). It snowed again between the 14th and 15th, but not much; and clear days and nights followed, accompanied by an almost continued north and north-east wind. The covering of snow in this neighbourhood, at this time, did not amount to more than scarcely half a foot in thickness, through which the cold could easily penetrate, and, therefore, great fears were entertained for plants in the open air. Those on the contrary, under glass, were revived and strengthened by the beneficial rays of the sun. The whole of January was equally cold; and it was only on the 29th at noon, that the glass rose to  $+2^{\circ}$  Réaum. ( $36^{\circ}$  Fahr.); and on the 31st, at the same hour, to  $+4^{\circ}$  Réaum. ( $41^{\circ}$  Fahr.), and at night it fell again below zero Réaum. ( $32^{\circ}$  Fahr.) On the same day the wind veered to the west, and brought snow, which was followed by rain in the evening, and held out the hope that the glass would rise, as we were now in February. The barometer was seldom in unison with the weather, and when it fell to 310'' on the 26th of January; we had, indeed, foggy days, but no wind.

A thaw ceased to be looked for on the 2d of February, as the cold recommenced, and the thermometer indicated  $-15^{\circ}$  Réaum. ( $1^{\circ}$  below zero Fahr.) on the 8th, accompanied by some snow. On the same day the wind veered from the east to the south, and at midday the thermometer had risen to  $+3^{\circ}$  Réaum. ( $38^{\circ}$  Fahr.); and on the 9th, at the same hour, to  $+10^{\circ}$  Réaum. ( $54^{\circ}$  Fahr.), accompanied by south wind, and beautiful sunshine, so that it thawed during the night. From the 10th to the 12th of February the thermometer began to fall, after the wind had changed to the west, and some snow had fallen. On the 13th the wind

returned to the north-east, and the cold increased considerably till the 16th; and between the 16th and 19th, during a north-east and west wind, there was such a fall of snow, that in a short time it lay several feet thick on the ground, so that in the morning it was obliged to be shovelled away from the houses. On the 20th, early in the morning, during a cold east wind, the thermometer was at  $-14^{\circ}$  Réaum. (zero Fahr.), which made it almost impossible to remain in the open air; but the warm rays of the sun were beneficial to the green-house plants. In this manner the month drew to a close, without a breaking up of the ice; on the contrary, the few mild days, by a partial thaw, followed by frost, produced such a hard crust of ice on the snow, that only a continuation of south wind and rain could melt it.

February, on the whole, was not so cold as January, but it was more changeable, and more snow fell. The greatest degree of cold in this month was  $15^{\circ}$  Réaum. ( $10^{\circ}$  below zero Fahr.); while in Vienna, between the 19th and 20th of February, the degree of cold was  $-19\frac{1}{4}^{\circ}$  Réaum. ( $12^{\circ}$  below zero Fahr.) It was remarkable that the barometer, which on the 10th of February in the evening was at  $310''\cdot33$ , was on the 11th at noon at  $310''\cdot31$ ; and since the 20th of October, 1825, and the 25th of February, when it was at  $306''\cdot93$ , not the most trifling consequence ensued, or at least was not observed here.

The thaw which was not effected in February, was accomplished in March, as the temperature in the beginning of that month rose from  $+3^{\circ}$  to  $5^{\circ}$  Réaum. ( $38^{\circ}$  to  $41^{\circ}$  Fahr.), accompanied by a west wind, and warm rain; which soon caused the two months' covering of ice and snow to disappear, and presented a welcome scene to the eye. Rain and snow followed, which speedily unfettered the icy bands of the soil; and the winds of March, which succeeded, prepared it for cultivation.

It may be seen from this account that the preceding winter at Munich can by no means be said to have been severe, although of long duration, which, indeed, surprised us, as we are accustomed to a continued change, and, according to all appearances, we may anticipate another normal (average) year.

As soon as the weather permitted, I examined the fruit trees, and tender shrubs, and found, to my great joy, that the unprotected vines, peach, apricot, pear, or plum trees, had not suffered at all.

I next examined the state of the forcing department. Although the commencement of winter was so favourable, the dull foggy days towards the end of December and beginning of January were very injurious. There was, therefore, but little to be seen in the kingdom of Flora: even the hyacinth, the Duc van Thol tulips, and polyanthus narcissus, which used to be seen every where at the New Year, were but rarely met with. Mr.

Seimal, the head gardener at Bogenhausen, however, maintained his usual character, by having a display of the most beautiful plants in flower. His collection of hybrid cinerarias, such as *C. cruenta*, *lanata*, *populifolia*, &c., is quite incomparable; also his assortment of leucojums, which at a glance is the chief ornament of his flower-garden, and which is increased by the high colour of the Turkish ranunculus, and a mixture of the different varieties of schizanthus. Some nurserymen had beautiful camellias, which were much in request during the time of the carnival; and even now, the different kinds of roses present a delightful prelude to the most enchanting period of the year.

The fruit-forcing department, by the court gardener Effner, displays the greatest luxuriance; it is worthy of the greatest consideration and frequent examination, and a plentiful produce may be expected. His mirabelle plums, although they blossomed in the worst time of the year, viz. (between the 15th and 20th of January), are now full of the most beautiful, and almost ripe, fruit; the common plum trees are not less hopeful, as the fruit is already set; and since the beginning of March the cherries have been in full blossom. The vines, some of which blossomed on the 15th of February, have grapes about the size of a large pea, and in large bunches; and ripe raspberries and strawberries have been gathered in great quantities since December. His forcing vegetable department was, in March, in an equal state of forwardness. Nowhere were traces of the long winter seen; but, on the contrary, the refreshing sight of such successful culture rather produced the pleasing impression of a favourable season.

Judging from the weather and the temperature at the beginning of March, it might have been supposed that the month would be dry (which is so desirable every where), but the open weather only lasted about a week, as the glass fell below zero ( $32^{\circ}$  Fahr.) on the 9th, and even  $4^{\circ}$  below it ( $23^{\circ}$  Fahr.), on the 10th. Thick clouds obscured the sun, and brought more snow than grateful rain, so that we rather expected a renewal of winter, than March dust. South and south-west winds prevailed (dry east winds are generally prevalent in March). It thawed, accompanied by rain, from the 14th to the 17th, and on the 19th, the glass rose again to  $+5^{\circ}$  Réaum. ( $43^{\circ}$  Fahr.) Continued changes thus went on during the latter days of March, and almost all April, when the thermometer was, on the second and third morning, at 3 o'clock, at  $+9^{\circ}$  Réaum. ( $52^{\circ}$  Fahr.), and continued so to the 6th, and varied frequently to the 25th. On the evening of the 27th, there was a dreadful storm, with much rain, but snow fell on the 28th; and on the 29th it continued to fall thick the whole day. From such appearances, it was natural to expect a

frosty, instead of a mild, May. Unfortunately, there was  $5\frac{1}{2}^{\circ}$  of frost on the 30th of April, and  $2\frac{1}{2}$  on the 1st of May, so that the plants were, indeed, clothed in snowy whiteness, the emblem of innocence; but, instead of youthful joyfulness, they appeared in a miserable icy covering.

Thus, in the beginning of May, neither gardeners nor farmers could sow their seeds, and the seed corn and garden seeds, which should have been put in the ground in the beginning of March, could only with much difficulty be sown in April; and even such as peas, onions, carrots, &c., which had been sown earlier, by taking advantage of favourable moments, remained dead in the cold soil. Almost every plant in nature was leafless; the prospect of fruit and wine was doubtful, and it was much feared that those plants which had fortunately escaped the winter, would now fall a sacrifice, in what ought to have been the most beautiful time of the year, and this, indeed, proved to be the case with the following: —

*Catálpa syringæfolia*, which had already put out buds, was, during those cold days, killed back even to the strongest branches; also *Amýgdalus commúnis* and *sibírica*, the mulberry, the *Cércis Siliquástrum* and *canadénsis*, *Diospýros Lótus*, *Tília álba*, all the species of *Jùglans*, *Prúnus pùmila*, and *Ribes sanguíneum*, were all severely injured. The latter lost the points of the present year's shoots (des jährigen Holzes), but it flowered beautifully on the old wood. The cherry trees also suffered, particularly the *Weichselm*; also several of the vines which had been pruned, with the exception of the blue *August Traube*, which is the most suitable for our climate. Hardly a single tree has been entirely killed by the last winter's frost, but they have all suffered more or less; particularly *Acer macrophýllum* and *nigrum*; the young stocks of *Ailántus glandulòsa*, *Prúnus prostràta*, *Cydònia*, and the species of *Elæágnus*, only on the present year's wood; all the *Plátanus*, and *Rhús vernix*. *R. Cótinus*, which dies almost every winter with us, remained this year uninjured. (*R. Coriària* does not stand out here at all). *Sàlix babylónica*, and the variety with curled leaves (*S. b. críspa*); several of the *Rosàcææ*, such as *Méspilus germánica* and *Smithii*, *Cratægus punctàta*, *præcox*, *ellíptica*, *pentágyna*, *Pyracántha*, and even *Oxyacántha*, with many others, have also suffered much, but more in consequence of the dryness of the early part of the summer, than from the severity of the winter. This was also the case, in the spring of 1837, with many groups of *Acer tatáricum*, *Negúndo fraxinifòlium*, and many poplars and species of ashes. We may probably live to see similar consequences in future successive years.

On the contrary, the following, which we consider tender, stood the early winter's cold without the least injury; viz. *Acer*



lobatum, neapolitanum, pennsylvanicum, Lobèlii, créticum; *Ne-  
gundo fraxinifolium* var. crispum; *O'rnus europæa*, rotundifolia;  
*Ailantus glandulosa*, *Salisbùria adiantifolia*, *Gymnócladus*  
*canadénsis*, *Plánera Richárdi*, *O'strya vulgàris*, *Maclùra auran-  
tiaca*; *Prùnus nigra*, serótina; *Cotoneáster affinis*, acuminata,  
*Nummulària*, and [?] uniflora; species of *Calycánthus*, *Hydrán-  
gea quercifolia*, *Pæonia Moutan*, *Rhododéndron* sp., *Azàlea* sp.  
(under a slight covering), *Spiræa bélla* and *ariæfolia*, *Céltis*,  
*Colutea* (which are generally killed down every year, even to  
the root stock? *Wurzel Stock*), *Gleditschia*, *Amórpha*, *Sophòra*  
*japónica*, *Xanthóxyllum fraxíneum*, *Hibíscus syriacus*, and all  
the kinds of *Ribes*. There was no particular injury done to the  
roses, except a few of the most valuable kinds. The kinds of  
the pine and fir tribe which can be grown here stood the winter  
well; such as *Pinus Stròbus*, *canadénsis*, *balsàmea*, [?] *mariàna*,  
*Pináster*, *Larício*, *rígida*; *Juníperus virginiana*, *prostrata*; *Thuja*  
*occidentális* (*T. orientális* and *Taxòdium dístichum* never at-  
tain a great age here). The fruit trees only suffered from the  
late frosts; at the same time, in many places, there are apples,  
apricots, and green gages and other plums, in abundance. On  
removing the winter covering of beech leaves from plants in the  
open air, they were almost all found alive, and in a healthy state:  
and it excited not a little astonishment, to find small plants alive,  
that had been entirely left to their fate; such as, for example,  
some species of *Calceolària*, *Verbèna*, several Neapolitan *Crucí-  
feræ* and *Liliàcæ*, *Ròhdea japónica*, *Oxalis crassicaúlis*; *Pole-  
mónium mexicànum*, pulchellum; *Lysimàchia dùbia*, *anagallòides*;  
*Michaúxia campanulòides*; *Férula neapolitana*, *tingitana*; *Séseli*  
*buchtorménse*, *gummíferum*; *Teùcrium Màrum*, *orientale*; *A'n-  
themis nóbilis romana*, species of *Liàtris*, and many others.

The aquarium, covered in the most simple manner, did not  
freeze in the least, which was partly owing to the uninterrupted  
flow of the water; all the plants it contained were found in  
a good state, and even *Càlla æthiòpica* and *Nymphæa cærùlea*  
were found alive.

From these few remarks, the favourable result of the effect of  
the winter on the plants here may be readily perceived, and I  
shall consider myself fortunate if I never live to see one more  
destructive.

In the night of the 18th of August, after a beautiful sunny  
evening, the temperature became so low, that the thermometer,  
on the 19th, at 4 o'clock in the morning, in the botanic garden,  
was at 1° below zero Réaum. (30° Fahr.) In the gardens in the  
suburbs, and in the adjacent fields, a strong hoar frost was per-  
ceived, but no material injury was effected. It was a very rare  
occurrence at this time of the year, and the more so, because we  
had had dry warm weather for many days previous, accompanied

by very little dew. Nobody here hardly ever remembers so early a frost, but it indeed appears in general unison with the extremes of this year. A few agreeable days in the month of May could scarcely be enjoyed, because a damp coldness prevailed during the whole month; though this, with the heat that followed, was certainly favourable to vegetation, and put a check everywhere to the voracious caterpillars. We experienced an almost insupportable heat during the months of June and July, when the thermometer continually varied between  $+23^{\circ}$  and  $25^{\circ}$  of Réaumur ( $80^{\circ}$  to  $85^{\circ}$  Fahr.). On the 15th of July, at 2 o'clock in the afternoon, it was at  $+26.5^{\circ}$  Réaum. ( $90^{\circ}$  Fahr.), and it was feared that it would rise still higher during the dog days; but, after a storm on the 26th of July, when the vicinity of Landsberg, on the Lake of Geneva, was visited by a destructive fall of hail, the temperature became so low with us, that it was felt painfully. At first, it was supposed that this was occasioned by the storm, but we were soon informed that the like is experienced even in warmer countries. Thus passed away those days (which in other years are so warm), in continual rain and cold, till the 10th of August, when dry and warm weather again set in, and the countryman, in most places, had the satisfaction of housing his fruit. A tract of country, however, including Regensburg, and a mile and a half round it in breadth, and five miles in length, was visited by a tremendous hail storm on the 5th of this month, when birds and small animals were found killed by it, and the hope of fruit was annihilated for many years to come. (*Garten Zeitung*, No. 36. p. 286., Aug. 1838.)

---

ART. V. *Botanical, Floricultural, and Arboricultural Notices on the Kinds of Plants newly introduced into British Gardens and Plantations, or which have been originated in them; together with additional Information respecting Plants (whether old or new) already in Cultivation: the whole intended to serve as a perpetual Supplement to the "Encyclopædia of Plants," the "Hortus Britannicus," the "Hortus Lignosus," and the "Arboretum et Fruticetum Britannicum."*

*Curtis's Botanical Magazine*; in monthly numbers, each containing seven plates; 3s. 6d. coloured, 3s. plain. Edited by Sir William Jackson Hooker, LL.D., &c.

*Edwards's Botanical Register*; in monthly numbers, new series, each containing six plates; 3s. 6d. coloured, 3s. plain. Edited by Dr. Lindley, Professor of Botany in the London University.

*Maund's Botanic Garden, or Magazine of Hardy Flower Plants cultivated in Great Britain*; in monthly numbers, each containing four coloured figures in one page; large paper 1s. 6d., small 1s. Edited by B. Maund, Esq., F.L.S.

*Paxton's Magazine of Botany, and Register of Flowering Plants*; in monthly numbers; large 8vo; 2s. 6d. each.

*The Floral Cabinet*; in monthly numbers, 4to; 2s. 6d. each. Conducted by G. B. Knowles, Esq., M.R.C.S., F.L.S., &c. and Frederick Westcott, Esq., Honorary Secretaries of the Birmingham Botanical and Horticultural Society.

*The Botanist*; in monthly numbers, each containing four plates, with two pages of letterpress; 8vo; large paper, 2s. 6d.; small paper, 1s. 6d. Conducted by B. Maund, Esq., F.L.S., assisted by the Rev. J. S. Henslow, M.A., F.L.S., &c., Professor of Botany in the University of Cambridge.

### RANUNCULACEÆ.

2011. PLATYSTEMON  
leiocarpus Fisch. & Meyer smooth-fruited O or 1 in. au Siberia 1837. S co Fl. cab. 2. p. 129

This plant, which appears nothing more than a smooth-fruited variety of *P. californicus*, was raised in the Botanic Garden, Birmingham, from Russian seeds. It grows vigorously, and both it and *P. californicus* have ripened abundance of seeds. (*Flor. Cab.*, Nov.)

### Violaceæ.

701. VIOLA 5707 palmata var. variegata, *Bot. Gard.*, No. 675.

A variety of *Viola palmata*, which has the flowers variegated with blue and white. It is a native of North America. (*Bot. Gard.*, Jan.)

### Malvaceæ.

2011. PAVONIA Schrânki Spreng., *Bot. Mag.*, 3692.  
Synonymes : 2013 Lebretonia 17925 coccinea Schrank.

Sprengel considers this species to belong to *Pavonia*, and, consequently, has united *Lebretonia* to that genus. A plant of it received from the Botanic Garden, Berlin, flowered freely in the stove in the Botanic Garden, Edinburgh, in July, 1837; "but though its blossoms are of considerable size, and not destitute of beauty, the plant will probably never be a favourite in cultivation, because its flowers are only expanded during the forenoon, and the shrub is coarse, and in no degree attractive." (*Bot. Mag.*, Nov.)

2005. NUTTALLIA grandiflora *Paxt. Mag. of Bot.*, v. p. 217.  
? Synonyme : 17844 N. digitata Dick.

"It appears to thrive best in a somewhat sheltered situation, though we believe it to be quite hardy. Any open loamy soil will be found suitable; and, under favourable circumstances, it will sometimes attain the height of 3 ft. or 4 ft., all its branches being studded with flowers." The seeds ripen abundantly, and the plant may be increased by them, or by "cuttings of the young shoots, taking care to avoid those which evince any disposition to flower." (*Paxt. Mag. of Bot.*, Nov.)

2004. MALVA  
17830 miniata var. Creeana.  
Synonyme : M. Creeana Hook., *Bot. Mag.*, t. 3698.

A very pretty red-flowered mallow, raised by Mr. Penny of the Milford Nursery, and named by him in honour of Mr. Cree of the Addlestone Nursery, an excellent practical botanist and cultivator. (*Bot. Mag.*, Dec.)

2014. *HIBISCUS*\*Cameróni Knowl. & West.  $\star$  □ or 1 jn Ro Madagascar 1837. C l.s.p Fl. cab. no. 82.

A pretty species of *Hibiscus*, raised in the Birmingham Botanic Garden, from seeds collected by missionaries in the Island of Madagascar, and named in compliment to Mr. Cameron, "the able and indefatigable curator of that garden." The plant is of very slow growth, and will probably long continue rare, as it has neither produced any lateral shoots for cuttings, nor ripened any seeds. (*Floral Cabinet*, Jan.)

*Leguminosæ.*1940. *HOVEA*\*Manglèsi Lindl. Capt. Mangles's  $\star$  □ pr 1 ja P Swan River 1836. C co Bot. reg. 2d [ser. 62.]

"A green-house shrub, requiring plenty of light and air, but not particularly delicate. It is readily increased by cuttings." It is one of the many fine plants which we owe to the botanic zeal of Captain James Mangles, and it is therefore most appropriately named after him. (See *Bot. Reg.*, Nov.)

+ *Mimosa marginata* Dec. "A shrubby plant, half-hardy, prostrate, and producing long slender shoots, which have an elegant appearance if allowed to hang down from the rafters of a green-house." The flowers are purple, and are placed on very long peduncles. It will not only live, but increase rapidly, in the open border, as the branches, if suffered to rest on the ground, will throw out roots at every joint. "It is said to have survived the winter of 1836-7 in the open border; in the nurseries it is sold under the names of *M. mexicana*, *scandens*, and *prostrata*." (*B. M. R.*, Nov., No. 152.)

*Rosaceæ.*1528. *POTENTILLA*\*ferruginea rusty-coloured  $\star$  Δ or 1 jl.au O.B hybrid 1835. D co Paxt. mag. [of bot. v. 223.]

This is a hybrid between *P. atrosanguinea* and *P. pedata*. The foliage resembles that of the latter species; and the flowers are of a deep orange, richly tinted with dark brown. "It was raised about three years ago, and presented to Messrs. Rollisson of the Tooting Nursery, by a friend." (*Paxt. Mag. of Bot.*, Nov.)

*Onagræceæ.*1188. *FUCHSIA*\*cylindracea Lindl. cylindrical-flowered  $\star$  □ el 2 au S Mexico 1837. C pl Bot. reg. [1480.]

This species has been already noticed (p. 375.) as having appeared in the *Bot. Reg. Miscellany*. Dr. Lindley observes of the male and female flowers of this genus, that "the latter are the less showy of the two, their flowers not being half the size of those of the males." He also remarks that some plants have

all their flowers male, and others all female. "According to Professor Zuccarini all the small-flowered Mexican species, with enclosed stamens, are polygamous." (*Bot. Reg.*, Dec. ; and *Fl. Cab.*, Jan.)

*Melastomàceæ.*

+ *Medinilla erythrophylla* Lindl. A small shrub, with bright rose coloured flowers, arranged in axillary cymes. The leaves are of a deep red when young, but they become of a bright green when old. This rare and beautiful plant was sent home from India by Mr. Gibson. (*B. M. R.*, Nov., No. 158.)

*Alangiàceæ.*

3341. *MARLEA*, 28207 *begoniæfolia* Roxb., *Bot. Reg.* 2d ser. 61.

This tree, which is a native of Sylhet, has been in the country many years, for Dr. Lindley mentions that he has a specimen of it, which was dried in the Cambridge Botanic Garden by Donn in 1805, though it has "not found its way before into any work containing figures of plants." (*Bot. Reg.*, Nov.)

*Càctææ.*

3358. *MELOCACTUS* *depressa* Hook., flattened.

*Synonymes*: *Cactus* 12513 *depressa* Dec., *Echinocactus* *depressa* Lk. & O.

"This is one of the few *Càctææ* which have rewarded Mr. Gardener's researches in the vicinity of Pernambuco;" from which place several specimens of this species "were sent to Woburn Abbey, and to the Glasgow Botanic Garden. The flower is at present unknown, probably it is small and red, like what we know of other *Melocacti*; but they had blossomed freely previous to their having been embarked; and after their arrival copious seed-vessels were produced, long, and of a delicate, transparent rose colour, which, rising in a circle considerably above the crown of red aculei, presented an appearance perhaps more striking than the flowers themselves." (*Bot. Mag.*, Nov.)

*Saxifragàceæ.*

*ACROPHYLLUM* *venosum* Benth., *Bot.* No. 95.

*Synonyme*: *Weinmännia* *venosa* Fl. Cab.

*Caprifoliàceæ.*

626. *LEYCESTERIA* 5243 *formosa* Wall.; *Bot. Reg.* 1839, 2.; and *Bot. Mag.* t. 3699. See also *Arb. Brit.* fig. 827., and *Gard. Mag.* xiii. fig. 1.

By the figure of this plant in the *Botanic Register* for January, 1839, the flowers appear to have crimson bractæas, instead of purple ones, as described in our *Arboretum Britannicum*, vol. ii. p. 1060. From the specimen raised in the Horticultural Society's Garden, from seeds sent there by Dr. Royle, it does not appear so ornamental as it was expected to be; but it is hardy, having sustained the severe cold of 1837-8 without protection. (*Bot. Reg.*, Jan.) A plant in the Edinburgh Botanic Garden flowered in July, 1838, in moderate heat; and according to the figure in the *Botanical Magazine*, with larger leaves, but paler bractæas, than in the Horticultural Society's Garden. (*Bot. Mag.*, Jan.) Dr. Lindley says: — "Although not so handsome as was anticipated,

Leycesteria may become more ornamental as it grows older and acquires a larger size. The best method of improving the appearance of the plant will be to station it where, without being exposed to a very dry atmosphere, it is fully under the influence of light. It becomes yellow and unhealthy in front of a south wall; but flourishes in an exposure to the east or west. It multiplies freely by cuttings or layers." (*Bot. Reg.*, Jan.)

*Compositæ.*

2409. HELIANTHUS 21940 môllis Willd., Bot. mag. 3689.'

The *Helianthus môllis* of Willdenow has been generally supposed to be the same as the *H. pubescens Vahl*, which was figured in the *Botanical Register*, t. 524.; but, on comparing them, that figure appears essentially different from the present plant. *H. pubescens* was also figured in the *Botanical Magazine*, t. 2778.: but Sir W. J. Hooker supposes this not to be the species described by Vahl, but the *H. tomentosus* of Michaux; and that, with *H. môllis*, there are three distinct species.

The *H. môllis* now described is a perennial, about 4 ft. high, with the stems more or less scabrous, and deeply tinged with dark purple. The leaves are ovate-lanceolate, mostly on very short footstalks, slightly tapering at the base, and acuminate at the point. They are generally glabrous, and dark green above; and pale, glaucous, or dotted more or less copiously with soft down, beneath. The margin of the adult leaves is rather distantly, and not deeply, serrated. The petals are of a bright yellow, and somewhat linear. (*Bot. Mag.*, Nov.)

2323. HELICHRYSUM

\**macranthum Benth.* large-flowered O or 2 au.s W Swan River 1838. S co Bot. reg. 2d

[s. 58., and Bot. no. 92.

A native of the Swan River, which, according to the *Botanical Register*, appears to have first flowered in the garden of Robert Mangles, Esq., Sunning Hill; but, in the *Botanist*, it is stated that it was first brought to Europe by the Baron Von Hügel, who raised plants of it in his garden at Hietzing, near Vienna; from which place plants were obtained by Messrs. Rollisson, at Tooting. It is stated in the *Botanist*, that it requires to be kept in the greenhouse; but we saw it ourselves last summer flowering beautifully in the open ground, in the nursery of Mr. Rogers, Eaton Square, Pimlico. It somewhat resembles the common white variety of the *Helichrysum bracteatum*; but the flowers are much larger, and of a rich cream colour, rather than pure white; and the petals have beautiful rosy tips. (See *Bot. Reg.*, Nov.; the *Botanist*, Nov.; and *Part. Mag. of Bot.*, Dec.)

2273. STEVIA

\**fascicularis Dec.* close-headed  $\frac{3}{4}$  pr 1 or W Mexico 1837. C co Bot. reg. 2d ser. 59.

"A pretty, sweet-scented green-house plant; . . . a native of Mexico, whence the seeds which produced the plant figured,

were imported by G. F. Dickson, Esq., F.H.S., and presented to the Horticultural Society." (*Bot. Reg.*, Nov.)

2337. *A'STER*  
*cassiarábicus* ? *Fisch. & Mey.* Δ or 2 s P Russia 1834. D co Bot. gard. no. 672.

Nearly allied to *A. Améllus*, but superior in depth of colour and vigour of growth, and a more abundant flowerer. It was raised in the Birmingham Horticultural Society's Garden in 1834, from seeds received from Russia. "It may probably be the *Aster ibéricus* of Stevens, which De Candolle considered a variety of *Améllus*." (*Bot. Gard.*, Dec.)

2280. *MARSHA'LLIA*  
*\*caespitosa* *Nutt.* tufted ♀ Δ | or 1 jl.au P.W Texas 1837. D co Bot. mag. 370c.

This species of *Marshállia* was first discovered by Nuttall, but it was sent to England by Drummond, in his third collection of the seeds of Texas. Seeds sown in the Glasgow Botanic Garden flowered in a cool frame in July and August. (*Bot. Mag.*, Jan.)

*Lobeliàcæ.*

609. *LOBE'LIA*  
*\*ramosa* *Benth.* branching ♀ Δ or 2 jn.o D.B Swan River 1838. D co Bot. no. 93.

A pretty, free-growing, perennial *Lobèlia*, raised in the garden of the London Horticultural Society, from seeds received from the Swan River, by Captain James Mangles, R.N. "It appears confined to South Western Australia, for the specimens received from Van Diemen's Land, and figured in the *Botanical Register*, t. 2014., are probably the true *Lobèlia heterophýlla*, or some other allied species." It remains in flower in great beauty for several months, and grows very freely, either singly, or in beds; requiring only winter protection from frost. It continues to flower a long time after being gathered and placed in a room." (*Botanist*, Nov.)

*Gesneriàcæ.*

1702. *GLOXY'NIA*  
*\*máxima* *greatest* ♀ □ or 1 jl.au P.W hybrid 1837. D s.p Paxt. mag. of bot. v. 219.

This is a hybrid raised in the Epsom Nursery, from *G. spinosa*, and *G. cándida*. The flower is very large, and white, with a deep stain of mazarin blue, or purple, in the mouth of the corolla. (*Paxt. Mag. of Bot.*, Nov.)

*\*Cyrtandràcæ.*

*\*ÆSCHYNA'NTHUS* *Jack.* THE ÆSCHYNANTHUS. (From *aitshunö*, to be ashamed, and *anthos*, a flower; colour.) [Paxt. mag. of bot. v. 241.]

*\*grandiflorus* *G. Don* large-flowered ♀ □ or 5 au.s S B.G.Y Khosea 1838. C p.r.v  
*Synonymes:* *Incarvillea parasitica* *Roxb.*, *Trichospérmum grandiflorum* *D. Don.*

This is one of the most splendid, and at the same time one of the most remarkable, plants which have ever been introduced into this country. It is an epiphytal twining shrub, with a large head or umbel of splendid orange-scarlet flowers, each flower as large as the flower of the foxglove. This superb plant was one of those brought home by Mr. John Gibson, the Duke of Devonshire's collector in India; where he found it in

the moist shady valleys, among the Khosea Hills, twining from tree to tree, and hanging down in elegant festoons, from off which spring numerous projecting shoots, each of which was crowned with an umbel of splendid flowers. The elevation of these valleys is not more than 1000 ft. above the level of the sea; and the plant was in blossom during their cold season. It has been generally supposed to be a parasite, but Mr. Paxton found it to succeed perfectly well, with the usual treatment of epiphytes; observing, from the description of its native habitat, to keep it in a moist and shady situation during the growing season. It flourished most luxuriantly on pieces of *dead* wood, to which it soon attached itself; as it emits roots from every joint. Mr. Paxton also informs us that "it may be multiplied with remarkable facility by cuttings, which should be planted in reduced moss, covered with a bell glass, and placed in a brisk bottom heat. One joint will be sufficient for the purpose, and will form a strong plant in a very short time, provided it be judiciously treated." (*Paxt. Mag. of Bot.*, Dec.)

*Ericàcææ.*

1173. *ERICA*  
*pseudovestita* Bot. hybrid clothed  $\pi$   $\square$  pr 2 my Pk hybrid. C s.p Botanist, no. 104.

A pretty hybrid heath, raised by Mr. Williams, gardener to John Wilmore, Esq., of Oldford, apparently from seed of *E. vestita*. (*Botanist*, Jan.)

*Apocynàcææ.*

*TANGHINIA* *Manghas* Flor. Cab. 2. p. 133.  
*Synonyme* : 550 *Cerbera* 4464 *Manghas* Ham.

*Convolvulàcææ.*

+ *Ipomœa tyriánthina* Lindl. The flowers are of a rich dark purple, and fully  $2\frac{1}{2}$  in. long, growing on long graceful penduncles. The stem is shrubby, and the plant may be increased by cuttings. This beautiful flower was introduced by G. F. Dickson, Esq., who obtained the seeds from Mexico, and presented them to the Horticultural Society, in one of whose plant-houses the species flowered in October last. (*B. M. R.*, Nov., No. 162.)

*Solanàcææ.*

591. *SOLANUM*  
*Herbertianum* Hort. Herbert's  $\pi$   $\square$  or 2 jn.au P.Y ... 1833. C ls Paxt. mag. of bot. v. 269.

This very pretty solanum is a dwarf neat-growing species, very different from most of its congeners. The flowers are of a dark purple, with a yellow stripe up each petal. Its height seldom exceeds 2 ft., and its flowers are seen to most advantage when looked down upon from above. It is a stove plant, and requires a humid atmosphere. (*Paxt. Mag. of Bot.*, Jan.)

*Scrophularinàcææ.*

1501. *COLLYNSIA*  
*\*heterophylla* Nutt. various-leaved  $\circ$  or  $1\frac{1}{2}$  jl.au P.W Colombia 1838. S co Bot. [mag. t. 3695.]



A very handsome species of *Collinsia*, somewhat resembling *C. tricolor*, but having much larger and more showy flowers. It was found by Nuttall on the Columbia, and was raised at the Experimental Garden, Edinburgh, by Mr. James M'Nab, from seeds transmitted to him under the name adopted, by Mr. Buist of Philadelphia, in spring last. (*Bot. Mag.*, Dec.)

*Labiàtea.*

+ *Gardoquia betonicoides*. "Raised by Messrs. Lowe and Co. from Mexican seeds. It is an erect, sweet-scented, herbaceous plant, with the upper part of its stem producing from every axil its cymes of bright purple flowers, which give it the appearance of a *Betónica*." (*B. M. R.*, Nov., No. 159.)

*Verbenàcea.*

1749. VERBENA [mag. t. 3694., and Paxt. mag. of bot. v. p. 243.  
*\*teucricoides* Gill. & Hook. Germander-like  $\Delta$  or  $\bar{2}$  au W.Pk S Amer. 1837. D co Bot.

This is perhaps the most beautiful of all the beautiful genus *Verbena*. The plant is erect, and grows about 2 ft. high; its flower-spike is generally more than 6 in. long; the flowers are of a delicate pinkish white, gradually deepening into a rich rosy pink as they begin to decay; and they are delightfully fragrant. It is supposed to be quite as hardy as any of the other species; and it is of remarkably strong and vigorous growth. It was first described by Sir W. J. Hooker, in the *Botanical Miscellany*, vol. i. p. 167., from specimens collected by Dr. Gillies "from the highest ridge of the Nepallata Mountains, in South America, at an elevation of 10,000 ft. above the level of the sea." No seeds were, however, received from Dr. Gillies, and the plant was introduced by Mr. Tweedie, who found it on Monte Video, and on the Sugarloaf Mountain of Maldonado. It first flowered in the Glasnevin Botanic Garden, in August, 1838. Messrs. Handyside, nurserymen, of Musselburgh, have purchased the whole stock; and, as it strikes readily from cuttings, they will have plants ready for sale in April, 1839. (*Botanical Magazine*, and *Paxton's Magazine of Botany*, Dec.) The figure of *Verbena teucricoides*, in *Paxton's Magazine of Botany*, is, for botanical accuracy and delicacy of shading and colouring, equal to anything that has yet appeared; and, indeed, this periodical is now everything that we could wish it to be. We sincerely trust that the editor and publishers will take effectual care that it does not degenerate into the state in which it was six months ago. (See H. N. H. in our preceding volume.)

*Aristolochiàcea.*

2582. ARISTOLOCHIA D s.l.p Bot. no. 96.  
*\*ciliösa* G. B. fringed  $\square$  cu ?6 s P.G North Patagonia 1836. D s.l.p Bot. no. 96.

The flowers of this species, though curious, do not make much show. It is a native of South America, whence it was sent by Mr. Tweedie, in 1836, to the Glasnevin Botanic Garden, where it flowered in 1837. (*Botanist*, Dec.)

## Orchidæcæ.

## \*CHLORÆA

longibractæata *Benth.* long-bracted £ ☒ cu 1 s.o. W.Y Chile 1837. D 1p Bot. no. 94.

“The genus *Chloræa* comprehends about twenty-two species, all natives of the Chilian states, where they are to be found from the verge of perpetual snow on the Andes. Some few, like a portion of our British orchises, embellish the rich grassy meadows of the valleys; but the greatest number prefer those dry rocky wastes which give to the mountainous districts of Chile so desolate an appearance in summer. . . . Although the flowers of the original species are of a greenish colour, which occasioned the adoption of the name of *Chloræa* for the genus, still several of those discovered by Dr. Pöppig have large flowers of a pure white, or of a rich yellow, and are highly ornamental.” This species is the first of this interesting genus that has been introduced into England. It was brought from Valparaiso by Mr. Crook in 1837, and flowered for the first time in the stove of W. J. Myers, Esq., of Aigburgh, near Liverpool. (*Botanist*, Nov.)

2555. CATTLE'YA 28722 guttata var. *Russelliana* Hook., *Lord Edward Russell's*, Bot. Mag. t. 3693.

A superb variety of *Cattleya guttata*, which “was brought to the Woburn collection from Brazil, together with many other rare South American vegetable productions, in the spring of 1838, by Captain Lord Edward Russell, R.N.,” to whom it was given “by the director of the Botanic Garden at Rio, with the information that it was one of two specimens that had been recently discovered in the Organ Mountains.” (*Bot. Mag.*, Dec.)

## 2547. DENDROBIUM

\*sulcatum *Lindl.* furrowed £ ☒ or 1 ap O India 1837 D moss [ser. t. 65- Bot. reg. 2d]

A very singular species, brought over from India by Mr. Gibson, which flowered at Chatsworth in April last. “It is a fine species, nearly related to *D. Griffithianum*, from which it differs in its three-flowered peduncle, and in the form of the lip.” (*Bot. Reg.*, Dec.)

+ *D. denudans* D. Don. This species was sent home by Mr. Gibson, the Duke of Devonshire's collector in India. “The stems are erect, about 6 in. high;” and “are covered with a profusion of nodding racemes of rather small green and white flowers.” (*B. M. R.*, Nov., No. 156.)

## 3412. STANHOPEA

*tigrina* *Bate.* tiger-flowered £ ☒ or 2 jn.jl P.Y Mexico 1837. D p.r.w Bot. reg. 1839, 1.

This species was figured by Mr. Bateman, in his splendid work on the Orchidæcæ of Mexico and Guatemala, but, by some mistake, was omitted by us in our Floricultural Notices for the past year, though referred to in our notice of No. 2. of Mr. Bateman's work. (See Vol. XIV. p. 435.) The flowers of this species are longer and handsomer than those of any other species of the genus, not even excepting those of “the magnificent *S. devoniensis*.” “It was originally imported from the neigh-

bourhood of Xalapa, by Messrs. Lowe and Co.;" and is one of "the easiest of the genus to cultivate." If grown in a pot, it must be raised above the rim, to prevent it from suffering by too much water, and to display its pendulous flowers to advantage. If hung up in a basket, the latter should be lined with sphagnum, in which the roots seem to thrive. Whether cultivated in a pot or a basket, the plant must be kept perfectly dry when not in a growing state. (*Bot. Reg.*, Jan.)

\*EPITHECIA. (From *epithēkē*, an appendage; shape of the flower.)  
glauca *Knowl. & West.* glaucous £ □ el  $\frac{1}{2}$  in G.P. Mexico 1837. D r.w Fl. cab. no. 87.

An elegant little plant, with green and purple flowers, nearly allied to *Epidéndron*. It is a native of Mexico, and was introduced by Mr. Barker. (*Fl. Cab.*, Jan.)

\*PAXTONIA [2d ser. 60. (B. M. R. no. 113.)  
rosea *Lindl.* rose-coloured £ Δ| p.r  $\frac{1}{2}$  s.o Pk Philippine Islands 1837. D p.l Bot. reg.

"This curious plant," says Dr. Lindley, "was sent to Messrs. Loddiges from Manilla, by Mr. Hugh Cumming, who has been for some time engaged in exploring the Philippine Islands. It is so entirely different from all orchidaceous genera hitherto discovered, that I know not with what to compare it." The column and the lip in this order are different from the usual structure of plants. The column consists of the stamens and style consolidated; and the lip is so much like the other petals, as only to be recognised by its position. (*Bot. Reg.*, Nov.)

2530. CATASETUM [63. (B. M. R. 114.)  
\*atratum *Lindl.* dark-flowered £ □ or 1 au s var. Brazil 1837. D p.r.w Bot. reg. 2d ser.

"A very distinct species of this curious genus, imported by Messrs. Loddiges from Brazil. The flowers are gracefully drooping, and are among the handsomest of the genus." (*Bot. Reg.*, Nov.)

+ *C. poriferum* *Lindl.* "This is a remarkable species sent to Messrs. Loddiges from Demerara by M. Schomburgk." It is most nearly allied to *C. deltöideum* (*B. M. R.*, Dec., No. 164.)

2538. COMPARETTIA  
\*cocinea *Lindl.* scarlet £ □ or  $\frac{1}{2}$  au S ? Brazil 1837. D p.r.w Bot. reg. 2d ser. 68.

"This beautiful and very rare epiphyte flowered with Messrs. Loddiges in August last, and is said to be a native of Brazil; it, however, agrees so entirely with dried specimens collected near Xalapa, that some mistake is to be suspected in its reputed country." (*Lindl.* in *Bot. Reg.*, Dec.)

+ *Maxillària Collèyi* *Bate.* This species has "dingy flowers," the smell of which is "like that of an over-ripe melon." (*B. M. R.*, Nov., No. 161.)

+ *M. porrècta* *Lindl.* A species from Rio Janeiro, with pale buff flowers. (*B. M. R.*, Dec., No. 173.)

+ *M. macrophýlla* *Pöppig et Endl.* "Very like *M. Déppezi*, but much larger," the flowers being about 3 in. across. They "have a disagreeable smell like apples beginning to ferment." This species was found by *Pöppig* in dry thickets in Peru,

“always growing in the ground, and never upon trees.” (*B. M. R.*, Dec., No. 174.)

+ *M. foveàta* Lindl. Flowers of a straw colour, with a faint, not unpleasant, smell. From Demerara, by Messrs. Loddiges. (*B. M. R.*, 1839, No. 2.)

+ *Caelogyne Wallichiana* Lindl. This curious species has also been sent home by Mr. Gibson. “It has large, handsome, scentless, deep rose-coloured flowers, growing close to the ground, from within some hard tuberculated sheaths proceeding from the base of depressed, flask-shaped, green and purple speckled pseudo-bulbs. In its native country this and allied species cover the ground with a pavement of their curious stems, which wither up in the dry season, but change into a brilliant carpet of rosy flowers on the approach of rain.” (*B. M. R.*, Nov., No. 157.)

+ *C. ovàlis* Lindl. Some dried specimens of this species in Dr. Wallich’s Indian herbarium, Dr. Lindley observes, he mistook, some years since, for *C. fimbriata*: but lately a plant sent by Dr. Wallich to Messrs. Loddiges has flowered, which proves to be different. (*B. M. R.*, Dec., No. 171.)

+ *Pleurothállis muscöidea* Lindl. This is the smallest orchidaceous plant known. “It has no stem, the leaves are two lines and a half long; and the peduncle is as fine as a hair, and about four lines long.” The colours of the flower are purple and orange.” (*B. M. R.*, Dec., No. 165.)

+ *P. stenopétala* G. Lodd. A pretty species, with pale green and crimson flowers, a native of Brazil, “very near *P. sclerophýlla*.” (*B. M. R.*, Dec., No. 182.)

+ *P. pectinàta* Lindl. This is a very curious species, resembling *P. prolifera* in habit, a native of Rio Janeiro. “The flowers are sea-green, with a few deep purple spots at the base of the labellum.” (*B. M. R.*, Jan. 1839, No. 1.)

+ *P. strupifòlia* Lindl. A native of Rio. “The leaves are like leathern thongs, and full 18 in. long. The flowers are dull purple and white.” (*B. M. R.*, Jan. 1839, No. 3.)

*Quekétia microscópica* Lindl. “A very singular little plant, with the habit of a *Pleurothállis*, and the pollen masses of a vandeous orchidacea; more nearly allied to *Rodriguèzia* than to any thing else, but quite different in habit.” The plant is only a few inches high, and has no beauty unless examined with a microscope. It forms the type of a new genus, named by Dr. Lindley in honour of E. J. Quekett, Esq., F.L.S.; an excellent botanical observer, and one of our most skilful vegetable anatomists. (*B. M. R.*, Jan. 1839, No. 6.)

+ *Lælia úlbida* Lindl. The flowers are white, 2 in. across, and sweet-scented, with a yellow streak down the centre of the lip, and a few crimson dots at its base. It is a native of the environs of Oaxaca, whence it was imported by Mr. Bateman. It

is of easy cultivation, and the most free flowering individual of the genus. (*B. M. R.*, Jan. 1839, No. 4.)

+ *Epidéndron calamàrium* Lindl. "A Brazilian species, allied to *E. fràgrans*, imported by Messrs. Loddiges, with whom it flowered in October" last. In has "yellowish green flowers, with five small violet-coloured spots at the base of the lip." (*B. M. R.*, Nov., No. 163.)

+ *Satýrium càndidum* Lindl. "One of the terrestrial Orchidæcæ of the Cape of Good Hope, concerning which so little is as yet known in Europe. It was brought home by Sir John Herschel, with whom it flowered in Hanover Terrace, Regent's Park, in October, 1838; its flowers are a pure white, and emit a most delightful aromatic fragrance." (*B. M. R.*, Nov., No. 153.)

+ *S. papillòsum* Lindl. "The flowers are of a deep clear rose colour, melting into white, and richly spotted with purple in the throat: they smell like sweet vernal grass." This species was brought over in a growing state in a box of Cape earth. (*B. M. R.*, Nov., No. 154.)

+ *Notýlia incúrva* Lindl. The flowers are of a pale straw colour, and very large. "Messrs. Loddiges obtained it from Trinidad." (*B. M. R.*, Dec., No. 167.)

+ *N. Bárkeri* Lindl. "Very like the last, but the flowers are smaller and yellower." Introduced from Mexico by Mr. Barker in 1837. (*B. M. R.*, Dec. No. 168.)

+ *N. ténuis* Lindl. This species was received by Messrs. Loddiges from Demerara. Its flowers are smaller than those of the preceding kind. (*B. M. R.*, Dec., No. 169.)

+ *N. micrántha* Lindl. This is also a native of Demerara, and its flowers are not more than half the size of the last. They are of a pale green, with a yellowish lip; and the petals have no spots. (*B. M. R.*, Dec., No. 170.)

+ *Mormòdes pardina* Bate. Discovered by Baron Karwinsky in Oaxaca. It is of a robust habit, with primrose flowers spotted with reddish purple, which "exhale a most delightful perfume." It flowered with Mr. Bateman at Knypersley in July last. Mr. Barker has a self-coloured variety of this species. (*B. M. R.*, Dec., No. 176.)

The *Cyclòsia maculàta* of Klotsch Dr. Lindley considers to be the same as this species.

+ *Bifrenària ? longicòrnis* Lindl. Dr. Lindley considers it doubtful whether this plant can be referred to *Bifrenària*, as "the lateral sepals are extended into a long clavate spur; and there are two glands, as well as two caudiculæ, to the pollen masses. Its relationship to *B. aurantiaca* is, however, such as to make us unwilling to separate it at present. The flowers are orange, spotted with brown; and in a raceme very like that of the species just mentioned." (*B. M. R.*, Dec., No. 177.)

+ *Trichocéntron iridifòlium* G. Loddiges. "A small species,

with pale yellow flowers, having the lip streaked with a darker yellow." A native of Demerara. (*B. M. R.*, Dec., No. 178.)

+ *Æthèria occulta* Lindl.; *Goodyèra occulta* Thouars; *Platylipsis goodyeroides* A. Rich. "A specimen of this plant, obtained from the Mauritius, has flowered with Messrs. Loddiges. It proves to belong to the genus *Æthèria* of Blume." (*B. M. R.*, Dec., No. 179.)

+ *Liparis pendula* Lindl. Nearly allied to *L. longipes*. A native of India, whence it was obtained by Messrs. Loddiges. (*B. M. R.*, Dec., No. 180.)

+ *Ionopsis tères* Lindl. "A curious little plant, with delicate lilac-striped flowers." (*B. M. R.*, Dec., No. 181.)

+ *Bolbophyllum cupreum* Lindl. A native of Manilla. "The flowers are copper-coloured, and have a smell extremely like that of valerian root." (*B. M. R.*, Dec., No. 183.)

2562. BRASAVOLA

+ *Martiana* Lindl. Dr. Martius's £ ☒ cu 1 o W.Y Brazil ... D stones and rocks Bot. [reg. 1839, 5.

This species was described by Dr. Lindley, when speaking of *Brasavola cordata*, *Bot. Reg.* t. 1914., from a dried specimen in the herbarium of Dr. Von Martius; but it has since been imported by Messrs. Loddiges from Berbice. It has a fringed labellum, and is handsomer than most of the other species, though it is still more curious than beautiful. It seems to delight in a rough and stony soil, not too retentive of moisture; and this is readily imitated in pots, by mixing rough peat with broken bricks or small stones. (*Bot. Reg.*, Jan.)

#### *Musaceæ.*

745. HELICO'NIA

bicolor *Bot.* two-coloured £ ☒ or 3 W.C Brazil ? 1828. D p.l Botanist, no. 101.

This truly splendid plant has white flowers, with bright crimson bracteas and flower stems. The white flowers have a wax-like appearance, like those of the flowers of the white camellias; and they are slightly tinged with green at their extremities. The leaves resemble those of the bananas. "Although the growth of the plants is slow, and they, therefore, occupy a valuable place in the stove for many years before they flower, yet they fully repay the cultivator's patience and care, by the great beauty and long duration of their spikes of flowers." (*Botanist*, Jan.)

#### *Hæmodoracæ.*

943. ANIGOZANTHUS 7657 flávida var. +bicolor Lindl. in *Bot. Reg.*, 2d ser., 64.

A scarlet and green variety of *Anigozanthus flávida*. (*Bot. Reg.*, Dec.)

coccinea ? Lindl. scarlet £ ☒ or 5 jn.au C Swan River 1837. D p.l Paxt. mag. of [bot. v. 271.

This is one of the handsomest species of a very extraordinary genus. The flowers are of a very peculiar colour, between scarlet and crimson, with a tinge of green at the extremity. The leaves are of deep green, linear lanceolate, and from a foot to

18 in. long. The flower-stems are 4 or 5 feet high, and branch most luxuriantly, forming a head of flowers a foot or more in dimension. Mr. Paxton thinks that it might be planted in the open ground, where it would "form a most striking object in the summer season, and might easily be removed in a pot to the green-house in winter." It is propagated either by seeds, or division of the root. (*Part. Mag. of Bot.*, Jan.)

*Polystachya lutèola* Hook. Exot. Fl. t. 105.; syn. *Dendrobium polysticton* Swartz. This plant, Dr. Lindley observes, is certainly from the West Indies; and it is by mistake, that the specimen of it in the Liverpool Botanic Garden is said to be from the East Indies, and to have been received from Dr. Wallich, as it does not appear among any of the doctor's collections. (*B. M. R.*, Oct., No. 143.)

+ *P. zeylanica* Lindl.; syn. *Dendrobium polystachyum* Thouars *Orch. Afr.* t. 85. In both this plant and *P. lutèola*, Dr. Lindley has observed that the disk of the labellum is covered with a fine frost-like mealiness, which is removed by the slightest touch, and which is "a curious modification of the hairs found in other plants. When undisturbed it consists of threads with egg-shaped joints, which are filled with air." The slightest touch destroys the cohesion between these joints, "so that when they are placed on the field of the microscope, the latter appears as if covered with the eggs of some insect; it is only when they are removed from the labellum with great care, that their real articulated structure, and their analogy with such hairs as those of *tradescantia*, is made out." (*B. M. R.*, Oct., No. 144.)

+ *Trigonidium Egertonianum* Bate. *in litt.* A very distinct species, a native of the Bay of Dulce in Honduras, where it was discovered by G. U. Skinner, Esq. "It approaches nearest to *T. obtusum*, from which its acute petals, and narrow leaves (frequently fully a foot and a half long), and clustered pseudo-bulbs abundantly distinguish it. Its flowers are of a pale liver colour, dashed and veined with brown, and from a resemblance which they are supposed to bear to a 'Dragon's mouth,' the plant has received that appellation from the inhabitants of Honduras." (*B. M. R.*, Oct., No. 135.)

+ *T. acuminatum* Bate. *in litt.* "Found in Demerara by Mr. Colley and other collectors." The flowers are straw-coloured, elegantly pencilled on the inside with a rich brown. (*B. M. R.*, Oct., No. 136.)

#### *Amaryllidaceæ.*

+ *Agave Saponaria* Lindl. Found by Mr. Skinner in Peru, where it is used as a soap plant; "its thick succulent root possessing the property of forming a lather with water. It has dingy purple flowers, and is nearly allied to *A. lùrida*." (*B. M. R.*, Oct., No. 141.)

## \*CHORETIS

\*glauca Herb. glaucous ♂ □ or 1 au W Mexico 1837. O s Flor. cab. 2. p. 101.

This is a very beautiful bulbous-rooted plant, with a flower greatly resembling that of *Ismène*, from which genus *Choritis* has been lately divided by the Hon. and Rev. William Herbert. *C. glauca* is a native of Oaxaca in Mexico, whence it was imported by George Barker, Esq., of Springfield, near Birmingham. (*Flor. Cab.*, Sept.)

+ *Urceolina péndula* Herb. "This remarkable plant flowered for the first time at Spofforth, in June last, having been kept dry in the green-house during the winter." It requires a strong rich loam; and, as it is a native of shady woods on the Peruvian Andes, it seems to suffer by exposure to the sun. The flowers are yellow and green. (*B. M. R.*, Nov., No. 151.)

*Liliææ.*

1016. *LYLIUM* 30170 speciosum var. punctatum.  
Synonyme: *L. lancifolium roseum* Paxl. *Mag. of Bot.* 5. 267.

*Melanthææ.*

9163. *Meréndera caucàsia* Bieb., *Bot. Mag.* 3690. This elegant little bulb produced its flowers (and leaves at the same time) in the month of May, in the Glasgow Botanic Garden, under a glass frame. In its native country (Caucasus) it blooms in very early spring. The flower is very pale lilac, with a shade of pink. (*Bot. Mag.*, Nov.)

1030. *ZIGADE'NUS* glaucus Nutt., *Bot. Reg.* 2d ser. 67.  
Synonyme: 29339 *élegans* Ph. & Nutt.

Dr. Lindley states that this is the species which was supposed by Douglas to be the *Z. élegans* of Pursh. (*Bot. Reg.*, Dec.)

*Commelinææ.*

*Tradescántia iridescens* Lindl. "This lovely species of *Tradescántia* is a native of the neighbourhood of the Real del Monte Mines in Mexico, from whence roots of it were forwarded in the spring of 1838, by Mr. John Rule, to Sir Charles Lemon, Bart. M.P., in whose collection it flowered in June. . . . It has hitherto been kept in a warm green-house, but it will probably endure the open air, and ultimately become a half-hardy herbaceous plant." (*B. M. R.*, No. 160.)

*Juncææ.*

2776. *XEROTES* 24265 longifolia R. B., *Bot. Reg.*, 1839, 3.  
Synonyme: *Lomandra longifolia* Lab. *Nov. Holl.*, i. 92. t. 119.

The plant figured in the *Botanic Register* has the leaves smooth at their margins, and not rough, as described by Dr. Brown. It is a native of Van Diemen's Land. "It is a plant of no beauty," Dr. Lindley observes, "but its leaves are so hard and tough, that it deserves enquiry whether they will not yield a fibre capable of being advantageously manufactured into cordage. I know nothing which, in the manufactured state, promises better,



by the powerful resistance offered to the force employed to break it." It is a herbaceous plant, and in this country it is half-hardy, and will grow in any soil. (*Bot. Reg.*, Jan.)

---

ART. VI. *On the Culture of Cáctææ*. By Dr. PFEIFFER of Cassel. Translated from the "*Garten Zeitung*" by A. KELLERMANN.

[Mr. Kellermann is a native of Dresden; and it was his father's intention that he should be brought up to the medical profession; but when he attended Dr. Reichenbach's lectures on botany in the Botanic Garden at Dresden, he was so much struck with the collection of cactuses there, that he determined on becoming a gardener; and for that purpose got himself engaged as an assistant in the Dresden Garden. Having remained there some years, he next visited the principal gardening establishments in Germany, Belgium, &c. He was afterwards engaged by Mr. Forbes, and was fourteen months a journeyman in the gardens at Woburn Abbey. After this he went to Scotland, and was for several months in the Edinburgh Botanic Garden, under Mr. M'Nab, whence he was engaged as assistant curator to the Edinburgh Botanical Society, where he now (Nov. 1838) is. In March next, he comes to London, having been engaged by Messrs. Rollisson of Tooting, to go to South America, as their botanical collector.]

§ 1. THE culture of *Cáctææ* in our climate [Germany] being both uniform and simple, and these plants requiring but little trouble, they are preferably adapted for growing in rooms. Except a few, particularly the melocactuses, they do not require the temperature of a stove, but do quite well, even during winter, in the windows of a light room, with a southern aspect, provided they are kept dry, and the temperature does not sink below  $+2^{\circ}$  or  $3^{\circ}$  Réaumur ( $36^{\circ}$  or  $38^{\circ}$  Fahrenheit). Sometimes, when they are somewhat hardened by previous treatment, they will even stand some degrees below zero Réaumur. ( $32^{\circ}$  Fahrenh.) The better sorts, however, should not be exposed to such a change, as they are found to succeed better when the temperature is kept as equal as possible; except during night, when the temperature may be allowed to decrease in a natural proportion. Many species, and in particular those which are natives of the colder and more elevated regions of Mexico, Brazil, and Chile, thrive best in a lower temperature, and can be wintered very well in an orange-house; when, on the other hand, many of our oldest species, which were first imported from the much warmer climate of the West Indies, require a greater heat.

§ 2. To grow and see *Cáctææ* in their natural luxuriance, it is a matter of the greatest importance that they should be exposed to the open air throughout the summer; as by this treatment alone most of the mammillarias, echinocactuses, cereuses, and opuntias, will attain the same appearance that they present in their native country. They will, no doubt, grow faster, and become larger in a stove; but then they are always more slender, weak, and furnished with comparatively few, thin, and short spines; so that they present little or no appearance in common with others of the same sort grown in the open air. (See *Garten Zeitung*, No. 2. for 1835.)

§ 3. Later experience has even taught that it is of great benefit to the above-mentioned genera, that they should be grown throughout the summer entirely in the open ground, and in suitable mould. From this situation, they should be repotted again early in the autumn, so as to allow them to make a sufficiency of young roots before winter. By this proceeding, particularly when the cactus pits are covered with lights, and plenty of air admitted, many species have been brought for some years past to such a vigorous growth, that we are now possessed of specimens of a size and beauty never known before. In some places mere sand pits, with lights, have been used for the same purpose.

not without success; in which pits cuttings especially are in no danger of rotting, but root very soon, and keep on growing vigorously. Even for newly imported specimens of extraordinary size, this treatment seems to be well adapted; so much so, that large melocactuses, most of which were lost under the former management, are now found, in a short time, to resume a healthy growth. (See § 14.)

§ 4. But very little seems to depend on the compost used for *Cactææ*, provided that the general rule be attended to, not to use any too heavy or rich mould, or such as is manured with animal substances. A mixture of sifted well decomposed frame dung, and garden mould, with a third of river sand and riddled lime rubbish, has proved, in my experience, most suitable for all the *Cactææ*. Nevertheless, we often find that *Cereus speciosissimus*, *phyllanthoides*, and *flagelliformis*, potted in any soil, do very well, and flower. Mr. Haage of Erford uses a great deal of brickdust mixed with the soil; and, apparently, with good success.

§ 5. Most of the *Cactææ* have but few and small roots, compared with their size; upon which account it is advisable to give them very small, particularly not too deep, pots; in which a good draining is produced by putting in crocks and pieces of lime or flint stones, to the depth of an inch; so that the water cannot stagnate, and become hurtful to the root. The tender roots, or spongioles, like to adhere to these drainings, and even to penetrate such as are of a porous structure (like the chalk stone generally used with us). Pots made of china, or glazed, are by no means to be used, as the plants will soon become sick in them, and die.

§ 6. The general rule for repotting *Cactææ* is, not to do it, unless absolutely necessary, in the latter part of the autumn, or in the winter. They require repotting: first, when the whole pot is filled with a dense ball of roots; secondly, when it happens that the roots grow through the bottom of the pot, and that the surface of the soil becomes impervious to water, and is covered with moss; thirdly, when we observe that insects or worms have penetrated the soil (which discovers itself by a peculiar caking together of the mould into small lumps); and lastly, when a plant, healthy before, stops growing for a long period, the reason of which is generally the exhausted state of the mould.

§ 7. It is always best to free the roots carefully and entirely from the mould, so that they may be all loose and naked; and to take all the dry fibres off; then to hold the plant at a right height and position over a somewhat larger pot, with small pieces of lime in the bottom, and to keep on powdering in from all sides fresh and loose, but not quite dry mould, until the pot is full. Shaking the pot several times against the bench will make the mould set, and get somewhat firmer. By no means, however, should the mould be pressed close with the fingers, as, if it gets too firm, the tender roots break off, and give occasion to rotting.

§ 8. The watering during winter must be done with the utmost care, regulating the repetition and proportion of its application according to the average temperature in which the plants are kept. Cactuses may be watered in a regularly heated stove every second or third day, without any danger; whenever the soil is not only dry on the surface, but completely so throughout, which is easily ascertained by the weight of the pot. On the contrary, when *Cactææ* are wintered in a but moderately warm place, and particularly in an irregularly heated room, it becomes very necessary to keep them almost quite dry, and to water them at the utmost once a fortnight, to prevent their shrinking, and to enable them to recover so much the faster in the spring; and even to leave off syringing the plants, both in the stove and rooms, during winter, seems to be the best practice.

§ 9. As soon as summer approaches, and the plants begin to thrive, they should not want nourishment. They then require a good supply of water; and in sunny weather they must be watered and syringed abundantly every day, which will be done best in the evenings, when the rays of the sun have nearly or entirely left them. A very suitable way to furnish the plants with water, (which, however, will not be easily accomplished in large collections), I think,

is, to hold the pot up to the brim in a deep vessel filled with not too cold water, until no more bubbles rise up from it. This proceeding may be made use of to great advantage, immediately after having repotted any sort of *Cactææ*. In dull weather, however, this soaking through of the mould is not advisable, although all the superfluous water should run off immediately from below: but it is of great benefit in hot weather, when it is sufficient for several days, as no more watering is required until the soil is again dry.

§ 10. In respect to the winged cereuses, the rhipsalises, and pereskias, they can withstand much more moisture than any others of the *Cactææ*, and require, for blooming, a strong heat, with comparatively little sunshine. This is following Nature herself, as they live in their native country in damp shady forests, mostly as epiphytes, when melocactuses, echinocactuses, cereuses, and opuntias, are preferably found on the most sunny places of the coasts, and in hot, sunburnt, and stony plains.

§ 11. The art of propagating *Cactææ* has made such rapid progress in modern times, that sorts of which there had only been single specimens in few collections for many years, are now propagated, and will soon be obtainable by amateurs. The melocactuses only cannot be subjected to the common rule (see § 12.), and are almost always propagated by seed, whereby it sometimes happens that degenerations take place. All other *Cactææ* may be cut in two, at the proper season, without danger; and, when potted with care, it is generally the case that the cut off piece forms a better specimen than the mutilated one was. Mammillarias and echinocactuses, scarcely the size of a walnut, are fit for making cuttings, and grow with more ease and certainty at this time: in the same way, even the oldest plants succeed; for example, cereuses with an axis of wood from one to two inches in diameter; in short, it is a generally practicable proceeding, and yet requires some care. Echinocactuses and cereuses shoot out generally from the knots (where the spines are): mammillarias, on the contrary, shoot from between the teats, sometimes out of the teats themselves. These shoots may be taken off very soon; and the smaller they are, the sooner they will be found to root. The same way of propagating may be adopted for *lepismiums*, *rhipsalises*, and *pereskias*. *Epiphyllums*, *hariotas*, and *opuntias* are easily propagated, by separating and taking off one or two articulations in the joints.

§ 12. Each part of a *Cactus* intended to form a new plant, whether it be a cut off head, or a taken off shoot, must, according to the different state of the weather, lie from one to eight days exposed, if possible, to the sun, to dry the cut completely. I never found it necessary to powder with coal-powder or brickdust, and but very seldom lost a cutting or taken off head, except when the weather, immediately after cutting, became dull and wet for a long time. I even cannot believe that the striking of the cuttings will be advanced by plunging the pots into a hot-pit; on the contrary, the surest method appears to me to be to expose the newly potted cuttings to a most concentrated sun-heat, by placing them under a sloping light of the green-house, and it does no harm, although the pots get so hot that they can scarcely be touched.

§ 13. When the cuttings are duly dry, they must be potted into as small pots as possible; and the same cautions I mentioned when speaking of repotting well observed. Some put cuttings into somewhat moist soil, and let them stand for a fortnight without watering; but I always plunge the pots of my cuttings, immediately after potting, once into water, and keep them in it till they are completely saturated; after which I let them stand for twenty-four hours in the shade. I then bring them to the sun, not watering at all till all the mould is completely dry. Which of these methods is the better, I do not know; the first may, perhaps, be the surest in doubtful weather, and an advanced season; but the latter, at all events, will lead soonest to the purpose. Besides, I have tried, as an experiment, to take cuttings of several *Cactææ* last winter. I potted them about Christmas, and, after a good plunging into water, placed the pots upon a heated stove, where they soon got dry; and, by a good daily supply of water, began to strike roots in the course of about a week.

§ 14. It is of great importance for imported *Cáctææ*, to cut off all the roots, though healthy and strong-looking; and to clear off whatever is withered and soft (about the plant itself), and cannot be loosened with the fingers, with a sharp knife, without bruising. They must then be left lying for some time, and the cut exposed as much as possible to the sun. When these precautionary measures are not taken, the plant will get rotten from below, and must be put into greater danger by cutting in the healthy flesh, than it can incur when put into the soil with a dry and healed up stump: and, although it may happen that no rotting takes place, it is sometimes the case that the plants will stand for several years without growing in the least; it being more difficult for young roots to shoot out from the remaining portions of the old roots, than out of the body of the plant itself.

§ 15. To graft *Cáctææ* is not very difficult; and, though it may appear a mere play, it is not quite that, as there are many sorts of this kind of plants which may be more easily flowered by this method than by any other; and if we continue these experiments, we may, perhaps, obtain many new flowers. We succeed best in grafting joints of *Epiphýllum truncátum*, *E. Altensteíni*, or even *Cereus phyllanthóides*, upon the stem of *Opúntia brasiliénsis*, the top of which has been cut off; and we get, by such means, plants of surprising beauty, which distinguish themselves by their luxuriant growth and profusion of flowers. Even slender branches of several cereuses will grow easily upon fleshy opuntias, and the process itself is quite a simple one. Take the cutting off somewhat pointed on the lower end, and shove it, freshly cut, into the cut or hole of the plant upon which it is to be grafted; and wind a woollen thread not too firmly round it; or, if that should not be easily managed, close the place by plastering grafting wax over it. When it succeeds, so close a union soon takes place, that the graft seems to be a part of the plant itself. The growing of the graft, however, is no proof of the success of the operation, for it often happens that, notwithstanding its growth, no such joining has taken place; and the consequence is, that sooner or later the graft withers, though sometimes not before one or two years.

§ 16. The propagation of *Cáctææ* by seed is for many sorts of great value to us; and whenever we have seed, we are pretty sure to succeed. We annually get ripe seed in abundance of a great many sorts, without the least trouble; as of *Mammillária pusilla* and *símplex*, *Echinocáctus Ottónis*, *Cereus flagellifórmis*, and a great many of the opuntias. But these, unfortunately, are sorts which, to grow slowly from seed, is of but little or no interest to us, because we can get them much faster by cuttings in any number we choose. Seeds of some sorts we get only by a careful and artificial impregnation. For this purpose, we take the pollen from a completely unfolded flower with a soft and clean camel-hair brush, and brush it, without force, either upon the stigma of the same flower, or, when it is wished to produce hybrids, upon that of another sort. By these means, we very often get fruits with ripe seeds, fit for sowing. Besides, we are sometimes so lucky as to find ripe fruits on newly imported specimens; and it is of great consequence, that persons who get such plants from their native countries should carefully examine the living ones of new forms, as well as those that happen to be dead, to see whether they can find any seed on or about them. It has already happened that some unique specimens in Europe have been saved by carefully collecting and sowing both the remainders of the plants, and the dust and dregs of the box.

§ 17. For sowing, small pots are used, filled with a loose sandy mould, watered previously to sowing; the seed is then strewed over the surface, and either sparingly covered or not with some very fine mould or sand; then covered with a pane of glass, and placed either in a hot frame, or below a sloping light, in a warm situation. Cactus seeds retain their vitality for several years, and spring generally in about ten or fourteen days after sowing. As soon as the young plants appear, they must be secured against too burning heat of the sun, and potted as soon as possible, either singly or from three to four together, in very small pots. The most dangerous enemies to them are

the woodlice (*Oniscus Asellus*), which nibble very often a whole sowing, and against which the seedlings must be guarded with the utmost care.

§ 18. Some other dangerous enemies to *Cactææ* are the following:—

1. The red spider, which, when in abundance, can destroy the whole surface of the plant; and if not kill it, at least make it sickly. It generally ceases its ravages in the open air, but not always; and the only remedy against it seems to be to strew it close over with sulphur powder, which will smother the insect; and the sulphur will not injure the plant, if removed some days after by washing or syringing.

2. The bug (*Coccus*), a white and soft insect, is likewise very dangerous to the plants, and I know no other remedy than that of picking it off carefully.

3. The cochineal (*Kermes*), is kept very often on purpose for curiosity's sake, on single opuntias. This insect increases sometimes so rapidly, that it spreads itself over all the surrounding *Cactææ*, cereuses in particular, and injures them.

4. The small scale, which is very abundant on opuntias and cereuses, particularly on some of the winged kinds of the latter. This must be removed repeatedly with a soft brush, so as to kill even the young ones, which are often so small as scarcely to be seen.

5. The mice are often more hurtful enemies to the *Cactææ* than any of the preceding, and are not afraid even of the most spiny kinds. They have destroyed me many a fine specimen, and even an *Opuntia sulphurea*, which has very dense spines. The place where *Cactææ* have to stand must, therefore, be well secured against mice. Even rats and bats attack them sometimes.

## REVIEWS.

ART. I. *The Little English Flora; or, Botanical and popular Account of all our common Field Flowers, with Engravings on Steel of every Species.* By G. W. Francis, Author of the "Analysis of British Ferns," &c. 12mo, pp. 174, 14 plates engraved on steel.

MR. FRANCIS is a young botanist, not more remarkable for his love of the science and his knowledge of British plants, than for his eagerness to communicate his enthusiasm and his knowledge to others. As an artist, he is also a very remarkable person, having engraved the whole of the plates for this work, as well as those for his *Analysis of British Ferns*, himself, and having displayed in these engravings so much of the characters of the plants as almost to entitle him to be ranked with Sowerby. Mr. Francis's object in the present work is—

"First, to invite the young to the examination of the 'Flowers of the Field,' by pointing out the beauties they are likely everywhere to meet with; that thus an additional charm may be added to their rambles over the meads and commons. Secondly, to induce a love for the science itself, by showing that it is easy of acquirement, and that it yields instruction and delight, not merely in our after progress, but even from our first commencement of its study." (*Pref.*)

He has endeavoured to accomplish these objects—

"By giving a plain, scientific, and popular description of all our common wild plants, accompanying these with accurate steel engravings of every species; and introducing such anecdotes, remarks, and extracts, as the various

subjects have suggested. . . . The work is introduced by an account of the Linnæan system, and the rules for collecting, drying, and naming plants in general, accompanied with a full glossary of all the terms employed; and terminates with three indexes, and an appendix of the more difficult tribes of flowering plants, and of all the cryptogamic orders.

“The plates [figures] are necessarily very small; but this was unavoidable, as will be apparent when it is considered that there are 280 plants represented; and to have engraved them on a larger scale would have made the work too expensive for general circulation.” (*Pref.*)

The figures, considering their wonderfully small size, no fewer than 20 being got into a space not quite 3 in. by  $5\frac{1}{2}$  in., will be readily recognised for what they are intended to represent, by those who already know the plants; and they will even be of considerable assistance to others.

The book is dedicated to the “Young Ladies of England;” to whom, and to all beginners of whatever description, we can most safely and strongly recommend it.

---

ART. II. *The Ladies' Flower-Garden of Ornamental Annuals.* By Mrs. Loudon. 4to, pp. 16, exclusive of four pages of Introduction, and three plates, containing 14 coloured figures of plants of the natural size. To be continued monthly, and completed in 15 or 16 Numbers, at 2s. 6d. each. London, 1839.

THOUGH the production of a member of our own family, we think it but justice to state that this is an elegant work, and one which will be found not more beautiful than it is useful. There is no class of flowers that addresses itself so universally to the possessors of gardens as hardy annuals, since the seed may be sown, and the plants displayed in all their beauty in from five to eight months.

“The culture of annuals has two great advantages over the culture of all other flowers whatever. In the first place, it is attended with less expense than any other description of flower culture; and in the second, all the enjoyment of which it is susceptible is obtained within the compass of six or eight months. Bulbous or tuberous rooted flowers, like annuals, produce their blossoms in the first year; but they are attended with an enormously increased expense. Perennial herbaceous flowers are never in perfection till the second year; and, like bulbs, can only be beneficially purchased by such as anticipate retaining the occupation of their garden for several years in succession. The seeds of annual flowers, on the other hand, cost a mere trifle; and the expense of stirring the soil, sowing them, and thinning them when they come up, is also very little; while the effect produced is as great or greater than that of many bulbs or tubers, and most perennials. The flower of a choice hyacinth, the bulb of which will cost five or six shillings before planting, is not much more beautiful than that of a double rocket larkspur, which may be reared to perfection in three months, from a seed which will cost about the fiftieth part of a penny. Annual flowers, therefore, are, above all others, suitable for the gardens of suburban residences which are hired for not more than a year; while they are equally fit for decorating all other gardens whatever, and pecu-

liarily so for such as are defective in soil, situation, or exposure to the sun, as is amply shown in the *Suburban Gardener*.

“Mr. Paxton, the chief manager of the gardens of His Grace the Duke of Devonshire, in a late number of his excellent *Magazine of Botany*, observes : ‘Considered as the principal ornaments of the flower-garden throughout the most delightful period of the year, and during a considerable portion of it as the most interesting features in the green-house, annual plants have great claims to our attention, and should be very extensively cultivated in every pleasure-garden. But the vast number and variety of sorts that are now known in our collections, the whole of which it is almost impossible to introduce into even the most extensive gardens, renders necessary a judicious selection of the best kinds, in order to compensate for any deficiency in number or variety, by the superior beauty of those which are admitted.’ Such a selection it is my object to offer to the public in the following pages.” (*Introd.*, p. ii.)

The arrangement of the work is according to the natural system ; and an important feature in the plan is, that a number of species are grouped together in the same plate ; so that each number will contain from 12 to 20 figures of the natural size. Had these figures been given on separate 8vo plates, instead of 2s. 6d., they would have cost 7s. or 8s. There is another advantage of having them grouped, which is, that the difference between species nearly alike is more easily detected. The letter-press is ample, being at the rate of  $5\frac{1}{2}$  4to pages to each plate. Every species is described scientifically and popularly, with the geography, history, properties and uses, culture, and, in short, everything worth knowing of the plant. (p. iii.) The culture is given at length ; and great part of the information under this head will be original, being communicated by various gardeners, eminent for their success in the culture of annuals. In short, there is not a cheaper, or more useful, or, indeed, a more elegant, botanical and horticultural work in the course of publication.

We cannot conclude this notice without again referring to the plates. The subjects are drawn from nature by, or under the superintendence of, the same accomplished artist who superintends the plates of the *Floral Cabinet* ; and they are so delicately drawn on zinc, and so beautifully and artistically coloured, that were it not for the engraved names at the bottom of the plate, each impression might pass for an original drawing. The plate of larkspurs in this first number, is not, we believe, to be equalled in any botanical publication whatever ; and we may affirm the same of the plate of nigellas. These plates, it may truly be said, have been got up regardless of expense ; but such is their excellence, and the usefulness of the work, that we have no doubt it will amply repay the very spirited publisher ; who, indeed, from the success which has attended the *Floral Cabinet* since he became its publisher, must be aware that the public are not slow to appreciate excellence, when it is combined with cheapness.

It is no small recommendation to the *Ladies' Flower-Garden*,

that it will be finished in a definite period, and for a definite price; and that it will form a volume, the mere turning over of which on the drawingroom table will render even those who have no garden familiar with the flowers in most general cultivation in the gardens of their friends. As a drawing-book for young ladies to copy from, the work is unrivalled.

---

ART. III. *The Botanical Periodicals.*

WITHIN these few years a change has been effected in our botanical periodicals, which was first begun by Mr. Maund. We allude to the additional matter, of a miscellaneous nature, now given at the end, and in one instance, at both the end and the beginning, of the monthly numbers of these works. Thus, in Maund's *Botanic Garden*, we have at the end, the Auctarium; in his *Botanist*, large paper edition, we have at the beginning of each number a leaf of a Guide or Introduction to Botany; and at the end, a leaf of a Dictionary or Glossary of botanic terms, both written, as it is understood, by Professor Henslow. In the *Floral Cabinet*, we have, at the end of each number, an enumeration of the plants figured in the *Botanical Magazine* and the *Botanical Register*; and in addition, three or four pages of articles on culture, or on vegetable physiology. In Paxton's *Magazine of Botany*, we have at the end of each number similar lists and articles. With the *Botanical Magazine*, we had, till lately, the Companion, which was an excellent collection of botanical papers of popular and scientific interest; and, lastly, we have had, since the commencement of 1838, an Appendix to the *Botanical Register*, consisting, for the last year, of short descriptions of no fewer than 183 plants, the greater part of which are new. The *Botanical Register* for the present year has the plan of its appendix enlarged, and entitled a Monthly Chronicle of Botanical and Horticultural News. In this Monthly Chronicle, besides short descriptions of new plants, there are Reviews of Books, and extracts from scarce and valuable printed papers.

The effect of all these additions to the plates and descriptions, which hitherto constituted the whole matter of the botanical periodicals, is to render them more interesting, on account of their containing a greater quantity of readable matter; and in this point of view they must tend greatly to spread botanical and horticultural knowledge and taste. The only botanical periodical at present that is without one of these appendixes is the *Botanical Magazine*; and one object that we have in view in this notice is, if possible, to induce Dr. Hooker to recommence his Companion, in order, as it were, to render that father of the botanical periodicals on a par in point of popularity with its offspring. As all these appendixes are paged separately from the plates and their descriptions, they are calcu-



lated for being taken out and bound up by themselves; otherwise, some might consider them rather an incumbrance in a work which, when once bound up, will be referred to principally on account of its plates.

In the Monthly Chronicle of the *Botanical Register* for January, besides short descriptions of seven new plants, which will be found included in the "Floricultural Notices" of our present Number, there are reviews of three books, viz.: Endlicher's *New Theory of Vegetable Fertilisation*, a pamphlet published in Vienna in 1838; Torrey and Gray's *Flora of North America*, vol. i. part i.; and of Dr. Perrine on *Tropical Plants*, from *Report*, No. 564., of the 25th Congress of the House of Representatives, pamphlet, pp. 99. These reviews contain some very interesting reading, and cannot fail to add to the circulation of the *Botanical Register*. Indeed, we know, of our own knowledge, that they have done so.

The Guide, or Introduction to Botany, of which one leaf is given with every number of the *Botanist*, and of which the 51st page appeared on January 1st, 1839, promises to be one of the most comprehensive introductions to every department of botanical knowledge that ever has been attempted in this country. It is illustrated with numerous very neatly executed woodcuts, most of them self-explained, exclusively of the text, which is calculated to save the superficial reader a good deal of trouble. The Dictionary, a leaf of which is given at the end of every number of the large edition of the *Botanist*, and also at the end of the small edition, will be as complete, in its way, as the Guide. No general Dictionary of Botanical Terms, we believe, exists, either in the English or Latin language, that is at all complete. Professor Henslow's Dictionary is intended to supply this deficiency, and promises well to do so. In it, Latin and English terms are very properly arranged in one alphabet, for they are now so mixed up in botanical descriptions, that it is difficult to separate them; but the Latin terms are distinguished by being in italics. The whole is illustrated with numerous woodcuts. The botanical descriptions of the *Botanist* were, it is understood, during the progress of the first volume, and part of the second, prepared by Dr. Robert Dickson, who, it is said, has been succeeded in this department by Mr. Bentham, the Secretary to the Horticultural Society, whose descriptions bear the signature of G. B.

## MISCELLANEOUS INTELLIGENCE.

### ART. I. *Domestic Notices.*

#### ENGLAND.

*THE Hurricane of Jan. 7.* uprooted, or otherwise destroyed, 3283 trees in the Earl of Derby's park, at Knowlesley, near Liverpool. — *I. H. S. Man-*

chester, Jan. 15. 1839. — It carried the spray of the sea as far as Leeds, a distance of eighty miles, covering the trees and plants, in Mr. Major's garden at Knostrop, with a white incrustation, quite salt to the taste. (*J. Major*, in *Leeds Intelligencer*, Jan. 12. 1839.)

*Rose Stock Impostors.* — The nurserymen about London are supplied with stocks for budding standard roses by country labourers, who grub them up in hedge-rows and coppices. When this is carelessly done, a sufficient length of main root is not taken up to be furnished with fibres; and, as the plant is not so likely to grow, and of course not so saleable without them, these fibres are sometimes artificially supplied by the hawkers. This is done by boring, or piercing, with a bradawl, a hole in the under side of that part of the root which generally forms an angle with the upright stem; and in that hole inserting a small piece of fibrous root. The nurseryman who is unaware of this practice never thinks of looking at the under side of the root; but, seeing the fibres hanging down, is satisfied that the stock will grow, and makes his purchase. We could not have believed that it would have been worth while in this country, where labour is so dear, to take so much trouble to falsify an article, which seldom brings more than a shilling a dozen, had not our neighbour, Mr. Hopgood, shown us some scores of fabricated roots that he had inadvertently purchased. Storch, in his *Picture of St. Petersburg*, mentions, that the forced asparagus heads, after they have been boiled, and the head or point of the shoot eaten off at the tables of the wealthy who are able to purchase such a luxury, are sold by the house servants to the peasants who frequent the streets; and that these persons find it answers their purpose to carve a new bud on the point of the shoot, and even to colour it, and in that state to sell it in bundles, disguised by a few real heads on the outside. This, however, is not so surprising in St. Petersburg, where the labourer lives on rye bread and quass, and does not require even a bed to sleep on, as the rose stock impostor is in London. — *Cond.*

*Glazenwood Nursery.* — I lately visited this nursery for the first time, and never was more surprised than to see the manner in which American shrubs thrive there without bog earth. The soil of the nursery is a yellow loam; and in it all sorts of rhododendrons, azaleas, and magnolias appear to thrive, I will not say, as well as if they were in peat, but I will say, sufficiently well for every useful and ornamental purpose. The foliage was most healthy, the wood ripened, and the flower-buds, formed for expansion next season, numerous and large. I can easily conceive that it must be a great advantage for gentlemen who have no peaty earth on their estates, and who will not go to the expense of purchasing any, to procure their American plants from Glazenwood; because these plants having been brought up, so to speak, in common soil, they cannot suffer anything like the check, when moved from common soil to common soil, that they would do if moved to common soil from peat earth. I was confirmed in this opinion by Mr. Curtis, who is justly proud of the appearance of his plants, and of the satisfaction which they give to his customers in districts where peat is unknown. — *T. B. Dec. 18. 1838.*

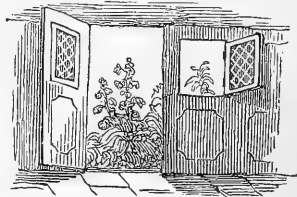
*Specimens of Wheat.* — The wheat you were kind enough to give me has been carefully kept separate, and sown, for the third time, in the middle of last October: I mean such of it as I considered worth preserving. Out of the fifty and odd parcels, I have only retained twenty-three, and these occupy two and a half acres. I and the gardener have hitherto attended to the main operations; viz. harvesting, threshing, and dressing. I had it very carefully dibbled and dropped, and have made a correct plan of the ground, and measurement of the several divisions. One half of the land has been subsoil ploughed; the substratum is a rubbly chalk. You will smile at my farming, when I tell you I do not occupy a single acre of land; but I live among good neighbours, one of whom has given me up as much as I want this year. In future, I must go upon a different plan, as my crop will increase far beyond the borrowing system. I ought to have near upon ten quarters next harvest.

It appears to me that the St. Helena wheat is about as good a variety as any I have. I had ten grains at first; and the quantity last sown was 12 pints, weighing 12 lb. 2 oz.: breadth of land dibbled was  $21\frac{7}{100}$  rods. — *Samuel Taylor, Stoke Ferry, Norfolk, Jan. 10. 1839.*

## ART. II. *Retrospective Criticism.*

*THE Encyclopædia of Cottage, Farm, and Villa Architecture and Furniture.*— I am so fully persuaded of the extensive usefulness of your publications, but more especially of your valuable *Encyclopædia of Cottage and Villa Architecture*, that I am desirous of calling your attention to a subject which is there but slightly touched upon; probably because it is not very interesting to Englishmen in their own country, although highly important to those who have left it. I allude to cottages and small villa residences adapted for the hundreds, we may almost say thousands, who are now settled in the different colonies of Australia, or who are on the point of making that country their home. The portable habitations you have so well described have been, I understand, most extensively adopted; yet these, of course, are but temporary dwellings: for, so soon as a settler is located upon his own land, he begins to think of building a house of more substantial materials. Such dwellings, as you well know, should be adapted, in all respects, to the nature of the climate; and hence it follows, that the styles and plans perfectly suited to the cold and comfortless atmosphere which pervades half the English year, are altogether inapplicable to the warm plains and sunny winters of Australia. If some of your numerous architectural correspondents would contribute their aid in this branch of their art, what a benefit they would confer upon the Anglo-Australians, and how much would they do towards introducing a chaste and appropriate style in their buildings. Having lived a good deal in tropical climates, a few hints, perhaps, might be useful on this head. Generally speaking, in England, we want warmth in our houses; there they want cold. Here, the light of heaven is taxed; there, we may use it as we like. Window glass, to be sure, must be had from England, and that is ruinously expensive: but the Portuguese in Brazil have a method in the construction of their windows highly curious; and, as I have never seen it used elsewhere, I will just pause to describe their plan. The windows of their country or villa cottages are always large, without any sashes, fixed or unfixed, but merely closed by two folding wooden shutters: each of these shutters, however, has a little window of its own, which is fixed in the wood, and composed of small diamond-shaped panes of glass. (*fig. 20.*) During the day, the shutters are invariably open, when the weather is fine (and it is hardly ever otherwise); but, in any heavy squall of rain, the shutters are closed, the little windows in them throwing sufficient light into the room for all ordinary purposes: the shower past, the shutters are again opened. By this plan, two great objects are gained: 1st, that of having as much and as free a circulation of air as possible; and, 2dly, being at a very trifling expense in glass. I may even add a third, which is that of excluding the sun, when it strikes into the room, by closing the shutters, which thus act as blinds, without any extra expense. Such windows I should recommend to all Australians, rich or poor: the glass part may be secured inside by a small shutter of its own.

20



Another important thing would be, to have a good-sized room, open on three sides, without walls, but with very far projecting eaves; by which great breadth of shade would be secured all round the house. This might be used for the general sitting-room of the family in summer: it would be cooler

than the open air, and could be roofed with thatch of maize or long grass; or, if time be allowed, vines or broad-leaved creepers would soon form a natural covering. These open rooms are very frequent in Sicily, and are the most delightful drawingrooms in a warm climate that can be imagined. One of the sitting-rooms should have a small fire-place (slate stove), in case of a few cold nights in winter; for, so much is the constitution affected by a change of climate, that I have often shivered with cold in the tropics, and ordered a fire when the thermometer was at 68°. Economy, in a country where labour is so dear, must be the first consideration with the majority. I should therefore recommend all the rooms to be on the ground floor, but the walls to be so contrived as to be capable, in some instances, if necessary, of being raised hereafter; or the ceiling made sufficiently firm to admit of a loft between that and the roof. I have a great predilection for mud walls, knowing, from experience, how remarkably cool they are in summer. The material is always on the spot; the erection is cheap; and, if the cottage is coloured, and built in good style, it will always be a pretty, if not a beautiful, object. Lastly, overhung roofs, or projecting additions thereto, are great promoters of shade; and, to conclude, no style is more appropriate for warm countries than the lightest Italian. I trust these hints may cause some of our professional gentlemen to found a new style of building, by which thousands of our countrymen may be benefited, if they will communicate their designs to your Magazine. — *W. Swainson. Tittenhanger Green, Dec. 20.* [It is not our intention to publish a second edition of the *Encyclopædia of Architecture* for many years to come, because that would be unjust towards the purchasers of the first edition; but we have a supplement in preparation, which will be published in the course of this or next year, and in which we shall attend to our correspondent's suggestions; who, in the mean time, has our best thanks for his communication. — *Cond.*]

---

### ART. III. Queries and Answers.

*DR. ARNOTT'S Stove, as applied to the heating of Plant-houses.* — Should this meet the eye of any of your readers who have had under their management houses heated by Dr. Arnott's stove, or otherwise had an opportunity of ascertaining whether it has ever been successfully employed in heating conservatories or green-houses, they would greatly oblige by communicating the same, through the medium of your pages, to — *W. H. Baxter. Botanic Garden, Oxford.*

*Different Species and Varieties of Corræas.* — Your correspondent, An Amateur, in enumerating the different species and varieties of corræas (p. 42.), overlooked Mr. Milner's different crossbred seedlings, with the exception of his original variety (which is to commemorate his name), *C. Milnerii*. *C. rôsea* has already been advertised for sale, and *C. cordata* is noticed in several periodicals; besides which, Mr. Milner is said to possess many other seedling corræas, of his own raising. Nearly two years since, I registered the circumstances under which I obtained a batch of hybrid corræas, between *C. speciosa* and *C. pulchella*, and the converse. All these varieties springing from the same common parents, would lead the common observer to expect them to be all of one constitution and habits, and of the same general interest as objects of floral beauty. Yet such is not the case; and well might my esteemed friend, Mr. Marnock, speaking of *C. cordata*, remark that we were yet but novices in the art of hybridising. *C. cordata* comes into flower at the height of 10 in.; and an excellent judge in such matters (Mr. Glenny) ventured a prediction that "it would require good growing to exceed 18 in. in height;" while, at the same time, some of my seedlings show no disposition to flower at the latter height, and they promise to exceed, in stature, any of their parents. All my seedlings, like those of Mr. Milner, have a decided improvement in their foliage. This difference in seedlings produced from the

same parent, leads to an interesting physiological question, a satisfactory answer to which would be of real utility to the cause of hybridising in general. Under this impression, I should very much wish that Mr. Milner would make known, through any convenient channel, the circumstances under which his seedlings were originated; what age was the female parent at the time of impregnation; what state of health, whether in very luxuriant, moderate, or stunted state of growth; and, more particularly, at what season of the year the seeds were ripe, and whether the seeds were produced on the lateral shoots, or on strong leading shoots? You may say these are very simple questions: be it so. We all know that artificial or natural peculiarities can be, and are, transmitted from parent to offspring, in the vegetable as well as in the animal kingdom, although we cannot yet, and, perhaps, may never be able to, account why such constitutional peculiarities are so transferred. Let us, then, be content with knowing that these peculiarities do exist; let us, likewise, multiply and register as many facts as bear directly or indirectly on the subject; and, from an accumulated store of this nature, something tangible may yet be deduced for future guidance. To know when the stigma is ready for dusting with pollen, to extract unripe anthers from an intended female parent, is so simple that it might be taught to a child in a few minutes: not so the means by which certain properties may be produced, and ultimately will probably be produced at pleasure, by cross fertilisation: say, cross offspring with very dwarf and fruitful habits, or the reverse; very luxuriant habit with double flowers, or the contrary; and many other peculiarities, needless to mention here. Yet we have presumptive evidence already that all these states of existence are guided by certain fixed laws, and, perhaps, depend on the different states of development of the vital principle in the parents. Any facts, therefore, tending to elucidate such laws or states of development, cannot be but interesting to the physiologist, and of the greatest use to the hybridist. The following statement, although slightly touched on in a former article of mine, will have its use at this season, when my readers are preparing to try their skill in producing crosses in the *corræa* and other families. *C. speciosa* or *C. pulchella* may be both used for female parents: either of them may be tried with *virens*; but clear clean colours in the flowers of this cross cannot be expected, the thing being as much a matter of curiosity to ascertain the powers of crossing in this very interesting genus, which, like the fuchsia, is a favourite with every one. *Virens* and *rufa* will no doubt cross; but, in this case, *virens* alone ought to be used as the female parent, *rufa* being so insignificant a flower, it would be likely soon to reduce the flowers of *virens* in the offspring. From this cross, by breeding in and in, as the farmers say, a clear white-flowering offspring may reasonably be expected in the third generation; while, by crossing in and in the highest-coloured varieties from *speciosa* and *pulchella*, we may expect deep crimson flowers. This will be the time to try, by crossing the pure white seedling from *virens* and *rufa* with this deep crimson variety, to procure clear intermediate colours. All the species and varieties ought to be tried with *alba*, but the result is very doubtful: however, to use a fireside phrase, there can be no harm in trying it; and, though if the *alba* is found to cross with any of the above, we may presume on the offspring being sterile, yet if we could but obtain the least particle of pollen in this offspring, we could easily work our way into the hardy constitution of *alba*, which would be a very desirable result.

As to the manner of conducting these experiments, a few words may not be out of place to amateurs and young beginners. Take the healthiest plants you can procure; and, unless you have very healthy vigorous plants, go directly to the nursery, and procure a few of each sort, with plenty of blossom buds on the strongest leading shoots. Mind, this is the grand secret of the whole business. A practical gardener may take these from the green-house, or even cold-frame, into 75 degrees of heat at once; but those not conversant with the treatment of plants would soon kill any plant by such a sudden transition. From the middle of February to the end of March is the best

time to take the plants into the stove. Pinch off all the leading buds on the lateral shoots, but not on the leading shoots. As soon as the flower expands, extract the anthers from the intended female parent; and next day, or as soon as you perceive the pistils getting moist, apply the pollen; at the same time making two or three slits in the whole length of the corolla, to let out the sweet secretion often lodging on the germen. See that the decaying corolla does not damp off the style, which ought to be preserved till it dries of itself. As soon as you perceive the germen swelling, stop the leading shoots. Apply all safe stimulants till the seeds are ripe, but do not let the plant expend its energies in the production of young wood. Pinch off every bud as it offers to expand. Keep the plant or plants as near the glass as possible all the time, and sow the seeds as soon as ripe. Seedlings produced in the green-house will not be near so vigorous as those in the stove; and their being originated in heat does not alter their hardiness in the least.—*D. Beaton. Kingsbury, Jan. 16. 1839.*

*The Manchester gigantic White Celery, and the large new Purple Russian Celery.* (Vol. XIV. p.639).—The former may be procured at most of the large seed shops; but of the latter I know nothing. I believe, however, that I can inform your correspondent of a sort of celery superior to the Manchester, both in point of size and flavour. It is a variety raised by Mr. Seymour, gardener, Carlton Hall, near Snaith, Yorkshire, about the year 1830. It has been grown by him to 6 lb. weight each head; and a few plants received by Mr. James Kingston, gardener to Philip Saltmarsh, Esq., of Saltmarsh Hall, near Howden, Yorkshire, from Mr. Seymour, weighed 13 lb. a head after the soil and decayed leaves had been taken off, and was 5 ft. high. Their stalks were exhibited at the Doncaster Horticultural Show, where they were much admired. I have seen this celery grown very large in the gardens of the Countess of Bridgewater, at Ashridge, by Mr. James Seymour, the gardener there. It has been grown by the side of, and has received the same treatment as, Bailey's gigantic Manchester, and other sorts, but was superior to them in weight, solidity, and flavour. Mr. James Seymour has informed me of the weight of some roots dug up at Ashridge this season. One, on Nov. 4., weighed 2 lb., and was 1 ft. 6 in. in height, and 10 in. in circumference, ready for the table; one, Nov. 15., which weighed 5 lb., was 3 ft. 2 in. high, and 13 in. in circumference. One of Seymour's superb white celery, which weighed 4 lb., was 3 ft. 2 in. in height, and 11 in. in circumference. These last were weighed after the soil and outside leaves had been taken off.

Having grown this celery myself, I can speak with certainty as to its being superior to any other sort I have seen. I believe the seed of the red celery is to be procured of Messrs. Brown, nurserymen, Slough, and at the Egyptian Hall, Piccadilly, London: the white is not to be had.—*Henry C. Ogle, Dec. 29. 1838.*

---

#### ART. IV. Obituary.

DIED, Dec. 22., *Mr. George Penny, A.L.S.*, late partner with Mr. William Young of the Milford Nursery. Mr. Penny was well known as one of the best practical botanists and propagators in the neighbourhood of London. He particularly excelled in a knowledge of herbaceous plants, as his articles in the earlier volumes of this Magazine, and the *Catalogue of Herbaceous Plants in the Epsom Nursery*, which was prepared by him, abundantly prove. He had been slightly indisposed for three or four months previous to his death, and at last dropsical symptoms appeared. His sufferings during the last two days were very great; but death at length released him.—*Henry Allen. Milford Nursery, Jan. 2. 1839.*

---

THE  
GARDENER'S MAGAZINE,  
MARCH, 1839.

---

ORIGINAL COMMUNICATIONS.

ART. I. *Notes taken from the Narrative of a Horticultural Journey in Greece, during the Summer of 1837.* By EUGENE ACHILLE BAUMANN, of the Bollwyller Nursery.

I KNOW not whether a short account of the present state of horticulture and agriculture in Greece might not interest some of your readers. It is true that this country is daily visited by travellers, your countrymen in particular, who, in their narratives, infinitely more interesting than mine, introduce everything worthy of notice; but this celebrated country presents so many curiosities of all sorts, that horticulture, the subject which particularly interests me, and which is at the very lowest ebb, could never have particularly attracted the attention of any one having a different mission from mine.

After having visited almost every part of Italy, where I found many things to interest me, I arrived at Trieste in the spring of 1838, regretting much to be obliged to leave that fine country. At Trieste, however, I received the necessary instructions from my friends for undertaking a still longer journey. I was to proceed to Athens in Greece. The object of my journey was to open some commercial negotiations with the amateurs of the country, as well as with those persons at the head of the government who might be favourable to an enterprise of this sort. A new country, or, rather, one rising out of total ruin, like Greece, presents many fair chances: for, the want of vegetables and fruits, as well as of forest trees, is very soon felt in a country so situated. What particularly induced my family to this step was, that for several years past we had been sending ornamental and fruit trees to a considerable amount to the Greek government, as well as for the plantations of King Otho.

I embarked about the middle of May, 1837. Finding a favourable opportunity for extending my journey to Smyrna and Constantinople, I went direct to Smyrna\*; thence I went by land to Brussa and Scutari, and arrived in Greece, after a stay

\* I proceeded to Smyrna, touching at Ancona, Corfu, Patras, and Athens, and reached Smyrna by Syra and Scio.

of some weeks in Constantinople, and a quarantine of twenty-four days in the Isle of Syra.

I arrived in Greece about the end of July. What a difference between the coasts of Attica or of the Peloponnesus and those which I had just passed! The shores of Asia Minor, of the Bosphorus, and of the Dardanelles are filled with gardens, which present to the eye of the traveller a vigorous vegetation, as varied as the nations which inhabit them. Those of modern Greece were naked under the burning July sun; the little vegetation which had flourished there had been completely withered up; and before I perceived some signs of habitation, I thought I was landing on a rock abandoned at once by man and nature. I saw nothing above the surface but some remains of the gigantic monuments of the ancient Greeks.

I landed at the Piræus, and proceeded, soon after landing, to Athens. The road which led to the city was new; on the right and left were planted, at a considerable distance from each other, plane trees, poplars, alders, and some walnut trees. It was rather difficult to distinguish these trees at first, as they were generally in bad condition, and the greater part of their imperfect heads was without foliage.

The road also passes through a forest of olive trees; it is the only thing in the neighbourhood of Athens, useful to the inhabitants, that has not been entirely destroyed by the stolid ferocity of the Turks and Egyptians. This forest made no better impression on my imagination than the first aspect of the country. Those who have seen forests of olive trees know that their livid hue entirely changes the character of the landscape.

I arrived at Athens; and the first thing that struck my sight, that delighted me, was, not so much the imposing aspect of the Acropolis, and of the Temple of Theseus, as the finding of a date tree, nearly 50 ft. high, growing in the middle of the Via d'Hermes. This date tree had continued to grow, and had not been injured by any one; besides this specimen, I saw five or six others in the different districts of the city, also several cypresses, but these were all.

It must be confessed that Athens, for a celebrated city, presents but a denuded aspect; this cannot be said, however, of some places, situated at a little distance from the city, such as the village of Marupi, that of Kephyssia, Angello-Kibi, &c. In these places we meet with a tolerably vigorous vegetation. At Kephyssia several foreign ambassadors have country houses; the Russian ambassador particularly has a large establishment; and there is there a magnificent group of plane trees (*Plátanus orientális*), planted, no doubt, by some Turk. There are also a considerable number of mulberry trees, some fruit trees, pear, apple, and plum trees. Close by is a very old plantation of olive trees;



and in the neighbourhood flows a small rivulet, the banks of which are adorned by a very vigorous vegetation of *Laúrus nóbilis*, *Mýrtus commúnis*, *Vítex A'gnus cástus*, *Ceratónia Síliqua*, *Mèlia Ázéderach*, several rhamnuses, &c. These trees, both large and small, are every where alternately intertwined with vines and *Vítex A'gnus cástus*; and, where the moisture does not reach, an immense number of myrtles grow. *Pistàcia Lentíscus* also grows there profusely; in short, one is agreeably surprised at the great variety of brilliant foliage which abounds there. The *Nèrium Oleánder* is particularly beautiful; it towers above the other shrubs which surround it, and presents a flourishing bouquet throughout the year.

These villages were formerly places of rural retreat for the Turks, as they are now for the Greeks. I found every where the remains of Turkish houses; which have been quite destroyed, except the fountains, which are always shaded by some fine planes, or horsechestnut trees (*Æ'sculus Hippocástanum*). I have never seen these trees so well grown, or so perfect, as in the neighbourhood of these fountains; it appears as if Nature herself chose to protect and shade those fountains which the Turks erect wherever they can find a spring; and near each is inscribed a passage from the *Koran*, which invites the toil-worn traveller to come and quench his thirst.

This is all that can recall an idea of what horticulture was in Attica, before the war against the Turks; and while it continued nothing could be done. During my stay, however, I had an opportunity of seeing that, under Bavarian influence, the Greek government will bring the horticulture of this country to a high degree of perfection. Before the death of Capo d'Istrias, a nursery had been formed near Nauplia, which was then the capital; but this nursery is now neglected. I saw the greater part of the fruit trees which were sent to it from our nurseries at Bollwyller, either dying or already dead, although but recently neglected. At Athens, a new nursery had been made, and, while the greatest care was bestowed on it, the former was abandoned to neglect, and finally given up.

The Athenian nursery is under the direction of Dr. Fraas of Würzburg, a young man who devotes himself with ardour to the labours and cares which his charge naturally brings along with it. The place which it occupies was formerly the garden of a Turkish proprietor, but the king bought one part of it, and the government the other.

Hitherto only such trees and shrubs as were most wanted in the country have been planted in the government part of this garden. In the part belonging to the king, such culinary vegetables are cultivated as the country does not produce naturally; such as cabbages, asparagus, salads, peas, kidneybeans, &c.

A great number of fruit trees have also been planted, which grow well; some plum and pear trees were there previously, as well as some vine stocks, and mulberry and pomegranate trees. Fig trees were plentiful.

Of ornamental plants, Dr. Fraas had planted a certain number of dahlias, which I brought from Trieste and left at Athens, on my first journey there. On my return, after a very short period of time (two months), I found all these plants grown and in beautiful bloom; besides this, I saw a fine collection of annual plants, which grow there with unexampled rapidity and vigour.

We may rationally conclude that the country has not always been so bare of vegetation as it is at present: the soil is very fruitful and good in the plains; though less so on the elevations of the mountains, which are generally calcareous. The best proof of the fertility of the soil is, that Dr. Fraas having had a number of mulberry trees transplanted, the stems of which were generally more than a foot in diameter, they all, without a single exception, continued to grow. The year after their transplantation the heads were a little cut, and in a few months afterwards, they formed new ones, which exceeded the old ones in strength, size, and thickness.

The Athenian nursery is situated in the forest of olive trees mentioned at the beginning of this paper, at about half a league from Athens, on the road which leads from that city to Eleusis.

On the other side of the road, the military commander has had the soil prepared, where the olives are planted regularly, and cultivated for the advantage of the Bavarian garrison; peas, kidneybeans, cabbages, turnips, &c., are raised here very successfully. This place, as well as the king's garden, can be easily watered by a conduit, which proceeds from the city. Watering is very necessary, and it is not surprising to see an almost total want of vegetation in so warm a climate; at Athens particularly, since this rivulet, if I may so call it, is the only one which supplies water during the whole year. We read in ancient history, and see in many modern maps, several rivers marked near Athens. In the time of Alexander the Great, as we are told in history, a small part of his cavalry was sufficient to exhaust the water of the Cephissus; at present its bed is very perceptible, but I never saw a drop of water in it. In the neighbourhood of the city several other dried up beds of rivers are also pointed out.

The resident plenipotentiary of Austria, M. le Chevalier Prokesh von Osten, has also formed a garden in the English style. He planted chestnut trees, *Catálpa syringæfolia*, acacias of different sorts, some of which have grown, but many have perished. Prince Pückler Muskau, who arranged the plan of this garden, advised him to plant at first *en masse*, all the trees

that would grow rapidly during the rainy season, to procure, at least, some shelter for trees of a better quality. He did so, and, as far as I could observe, he will derive advantage from it. The poplar grows with astonishing rapidity, notwithstanding the great drought. *Pinus Pinea* and *P. marítima*, which grow everywhere on these shores, would also be ornaments to these gardens, as their forms are agreeable; and the other species of *Coníferæ*, cultivated in our plantations, do not thrive so well here as these two species.

An Italian landed proprietor has also formed a garden in the neighbourhood of Athens. I observed with pleasure the rapid growth of a great number of fruit trees, chiefly apple and pear trees, which he had planted; many of them were loaded with fruit. It is also worthy of remark, that date stones, sown in the open air, have come up and grown admirably, in this gentleman's garden, as well as in the king's garden.

Before my departure, M. Lang of Darmstadt, a very able architect, was commissioned to make a plan of a private garden, which was to be formed near the new royal palace, the building of which was proceeding rapidly. A public garden, in the English taste, was to be joined to the former, to surround it, and be a place of resort for the population of Athens.

The new palace will be magnificent and very large. The beautiful marble of Pentelicus is almost the only material used in its construction.

M. Lang decided immediately on the Italian style for the king's private flower-garden, marking on the plan the place for a good number of palm trees, and groups of orange, lemon, and oleander trees. The whole to be divided into compartments by low walls, ornamented with statues, vases, &c., of marble, which they expected to find in the ruins of the ancient monuments. I have no doubt that, when the whole is finished, I shall be put in possession of the plans and elevations, and I shall then have much pleasure in transmitting them to you.

I think Greece is a country in which a garden well planted and executed would have a magical effect. All sorts of trees might be used in the arrangement. I even think a great number of South American trees would thrive. What could we not effect by uniting the passifloras, kennedyas, and the superb and light acacias of New Holland, with groups of oleander, myrtle, and *Laurus nóbilis*, crowned by magnificent date trees, evergreen oaks, *Acácia Julibríssin*, *Cuprèssus pyramidàlis* and *horizontàlis*, and orange and lemon trees! All these would thrive; and the Greeks would be happy in being able to enjoy their gardens all the year round, while we are obliged to witness five or six changes annually, every one more disagreeable than the other.

Add to this the magnificent and imposing views of the sea, of

the Gulf of Salamis, of the ruins of the Acropolis, of the Triumphal Arch of Adrian, of the ruins of the Temple of Jupiter Olympus, &c., and we may easily conceive the beauty that might be given to an Athenian garden.

I shall not forget to communicate to you, at the same time, some particulars as to the customs of the Greeks themselves, with respect to the subject that interests us.

Their culinary vegetables consist generally of young pumpkins, not fully grown, *Cucúrbita Lagenària?*, with other species and varieties; the fruit and seeds of *Hibíscus esculéntus* are used exactly as peas and kidneybeans are here. Their taste is rather sour and very refreshing; tomatoes (*Solànum Lycopérsicum*) are used all over the country in almost every dish. *Cicer arietinum* is eaten by the common people, who generally carry some of these plants in their hands, eating the seeds without any preparation. *Cucúrbita Citrillus*, the water melon, is brought in immense quantities from the islands of the Archipelago. The people eat them greedily; they are very good and refreshing, but somewhat dangerous. Several other kinds of melons are also brought from the islands, some of them of an exquisite flavour. The flail is not used for threshing out the corn in Greece. In every village there are round paved places, where the inhabitants spread out their corn, and have it trodden out by horses. On the arrival of the Bavarians in this country, an officer ordered several flails to be made, with the intention of teaching the Greeks their use; and some soldiers were set to work with them for this purpose. The Greeks, of course, approved of the new way for them; "but why should we tire ourselves," said they, "when our horses can do it as well with their feet?"

That awkwardness, or idleness, which is perceptible on many occasions, struck me particularly on seeing them digging or trenching the ground. It is extraordinary how men in this warm climate can remain bent, and sitting on the calves of their legs, or, rather, doubled on their legs, for hours together, and not upright, as every where else, working with implements which never have longer handles than from 2 ft. to 2 ft. 6 in.

The climate of Greece being so favourable for the vine, accounts for the country also abounding in wine. We must not, however, expect to see the vine cultivated regularly; the stocks are planted, they are allowed to grow, and they are thought of no more till the time of the vintage. Those wines which come from the islands are very good and light; those, on the contrary, which are made on the continent, for want of cellars and reservoirs for keeping them in, are always mixed with resin or gypsum. The taste produced by this mixture is at first extremely disagreeable, particularly when gypsum or plaster of Paris is used. I soon got accustomed to the mixture of resin, which

seems at first to be turpentine. The latter custom, in this warm climate, is a very good means of promoting digestion.

This is nearly the amount of the notes which I wrote during my stay in this country. I can, if you wish it, communicate other matters to you, perhaps still more agreeable than these.

*Soho, London, September, 1838.*

---

ART. II. *A Series of Articles on the Insects most injurious to Cultivators.*

By J. O. WESTWOOD, F.L.S., Secretary to the Entomological Society of London.

NO. 15. CELERY AND CHRYSANTHEMUM LEAF-MINERS.

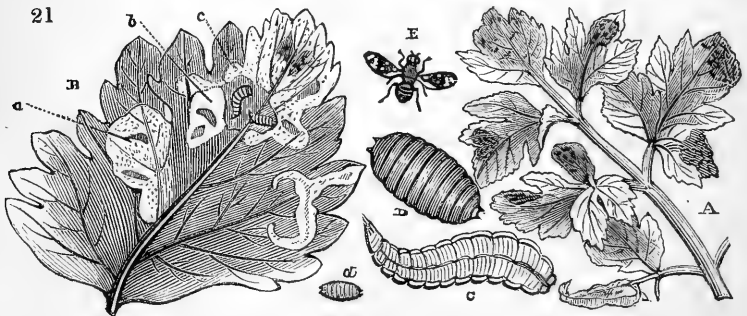
THE leaves of plants have been with great propriety termed their "lungs," since, being the principal organs of respiration, and contributing to the growth of plants by their powers of absorption, it necessarily follows, that the health and vigour of every plant depend very much on the number and amplitude of the leaves. Defoliation, either naturally or by art or accident, instantly arrests their growth, and the failure or diminished expansion of foliage is a "certain sign of debility." (*J. Main in Brit. Cyclop. Nat. Hist.* vol. i. p. 580.) In the higher animals and man, we know, by sad and numberless instances, that derangement, even be it ever so slight, in the respiratory organs, produces immediate and baneful results upon the system. And we may readily conceive, that when the entire substance of a leaf has been eaten by a caterpillar, or its parenchyma devoured by a minute larva, which has the instinct to leave the two surfaces of the leaf entire, the effect is the same; inspiration and respiration are prevented, and the plant gradually sickens, unless, indeed, it has power to throw out fresh leaves.

The mining of leaves by caterpillars must have attracted the attention of many of our readers, who may have noticed on the leaves of many plants, as the rose, sweet briar, bramble, primrose, alder, vine, &c., various slender tortuous lines gradually becoming wider, running in all directions, distinguished by their brown withered colour. These, to the incurious observer, appear to be nothing more than withered parts of the leaf, produced by some atmospheric action, which he terms blight. They are, however, the tracks of minute caterpillars which reside within the leaf, and which feed upon the parenchyma, often undergoing their transformation to pupæ within the leaf, out of which they protrude themselves previously to assuming the perfect state, by the assistance of the short spines on the dorsal segments of the abdomen, as in the case of the rose moths, described in a previous article. In other species, the larvæ, when full-fed, quit the leaf, and descend into the earth, where they become

pupæ. Many of the perfect insects produced from these leaf-miners are amongst the most brilliant of lepidopterous insects; their wings, of tiny size, being ornamented with patches of gold and silver. Besides which, they are liable to the attacks of parasites equally beautiful with themselves; so that the investigation of leaves infested with miners will amply repay the time bestowed on their examination.

But the instances of leaf-mining which are the more immediate objects of this article, are far more detrimental than those of the rose-leaf-miner and some others, which only form a slender line along the leaf; inasmuch as the entire leaf, or, at least, great patches of its surface, are consumed and withered; and, as this takes place in the autumn, it is impossible that the plants can throw out fresh leaves to make up for what they have lost.

During the autumn of 1837, my attention was directed by Mr. Lumsden, one of the assistants in the Horticultural Society's garden at Chiswick, to the state of the celery, of which the leaves had to a great extent the appearance of having been scalded with hot water. About the same time my father (who was trying some experiments in order to grow his celery of the size which it had attained in the garden of a friend, who had taken the prize for this plant for several years, at one of the provincial horticultural shows\*,) found his plants attacked in a similar manner: and, during the past autumn, the celery in the gardens to the south of London especially has suffered; Mr. Loudon having sent me specimens received from Bromley, where the insect was injuring all the celery crops in that part of the country, and had done so for two or three years past. Of course, the blighted appearance of the leaves is attributed, either

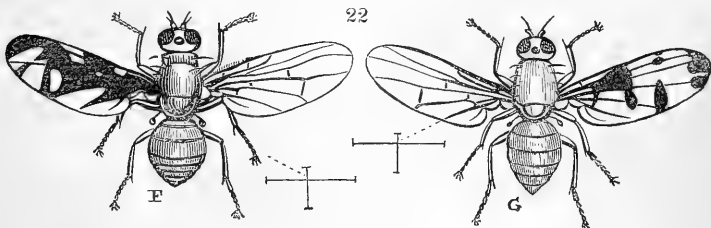


to the strong wind, or the cold spring, or the hot sun having scorched the plants, while in a wet state, from a shower in the heat of the day. I have endeavoured, in *fig. 21. A and B*, to give

\* One stick of this gentleman's celery was sufficiently large, with cold meat, to sup twelve of his friends.

the appearance of the leaves of which various parts are destroyed, by shading the shriveled part; but it is difficult, without the assistance of colour, to convey the real appearance of the leaf.

On examining the leaves, and opening part of the withered portion of the leaf (*fig. 21. B: a*, withered part of a leaf; *b*, portion of the withered part raised up, to show the state of the interior, *c*), the interior was found to be quite destitute of pulp, and to contain one or several small green grubs of a dipterous insect, which had eaten all the interior parenchyma, leaving only the two surfaces of the leaf entire, but very thin. I found as many as three, four, or even five, in a single leaf, in which case I noticed that they were occasionally of different sizes. The appearance of these larvæ under a magnifying glass (*fig. 21. c*) is very similar to that of the onion fly, and many other dipterous larvæ belonging to the herbivorous species of *Múscidæ*; but the colour is delicate green, the sides of the body very transparent and glassy, and the alimentary canal perceivable down the back by its dark colour; the head and anterior segments of the body are gradually attenuated, and terminate in a point. When these larvæ are fully grown, they quit the leaves and descend into the ground, where they gradually shortly afterwards appear to lose all vitality, their form becoming shorter and oval, with the segments distinct, and terminated at each end by two obtuse points (*fig. 21. : d*, natural size; *D*, magnified). The outer skin of the larva is not cast off, but becomes a hardened pellicle, within which the real pupa is not to be found. In this state the insect remains buried in the ground until the following spring, when the warmth gives birth to the imago, which is one of the most beautiful of our species of two-winged flies; which, after throwing off its pupa skin, and bursting through the hardened pellicle of the larva, crawls to the surface of the ground, and then takes flight. It belongs to the



Order, *Diptera* *Linnaeus*.

Tribe, *Myodariæ* *Rob. Desvoidy*. (Family, *Múscidæ* *Leach*.)

Subfamily, *Tephritides*.

Genus, *Tephritis* *Latreille*. *Trypeta* *Meigen*.

Subgenus, *Euleia* *Walker* (from the smoothness of the body).

Species, *Tephritis* (*Euleia*) *onopordinis* *Fabricius*.

Syn., *Tephritis centauræ* *Fabr. Meigen*. (*Fig. 21. E*, natural size; *Fig. 22. F*, magnified.)

The general colour of the body varies from rusty brown to shining black; the head buff, with black hairs; the legs and halteres yellow; the thorax with long black lateral hairs; the wings black, with numerous limpid spots of various forms and sizes; the scutellum often paler rusty coloured. In some specimens dark markings of the wings are varied with paler fulvous, presenting a still more beautiful appearance. The under side of the body is paler yellow. The abdomen and thorax are highly polished. It is about one sixth of an inch long, the expansion of the wings being about one third of an inch.

The motions of this fly are very peculiar, seated upon a leaf in the sunshine, their wings are carried partially extended, and at the same time partially elevated; and they have a sideling kind of motion, which they possess in common with but few other *Diptera*. I have generally found them in the perfect state basking on the broad leaves of the laurel. Fabricius and Macquart say they frequent the thistle. Fallen is silent as to their habits. From the specific names which have been given to them, it might be supposed that they were attached to the *Onopórdum* and *Centaurèa*; but such I do not apprehend to be the case, as we generally find that, if a species attached to a particular plant is compelled to resort to another plant for food, it is generally of the same natural order as its real food. I have found these flies throughout the summer, and, from what I have observed above, as to the discovery of different-sized larvæ on the same leaf, I have no doubt that, like the house-fly, there is a succession of generations throughout the year. I have, for instance, found seedling celery in pots attacked at the beginning of summer, and I presume that these individuals arrive, in a comparatively short time, at the perfect state, and that their progeny continue to increase without any regularity in the period of the broods. The extermination of the insect must be looked to from the earliest appearance of the withering of the leaves. To destroy the perfect fly seems impracticable; although, perhaps, hanging lines of string covered with bird-lime, over the rows of celery, might be attended with success. The plucking off of the infested leaves, or the crushing of the larva with the hand, without destroying the leaf, is recommended by Major, and appears very likely to be successful, if adopted in the beginning of the summer; as the destruction of one grub at that period will not only prevent the production of a numerous progeny, but will also insure the better growth of the yet tender plant.

The other species of leaf-miner, proposed to be noticed in this article, attacks the chysanthemum, and has been communicated to me by my friend Mr. Ingpen, the description of whose admirably kept garden has formed the subject of one of



your late articles. This gentleman forwarded to me leaves of chrysanthemums during the past summer, of which patches were dried up, precisely similar to those of the celery leaves; the larva which produced the mischief was similar to that of the *Tephritis onopórdinis*, and it underwent its changes in a similar manner, so as to render a detailed description unnecessary. Whilst feeding, I observed, through the transparent surface of the leaf, that it used the two bent hooks or mandibles, which it has the power to retract within or protrude from the mouth, like a pair of scrapers, or rather like the instrument known to entomologists under the name of the digger. By this action the parenchyma was entirely destroyed, and brought into a state to pass into the mouth of the larva without difficulty.

The perfect insect appeared in the month of August. It is about the same size as the preceding, and prettily marked, but is not so elegant a fly as the other. It belongs to the

Genus, *Tephritis*.

Subgenus, *Acidia?* *Rob. Desvoidy and Walker.*

Species, *Tephritis (Acidia?) artemisiæ Fabr. (Fig. 22. G, magnified.)*

Presumed varieties: *Trypeta artemisiæ, alternata, continua, intermissa, and abrótani, Meigen. (Walker in Entomological Magazine, No. xi. p. 84.)*

It is of a pale yellowish buff colour, with a few black hairs, especially at the sides of the thorax; the wings are limpid, but slightly tinged with yellowish, having several black spots of various shape and size, forming three uninterrupted bands across the wings.

The modes suggested for the destruction of the preceding species are equally applicable to the present.

In the magnified figures, one wing is represented unspotted, in order to show the disposition of the veins.

---

### ART. III. *On the Employment of Arnott's Stove for heating Green-houses.* By T. RIVERS, Jun.

HAVING recently built a new green-house, and feeling unwilling to incur the expense of fixing a hot-water apparatus, yet anxious to spare the great expenditure of fuel, occasioned by brisk flues, my attention was turned to Arnott's stoves as a medium. Accordingly, early in last December, I procured from Cottam and Hallen, one of their 18 in. stoves, which is now, and has been since then, in constant operation. My new house is 60 ft. long, by 12 ft. wide, with a span roof; the stove is placed at one end, within a few feet of the door. To explain why I had it placed at the end, rather than in the centre, let me here say that, feeling rather sceptical as to its efficacy in engendering sufficient

heat, I had built at the other extremity of the house a common brick flue, 20 ft. in length, in case of exigency. I will now give the result of my observations.

During the frost of the 8th and 9th instant, with the assistance of one hour's heating of the flue in the evening with brushwood, the thermometer was kept up to  $50^{\circ}$ , and, of course, the frost completely excluded. Still, wishing to ascertain with greater exactitude the capabilities of Arnott's stove, I have had, during the sharp wind frost of to-day, nearly 30 ft. of the house next the stove partitioned off by mats, so as to give me a small green-house, 30 ft. long, 12 ft. wide, and 10 ft. high. In this house, then, has the stove given all day, with a moderate fire, and the consumption of not quite a peck of coke, from  $50^{\circ}$  to  $60^{\circ}$  of heat. To take off the arid and rather harsh nature of this heat, I have had a zinc pan of water, 2 in. deep and 18 in. square, placed on the stove; the evaporation of which gives all the softness and moisture that can be wished for.

It must be borne in mind, that, in this trial, 9 ft. of the glass roof out of 15 ft. has been covered with double mats, as is usual in severe frosts with all green-houses. At this moment, 8 P. M., the thermometer, in the open air, is at  $28^{\circ}$ . In the house of the before-mentioned dimensions, heated by Arnott's 18-inch stove, it is at  $60^{\circ}$ .

I hope I have now said enough to convince plant-growers, that for small green-houses, or even for moderate-sized ones, this stove will effectually keep out frost, which, of course, with green-houses, is all that is required. For plant amateurs, more particularly those who do not keep a regular gardener, it is invaluable; for the little attendance required can be given by a maidservant. No overheating can take place, and no danger to buildings is incurred; and, if the simple prevention is taken, of sprinkling the inside of the stove, when it is cold, with water, to lay the dust, preparatory to cleaning it out, not the least particle of dust escapes. This is a great advantage, as all other stoves give so much dust, as totally to unfit them for the inside of plant-houses. To nurserymen and dealers in green-house plants, this stove is indeed a boon, for what numbers of lovers of green-house plants have been deterred from undertaking their cultivation, owing to the daily and nightly care required during frost, to keep brick flues regularly heated; and sometimes, owing to the great expense of fuel, and the calculation that the frost would not be severe, a fire has not been lighted some nights at the end of winter, and then all the previous care has been destroyed by the admission of frost to the plants. Now, with Arnott's stoves, any pit or large frame may be made frost-proof; and, as the consumption of fuel is so trifling, a fire may be lighted every night, and the expense not felt. Some caution

is required in purchasing these stoves. I bought two of an inferior construction, and found them both useless. Fortunately, Messrs. Cottam and Hallen had supplied a neighbour with one of the regular construction to heat his servant's hall, a room of large dimensions. This acted so admirably, that I immediately procured one from them; the effects of which I have thought it my duty to give you, to register in your legitimate pages.

*Sawbridgeworth, Jan. 7. 1839.*

---

ART. IV. *Description of the Picea Pinsapo, a new Species, discovered in Spain by M. E. Boissier, in 1837.* Abridged from a Communication in the "Bibliothèque Universelle de Genève," No. 26. (Février, 1838), by PETER LAWSON and SON. Communicated by CHARLES LAWSON, Esq.

IN April, 1837, M. E. Boissier had an opportunity of inspecting a collection of dried specimens from Sierra Bermeja, near Estysona, made by his friend M. Hänseler (who had devoted much attention to the indigenous botany of the district of Malaga), amongst which he discovered a branch of a Conifera, the peculiar appearance of which struck him. On farther enquiry of his friend, he was informed that the tree in question formed forests in the higher parts of Sierra Bermeja; that it was known in the country by the name of Pinsapo; that he never had found it in fruit, and that he always looked upon it as a variety of *Abies excelsa*. Being at Estysona about a fortnight afterwards, M. Boissier determined on visiting Sierra Bermeja; and, after traversing the forests of *P. maritima* which occupied the lower grounds towards the sea, he first observed the Pinsapo at an altitude of about 4,000 feet; and, after looking in vain both on the trees and on the ground for its cones, was informed by a peasant that these only began to grow in the end of spring, and that they ripened and fell to pieces in the beginning of winter. He also heard the people at Ronda talk about Pinsapo, and was told that great forests of it existed in the higher calcareous mountains of Sierra de la Nieve, between Ronda and Malaga; where the leafy branches are much used in decorating rooms on festive occasions, and also for carrying in religious processions, on account of the horizontal ramification of the branchlets resembling small crosses.

M. Boissier returned to the Sierra de la Nieve, accompanied by M. Hänseler in the end of September following, and, at the height of 3,500 feet above the level of the sea, first observed a few trees of the Pinsapo, the top of one of which was loaded with cones, the appearance and habits of which showed that the

tree belonged to the genus *Picea*, from the only other European species of which (*P. pectinàta*), its other characteristics render it essentially different. They found the *Pinsapo* abounding in all the higher parts of the mountains, particularly on the northern exposures, reaching even near to the summits, and only terminating where the snow lies at least from four to five months in the year. [Hence there is every reason to conclude that it will prove sufficiently hardy for the climate of Scotland.—*Trans.*]

M. E. Boissier resolved on naming his discovery *Abies* (*Picea Arb. Brit.*) *Pinsàpo*; and gives the following distinctive characters between it and the *P. pectinàta* or, silver fir.

The *P. Pinsàpo* forms a tree, averaging when fully grown from 60 ft. to 70 ft. in height. Its branches are regularly verticillate and very densely clothed with laterals, even to their base, those towards the ground, when standing exposed, being scarcely longer than those near the top of the tree, giving to its general appearance more of a cylindrical than a pyramidal form. The bark is darker-coloured and more scaly than that of the silver fir. The branchlets are also much more numerous, more regularly and horizontally ramified, or cruciform, as before noticed, which characteristic is, however, less marked in the fruit-bearing branches. The leaves are extremely short, not more than half as long as those of *P. pectinàta*, and placed at right angles, regularly over the surface of the branchlets, giving them a cylindrical (not pectinate) form. Farther, they are very stiff, and sharp-pointed; and they are never channeled like those of the silver fir. On the lower parts of the tree, and where least exposed, they are nearly flat, with a single central nerve on the under surface; whilst on the upper, and especially on the fruit-bearing branches, they are shorter, more bristly, and of a somewhat quadrangular form, projecting on both surfaces, particularly the under one, which is also slightly marked by two furrows, one on each side of the projecting centre, thus forming the only and a very superficial indication of the two silvery lines so strikingly marked on the under side of the leaves of the silver fir.

M. Boissier not having seen the plants when in flower, is able to say little on that subject, only the male catkins are, he believes, terminal. The ripe cones are sessile, erect, and placed in great numbers towards the extremity of the top branches (probably on the wood of the previous year?). Their shape is ovate-oblong, terminating abruptly at the top, often with a small elevated point. They are about the same length as, but thicker in proportion than, those of the *P. pectinàta*; from which they differ materially in the bracteal appendages being included within, not exerted beyond, the scales, as in that species. The general appearance of the seed is very similar; and it may be farther stated, that the embryo is furnished with 7 cotyledons.

The wood of the *P. Pinsàpo* is very resinous, and resembles in colour and structure that of the *P. pectinàta*.

M. Boissier is preparing to publish a flora of those parts of Spain to which his botanical researches have extended, which will contain about 100 species of that country new to botanists, all of which he intends to figure; and among these the *P. Pinsàpo* will be included, respecting which, however, he intends getting more minute information before publishing; and, as a specimen of the work, gives, among others, the following description of this tree.

*Abies* Pinsàpo — Foliis super ramos cylindricè dispositis, 5—3 lineas longis, subteretibus, apice integris; strobilis ovato-cylindricis; squamis bracteolaribus inclusis, carpellis multo brevioribus. (*Bibl. Univer. de Genève*, tom. xiii. p. 406.)

Leaves disposed around the branches, from three to five lines long, nearly terete, and entire at the apex; cones ovate-cylindric, with the bracts concealed by the scales, or carpels, and much shorter than these are.

N.B. The feet are marked in the preceding as in the original, and consequently are according to French measure?

We have obtained one plant, from M. Cels, Paris, of the *P. Pinsàpo*, a one year's seedling, which is, of course, too small to show any of the characteristics of this highly interesting fir, which, by the preceding description, appears to us nearly allied to the *A. cephalónica*. This, however, cannot as yet be determined.

*Edinburgh, Jan. 23. 1839.*

P.S. — Since the MS. of the preceding part of this article was sent to press, we have received the following information from M. Vilmorin: —

The Pinsapo is extremely like the *Picea pectinàta*, more especially in the cone and seeds. Must we call it a species, or a variety? You have seen that M. Boissier assigns to it several characters very distinctive. What makes me incline towards his opinion is, that, in coming up, the seed leaves are sensibly different from those of *P. pectinàta*. There are one or two more cotyledons in the Pinsapo; and they are larger, straighter, and less smooth, than in the *Sapin commun* (*P. pectinàta*). On a specimen that I received, in a very bad state, from the mountains of Bonda, only one small branch had preserved its leaves; and these present a decided difference between the Pinsapo and the common silver fir. The seeds distributed here last year, by M. Boissier, have produced several plants at the Jardin des Plantes, and at Cels's, and five or six with me. — *Vilmorin. Paris, Feb. 2. 1839.*

ART. V. *Notices of the Gardens and Nurseries in Lyons and its Neighbourhood.* From the "Annales d'Agriculture, &c., de Lyon," for 1838.

THE Agricultural and Horticultural Society of Lyons was founded in 1761, revived in 1814, and reorganised in 1837. About this time the Society appointed a committee to examine the markets of flowers, fruits, and vegetables of Lyons, and also to make a tour of the horticultural establishments in the neighbourhood of that city. Various reports of the produce brought to market were in consequence, from time to time, made to the Society, and medals of silver, others of bronze, and also "la mention honorable," awarded to the most successful cultivators. These awards are independent of those given at the periodical exhibitions of flowers and other garden produce, held several times every year in the orangery of the Botanic Garden; and they are also independent of medals given for having gardens in a good state of cultivation, &c. In the beginning of September, 1838, the committee commenced making the tour of the gardens and nurseries: it occupied them three days, and the Report which they made to the Society fills 21 pages of their *Annales*. We have extracted from it such parts as we think will be of interest to the British gardener; mentioning such plants as it might be worth the while of any one having a correspondent at Lyons to endeavour to procure. Exclusively, however, of these plants, all who take an interest in the spread and improvement of gardening will have pleasure in remarking the extraordinary increase of nurserymen and florists which has taken place at Lyons since the peace of 1815, when, we believe, there was only one nursery, that of M. Sédy, and no market-gardener at all. There are now 16 nurseries and florists' gardens, and a market-gardener, who sends mushrooms to market every day in the year, and sells melons to the amount of 7000 fr. in a season. To an amateur of leisure, we would suggest, as an agreeable and useful way of passing two months, to go to Lyons, examine all the gardens which are mentioned in this article, and order such novelties as he is not possessed of, or as he thinks will be acceptable to the gardening world in England.

*Nursery of M. Bourcier, Proprietor at Francheville.* The collection of fruit trees is extensive, and that of mulberries still more so. The Griotte de Monmorlot cherry was considered by the committee as a new and fine fruit.

*The Nursery of M. Bouchard* is of great extent, and contains numerous plant-houses.

*The Garden of M. Gariot* contains a collection of rare and curious varieties of grapes. Among these are le Chasselas rose

de Fontainebleau, le Bourdelas noir, and le Charge Mulet, remarkable for the large size of their berries. Besides the above, and a number of other kinds of table grapes, there is a collection for wine-making, including le Tokai. This property, which overlooks the fine valley of Francheville, has been improved from a surface of flints to a soil so rich as to grow the giant maize to the height of three metres. (A metre is about  $39\frac{1}{4}$  in.)

*Chapelle's Agricultural and Horticultural Establishment*, under the direction of Gaillard, nurseryman, contains an extensive collection of fruit and forest trees and mulberries. Of the latter, one square contains 50,000 plants, and the total number of mulberries (*M. álba*) is between 400,000 and 500,000. Extensive plant-houses are being erected for the culture of exotics.

*The Nursery of M. Martin-Burdin* occupied the committee a whole day examining its green-houses, stoves, pits, hot-beds, orangery, and open ground. A large collection of dahlias was now in flower, and the fruit trees were in excellent condition, except the peach, which, owing to the late spring, has not succeeded well anywhere. There is here a large collection of florist's flowers of every kind, such as tulips, hyacinths, chrysanthemums, pæonies, &c. In the stove, *Carmichaëlia austrális* was in fruit, and *Arracàcha esculénta Hook.* was alive, but they had not ventured to place it in the open air. In the orangery was a *Nèrium atropurpùreum*, esteemed rare; and, in the open ground, a hardy variety of olive, from the Crimea [of which a plant in the Horticultural Society's garden passed the winter of 1837-8 without injury].

*Nérard ainé's Nursery and Flower-Garden, at Vaise*, contains many ornamental trees and shrubs, besides the usual florist's flowers and border plants, numerous species and varieties of pelargoniums, 20 phloxes, 30 calceolarias, *Lilium longiflòrum*, 25 species and varieties of *Magnòlia*, 8 of myrtle, 15 of *Nèrium*, 23 of *Camèllia*, 15 of *Rhododéndron*, 22 gooseberries, 25 honeysuckles, a great many fuchsias, oranges, roses, &c. Among the latter are *Madame Lacène*, a rose somewhat resembling that called the *Roi de Rome*; *le Thé Hamon*, a fine rose; *Madame Nérard*, a remarkably large and fine rose, with an agreeable smell; and *Madame Hamon*, remarkable for its flowers, and also for the acute toothings of the leaves. A pyramidal oak, about twenty years of age, bears acorns yearly; but the plants which are raised from them do not always produce pyramidal heads, many of them having spreading branches. [This is as we expected it would be. See *Arb. Brit.*, p. 731.] Among the elms are *Ulmus pyramidàlis críspsa*, *U. maculàta flàva*, and *U. macrophýlla*; the latter having very large leaves. *Zízyphus satíva*, covered with fruit; *Acer oblóngum*, which stands through the winter in the

open air; a fine variety of *Verbena triphylla* [*Aloysia citriodora*], with large leaves, and the smell of mint, discovered by M. Pascal Ortolez; a willow-leaved poplar, received from Metz; a *Syringa* resembling *Philadelphus inodorus*, but with a fragrance like that of *P. communis*; many seedling *Calycanthi*, which have not yet flowered; a new *Phillirea*, with curled leaves, obtained from seed of the common species; a rosemary-leaved myrtle, from seed of the common species; many varieties of *Ceanothus africanus*, raised from seed, and quite hardy; *Negundo alternifolia*; and a seedling *Robinia Pseud-Acacia*, with weeping branches. A tulip tree, with flexuose branches, and leaves slightly twisted (contourné): M. Nérard has frequently raised this variety of tulip tree from American seeds. Several varieties of *Erythrina*, raised from seed, and which varieties are afterwards propagated by cuttings of the root; several varieties of *Myrtus Pimenta*, one with large yellow fruit; the Japan quince, bearing fruit in the open air; about fifty varieties of vine, among which is the Bourdelas noir before mentioned, and which, on account of the largeness of its berries, is called in some places Raisin-prune; and the true Corinth, without seeds. Among the apricots, there are many Abricotiers du Pape. *Prunus dasycarpa*, not grafted. Le Cerisier de Sibérie, which, grafted standard high, forms a globular head, and does not ripen its fruit till the end of September: the fruit is of the griotte (morello) kind, large and good. Numerous sorts of pears, including the Beurré vert and the B. Lyonnais, both raised from seed by M. Nérard; the first ripens in the beginning of August, and the last in the end of December. M. Nérard is a great raiser of fruit trees, and of every description of cultivated plant, from seed; and every year he has the pleasure of finding some new varieties in his seed-beds.

The Grounds of Madame Evesque occupy a magnificent position, and have been as much improved by art as they are favoured by nature. There is a grey poplar, of a very large size, a tulip tree, and a cedar of Lebanon; and the Carolina poplar, with the mistletoe growing on it. Elsewhere, by the road side, the committee had seen the mistletoe on the maple, the robinia, the lime, and the horsechestnut.

M. Armand's Nursery is new, but contains some rare plants; such as *Solanum atrosanguineum* (*Brugmansia sanguinea*) and the Pomme Cassel, or Reinette de Cassel, an apple found in the neighbourhood, which ripens late, and keeps a very long time.

M. G. Luezel's Nursery, at Ecully, is remarkable for the very superior manner in which the fruit trees are pruned and trained. The standards and dwarfs are of handsome shapes, vigorous, and covered with fruit. The peaches and pears trained *en espalier* are particularly handsome. Several varieties of fruits



are enumerated. Wilmot's superb strawberry produces fruit 4 in. (108 millimetres) in circumference; care being taken to cut off the runners as they appear. A melon this year weighed 21 lbs. New Zealand spinach thrives, and is much liked; the summer being too hot for the common spinach. Among the ornamental trees are: *Cytisus alpinus*, with white flowers; le *Cytise parasol*, or Gros bois; and le *Poirier glutineux*, of which the pretty little fruit "would form a proper accompaniment" to that of the berry-bearing crab. Dahlias are here propagated by the bud, or rather, we should say, by the joint, or knot. After a stem has attained the height of from 1 ft. to 3 ft., according to the variety, it is cut into as many pieces as there are joints. Each piece is then reduced so as to leave a very small space above and below the joint; one of the leaves is cut off, and the cutting so formed is planted, leaving one of the leaves above ground; the greater part of its petiole being buried. Shading and the usual routine being attended to, the plants root immediately, and generally flower the same year.

*The Vineyard of M. Deputs de Maconex* contains some excellent varieties of table grapes, cultivated for the sale of the fruit. The variety principally grown is the Mornain blanc, which, when ripe, has the russet tinge, which is so much admired by the amateurs of grapes. He grows, also, le *Janean de Vaucluse*, a white, very early, fine, and good grape and the *Chasselas rouge de Fontainebleau*, of excellent quality. The *Muscat of Alexandria* is grown in the warmest places. Among the grapes grown for wine are the *Gamé noir*, and la *Sérine à graine sucré*, from which the *Côte-roti* and *Hermitage* wines are made. *Panicum altissimum* is here grown as a forage plant, but hitherto without much success.

*The Nursery of M. Poizat, at Villeurbanne*, is stated to be remarkable for its order and neatness, and the committee did not observe a single weed. All the tools are regularly disposed in a shed, each in its proper place, every evening, after the workmen leave off, properly cleaned and in good condition; if they are otherwise, they are immediately cleaned and put in order. Two yew trees, clipped into the form of candelabra, decorate the entrance to the garden; in which, among many other fine plants, were found several new varieties of *Aster*, raised from the seed of *A. Nòvæ A'ngliæ*: one is called *A. ericoides*, and has blue flowers. An *Althæa frutex* has the leaves variegated with yellow. A *Ceanòthus*, which appears to be that of Africa, but which is sufficiently hardy to live through the winter in the open air, bears abundance of seed in summer. Many seedling lilacs, remarkable for their appearance. Two varieties of *Tilia*: the one procured from *T. argentea*, which has long shoots turned downwards, and thickly clothed with leaves at their extremities; the

other is from the common lime tree, with elongated heart-shaped leaves, deeply and sharply indented. A very beautiful *Clématis*, with composite leaves having two leaflets, obtained from seed of *C. integrifolia*: the flowers are of a deep violet, and sweet-scented. There is a numerous collection of *Cratægus*, without names. Twelve sorts of poplar, of which the *Pópulus græca* totally escaped the caterpillar, while many of the other kinds were killed by it, or by the grub of the cockchafer; the former attacked the leaves, and the latter the root. Here, as in M. Nérard's garden, seedlings of the pyramidal oak were found, which did not reproduce that variety. Among the fruit trees were noticed, a currant, with very large berries; a sweet chestnut, with very large and sweet fruit, which comes true from seed; and two varieties of cherry, raised by M. Poizat. A small vineyard is occupied solely by vines raised from a seedling, which sprung up accidentally in the rotten hollow trunk of an old willow; the grape is black and large, and it is called *Vigne de Perrache*, a gardener of Perrache having transplanted the seedling from the rotten tree to his garden. It makes excellent wine.

*The Garden of M. Guillot fils, Florist, at Guillotière*, contains some fine exotics, among others un *Figuier montin*, which, though generally kept in a stove, here passes the winter in an orangery.

*The Garden of M. Guillot père, Florist and Nurseryman, near Hirondelles*, is large, and contains green-houses, hot-houses, pits, and orangeries. The stove is spacious, and on a new construction, for which M. Guillot received the silver medal of the Society in 1836. In this stove there are a great many excellent plants, as there are also in the green-house; and the orangery contains oranges, pomegranates, myrtles, neriums, &c.; among the varieties of the latter, is one with flowers of an amaranthine red, striped with white. *Le Tamarix à petites fleurs* (?) is extensively propagated. Among the rare trees and shrubs are the *Maclura* and the *Syringa Josikæa*. The white mulberry is struck by cuttings under a bell-glass on heat (*le greffe touffé* of *Soulangé*), and covered with sashes, and is well rooted in six weeks or two months; which is found an advantage, as it renders grafting unnecessary. The cedar of Lebanon, various other *Abietinæ*, and the more valuable kinds of hardy ornamental trees and shrubs, are kept in pots for the convenience of sending to a distance, and in order to insure their growth when they arrive at the end of their journey.

*M. Chainé's Market-Garden, at Guillotière*, is of considerable extent, and, besides numerous crops, contains pits and other arrangements for forcing fruits and vegetables, growing mushroom-rooms, &c. Casks sunk in the ground at different distances, over the whole garden, are connected with one another by

pipes under ground, and a steam-engine raises water, which supplies these casks, as well as irrigates the surface. When the steam-engine is not employed in raising water for the garden, it puts in motion machinery for manufacturing purposes. Manure is used in this garden to the value of between 3000 and 4000 francs annually, and it is moved within the garden on light portable iron railroads, by means of small waggons pushed by men. Asparagus and artichokes are forced in the open garden, by placing the manure over them, or between the rows or beds. Melons are grown to a great extent, and an extensive range of cellars is devoted to the growth of mushrooms, which, as already mentioned, are sent to the Lyons market throughout the whole year. Mushrooms are also grown in the open air on ridges, under sheds, and in a large house, where, during summer, the interior is darkened by tomatoes trained under the roof. This forcing-house is heated from the steam-engine. The cost of this garden is about 10,000 francs yearly, but the melons alone, in 1836, produced 70,000 francs.

*M. Girard's Nursery, at Guillotière*, is celebrated for seedling plants, both of trees and culinary vegetables. As many as 30,000 cabbage plants have sometimes been sold here daily in the planting season. The variety which at present is considered the best, is called le petit Cabus Guillotin.

*The Nursery of M. Sédy, at St. Just*, contains, near the house, a *Magnolia acuminata*, the largest in the department of the Rhone. It is 12 metres (39½ ft.) in height, the branches are 8 metres (26¼ ft.) in circumference, and the trunk 1 metre (3 ft. 3 in.) in circumference. It has borne a great many seeds for many years. There is a specimen of *Cupressus sinensis Desf.*, the weeping cypress of China, grafted on the *Taxodium distichum*, which has stood the winter for four or five years. [We should like much to have a specimen of this plant.] There are several stoves and green-houses, and a good collection in both. The *Vanilla aromatica* grows vigorously on the bark of pieces of wood, and six species of *Ficus* are in a thriving state. The list of hot-house and green-house plants in this nursery is very considerable, and includes no small proportion of the more rare species in British gardens. There is an *Erica abiétina* thirty years old, and *Uvularia mexicàna* has ripened fruit. *Wistaria sinensis* has been extensively propagated. There are thirty varieties of camellia, and fifteen of the orange. There are a tulip tree with rose-coloured young shoots; a *Gleditschia macracantha Dec.* with drooping branches; twenty different sorts of *Magnolia*; *Méspilus tanacetifolia Poiret* (*Crataegus tanacetifolia* of *Arboretum Britannicum*), the fruit of which is described as eatable; a mountain ash with white berries; with a

number of other ornamental trees, far from being common in English nurseries. M. Sédy's establishment is the oldest at Lyons, and the best-arranged, especially with respect to house plants. [In 1819, we spent about a week in Lyons, and M. Sédy's nursery is the only one we recollect to have seen.]

*M. Chapuis's Nursery, at Ste. Foy*, is chiefly noticeable for its collection of fruit trees. The fruit of the Beurré Coloma was tasted by the committee, and found excellent; but they were told that the Beurré Bosc was still better. Here they observed the difference between the Mornain blanc and the Chasselas de Fontainebleau grapes; the latter has the berries wider apart on the bunch, with a much more firm flesh, almost cracking between the teeth, and juice of a sweeter and more agreeable taste. The broad-leaved elm is here propagated by cuttings. M. Chapuis is celebrated also for his culinary vegetables. He prefers cabbage seed that is two years old, to that of one year, and grows le Cœur de Bœuf and le Chou de Milan (the drum-head and the Savoy, or something near them) to a large size.

---

ART. VI. *Arbicultural Notices, collected from various Sources, intended as supplementary to, or corrective of, the Information contained in the "Arboretum et Fruticetum Britannicum."*

IT is our intention to publish, from time to time, detached Supplements to the *Arboretum Britannicum*, in the same manner as we have done, and are doing, to our other works, in order that the purchasers of the first edition may never find it necessary to purchase any other succeeding edition, unless they think proper. Thus, we have published a detached Supplement to the *Encyclopædia of Agriculture*, we have a second detached Supplement nearly ready for the *Hortus Britannicus*; and we have one also in preparation for the *Encyclopædia of Plants*. In as far as respects our Gardening and Botanical works, all, or almost all, of the information contained in these detached Supplements, is previously given in the *Gardener's Magazine*, which, indeed, may be considered as a continuous Supplement to the books already mentioned, including the last and most elaborate of all our works, the *Arboretum et Fruticetum Britannicum*. All persons, therefore, who have an opportunity of perusing the *Gardener's Magazine*, will find in it all, or almost all, the information which is contained in the Supplements, with the great advantage of obtaining it as soon as it comes to our knowledge.

In this article, which has special reference to the *Arboretum*, it is not our intention to include all the information which we receive respecting trees and shrubs, but merely such corrections, and additional scraps of information, as, if they were given under General Notices, or even under Floricultural Notices, might escape observation. We shall arrange them in the same order as the *Arboretum Britannicum*, commencing with what is historical, statistical, and general, and then taking the natural orders in the same sequence as they are given in the *Arboretum*.

GEOGRAPHICAL, HISTORICAL, AND STATISTICAL.

*Doubts as to certain Trees being Natives of Britain.*—The Yew, Box, Furze, and Elm, are admitted with difficulty by Mr. Loudon as natives. I may

observe, as a traveller, that in no part of Europe are the Yew, Furze, Holly, and Elm so abundant, or apparently so wild, as in England. Furze is found sparingly on the opposite coast; and is then nearly lost sight of till we meet with it again in the South of France (where, it is said, they have also *Ulex stricta*). It is seen but sparingly in Italy, about Florence, in the Campagna of Rome, and on the plains of Apulia. Why, then, should it be excluded from its most obvious habitat as a native, the British Isles?

The Yew is a scarce tree on the Continent; not so in England. It is frequent in the woods of Monmouthshire, and in the ancient forest of Cranbourne Chase, in Dorsetshire; where it is a frequent hedge tree in chalky soil, in those parts of that dreary country that have been reclaimed from a state of forest, viz. between Blandford and Salisbury; also in the adjoining parts of Hampshire.

The common Ash has always appeared to me much more abundant in England than on the Continent.

The common English or London Elm grows in greater perfection here than on the Continent. I should say that the habit of the London elm, as a tree, is peculiar; and I do not often recognise it on the Continent. At Morano, in Calabria, are some gigantic elms, planted near a church, that may be the English elm. The common elm of the Campagna of Rome seems to me our Cornish elm; it is not a large tree, and the leaves turn yellow at the tips in summer.

There is a magnificent avenue of Dutch Elms at Wimpole, the seat of Earl Hardwicke, planted in the time of King William III.

Are there two trees called Wych Elm, in different parts of England; one good timber, the other bad?

Box is possibly not a native. It is abundant in Savoy, and in the Apennines of Lucca. I do not remember it in Germany, nor the Holly in abundance anywhere on the Continent.

Pine wood is said to be found in our peat bogs. Some species, therefore, must have been formerly indigenous.

In travelling south and westward from Petersburg, I remarked the succession of trees as follows:—

Petersburgh: Fir, birch, aspen, lime.

Stockholm: Ditto, with addition of oak and ash.

South of Sweden: Ditto, ditto, with beech.

Denmark: Ditto, ditto, ditto, and elm.

This would not be exactly the succession in descending the Alps or Apennines, but an alpine climate and a northern one are not in all conditions alike.

The lime is said to be abundant in woods north of Derbyshire; certainly not in the southern counties.—*Wm. Fox Strangways. Abbotsbury, Dorsetshire, Dec. 30, 1838.*

*Trees and Shrubs at Bridehead House, near Dorchester.*—There are some English elms between ninety and a hundred years old, from 75 ft. to 80 ft. high; with trunks 4 ft. in diameter at 2 ft. from the ground; and with the heads from 50 ft. to 70 ft. in diameter. There are some fine sycamores: one is between 40 ft. and 50 ft. in height, with a head 60 ft. or 70 ft. in diameter, and a trunk 2 ft. in diameter; reported age upwards of 70 years. *Arbutus Uñedo* var. *ruber* is 17 ft. high; the trunk at a foot from the ground, 13 in. in diameter, and the head 25 ft. in diameter. All these, and most other common kinds of trees and shrubs grow on loamy soil, from a foot to 18 in. deep, on a chalky subsoil. The general surface is open to the powerful west wind, which comes from Bridport Bay, and which is considered to be extremely injurious to trees in this part of the country.—*James Harbison. Feb. 1836.*

*Trees and Shrubs at Capheaton, Northumberland.*—I venture to trouble you with a few notes, as a very old planter. The situation of this place is by no means a genial one, being 600 ft. above the sea, in the centre of Northumberland, and the soil chiefly clay. Most trees, however, grow well, though slowly at first, except the oak, which does not so well suit the soil and situ-

ation. I have cut down larch above 6 ft. round, 2 ft. from the ground, not 40 years old; beech of 4 ft. and 5 ft. round, about the same age; and many others of my own planting equally thriving. But I have here beech trees of about 90 years' standing, above 11 ft. round; and some silver firs, about 80 years old, that measure near 12 ft. round, and above 90 ft. high, which are in perfect health; and there are two Portugal laurels, that I planted close together, many years since, which now measure 180 ft. round, and are 24 ft. high. There is also a *Rhododéndron* of my planting, nearly 180 ft. round.

Our evergreens were not destroyed by last winter's frost. The laurels had a few young shoots destroyed, but have quite recovered, as well as the *laurus-tinus*. The two large Portugal laurels, mentioned above, had one side apparently killed, being quite brown. I did not cut or meddle with them, and when summer came, they threw out quite briskly, shoots and leaves, and the whole plants have no signs of being injured. I am inclined to believe that, after last winter, a great number of evergreens have been precipitately cut down, that would, at least, have partially recovered. The thermometer at this place was last winter only 2 or 3 nights at 10° above zero of Fahrenheit, but about 8 miles south, and 9 or 10 west, of this, it fell 3° or 4° below zero; and, I believe, even more.—*John C. Swinburne. Dec. 1. 1838.*

*Effect of Lightning on Trees.*—In the *Annales d'Hort. Soc. de Paris*, vol. xxii. p. 120. to 134., an account is given of sixteen trees which have been struck by lightning in different parts of France, at various periods, from 1813 to 1837. The effects appear to have been very different on different trees. In some, the leaves only were entirely destroyed; in others, the leaves were but slightly injured, but strips of bark appeared to be torn off; in some, the branches were broken, and no other injury done; in some, the trunks were split; and, in others, no injury was done to the top of the tree, but the roots were laid bare, and torn in pieces. In several cases, where the trees were standing near houses, or hay or corn ricks, they seem to have acted as conductors to the electric fluid, and saved the cottage, or the corn stack, or hay rick, from being struck by the lightning. This was particularly the case, where the Lombardy poplar or the silver fir had attained a great height. The author of the article, Vicomte Héricart de Thury, concludes with the following advice:—

“1. Travellers and country people, reapers, hay-makers, &c., during the time of a thunder storm, should never take shelter under detached trees; more especially under a tree which stands at a distance from any other; such trees acting as conductors.

“2. To take shelter rather under a bush, than a tree, and the lower and more spreading it is the better.

“3. Never to take shelter on that side of an object, from which the wind or the storm comes, or, indeed, in the direction of the wind or the storm. Thus, supposing the storm proceeding in the direction of east and west, then the north and south sides of a bush, or other sheltering object, are to be chosen, and not the east or west sides.

“4. In the moment of danger, the safest way is to recline at length on the ground, choosing a furrow or a ditch, if any should be at hand; but no time should be lost in searching either for a furrow or ditch, or for a bush or hedge, because the upright position, maintained during that search, is incomparably more dangerous than the horizontal one.

“5. Always to bear in mind, that the danger is great in proportion to the shortness of the time which elapses between the appearance of the lightning and the noise of the thunder.

“6. Those who cannot afford the expense of lightning conductors to their houses, farm-buildings, and ricks, should plant near them tall-growing trees, such as the pyramidal oak (*Quercus pedunculata pyramidalis*), the Lombardy poplar (*Pópulus fastigiata*), the cypress, the larch, the silver fir, the spruce fir,” &c. (*Annales d'Hort. de Paris*, vol. xxii. p. 134.)

*Planting an Arboretum.*—I am now busy planting shrubs and trees. We

shall have a fine selection; but we plant them with a view to their growth only for twelve years (as Mr. — expects he will have to move them about that time), with the exception of the genus *Cratægus*, which we began to plant last spring. No arrangement is followed, but the best situation is fixed on for the more favourite sorts to display themselves. I am obliged to plant almost on the surface of the ground. Every plant is to be grown into a specimen, and I only make the pits large enough to supply nourishment and space for the roots for three years; by that time a zone of one foot or more will be opened round the outside of the roots, and filled in with rich compost; and this will be repeated every third year, and each time our excavation will be shallower, in order to entice the roots to the surface. This I think a preferable mode to making the pits large enough for twelve years' growth at first; besides, in our case, where the trees are expected to be removed, we can prepare their roots every third year, by cutting them in a little. — *D. B. K. Nov. 23. 1838.*

## WINTERACEÆ.

*Illicium floridanum*, Arb. Brit. p. 256. fig. 32., and Hort. Lig. p. 2., is said to be so hardy as to have stood out unprotected during the winter of 1837-8, at Hylands, near Chelmsford, where, on January 21st, the thermometer fell to 3° Fahr. There are several plants, one of which is 5 ft. in height, with the branches covering a space nearly 9 ft. in diameter. They have been planted upwards of twelve years, and flower profusely every year. (*Mar-nock's Flor. Mag.*, vol. iii. p. 124.)

## MAGNOLIAÆ.

*Magnolia macrophylla*, in Godefroy's Nursery, Ville d'Avray, was between 26 ft. and 27 ft. high in June, 1837, with a head 16 ft. in diameter, and covered with between 150 and 200 flowers. It has ripened seeds, from which numerous young plants have been raised. (*Annales d'Hort. de Paris*, tom. xxi. p. 7.)

*Magnolia auriculata* is from 15 ft. to 18 ft. high, in the same nursery, and showing from 250 to 300 flower buds. (*Ibid.*)

*Magnolia pyramidata* is there from 12 ft. to 15 ft. high, producing abundance of flowers every year. (*Ibid.*)

*Liriodendron Tulipifera* is 35 ft. high, is covered with flowers every season, and, in 1835, ripened four bushels of cones. (*Ibid.*)

## BERBERACEÆ.

A paper was read at the Asiatic Society, "On the Yellow Colour of the Berberry," by Mr. E. Solly.—Mr. Solly stated that the root of the common berberry, or *Berberis vulgaris*, was used for dyeing leather yellow; and that a cheap and abundant supply of this article was desirable. He, therefore, suggested the possibility of obtaining it with advantage from India. After describing the various species of *Berberis* which grew in India, and mentioning many of their localities, he stated that, from some experiments made by him on specimens of berberry root from Ceylon, in the Society's museum, he was convinced that the Asiatic root would prove an article of considerable value to dyers. He described the colour as being disseminated throughout the whole of the wood, bark, and roots; and suggested that experiments should be made on the relative quantity of colour in each of these parts respectively. Mr. Solly then mentioned that, as the root contains not more than seventeen per cent of useful colour, it might prove more convenient to import the watery extract instead of the whole root or stem, which plan would diminish the cost of the dye. The extract is well known to the natives of India, being the *horzis* or *rusot* of their medical writers; and might, no doubt, be easily prepared in large quantities. (*Athenæum*, Dec. 1. 1838, p. 859.)

## CAPPARIDA'CEÆ.

*Cápparis spinòsa*, Arb. Brit. p. 314. fig. 63., and Hort. Lig. p. 5.—The stool of the plant which we have mentioned as having been sown by Bradley, on the garden walls of Camden House, in 1716, and which was killed by a severe frost in 1799, has lately been presented to us by Miss Teak, the present occupier of Camden House, now a highly respectable school for young ladies. The root, or stump, is about 6 in. long, and  $1\frac{1}{2}$  in. in diameter in the thickest part, very tortuous, and with numerous knots and protuberances. — *Cond.*

## ANACARDIA'CEÆ.

*Amyris polygama*, Duvaúa dépendens Dec., Arb. Brit. 558., and Hort. Lig. 24., is a remarkably stiff-growing tree, and seldom loses its leaves in the winter season.—*W. F. S. Abbotsbury, Dorsetshire, Dec. 1838.*

*Sophòra japònica pèndula* first appeared in the French nurseries in 1813 or 1814. M. Joly, rural architect and cultivator, Rue des Fossés-Saint-Marcel à Paris, and M. Jouet, pépinieriste, à Vitry-sur-Seine, disputed the honour of having found it in a bed of seedlings. They may both have found it at the same time. (*Annales d'Hort. de Paris*, vol. xix. p. 26.)

*Cýtisis Labúrnum var. purpuráscens*, Arb. Brit. 590.; Hort. Lig. 27.; Purple Laburnum, *Cýtisis Adàmi* Poit.; is generally considered a hybrid; but the following facts will show that it is rather to be looked on as a particular kind of sport. In 1825, D. Adam, nurseryman, at Vitry, budded, in the shield manner, the purple cytisis on the *Cýtisis Labúrnum*. The bud remained dormant for one year, that is to say, it adhered, but did not develop its eye into a branch; but during that same year the plate of the shield was found covered with an irregular roughness round the eye, which roughness gradually formed into buds, germs, or small eyes; these small eyes the second year became elongated into branches of the purple cytisis, one branch excepted, which was much larger, longer, more vigorous, more vertical, and of quite a different aspect from the rest, bearing a most particular resemblance to *Cýtisis Labúrnum*, apparently not retaining anything of its parent, the purple cytisis (*C. purpúreus*). However, the leaves of this novelty were not quite so large as those of *C. Labúrnum*, and were devoid of its pubescence. The inflorescence was almost the same as that of *C. Labúrnum*, but the racemes were not quite so long, nor so well furnished with flowers, and these were not quite so large, were of a pale dull yellow colour, tinged with red, and in short, quite a new colour of its kind. Such is the *Cýtisis Adàmi* (*C. Labúrnum purpuráscens*, *Arb. Brit.* as above).

This new branch was multiplied by grafting, and soon spread extensively among commercial gardeners. In some places it remained pure; but at Rouen, in the Jardin du Roi at Paris, and in the Domaine du Roi at Neuilly, after remaining pure some years, it suddenly produced, from one of its axillary buds, a branch having the leaves and flowers of the true *Cýtisis Labúrnum*. The only instance known of a similar manner of sporting is in the Bizarrerie and Bizarde oranges. At Rouen one plant has produced the true *Cýtisis purpúreus* in one place, and the true *Cýtisis Labúrnum* in another. (*Annales d'Hort. Paris*, vol. xxii. p. 8.) It is unnecessary to remind our readers, that this has been the case in several instances in England.

## ROSA'CEÆ. § Amygdàleæ.

*Prúnus Cocomílla*, *Arb. Brit.* 691., and Hort. Lig. 35. — In the *Penny Cyc.*, art. Cocomiglia, it is stated, that this species bears a general resemblance to the cultivated plum; that it is found on mountains in Calabria as high as 3000 ft., and that with respect to its medical properties, as there is a very close affinity between the Cocomiglia, the sloe, the bullace, and the common cultivated plum, it is highly probable, that similar medical qualities are possessed by all of them. The bark should be collected in the months of November, December, or January; that of the root is principally employed



either in decoction or extract, and it is generally preferred to cinchona for the cure of the intermittent fevers of Calabria. Its valuable qualities are attested by Savaresi, Polizzi, Tenore, and other Neapolitan physicians.

*Prunus myrobálana*, *Prunus doméstica myrobálana*, *Arb. Brit.* 688., Hort. Lig. 35., has been used as a stock for the peach, nectarine, and apricot in the nursery of M. Catros at Bordeaux, since the year 1802. The seeds were at first received from North America; only two plants were raised from them, which were preserved as stools, and from them the stocks used in the Bordeaux Nursery, and all those sold to other nurserymen, have been raised. M. Catros died on the 11th of November, 1836, and the nursery business is now carried on by his nephews, MM. Girard frères, who say that they have myrobálans with yellow fruit, red fruit, and fruit of different shades of colour. (Query bullaces.) The myrobalan, MM. Girard observe, has the advantage of growing vigorously in every soil. It makes an excellent stock for plums, as well as peaches and apricots, and more particularly for the Reine Claude (green gage), which, grafted on the myrobalan standard high, produces magnificent fruit. (*Annales d'Hort. Soc. de Paris*, vol. xxi. p. 304.)

§ *Ròseæ.*

*Sporting of Roses*, *Arb. Brit.* 748. — Mr. Willison of the New Garden Nursery, near Whitby, cultivates extensively the different varieties of Moss Rose; and he was so much surprised to find one sort sport into another, as to induce him to form the opinion, “that many of the new kinds of moss, and other sorts, are only sported shoots of old varieties.” (*Marnock's Flor. Mag.*, vol. iii. p. 74.) We have no doubt whatever of the correctness of Mr. Willison's opinion. Almost all variegated varieties of ligneous plants have been obtained in this manner, and in particular all our variegated hollies. New kinds of Chinese chrysanthemums, and other herbaceous plants, are also often so obtained, as well as from seed. — *Cond.*

CAPRIFOLIA`CEÆ. § *Lonicææ.*

*Leycestèria formòsa*, *Arb. Brit.* 1060. fig. 827., and Hort. Lig. 65. — This fine shrub flowered in the autumn of 1838, in the open air, in the Horticultural Society's Garden, and also the same season, under glass, in the Edinburgh Botanical Garden. It is figured in the *Bot. Reg.* and the *Bot. Mag.* for Jan. 1839, as mentioned in our *Flor. Not.*, p. 71. *L. formòsa* turns out to be not quite so beautiful as was expected; but to compensate for this, it appears to be quite hardy, of the easiest culture and propagation, and an evergreen. It may, therefore, in a few years, be found on our cottage walls and arbours, along with the common honeysuckle, the China rose, *Lonicera flexuòsa*, and *Wistària sinénsis*. — *Cond.*

OLEA`CEÆ. § *Syringææ.*

*Syrínga*. — It is recommended to graft the different species of lilac on the *O'rnus rotundifòlia*, or flowering ash, in order to retard the appearance of the blossoms, and so prolong the season of that very beautiful shrub; but whether the lilacs would endure many years on this ash is very doubtful, since the period of the movement of the sap in the two trees is very different; the lilacs expanding their leaves fully a month before the ash trees. (*Annales de la Société d'Hort. du Nord*, as quoted in *Annales d'Hort. de Paris*, tom. xx. p. 88.)

§ *Fraxíneæ.*

*Fráxinus oxyphýlla* Bieb., *F. excélsior parvifòlia oxycárpa*, *Arb. Brit.* 1230. fig. 1053., and Hort. Lig. 81. — The Hon. Mr. Fox Strangways, in sending us some seeds of this species of ash, which he had received from the Crimea, observes that he thinks “that all the small-leaved ashes, which he has seen in the south of Europe, viz. *F. oxyphýlla*, *F. oxycárpa*, *F. rostràta*, *F. lenticifòlia*, &c., are but one species, which extends from the Black Sea to Italy; and that *F. excélsior* seems not to exist near the Mediterranean

*F. excelsior pëndula adpréssa*.—D. Maclean, Esq., of Forres, has sent us a portrait of a very curious pendulous-branched ash, which he discovered, some years ago, in Argyllshire. "It grew," Mr. Maclean observes, "within a few yards of the sea, on the banks of one of the numerous and very picturesque inlets, which everywhere indent the coast of Argyllshire. It was completely hidden from view by other trees, such as ash, alder, &c., and a fine spring gushed out close to its roots. I had a space cleared all round it, and should have been tempted, had I not been on the point of parting with the property, to have transplanted it to the immediate neighbourhood of my residence. In 1835, the property passed to other hands, and I know not whether the tree is still in existence. It was about 25 ft. in height, and, when I last saw it, appeared to be growing vigorously. Its habit of growth certainly struck me as being very singular, as, indeed, you may see by the sketch, which is a tolerably faithful portrait."—*D. M. Forres, Dec. 6. 1838.* This sketch we intend to have engraved in the course of the summer.

In the common pendulous-branched ash, the young shoots come out of the stems horizontally, and, in growing downwards, form large convex curves, as they depart from the main stem, much in the same manner as in the pendulous shoots of the weeping willow. These shoots stand out from the trunk of the tree, so as leave a naked space all round it, which, when the tree has grown a few years, is commonly used as a shady bower, or place for a seat; but in the sketch sent, the young shoots hang down close to the trunk or main stem, from the top of the tree to the ground, turning up at the points, so as to form concave curves, in a manner different from every pendulous tree that we know of, except, perhaps, *Sophora japonica pëndula*. This appearance might, perhaps, be called appressed pendulous. It appears, at all events, to be a very distinct variety of pendulous ash, from that in common cultivation; and, should this paragraph, by any chance, meet the eye of the present proprietor of this tree, we trust he will be induced by it to send scions to the nearest nurseryman, in order that it may be propagated, and introduced into commerce. In thanking Mr. Maclean for his communication, we have to beg that he also will cooperate with a view to this end.—*Cond.*

#### ELÆAGNA'CEÆ.

*Hippóphæe Rhannöides* is abundant in the Alps, on the borders of streams and rivers, and is found on the Rhone, from the Valais to Dauphiné. In Lapland and Holland it is planted on river banks, to protect them from the ravages of floods. The berries, gathered about the 24th of September, will be found quite ripe, and the pellicle contains a yellow dye, soluble in ether, and which, when applied to silk or cotton, does not wash out with common water. Rousseau relates a story of his eating the berries, and being thought to have poisoned himself. He had eaten 15 or 20, but found no inconvenience. (*Annales d'Hort. de Paris*, tom. xix. p. 339.)

#### EUPHORBIA'CEÆ.

*Euphórbia*.—I recommend, as shrubby plants, *E. venèta*, *E. Charàcias*, *E. palústris*, and *E. amygdalöides*.—*W. F. S. Abbotsbury, Dorsetshire, Dec. 1838.*

#### URTICA'CEÆ.

*Mòrus*.—M. d'Arcet has found that the leaves of the white mulberry may be eaten as spinach, as may those of the black mulberry and the maclura. The leaves of the last two trees, when properly seasoned, are said to make a dish by no means disagreeable. (*Annales d'Hort.*, tom. xix. p. 124.)

*Maclúra aurantiàca*.—There are both male and female specimens of this tree in the Botanic Garden at Avignon, which have ripened fruit, from which young plants have been raised. There are also in the nursery of M. Noisette,

in Paris, large male and female macluras, which, in 1837, produced ripe fruit with perfect seeds. (*Annales d'Hort. de Paris*, tom. xxi. p. 215.)

ULMA'CEÆ.

*Ulmus*.—Elm leaves, as food for cattle. M. Poiteau, while on a horticultural tour from Paris to Fontainebleau and Barres, between the latter place and Nemours, found the boys and the girls of the neighbouring villages perched on the elm trees which line the public road; and not only gathering the leaves, but breaking down the young shoots, in order to carry them home as fodder for cows. Many trees had not a single leaf, except at the extremities of the branches, which could not be reached by hand. M. Poiteau was informed that this was the custom of the country; and that the elms on various properties are kept pollarded, in order to facilitate the taking of the leaves and young shoots by means of a short ladder. The leaves and shoots are found highly nutritive to cattle, whether eaten in a green state, or after being dried, and stacked for winter use. (*Annales de la Société d'Hort. de Paris*, &c.)

TAXA'CEÆ.

*Salisbùria adiantifòlia fœ'mina* grows vigorously in the nursery of M. Godfroy, at Ville d'Avry; but, having only been lately received, it has not been much propagated. (*Annales d'Hort. de Paris*, 1837.)

It grows readily from cuttings of the ripened young wood taken off with a heel, planted in sand in a sandy border, and covered with a hand-glass. There are plenty of young shoots pruned off annually from the female *Salisbùria* in Kew Gardens, and we are therefore surprised that the tree is not propagated in any of the nurseries, except at Messrs. Loddiges. — *Cond.*

PINA'CEÆ.

*Pinus*, *Abies*, *Picea*, &c.—In the *Annals of Natural History*, vol. ii. p. 163., is a paper entitled, "On the Genera *Pinus* and *Abies*, with Remarks on the Cultivation of some Species. By Capt. S. E. Cook, R.N. Read at the British Association, Newcastle-upon-Tyne, in August, 1838." The author proposes to divide the seventy species described by botanists into five groups: 1. those of Old America; 2. those of the Rocky Mountains, which divide the Atlantic from the Pacific, and which, as most of the species were made known to us by Mr. Douglas, he proposes to call the "Douglas Group;" 3. those of the uplands of Mexico; 4. those of the Himalayan Mountains; and, 5., those of Europe. In speaking of the European group, Capt. Cook considers *P. uncinàta* and *P. hispànica* as distinct species; and in which opinion we think, judging from the plants raised from seeds received from Capt. Cook, and now growing in the Horticultural Society's garden, he is mistaken; or, in other words, he considers as species what we consider only as varieties. We decide on this point from the form of the buds, which, in all the varieties of *P. Larício*, including *P. Larício hispànica*, have the buds white, resinous, and terminated with a long point, like that of a camel-hair pencil; while in all the varieties of *P. sylvéstris*, including *P. s. uncinàta*, the buds are short, blunt, brownish, and resinous. See *Arb. Brit.*, p. 2153. and p. 2200., with the different figures showing the buds of the different sorts.

In the *Arboretum*, p. 2209., we have stated, on the authority of La Perouse, that Capt. Cook's *P. hispànica*, which is La Perouse's *P. pyrenàica*, is found in the Pyrenees, between the rivers Lassora and Cinca; but Capt. Cook says that this forest is Spanish, and not French. We are much obliged to Capt. Cook for the correction; but it does not at all affect the question as to *P. hispànica* being a variety of *P. Larício*, which is what we deduce from the evidence of living specimens acknowledged by Capt. Cook to be genuine, altogether independently of geographical distribution. Our readers, by comparing the tree named *Pinus hispànica* in the Horticultural Society's garden, with *P. Larício*, *P. L. romàna*, and *P. taùrica*, in the same garden; and *P. uncinàta*

with *P. Mughus* and *P. pumilio*, may judge for themselves. Capt. Cook alleges that it is impossible to form a mature judgement on the disputed point, without seeing full-grown trees in their native habitat; and in this we also differ from him: but we state what he alleges, in order that those who take an interest in the subject may bear his opinion in mind, as well as ours, in forming their own. (See *Arb. Brit.*, p. 2210.)

Capt. Cook says, "We do not adopt the fanciful term of *Picea*, and divide the class, because of the difficulty of making a true demarcation," &c. The readers of the *Arboretum* are aware that nothing can be more decided than the difference between *Abies* and *Picea*; the former always having the cones pendulous, and the latter always having them erect, differences that may be known even by a general observer at a considerable distance. The division, however, was not ours, but that of Professor Link, who, in dividing the species, adopted the old Latin names used by the Romans for the trees, calling the spruce fir *Picea*, and the silver fir *Abies*. We have followed Link in separating the spruce from the silver fir, and we feel perfectly confident that every practical planter and gardener will thank us for so doing; but we have followed Linnæus in applying the name of *Abies* to the former, and *Picea* to the latter.

Speaking of the *Abies cephalonica*, Capt. Cook considers it a variety of the silver fir; and he adds, "there can be no doubt that the same species forms the capping found by the French *savans*, who have recently visited that country, to cover the loftiest summits of Mount Taygetus, in the centre of the Peloponnesus." (*Ann. of Nat. Hist.*, ii. p. 172.) On turning to the work of the French *savans*, alluded to by Captain Cook, viz. *Expédition Scientifique de Morée, &c.*, Paris, 4to, 1832, we find that *Pinus Picea* forms a region, or belt, around the summit of Mount Taygetus, up to the limits of perpetual snow. The tree is fast disappearing there, but thick forests of it still remain on the Malévos de Tzaconie. Mount Olenos, also, abounds in it; and it is there called the wild cedar. (*Expéd. Scien. de Morée*, tome iii. partie 2de, p. 274.) In this conjecture Capt. Cook may be right, as we have never seen what we are certain are the cones of *Abies cephalonica*, though we expect soon to do so, as will appear from a future paragraph in this article. We are further convinced of the probability that Captain Cook's conjecture is right, from having, since the preceding part of this paragraph was written, seen the original letter from Sir C. J. Napier to H. L. Long, Esq., dated Argostoli, Oct. 2. 1825, which accompanied the seeds. In that letter General Napier says: "The cones were picked up on the Black Mountain, at about 5000 ft. above the level of the sea. They call them *Ελαρη* (the silver fir). The *Πευκη* (the spruce fir), I am told is not found here." Mr. Long was not able to find this letter when he first gave us information on the subject, otherwise we should have placed the Cephalonian fir in the division *Picea*. Our reasons for placing it under the division *Abies* will be found in the *Arboretum Britannicum*, vol. iv. p. 2326. — *Cond. Feb.* 6. 1839.

Capt. Cook concludes his paper by a powerful exhortation to plant larch; *P. Cembra*, of which "the timber, perhaps, is superior to any other species;" *P. uncinata*; the spruce and silver firs, &c. On the whole, we have been much gratified by the perusal of the article; and we think Capt. Cook deserves well of the public, for having kept alive the present attention, which is general among planters, to the *Abietifera*.

*Increase of Soil from the Falling of the Leaves of Pines and Firs.* — These leaves resist decomposition for a number of years, on account of the resinous matter which they contain, and the wind taking no hold of them from their needle-like shape. They generally lie where they fall, and thus accumulate to a considerable thickness; destroying all vegetation, except that of trees already established. In the Forest of Fontainebleau, M. Poiteau found that the leaves which had dropped from a plantation of *Pinus sylvestris*, about 25 ft. high, had formed a stratum between 6 in. and 8 in. in thickness; and nineteen

years afterwards, when he examined the same plantation, he found the trees from 45 ft. to 60 ft. high, generally thicker than a man's body, and the decaying stratum of leaves so much increased, that several rocks, which before appeared 2 ft. above the soil, were no longer visible. (*Annales de la Société d'Horticulture de Paris*.)

*The Pine and Fir Tribe*, though they will succeed perfectly well in poor sandy soil, by no means thrive in poor calcareous soils. M. Vilmorin has sown and planted the pine and fir tribe on the poor sandy wastes of his estate, Les Barres, near Montargis, on the road to Lyons, which have thriven wonderfully: on the same estate, there are some poor calcareous soils, and on these M. Vilmorin has not been able to get the pine and fir tribe to succeed at all. Nevertheless, on the chalks of Champagne there are pine woods; though it is acknowledged, on all hands, that the pines and firs on chalk grow much more slowly, when young, than they do on either sand or loam. (*Poiteau in Annales de la Société d'Hort.*)

*P. sylvestris* (the *Scotch Pine*) as compared with *P. Pináster* (the *Pinaster*). — The Forest of Fontainebleau contains nearly 30,000 acres, of which above 25,000 are covered with pines of different species, all planted. It is among the more ancient of these plantations that the vast superiority of the *Pinus sylvestris* appears over every other species, and more especially over the *P. Pináster*. The pinaster grows more rapidly when young, but the Scotch pine soon overtakes it, and, after a certain number of years, attains a higher elevation, and still continues to grow. The Scotch pine has a trunk always straight and erect, with a reddish grey bark, scaly, but only slightly furrowed. The pinaster, on the contrary, never has a straight trunk, while its bark is much thicker, rougher, more deeply furrowed, and of a darker grey, than that of the Scotch pine. The two trees can be distinguished at a considerable distance by a bare inspection of the bark. (*Ann. de la Soc. Hort. Paris*.)

*P. Pináster var. major*, and *P. Pináster var. minor*. — Cones of these two varieties have been sent us by Mr. Strangways, who received them from Naples. The former is nearly twice the diameter of, and about a third part longer than, the latter. The terminations of the scales are particularly prominent and pointed, in both varieties; and on the lower part of one side of the cones of *P. minor* they are turned down exactly in the manner of those of *P. sylvestris uncinata*. Of course this is only an accidental circumstance, which often happens to the cones on one part of a tree, and is totally wanting on those of the other parts. — *Cond.*

*P. Pináster Escarèna* (so named by Risso, in honour of his friend Count Escarena, on whose estate this pine was found), Arb. Brit. 2214., Hort. Lig. 119. — This variety of *Pináster*, recorded in the *Arboretum Britannicum* on the authority of the name placed on the plant in the Horticultural Society's garden, and also on that at Dropmore, the Duke of Bedford has discovered not to be the plant named *P. Escarèna* by M. Risso. His Grace passed the winter of 1837–8 at Nice, and there saw M. Risso, who first discovered and gave the name to this alleged new species, of *Pinus*; and from him procured specimens, which he brought to England. These specimens Mr. Forbes, the Duke of Bedford's gardener at Woburn, considers to be nothing more than the Scotch pine; and a tree of this species in Mr. Harrison's pinetum, at Cheshunt, is said to be the true *Pinus Escarèna* of Risso. It seems that the Earl of Aberdeen, who first brought the seeds to England, committed them to the care of his gardener; who, in sowing them, confounded them with the seeds of some other pines. The whole matter, His Grace the Duke of Bedford informs us, will be set to rights in the catalogue of the pinetum at Woburn, which is now preparing for the press under His Grace's direction.

Since the above was in type, we have seen Lord Aberdeen, who informs us that, when he first saw the *P. Escarèna* at Nice, he thought it very like the Scotch pine, and was quite surprised when he saw that name applied to the tree at Dropmore, and to that in the Horticultural Society's garden. His

Lordship says that the tree at Mr. Harrison's is undoubtedly the true *Escarèna*, and, as he thinks, is nothing more than a variety of *Pinus sylvéstris*.

We have subsequently (Feb. 15th) received a copy of the *Pinetum Woburnense*, but too late to make any use of it in the present Number.

*P. Pináster Aberdòniæ*. — As the variety of *Pináster* to which the name of *Escarèna* has been given is a very distinct one, we propose, in future to distinguish it as *P. Pináster Aberdòniæ*, in honour of the nobleman who first introduced it.

*P. Llaveàna*, *Arb. Brit.* p. 2267., *Hort. Lig.* p. 120. — We figured and described this species from the young plant in the Horticultural Society's garden, and from a cone sent to us by M. Otto of Berlin. M. Otto could give us no information whatever respecting the species, except that he had received the cone from a traveller in Mexico. It now turns out that this traveller had made a mistake, and sent M. Otto a cone of a different species. For this statement, we have the authority of M. Otto's letter of Nov. 27. 1838. In that excellent publication the *Linnæa*, part. iv. of vol. xii., published in the autumn of 1838, is a paper by the editor, Dr. von Schlechtendal, entitled "Preliminary Information on the Coniferæ of Mexico," of which the following is an outline, with a description of *P. Llaveàna*, and of two new species, *P. oocárpa*. and *P. Ayacahuíte* : —

§ *Leaves standing singly.* (*Abies* and *Picea* of *Arb. Brit.*)

*Pinus religiòsa*, *Linnæa*, vol. xii. p. 486. (*Picea religiòsa*, *Arb. Brit.* p. 2349.)

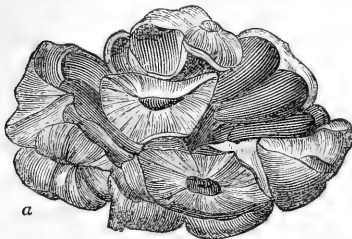
*Pinus hirtélla*, *Linnæa*, vol. xii. p. 487. (*Picea hirtélla*, *Arb. Brit.* p. 2349.)

§ *Leaves standing Three in a Tuft.*

*Pinus Teocòte*, *Linnæa*, vol. xii. p. 487.; *Arb. Brit.* p. 2266.

*P. pátula*, *Linnæa*, vol. xii. p. 487.; *Arb. Brit.* p. 2267.

*P. Llaveàna* Schiede, in *Linnæa*, vol. xii. p. 488.; *Arb. Brit.* p. 2267. — "This beautiful and remarkable species," observes Dr. von Schlechtendal, "was first raised in the Berlin Botanic Garden, from the seeds of a cone which Dr. Schiede sent to the editor of the *Linnæa*. The species was introduced into England from the Berlin Garden, and was described and figured by Loudon in his *Arboretum Britannicum*, p. 2267., but, unfortunately, with a wrong cone; which, from its appearance, probably belongs to the foregoing species [*P. pátula*.] *P. Llaveàna* is the species that has very well tasted edible seeds, which are sold cheap in Mexico under the name of *Piñones*. Schiede found whole forests of this tree scarcely 30 ft. high, between Zimapan and Real del Oro; it is also cultivated occasionally in gardens. The leaves, which are only 1½ in. long, are generally slightly twisted, pointed, strong, and



23



two-furrowed below with a sharp, keel-shaped, projecting midrib. The cones are small, consisting of very few scales, which are about 1½ in. long, roundish, and obtuse. The scales are keel-shaped below, deeply concave, with two deep

receptacles for the seeds. The rhomboidal enlargement of the points of the scales is of a pale brown colour, faintly shining, the diameter about 9 lines, and the length about 6 lines; the middle compartment is of a darker brown, and only about 3 lines broad; a projecting and tolerably sharp band runs across the rhomboidal termination of the scales, by which the whole middle compartment is elevated; some inconsiderable and more or less distinct bands run from the upper point, and from the under edge to the middle compartment. The outermost as well as the central scales are usually empty; and

the seeds in the others, which are of a dark grey or brownish colour, are without wings, and of an egg-shape reversed, about 6 or 7 lines long, and about 4 lines thick at the upper end, but diminishing in size towards the lower extremity, which is obtuse. Schiede named this interesting species in honour of Paul de la Llave, who well deserves the honour, for what he has done for the flora of Mexico." (*Linnæa*, vol. xii. p. 489.) A notice to the same effect as the above, and also by Professor von Schlechtendal, is given in the *Garten Zeitung*, No. 37., for 1838, p. 293. ; and M. Otto, in the letter already referred to, in which he explains the origin of the error which he inadvertently led us to commit, kindly sent us a coloured drawing of the cone, of which *fig. 23.* is an engraving of the same size : *a*, cone ; *b*, a seed.

§ *Leaves Five in a Tuft.*

*Pinus Montezùmæ*, *Linnæa*, vol. xii. p. 489. ; *Arb. Brit.* p. 2272.

*P. leiophylla*, *Linnæa*, vol. xii. p. 490. ; *Arb. Brit.* p. 2273.

*P. oocarpa* Schiede ; *Linnæa*, vol. xii. p. 491. ; not in *Arb. Brit.* — " Schiede found this tree, from 30 ft. to 40 ft. high, growing abundantly between Ario and the volcanic mountain Jorullo ; and not only in the temperate, but also in the warm, regions, where it grows in company with the fan palm. The leaves, which are from 8 in. to 11 in. long, and the single short cones, broad below and pointed above, characterise this tree ; which evidently comes the nearest to *P. Montezùmæ*, with which, also, it nearly corresponds in the scales of the branches. When the cone is closed, the enlargement of the scales appears sometimes tolerably elevated and equal-sided, and sometimes of an irregular four-cornered or many-cornered shape. Elevated bands run to the middle point from the corners, so that the whole end of the scale looks slightly pyramidal. The largest cone which we saw, and which had just begun to burst open, was about  $2\frac{1}{4}$  in. long, and in breadth below  $1\frac{3}{4}$  in. The leaves are tolerably flat on the upper side, with dotted parallel lines ; and a strongly keeled, two furrowed, projecting midrib below, with small cartilaginous teeth, not very close together, at the edges, which renders them somewhat sharp." (*Linnæa*, vol. xii. p. 492.) The cones of a pine received from Mexico, and distributed by the Horticultural Society under the name of the "*Ocote* pine of the Mexicans," agree remarkably well with the above description, more so than they do with *P. Teocôte* Lamb., *Arb. Brit.* p. 2266. We shall give an engraving of this cone in a future Number.

*P. Ayacahuite C. Ehrenberg* ; *Linnæa*, vol. xii. p. 492. ; not in *Arboretum Britannicum*. — This is the most remarkable species of the division, and it is allied to *Pinus Stròbus*. " My highly valued friend Charles Ehrenberg found this tree 100 ft. high, at Omitlan, near Hacienda de Guerrero. It is called Ayacahuite, and also Piñones, because it was believed to have originated in that species (*P. Llaveàna*), though wrongly, as the seeds of the present species are winged. The leaves are in fives on small spur-like protuberances, which, when very close together, make the twig look stunted, and very crooked. Each leaf is from 3 in. to 4 in. long, and about a third of a line broad ; flat on the back, but with a sharp projecting keel-like midrib, and two furrows. The leaves are whitish when young, and furnished with sharp thickened small teeth, not very close together, on the margin, towards the points. The youngest twigs have very short reddish brown hairs, only perceptible with a magnifying glass, but which do not last long. The scales on the branches are short, of a longish three-cornered shape, pointed, and afterwards bent back ; the sheaths are short, and do not lie close to the leaves. The cones are more than a foot long when at their full growth (we saw one 13 in. long), about 3 in. in diameter at the base, and tapering towards the point. The scales are about 2 in. long, standing open, with their points more or less bent downwards ; the rhomboidal surface is much longer than it is broad, intersected by many wrinkles lengthwise, of a dull greenish and yellowish brown colour. (In *P. Stròbus* the points of the scales are bluntly rounded, obtuse, and stand upright.) A great deal of resin exudes from the whole

cone, as in *P. Ströbus*. The seed is winged, and is only 1 in. long; towards the top, where it is broadest, its width is from 8 to 12 lines. It is small in proportion to the cone. The wing has almost the appearance of the upper wings of many small moths. It is brownish, with dark stripes running lengthwise. The receptacle is only a few lines long. The cones are often either bent or crooked, which is also the case with those of *P. Ströbus* and many others. The scales have not their points always bent down, but some of them stand out horizontally, while the lowest scales are bent quite backwards." (*Linnaea*, p. 492.)

We have translated the above descriptions at length, in the hope that they may be of some use to the botanical collectors now in Mexico, or about to be sent thither. In our next Number we shall translate the descriptions of *Cuprëssus thurifera* H. B. & Kunth, *C. sabiüoides* H. B. & Kunth, *Juniperus mexicanä* Schiede, *J. florida* Schl., *J. tetragöna* Schl., and *Täxus globösa* Schl.

The following paragraphs respecting the *Abiëtinae* are collected from different sources:—

*P. nigricans* (*P. Laricio* var. *austriaca*, *Arb. Brit.* p. 2205.) has remarkably strong buds, silvery white, as well as the sheaths of the leaves, which are stiff, long, and sharp, and expand almost horizontally round the shoot. This, with the darkness of the foliage, makes the white silvery young shoot in the centre very conspicuous. In most pines, the leaves tend forwards like a cup, so as to hide the young shoots. The bud itself is cylindrical-topped, with a low cone, terminating in a long point. The trunk of *P. nigricans* is larger in bulk than that of *P. sylvëstris* in the Austrian forests. — *W. Fox Strangways*, *Dec.*, 1838.

We have since been favoured by Mr. Strangways with a branch of *P. nigricans*, the buds of which confirm us in our opinion that it is a variety of *P. Laricio*, as indicated in the *Arboretum Britannicum*. — *Cond.*

*P. pithyüsa*. — A cone, with this name attached, has been sent us by the Hon. W. F. Strangways. The termination of the scales is, in form and smoothness, like that of those of *P. halepënsis*, *Arb. Brit.* p. 2231., and the cone has a strong woody peduncle, like that species; whence we conclude the tree to be either identical with *P. halepënsis*, or a variety of it. Mr. Strangways received the cone from Circassia.

*P. përsica?* — To Mr. Strangways we are also indebted for a cone with this name attached. The shape is somewhat like the cone of *P. Pineä*, and the seeds are large, with gibbous wings. Some seeds of this pine have, we believe, come up in the Horticultural Society's garden.

*A'bies commünis* var. *pëndula*. — The Earl of Aberdeen informs us that M. Risso told him, in 1825, that he had seen a very remarkable variety of the common spruce, with drooping branches, in some elevated parts of the mountains about Nice; but that he had not then had an opportunity of getting plants or seeds. This variety may be worth the attention of cultivators.

*A'bies cephalönica*, *Arb. Brit.* p. 2325., and *Hort. Lig.* p. 122. — In the summer of 1838, through the kindness of General Sir Charles James Napier, two hogsheads of cones, collected in the Island of Cephalonia, from what were supposed to be trees of the above species, were shipped for us at Corfu. When they arrived in the port of London we examined them, and found that they had fermented during the voyage, and were useless. We further observed that the cones were, to all appearance, those of the common silver fir. We were confirmed in this opinion by some small branches, with leaves, which were attached to some of the cones, and one of which branches is in our possession. Under these circumstances we declined paying the duty (6*d.* per lb.); and the nearly rotten cones were, of course, thrown away by the custom-house officers. General Napier kindly wrote again to his friend in Corfu, and a third cask of cones arrived in November. These had still the appearance of being the cones of the common silver fir; but, as there were no branches or leaves among them, we thought it possible, as suggested in Capt. Cook's paper, that the *A'bies cephalönica* might not be an *A'bies*, but merely a variety of *Picea pectinätä*. The cones being in better preservation than those



received before, we gave the bill of lading to Mr. Charlwood, who has paid the duty and all expenses; and, having taken possession of them, is now selling them by retail. In the mean time, we have applied, through a friend of General Napier's, and also through H. L. Long, Esq., for specimens of all the pines and firs in Cephalonia, with the cones attached to branches; and, when these specimens arrive, we hope to be able to determine whether what we have called *Abies cephalonica* is an *Abies* or a *Picea*; and, if the latter, whether it is a distinct species, or only a variety of the silver fir.

*Pinsapo*. See Mr. Lawson's paper, p.109.

*Picea Nordmanni* Steven will be described and figured in a future Article.

#### ART. VII. *The recent Plantations in Kensington Gardens and Hyde Park.* By the CONDUCTOR.

WITHIN the last two or three years, government has removed the old yew hedges, shrubs, and other undergrowths, from the west side of Kensington Gardens, leaving only the trees; and, in other parts of the gardens, strips and masses of young plantation have been formed, consisting of trees and shrubs of various kinds. In Hyde Park, during last year, and in the present spring, various clumps, masses, and belts of young plantation have been formed, or are now forming, entirely of forest trees; and some rows of trees, as well as scattered single trees, have also been planted there. As some part of these alterations are, in our opinion, made in extremely bad taste, and not even calculated to effect in the best manner the object which the government appears to have in view, we submit a few remarks on them, in the hope that they may attract the attention of those who have influence in such matters. We do this as a matter of duty, and with very great reluctance; because, during the preparation of our *Arboretum Britannicum*, we received most valuable information, and every assistance that we asked for, from the Office of Woods and Forests; and it would, therefore, have been incomparably more agreeable to us to praise, than to blame, anything done under the direction or sanction of its commissioners.

The removal of the old yew hedges from Kensington Gardens we regret, as destroying a specimen of ancient gardening, which it would have been interesting to preserve and heighten, for the sake of its antiquity; and this seems also to have been the opinion of government three or four years ago, when they planted a number of young yew trees in the gaps which time and neglect had made in these hedges. The removal of the deciduous shrubs we do not regret, because these, being under the shade and drip of the forest trees, had become unsightly objects; and, indeed, no shrubs thrive and look well in such situations but evergreens. It is clear, however, from the removal of these hedges and shrubs, that it is now the intention of government to give Kensington Gardens a park-like character, rather than that of a pleasure-ground, which is characterised by flowering and evergreen shrubs, in addition to ornamental trees. Without stopping to enquire into the propriety of this change of character in these gardens, we shall assume that in future they are to be treated in the manner of park scenery of a polished character; and this will furnish us with a principle by which to test the plantations subsequently made in these gardens.

These plantations are, chiefly, a belt along the southern boundary, extending nearly the whole length of the gardens, and one on the north side, extending nearly half the length. Both these plantations are very thickly planted; and, in that on the south side, a large proportion of the plants are shrubs. Now, assuming it to be the ultimate intention to give the gardens a park-like character, and consequently to have no shrubs, but only scattered trees in the places where these plantations are made, our opinion is that single trees ought

to have been planted there at once; and that no strip or mass of plantation, with its formal boundary fence, was at all necessary to shelter or bring forward these trees. A very obvious and desirable improvement, for which all praise is due to government, is the removal of the brick wall which formed the southern boundary fence to the gardens, and the substitution of an open iron railing in its stead. The object in doing this must have been to allow the spectator within the gardens to get occasional glimpses, through the open railings, of the scenery in the park without; and to admit the spectator in the park to get occasional glimpses of the scenery in the garden, through glades of turf, in a direction oblique to the line of open fence. Now, by planting a thick belt along the inside of the open fence, these objects are rendered as nugatory as if the brick wall were still remaining, the fence and everything beyond it being completely concealed from the spectator within; while the spectator without will see nothing within the open railing, but a thick mass of plantation. If, on the contrary, only single trees and small groups had been planted in the situation of the belt, the contemplated effect would have been produced from the beginning; whereas, as things are at present, it will not be obtained for several, perhaps twenty, years, when the belt is thinned out.

In Hyde Park, during the spring of 1838, an avenue of elm trees, and a number of scattered single trees, were planted; and we have nothing to object to them, unless it be, that they would have made much more vigorous growths during the summer, had they been planted in the preceding autumn. When trees are planted in October, the roots begin growing immediately; and the tree, being established before winter, is ready to shoot out branches with the first approach of spring. A tree planted in spring, say in February or March, has the whole of its sap speedily put in motion; and, being thus forced to develop its buds, while its roots are not yet in a state to imbibe nourishment from the soil, its shoots are comparatively weak and inefficient. In autumn, when the top of the tree is in a dormant state, and when the temperature of the atmosphere is below that of the soil, the whole of the energies of the tree are directed to the formation of roots. In spring, on the contrary, when the temperature of the atmosphere is greater than that of the soil, the energies of the tree are directed to the development of the buds, in the form of leaves and shoots, while very little addition is made to the roots till the return of the sap after midsummer. Hence are deduced, from a knowledge of vegetable physiology, as well as from experience, the immense advantages of planting trees, and especially large trees, in autumn rather than in spring. Planting in mid-winter is scarcely, if at all, better than planting in spring; because both the roots and the top of the tree are then completely in a dormant state, and the soil much too cold to excite the roots into action.

In Hyde Park, a number of roundish or oval clumps, and some irregular and continuous belt-like masses, have been formed during the last year and present spring, which, in our opinion, greatly disfigure the Park, and will do so more and more every year, as they advance in growth. This mode of planting appears to us like going back a hundred years, in point of taste; and, in point of practical knowledge, as supposing the soil and climate of Hyde Park to be similar to that of some bleak district in Derbyshire or Scotland. The trees in some of the clumps, though from 5 ft. to 10 ft. in height, are put in at the rate of from 3000 to 4000 plants per acre; and (which, we are sure, will astonish every planter, whether in the north or the south), on the north side of Hyde Park, in a plantation consisting of deciduous trees, many of them 15 ft. in height, made last spring, Scotch pines are planted throughout, not more than 1 ft. in height! We must confess that we do not know anything, in the whole history of planting, on a par with this specimen. What can the Scotch pines possibly be intended for? They cannot be meant for nurses to plants more than ten times higher than themselves, and not more than 5 or 6 feet apart; and Scotch pines can never be intended for undergrowth. Relatively to the trees which are to remain, they, as well as the others which are to be thinned out, can only be regarded as weeds; which not only deprive the other trees of a great part of their nourishment, but exclude from them

a considerable portion of the air and light which are essential to their growth. There never was a plantation less in want of shelter and protection than that to which we allude, east of the Victoria Gate. Independently altogether of the excellence of the soil and climate, it is sheltered on the west by the high trees of Kensington Gardens, and on the north not only by a narrow strip of trees, of from 20 to 30 years' growth, close to it, but by a lofty range of buildings (Hyde Park Gardens) at 200 ft. distance. Shelter, however, is no more required for these trees than if they had been planted in St. Paul's Church-yard; and, as we shall hereafter show, it can only do them harm: indeed, it may be safely asserted, that in no part of the vale of London can any hardy forest tree require artificial shelter, at any period of its growth.

The main object of all these plantations can only be to produce ultimately a few single trees, with the exception of one mass at the Cumberland Gate, which, we have been informed, is intended to direct pedestrians along the newly formed gravel path there, leading across the park. This object, we contend, might have been effected by single trees; or, supposing that this could not have been done, then we contend that the remedy is much worse than the disease. But why should not a few iron hurdles be sufficient for the object in view here, as it is in every gentleman's park, and as it is in Kensington Gardens? Of all the deformities in the way of new plantations put down in the Park, this, in our opinion, is decidedly the greatest. If it is suffered to remain, it will, in three or four years, completely spoil the view on entering the Park by the Cumberland Gate, by destroying all breadth of effect, by shutting out the whole of that fine expanse of turf which constitutes the middle distance, and by completely excluding the Surrey hills and other objects which now form the background. This is a subject that may be readily judged of by any person accustomed to sketch landscape; and those who doubt the validity of our opinion on this point have only to ask that of any landscape-painter.

Supposing that the object of the other plantations is that of producing ultimately a few scattered trees and small groups, we contend that these may be produced much sooner, much more effectually, at much less expense, and with much less deformity in the meantime, by planting them at once where they are finally to remain, instead of surrounding them by other trees in masses or belts. We shall now briefly state our reasons for entertaining this opinion.

*Much sooner.* Having fixed on the situations where the single trees and small groups are to be placed, then, by properly preparing the soil as indicated in Vol. XIII. p. 146. Nos. 3. and 4.; by the choice of trees with stems from 3 in. to 6 in. in diameter, and from 15 ft. to 20 ft. in height, which have been properly prepared before removal; by planting them early in autumn; and by properly protecting them from cattle; we contend that their growth would be more rapid, than that of any tree in a mass with other trees, and they would attain a greater magnitude. The reason is, because an isolated tree, so treated, has access to a much greater supply of nourishment, of water, of light, of air, and of space for the extension of the roots and top, than where it has to share all these requisites for growth and strength with other trees.

*Much more effectually.* A tree which has grown up alone, neither sheltered nor crowded by other trees, adapts its head and its roots to its situation; and, from being in no respect curtailed of nourishment, &c., it acquires not only a greater bulk of head to produce effect in the landscape, but greater strength to resist storms of wind, or excessive cold, heat, or drought. A tree, on the other hand, that is drawn up in a plantation among other trees, though, in many cases, it may exceed in height a tree which has been grown singly, yet it will invariably be found weaker, less bulky in the head, less strong in the stem, less characteristic of its species, and consequently less handsome, and far less able to resist either high winds, or extremes of cold, heat, or drought.

*At much less expense.* This must be sufficiently obvious, because not more

than one tree in a score need be planted; and the fencing of single trees against cattle or deer by any of the modes that we have shown in the article already referred to (Vol. XIII. p. 149. No. 8.\*) is comparatively trifling; while the expense of cleaning the plantation for a number of years, of keeping the boundary fence in repair, and of ultimately thinning out and sowing with grass seeds, is altogether avoided. The expense, however, we consider but a very secondary matter; though it also ought to be subjected to principle.

*Much less deformity in the meantime.* We want words to express our dislike of the lumpish unconnected clumps and masses which have recently been made in the most conspicuous situations in Hyde Park. We will ask any private gentleman whether, if he had such a park, he would tolerate such deformities if perpetrated by his gardener? And, unless the fences and great part of the trees be removed, these deformities will remain at least twenty years. We state this with confidence, because it is nearly, if not quite, thirty years since the belt along the north side of Hyde Park was planted, and it was only thinned out three or four years ago. Will any one assert that, if the single trees now left there, and which formed part of that belt, had been planted by themselves at the time the belt was planted, they would not have been as large as they are at present? We have no hesitation whatever in stating it as our opinion, that they would not only have been larger, but have had far handsomer heads. At no period of their existence can trees planted singly, whether small or large, with or without fences, be considered as deformities in a landscape. Even considered as mere poles stuck in the ground, they harmonise and connect themselves with one another, and with the adjoining objects; and they change their position, and form ever-varying groups, with the varied position of the spectator, who, if he has any imagination, pictures to himself what will be their ultimate appearance. To be convinced of the truth of this position, we have only to look at the single trees planted two or three years ago, and fenced with thorns, in the Regent's Park.

If, notwithstanding what we have stated, it should be contended that, in the vale of Middlesex, single trees, of a given size, and a given power of resistance to the weather, will be sooner produced by planting them in masses than by planting them singly, then we can only recommend the opinion to be taken of gardeners and planters, who are at once scientific men, and men who have had extensive practice in this department. We state this, because we certainly think that the public have no right to have such deformities inflicted on them as have recently been perpetrated in Hyde Park, unless it can be shown that they are necessary for the end in view.

---

ART. VIII. *Botanical, Floricultural, and Arboricultural Notices of the Kinds of Plants newly introduced into British Gardens and Plantations, or which have been originated in them; together with additional Information respecting Plants (whether old or new) already in Cultivation: the whole intended to serve as a perpetual Supplement to the "Encyclopædia of Plants," the "Hortus Britannicus," the "Hortus Lignosus," and the "Arboretum et Fruticetum Britannicum."*

*Curtis's Botanical Magazine*; in monthly numbers, each containing seven plates; 3s. 6d. coloured, 3s. plain. Edited by Sir William Jackson Hooker, LL.D., &c.

*Edwards's Botanical Register*; in monthly numbers, new series, each containing six plates; 3s. 6d. coloured, 3s. plain. Edited by Dr. Lindley, Professor of Botany in the London University.

---

\* See the subject of Tree Guards treated in detail, and illustrated by twelve engravings, in the *Suburban Gardener*, p. 555.

*Maund's Botanic Garden, or Magazine of Hardy Flower Plants cultivated in Great Britain*; in monthly numbers, each containing four coloured figures in one page; large paper 1s. 6d., small 1s. Edited by B. Maund, Esq., F.L.S.

*Paxton's Magazine of Botany, and Register of Flowering Plants*; in monthly numbers; large 8vo; 2s. 6d. each.

*The Floral Cabinet*; in monthly numbers, 4to; 2s. 6d. each. Conducted by G. B. Knowles, Esq., M.R.C.S., F.L.S., &c. and Frederick Westcott, Esq., Honorary Secretaries of the Birmingham Botanical and Horticultural Society.

*The Botanist*; in monthly numbers, each containing four plates, with two pages of letterpress; 8vo; large paper, 2s. 6d.; small paper, 1s. 6d. Conducted by B. Maund, Esq., F.L.S., assisted by the Rev. J. S. Henslow, M.A., F.L.S., &c., Professor of Botany in the University of Cambridge.


*Lindley's Sertum Orchidaceum, &c.*; in parts, folio, 1l. 5s. each. Parts III. and IV.

### GERANIA<sup>^</sup>CEÆ.

1932. GERA<sup>^</sup>NIUM 17217 tuberòsum var. ramòsum *Lindl.*; Bot. reg. 1839. t. 10.

This is a variety of the *Geranium tuberòsum*, which was collected by the Hon. W. Fox Strangways, near Potenza, in the kingdom of Naples; and which differs from the species in "branching from its very base. This is supposed to be the first geranium described by Dioscorides, the root of which, that author states, is sweet and eatable." (*Bot. Reg.*, Feb.)

#### *Leguminòsæ.*

1246. CHORO<sup>^</sup>ZEMA [106  
\*Dicksòni R. G. Mr. Dickson's  pr 3 my.s S. Y. Swan River 1836. C sp.1 *Botanist*,

This plant has larger flowers than most other species of the genus. It "was raised by Messrs. James Dickson and Sons of Edinburgh," from seeds imported from the Swan River. (*Botanist*, Feb.)

2136. LA<sup>^</sup>THYRUS [vol. ii. p. 177  
\*purpùreò-carùleus *Kn. et West.* purplish blue. R pr 10 au.s P.B. Brazil ? 1836. C l.p. *Flor. cab.*

A pretty hardy suffruticose pea; raised in the Birmingham Botanic Garden, from seeds received from Brazil. (*Flor. Cab.*, Feb.)

#### *Compòsitæ.*

2340 CINERA<sup>^</sup>RIA 21446 cruénta.  
*Synonyme*: Senècio cruénta *Bot. Reg.* 1839, t. 7.

#### *Campanulàcæ.*

611. PHYTEU<sup>^</sup>MA 5166 Hálleri *Bot. Gard.* 680.

#### *Ericàcæ.*


1173. ERI<sup>^</sup>CA 9572 tricolor var. supérba *Paxt.*

A variety with large pink flowers, raised from seed sown by Messrs. Rollisson of Tooting, about five years since, which flowered, for the first time, in 1836. (*Paxt. Mag. of Bot.*, Feb.)

#### *Boraginàcæ.*

443 NO<sup>^</sup>NEA 30339 flavéscens *Bot. Gard.* 678.

#### *Labiàtæ.*

76. SA<sup>^</sup>L<sup>^</sup>VIA [p. 2  
\*pàtens *Benth.* spreading  or 10 au.o D.B. Mexico 1838. C 1 *Paxt. mag. of bot. vol. iv.*

Seeds of this splendid plant were received early in 1838, from Real del Monte in Mexico, by Messrs. Lowe and Co. of Clapton. The seeds vegetated early in spring; and, being planted out in June, produced their splendid, large, dark blue flowers in the following August. The plants were afterwards re-

moved to the green-house, where they have flowered abundantly. This species has been propagated by cuttings, which root readily; and promises to stand out in the open border, with a very slight protection to the roots. (*Part. Mag. of Bot.*, Feb.)

*Plumbaginaceæ.*

929. *STATICE* 29286 arborea *Bot. Reg.* 1839, t. 6.

*Orchidaceæ.*

2537. *MAXILLARIA*

\**tenuifolia* Lindl. slender-leaved  $\text{£} \square$  pr 1 my.jn R.Y Vera Cruz 1837. D w [1839, t. 8 Bot. reg

This "species inhabits trees in Mexico, and is probably local, as it does not appear in any of the collections brought from the interior of the country." It was found near Vera Cruz by M. Hartweg. It thrives best "in a warm damp stove, with a block of wood thrust into the soil, and the long branching rhizoma tied to it. It grows almost equally well when tied to a wooden block, and suspended." It requires water to its roots, and to be syringed over head; and it is very easily multiplied, "as it throws out numerous pseudo-bulbs and roots, which, if taken off, and subjected to the above treatment, will soon become vigorous-growing plants." (*Bot. Reg.*, Feb.)

+ *Oberonia recurva* Lindl. A curious little plant, with "a pendulous raceme, scarcely more than 1 in. long, consisting of minute densely imbricated flowers." It is a native of Bombay, and is nearly allied to *O. Wightiana*, "an unpublished species from Madras." (*B. M. R.*, No. 8., Feb.) For some particulars respecting the genus *Oberonia*, see the *Sert. Orch.*, as quoted in our vol. xiv. p. 288.

+ *Megaclinium oxypetrum* Lindl. A fine species, a native of Sierra Leone. (*B. M. R.*, No. 10., Feb.)

+ *Pleurothallis bicarinata* Lindl. "The flowers are of a dull greenish yellow. The leaf is 5 in. long, and the petiole 6 in. A native of Brazil." The three last-named plants have been imported by Messrs. Loddiges. (*B. M. R.*, No. 11., Feb.)

+ *Epidendrum (Hormidium) uniflorum* Lindl. "A Mexican plant of no beauty, with yellowish green flowers." Under this head, Dr. Lindley gives some observations on the genus *Epidendrum*, which, he thinks, cannot be divided. For this reason, he has suppressed the genera *Auliza Salis.*, the type of which is *E. ciliare*, *Amphiglotis Salis.*, and *Encyclia Hook.*; and he thinks that the *Prosthècia* or *Epithècia* of Knowles and Westcott will not stand. Dr. Lindley, however, thinks that the present plant may form the type of a new genus, which he has named *Hormidium*. (*B. M. R.*, No. 13. Feb.)

+ *Brasavola grandiflora* Lindl. This is a native of Honduras, the finest species of the genus, and only the flowers have been yet received. "It resembles a gigantic specimen of *B. nodosa*." (*B. M. R.*, No. 14., Feb.)

*Ponera graminifolia* Lindl., syn. *Nemaconia graminifolia Knowles & Westcott*. This was supposed to be a new genus; but Dr. Lindley, having carefully examined the plant in question, is convinced that it is of the same genus as *Ponera juncifolia*, described in the *Gen. et Spec. of Orchid. Plants*, p. 113. (*B. M. R.*, No. 15., Feb.)

+ *Arpophyllum spicatum* La Llave. "One of the most graceful and beautiful of the Mexican *Orchidaceæ*; it has recently reached England in a living state." It was found growing on trees, and is very rare even in its native country. Its flowers are pink or pale purple, and are disposed in a dense spike. The genus is very near *Ponera*. (*B. M. R.*, No. 16., Feb.)

3411a. *STANHOPEA*

*Wardii* Lodd. in litt. Mr. Ward's  $\text{£} \square$  or 1 j.lo Y.Br Mexico 1836. D p.r.w [20., and Fl. Cab. ii. Sert. Orch.

This truly splendid species "was sent to England, from La Guayra, by Mr. Ward, to Messrs. Loddiges, by whom it was named. "It differs from *S. quadricornis*, in the lower part of the lip not having a strong horn on each side; and from *S. oculata*, in the lip being sessile, not stipulate, and a great deal shorter in proportion to the other parts." (*Sert. Orchid.*, part iv.)

\*SCHOMBURGKIA

*marginata* Lindl. bordered £ [ ] or 4 au.s R.Y Surinam 1834. D. trees Sert. Orch. 13

This very elegant plant was figured by Dr. Lindley, from dried specimens, and a drawing from Surinam; but it has since flowered in England, in the collection of Thomas Brocklehurst, Esq., of the Fence, near Macclesfield. "This epiphyte grows abundantly near the town of Paramaribo, in Surinam, in an avenue of very fine trees of a species of *Erythrina*," which grows 60 or 80 feet high, and has a very rough bark. The epiphyte is generally found in the first fork of this tree; which, from its being commonly placed in the coffee plantations, as a nurse to the young trees, has received from the inhabitants the popular name of Coffee Mamma. The Schomburgkia will "not flower in a pot filled with dead wood and mould," but succeeds perfectly well either on a living tree or on a rotten branch. In its native state, its flower stalk is frequently 4 ft. high, branching, and covered with flowers. During the dry season, it will bear intense heat without injury. (*Sert. Orchid.*, part iii.)

3573. 2530a. CYCNOCHES

[Orch. 16

*chlorochilon* Klotzsch ?green-lipped £ [ ] or 2 in.jl G Demerara 1838. D p.r.w. Sert

"This noble species" was introduced from Demerara by Messrs. Loddiges; but it had been before "sent to Berlin, in 1836, from Maracaybo, by M. Moritz," and described by Dr. Klotzsch. It differs from *Cycnoches ventricosum*, "in the flowers being much longer, the raceme shorter and less graceful, the sepals and petals broader and not so acute; and especially in the form of the lip, which is nearly sessile, obovate, and acute, not ovate and acuminate, green, not white, with the broad green callosity at the base far larger, and differently formed. The flowers are from 5 in. to 8 in. in diameter, and are deliciously fragrant." (*Sert. Orch.*, part iv.)

2547. DENDROBIUM

[18

*carulescens* Wall. bluish £ [ ] or 2 ap. B.P Khosea 1837. D trunks of trees Sert. Orch.

This species, in foliage and general appearance, resembles *D. nobile*, but the flowers are very different. "The sepals and petals have a delicate tinge of very pale bluish lilac, especially on the back, and their form is more slender and graceful." The sepals are tinged with deep purple at their tips, and slightly pitted over, so as to have a tessellated appearance. The petals are coloured like the sepals, but rather darker. This species was discovered by Mr. Gibson on the Khosea Hills, at an elevation of 4000 ft.; growing on rocks and the trunks of trees, with thirty or forty flowers on a stem. It flowered at Chatsworth in April, 1838. (*Sert. Orch.*, part iv.)

2545. ONCIDIUM

[3705

\**Forbesii* Hook. Mr. Forbes's £ [ ] or 1 o S.Y Organ Mountains 1837. D p.r.w Bot. mag.

"A very rare inhabitant of the Organ Mountains, discovered by Mr. Gardner in 1837." It blossomed at Woburn Abbey, in October, 1838; and Sir W. J. Hooker has named it in honour of Mr. Forbes; "by whose judicious care so many rarities, both of Mr. Gardner and of other collectors, have been brought to a high degree of perfection." The species is nearly allied to *O. crispum*, but it differs in the colour of the flowers, and the size of the panicle. (*Bot. Mag.*, Feb.)

2555. POLYSTACHYA

[Bot. mag. 3707

*grandiflora* Lindl. MSS. large-flowered £ [ ] cu ½ o G.P Sierra Leone 1837. D p.r.w

A native of Sierra Leone, which flowered in the stove of John Allcard, Esq., of Stafford Green, near London, in October, 1838. Sir W. J. Hooker had placed this plant in the genus *Maxillaria*, till he was informed by Dr. Lindley that it belonged to *Polystachya*. (*Bot. Mag.*, Feb.)

3597. 2530a. MONACHANTHUS

[mag. 3708

*fimbriatus* Gardner MSS. fringed £ [ ] cu 1 n | G.W Pernambuco 1837. D p.r.w. Bot.

A curious-looking plant, with a yellowish green flower, the hood-like labelum being fringed with white. It agrees, "in general habit, and in its mode of inflorescence," with *M. viridis*; but it differs from that species "in its slender and more tapering pseudo-bulbs, and the many-flowered scape; and, still more remarkably, in its three-lobed fringe and labelum, and the excavated

column." It was found growing under the shade of some low shrubs, on a dry sandy bank. (*Bot. Mag.*, Feb.)

2565. *AE'RIDES*

affine *Wallich* related  $\text{£} \square$  or 1 au Pk [Nepal 1838. D. p.r.w Sert. orch. 15  
*Synonyme* : *A. multiflorum Roxb.*

This is one of the very finest of the East Indian *Orchidaceæ*; but, unfortunately, its flowers have no fragrance. The flowers are of a deep rose colour, spotted with purple, and form a cylindrical raceme about 9 in. long. The plant was first discovered by Dr. Roxburgh in Sylhet; but Dr. Wallich found it on the mountains of Nepal, near Shecopore. The plant has flowered in the collection of Messrs. Loddiges. (*Sert. Orch.*, part iii.)

\**SOPHRONITIS Lindl.*

*grandiflora Lindl.* large-ld.  $\text{£} \square$  or  $\frac{1}{2}$  ... S Organ Mountains 1837. D p.r.w Bct. mag. 3709  
*Synonyme* : *Cattleya coccinea Lindl.* in text of *Bot. reg.* t. 1919.

This beautiful little plant was figured by Dr. Lindley, in part i. of his *Sertum Orchidaceum*, t. 5. f. 2.; and we gave a quotation from his description of it in our review of that work, Vol. XIV. p. 150. The plant has since been introduced by Mr. Gardner, who found it on the Organ Mountains, and sent it home in 1837. (*Bot. Mag.*, Feb.)

*Iridaceæ.*\**PHALOCA'LLIS Hook.* plúmbea *Lindl.* lead-coloured; *Bot. mag.* 3710.

*Synonyme* : *Cypella plúmbea Lindl.*; *Bot. reg.* 1838, t. 24.

We have already mentioned this plant in our *Floricultural Notices*, Vol. XIV. p. 485., as having been included by Dr. Lindley in his *Miscellany*. It has since flowered at Spofforth, from a bulb received from M. Otto of Berlin, and is figured in the *Bot. Mag.* for February. "This very remarkable plant," says Sir W. J. Hooker, "though its flower is delicate and beautiful, disappoints the expectation, by producing, as far as I have seen, on its strong and tall stem, only one blossom, which expands before sunrise, even in a dark room, and passes away ere noon." (*Bot. Mag.*, Feb.)

*Amryllidaceæ.*

+ *Cyphonëma Loddigesianum Hook.* This, Sir W. J. Hooker observes, is "a remarkable new genus, of which a live specimen in flower has been sent to Spofforth by Mr. Loddiges, as he states, from Valparaiso; being the first cyranthiform plant found elsewhere than in South Africa." In a note, it is added that Mr. Loddiges had other bulbs in the house at the same time that he received the Chilian bulbs; so that it is possible there may be some mistake as to the native country of the *Cyphonëma*.

## ART. IX. *A Selection of standard Pears and Apples suitable for small Gardens in the Climates of London, Edinburgh, and Dublin.*

By ROBERT THOMPSON, of the Fruit and Kitchen-Garden Departments in the London Horticultural Society's Garden.

BEING frequently asked for a list of the smallest number of kinds of apple and pear trees, which, grown as standards, will supply these useful fruits throughout the year, we have generally referred to the lists contained in our Vol. XI. p. 34—38.; but, as many of our present readers may not possess that volume, and, besides, as we wish to confine the selection to apples and pears, and these of as few kinds as possible, we again applied to Mr. Thompson, who kindly sent us what follows. We beg the particular attention of our readers to Mr. Thompson's remarks, which on this, as on every occasion, are most valuable.

### *List of Pears adapted for Standards in the Climate of London.*

- |    |                      |   |   |   |                 |
|----|----------------------|---|---|---|-----------------|
| 1. | { Citron des Carmes  | - | - | - | ripens in July. |
|    | { Summer St. Germain | - | - | - | — August.       |



2.	{	Fondante d'Automne	-	-	-	ripen in Sept. and Oct.
	{	Louise-Bonne (of Jersey)	-	-	-	October.
3.	{	Marie Louise	-	-	-	November.
	{	Beurré Bosc	-	-	-	November.
4.	{	Beurré Diel, or the Althorp Crassane	-	-	-	November.
	{	Glout Morceau	-	-	-	Nov. and Jan.
5.	{	Winter Nelis	-	-	-	Nov. and Jan.
	{	Passe-Colmar	-	-	-	Nov. and Jan.
6.	{	Easter Beurré	-	-	-	Jan. and March.
	{	Beurré de Ranz (improperly, Rance)	-	-	-	March and May.

Should circumstances render it necessary to limit the number of trees to six, the above may be grafted as denoted by the brackets; in placing which, regard was had to the growth of the tree. For example, it would be improper to work the Beurré Diel, a rambling broad-leaved sort, with the Winter Nelis, which has slender wood and narrow leaves, assimilating to those of the Passe-Colmar, with the growth of which it will very nearly correspond.

The fruit of the Beurré de Ranz (not Rance), by being deposited in a cool dry situation, may be kept for a month longer than the period above mentioned. The very early summer varieties of apples and pears will only keep a few days; it would therefore be more advantageous to graft only one limb, composing the fourth or sixth part of a tree, of each kind; and, by so doing, the Ambrosia and Summer Franc réal might be introduced. In short, it would be desirable to limit the autumn varieties to as few trees as possible, in order to leave space for whole trees of the more valuable late ones.

*Edinburgh and Dublin.* — The preceding selection will probably be found to succeed as dwarfs, in sheltered situations, at Edinburgh and Dublin. If a *sloping* bed of *concrete* could be afforded for the roots, great advantages would accrue, with regard to both flavour and bearing; or a bottoming of small stones would likewise prove beneficial, and such can frequently be easily procured. The bottoming, whether of concrete or other materials, is recommended to be laid sloping, for the following reasons. The roots of pear and apple trees have a tendency to strike downwards perpendicularly, at least a considerable portion of them; and they will find their way through the loose materials, till they reach the evil which these materials were intended to guard them from, the cold subsoil; but, when a slope is offered, they will be more easily induced to follow it, and that in proportion as it approaches the direction of their natural tendency. In the case of concrete, of course the roots cannot penetrate it, but it is nevertheless advisable to give it a slope, otherwise water would rest stagnant, and probably acquire acidity from solutions derived from the soil above, and hence disease may ensue. It is scarcely necessary to remark, that perfect drainage should be effected exterior to, and lower than, the surface of the concrete, or the *bottom* of the stratum of stones.

For Edinburgh, as well as Dublin, it will probably be found proper to substitute the Althorp Crassane for the Beurré Diel, and Hacon's incomparable for the Passe-Colmar; the Ne plus Meuris should also be kept in view, in case the Glout morceau or Easter beurré should not succeed.

On reconsidering the above limited selection, it has been thought advisable to mention a few other sorts, in order that those who choose may possess a greater variety, even although they had not space to increase the number of trees. It is necessary to observe, that, where a branch is to be grafted, it should be cut off in winter, at, or a little above, the place where the graft is intended to be inserted; otherwise, if delayed till spring, when the sap is flowing, the alburnum is often killed to the next branch below, or to some latent bud, so that the graft sometimes does not take, more especially if the branch be large; or, if it does form a union, canker generally takes place. If this remark be attended to, and if the operation be judiciously performed, no injury whatever will result. The vigour of the following sorts, of which the flavour is likewise excellent, will correspond sufficiently near with that of the above, which are included by the brackets 1, 2, and 3. : —

Aston Town - ripens in Oct., Nov.	Urbaniste - ripens in Oct.
Comte de Lamy — Oct.	Burgermeester — Nov.

*Selection of Apples for the Climate of London. — Dessert Sorts.*

{ Early red Margaret - - -	- ripens in August.
{ Devonshire Quarrenden - - -	- — Aug. and Sept.
{ Oslin - - - - -	- — Aug. and Sept.
{ Summer golden Pippin - - -	- — Aug. and Sept.
{ Kerry Pippin - - - - -	- — Sept. and Oct.
{ Wormsley Pippin - - - - -	- — Sept. and Oct.
{ King of the Pippins - - - - -	- — Oct. and Jan.
{ Hughes's golden Pippin - - -	- — Dec. and Feb.
{ Pearson's plate - - - - -	- — Dec. and March.
{ Ribston Pippin - - - - -	- — Nov. and March.
Downton Nonpareil - - - - -	- — Dec., April, or May

*Edinburgh and Dublin.* — In situations where the Ribston pippin is known to canker, the Herefordshire pearmain may be substituted; and, with this alteration, the above selection is presumed to be suitable for the climates of Edinburgh and Dublin. For additional choice and trial, the following are highly deserving of notice, as dessert apples of approved excellence: —

Large Yellow Bough, or Early Harvest -	ripens in the beginning of August.
Golden Reinette - - - - -	— Oct. and Jan.
Golden Harvey - - - - -	— Dec. and May.
Scarlet Nonpareil - - - - -	— Jan. and March.
Braddick's Nonpareil - - - - -	— Jan. and April.
Old Nonpareil - - - - -	— Jan. and May.

*List of Kitchen Apples suited for the general Climate of Britain.*

From the following sorts of kitchen apples, suitable for the general climate of Britain, a supply may be obtained throughout the year: —

Hawthornden	Alfreton
Blenheim Pippin	Brabant Bellefleur
Bedfordshire Foundling	Northern Greening

In compliance with your request, I have done the best I could, with regard to a limited selection for the three capitals; but I regret that no national or cooperative means have been adopted, for enabling us to speak, with more certainty, as to the success of particular kinds of fruits, in parts of the kingdom remote from London. I have added some remarks, which you may follow up and enforce, if you please, with others to the same intent, that of improvement in cultivation by attention to the situation of the roots. Scotland has natural slopes in abundance, and also many sheltered spots; improvement has not yet reached its utmost limit, as might be easily proven. After what has been done, the idea is not too paradisaical, to picture Britain generally, interspersed with small groups of orchard trees, such as you would wish to recommend, in full bearing, as if vying with certain portions of Asia Minor. What, it may be asked, are the difficulties to be overcome, the advantages to be taken, and the disadvantages to be combated? Resolved simply in this: the advantages are, a long summer day, with, frequently, uninterrupted bright sunshine, sufficient to ripen wheat as far north as Morayshire; and I believe that where wheat can be brought to perfection, so may be properly selected varieties of the apple and pear. But, whilst such atmospheric advantages prevail, they are, in most situations, *counteracted* by the natural coldness of the subsoil; and here is the main scope for art to interfere. In short, the roots must be isolated, as it were, from their cold bed, and kept within the influence of the sun. Lay aside the subject of rich and deep borders, till it can be ascertained what means are the most effective towards the at-

tainment of the object above mentioned; for, except, perhaps, with regard to kitchen apples, it is better to have a large quantity of saccharine matter in small compass, than a large acid development, occasioned by a rich but cold soil. In former times, the monks placed slates below their fruit trees, but some more effectual interposition is necessary. If pears, for instance, be found to ripen so as to have a rich flavour in some soils, and only indifferently in others, all other circumstances being similar, let the nature of both soils be ascertained, as well as that of the substrata, and the difference noted. A soil moderately rich, and adapted for imbibing the rays of the sun to a considerable depth, is undoubtedly the best. Means may be inadvertently employed to dissipate this genial heat, and frequently are so; what progress may be made with regard to an opposite mode of proceeding, and the consequent results, time must determine.

---

ART. X. *Some Remarks on the Ripening of Pears, in the Years 1837, 1838, and 1839.* By T. RIVERS, Jun.

*BEURRE DE RANZ* (not Rance, as it is commonly called) proves to be one of the hardiest of the Belgian varieties, and bears most abundantly as a standard; but this present season, quite contrary to my calculations, as I feared the fruit would not ripen owing to the cold and wet summer, these pears have come into use two or three months before their usual period, and are now, at this present time, January 20th, quite ripe, and in fine perfection; being more juicy and higher-flavoured than I ever tasted them. They were gathered from young standard trees, growing in a warm sandy loam, subsoil pure sand. The fruit from the same trees, last year, 1837, were not fit for the table till June, 1838, and some of them were preserved without difficulty till July.

*Hacon's Incomparable*, or, more properly, the Downham Seedling, (as Mr. Hacon had no more to do with raising it from seed, than the baker in whose yard the original tree grows, planted by no one knows whom, or when,) may, most certainly, be called one of the finest pears known. The fruit ripened this season very early in December, scarcely keeping till Christmas, from young standard trees. In ordinary seasons, this fine pear is fit for the table during the whole of December and January. No fruit can be more delicious, from standards. The fruit is as long and handsome as full-sized Crassane pears from walls; and most like them in shape and colour. The tree is pendulous, and very hardy and prolific.

*Bon Chrétien Fondant*, as in last season, has proved soft, dry, and worthless, ripening early in November. This sort is an early bloomer, and liable to be cut off by spring frosts.

*The Aston Town Pear* proves to be a most excellent variety; juicy, melting, and high-flavoured. Fruit from standards was in perfection this year till the end of November. This is a very hardy and prolific variety.

*Comte de Launy* is also a most excellent pear, remarkably full of a sugary refreshing juice. This is a very hardy sort, withstanding the sharp frosts of last spring as well or better than most varieties.

*The Easter Beurré* has now failed three years successively, owing to the frosty springs and its habit of blooming very early. This is the most precocious, and the most abundant-flowering pear known; but not by any means a plentiful bearer. This season fruit from young standards appear as if they would keep till March; other seasons, I have known them quite ripe in the beginning of December.

*Beurré Diel*, in spite of the last unpropitious summer, ripened well from standards; and, as usual, the fruit were fit for the table all December. For those who like a musky perfumed pear, this is good; it has proved more hardy than the Easter beurré, having borne well these two bygone seasons.

*Beurré Bosc* is not an abundant bearer while the tree is young; but a highly flavoured and delicious pear. Last season it was fit for the table, in the beginning of November; this season it retained its flavour and juice till the end.

*Louise-Bonne of Jersey* is also a November pear. My notes for November, 1837, say, "juicy and medium-flavoured;" but this season, I gave it unqualified praise, as the few fruit my trees produced were quite delicious. This variety blooms too early for cold springs.

*Glout Morceau* may be called a Christmas pear. These two last seasons, I suspect, owing to the want of sun, and our usual atmospheric warmth, not more than half of the produce of my numerous standards have had flavour. I reckon this pear inclined to be tame and insipid. It forms a robust and handsome tree, even in the most cold and clayey soils.\*

*The Beurré de Capiaumont* may be called the "Hawthorden" (alluding to the well known prolific nature of the apple of that name) of pears. It bears abundantly everywhere, at all ages, and under any circumstances; and, for October, is a very handsome and very delicious pear. For a "Cockney garden" it is invaluable, bearing well in pots.

*Thompson's Pear*, for an autumnal pear, is quite worthy of cultivation. This season, these pears were remarkably juicy and high-flavoured, and fit for the table the whole of November. Like most of the new pears, this is hardy; the trees, even in the coldest soil, growing freely, without canker.

*The Winter Nelis*, *Bonne de Malines*, or *Nelis d'Hiver*, like *Hacon's* incomparable, ought to be planted by every owner of a garden. It bears well as a standard, though the fruit is rather small; but nothing can be more delicious than this desirable pear, during the whole of January.

*The Althorp Crassane* approaches the last very nearly in excellence, but seems variable in its time of ripening. Last season they kept well till the end of January; this season they were quite ripe early in December. The tree is inclined to be thorny, but it is remarkably hardy and bears well.

*The Winter Crassane* is, perhaps, one of the hardiest and most prolific pears known; but it is not of first-rate excellence. Still, as it keeps well till February, though not very juicy or high-flavoured, it ought to be planted; more particularly in soils and situations unfavourable to the finer varieties.

It may be proper to remark, that, as the period of ripening and quality of the Flemish, and new pears in general, vary so much in different soils, situations, and seasons, it will be interesting to hear from different correspondents their opinions; always stating the soil, and the situation of the trees. The trees on which my fruit grew are in a sandy loam, and the subsoil generally is a siliceous sand.—*Sawbridgeworth Nursery, January 20. 1839.*

#### ART. XI. *On the Cultivation of Màdia sativa, as an Oil Plant.*

By W. HERTZ, Nurseryman and Seedsman, Stuttgart.

M. BOSCH, superintendent of the gardens of the king of Wirtemberg, has made numerous experiments for many years on acclimatising exotic plants,

\* A standard tree of this variety, which we have at Bayswater, and of which there is a portrait in the *Arb. Brit.*, has borne freely every year since it was planted, in 1824. The fruit has been invariably high-flavoured; it is in perfection now (Feb. 10.), and as delicious as in any preceding season. The soil is a loam on gravel; the situation open, but surrounded by suburban houses. It is a characteristic of the pear, however, as Van Mons has observed, to grow better in and about towns, than any other fruit tree, except, perhaps, the fig and the mulberry. Since the above was written, we understand that Mr. Masters of Canterbury has two varieties of the *Glout morceau*; one, which seems to be identical with the kind of which we have a tree, he calls *Glout morceau de Cambron*. — *Cond.*

during the course of which one plant, *Màdia sativa*, attracted peculiar attention, as he found from the reports of travellers in Chile, that it is cultivated in that country as an oleiferous plant, and an excellent oil is extracted from it. During the last few years, M. Bosch has given this plant a fair trial on a large scale, at considerable expense; and the results of this trial have surpassed his most sanguine expectations.

The plant is an annual belonging to the natural order *Compósitæ*, attaining the height of from  $1\frac{1}{2}$  ft. to 2 ft.; it agrees with every rotation of crops, and succeeds in all soils, provided they are neither too humid nor too stiff and binding; but, in a rich soil, if the necessary space be given to the plant to spread out its branches, it attains the highest perfection. The proper season for sowing is either in October, or the spring, and the necessary quantity of seeds required for an acre depends upon the condition of the soil, and varies from 4 lb. to 6 lb.; but it is, of course, advisable to sow a little more than is actually wanted, to provide against any unforeseen accidents which may happen to the seeds before germination. The young plants are not damaged by spring frosts; nor are they liable to be attacked by animals or insects. If spring sowing be preferred, the ground must be well prepared in the autumn, in order to sow the seeds as early in the spring as possible; after which they must be pressed down by rolling, and will need no other culture than to be kept free from weeds. When the seeds begin to ripen, which may be easily known by the change of their colour from green to black, the plants are either cut off near the ground, or pulled up by the roots, and laid on the ground for drying; after which they are treated like rape. The seeds, however, must not remain long before they are threshed out; because the glutinous stalks, when heaped up, soon begin to ferment, and will do the greatest damage to the seeds.

The produce of one Wirtemberg acre containing 38,400 square feet amounts, according to the nature of the soil, and the condition of the plants, to from 4 to  $6\frac{1}{2}$  scheffel (bushels) of seed. One scheffel weighs from 194 lb. to 208 lb.; and from that quantity from 68 lb. to 70 lb. of oil have been obtained, according to the trials that were made in several mills of different constructions.

According to a chemical analysis, 100 parts of the *Màdia* oil consist of 45 parts of oleine (or fluid part of the oil), 40 of stearine (the mucilage, or fatty part), and 15 of glycerine (or sweet solid part, a honey-like and glutinous substance). This oil does not congeal at  $19^{\circ}$  below Reaumur, but only becomes a little less fluid, which makes it an incomparable substance for keeping all sorts of machines in order; and there can likewise be a solid and well lathering soap made of it. That it may be advantageously used in cloth manufactories has been proved by experiments already made, by which it was found preferable to the olive oil, which had been previously used. The produce of this annual oil-plant, if compared with that of the rape and the poppy, leads to the following conclusions:—

The rape, which attains its perfection only in the second year, produces from 4 to 5 scheffel of seed per acre, and but seldom succeeds well. One scheffel of rapeseed gives 96 lb. of oil; therefore, one acre, in the space of two years, produces 480 lb. of oil, which makes for one year 240 lb.

One acre sown with poppies gives from  $2\frac{1}{4}$  to 3 scheffel of seed; from one of which are obtained 88 lb. of oil, which gives a produce of 264 lb. per acre yearly.

One acre cultivated with *Màdia sativa*, which ripens generally towards the end of July, produces from 4 to  $6\frac{1}{2}$  scheffel of seed. One scheffel gives 68 lb. of oil, therefore  $6\frac{1}{2}$  scheffel make a produce of 442 lb. of oil.

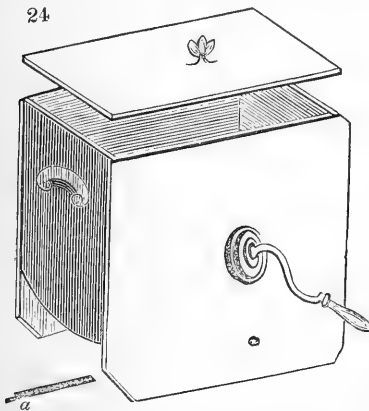
For all these reasons, it is to be hoped that the *Màdia sativa* will soon take that place in our agriculture, to which, by its usefulness, it is justly entitled; and which, also, our sovereign (the king of Wirtemberg) has already acknowledged, by rewarding with a gold medal the merit of M. Bosch, in introducing a plant into field culture which promises to become uncommonly useful, not only to our agriculture, but to our manufactures and trades. To

make this important article as general as possible, I have a quantity of its seed for sale; and, for the convenience of the English agriculturists, I have made an offer to Mr. Charlwood to undertake the sale of it in England.—*Stuttgart, Dec. 30. 1838.*

## MISCELLANEOUS INTELLIGENCE.

### ART. I. *General Notices.*

*A STONEWARE Churn*, of which *fig. 24.* is a perspective view, has lately been invented, or brought into notice, by Mr. Daniel Chambers, of Carey Street,



London. In form, and in the manner of using, it is in every respect the same as the patent box-churn figured in page 1040. of the second edition of our *Encyclopædia of Agriculture*; but the great advantage of the present invention is, that being made of earthenware it is much easier kept clean and sweet than when made of wood. The size of that of which we have given a figure, is the smallest that is made; and it will churn so small a quantity as half a pound of butter at a time. As this churn from being made of earthenware is rather too heavy for being lifted up and emptied, there is a small hole on one side near the bottom (indicated in the figure), to let off the butter-milk; which hole is easily stopped with a common cork. The lid has a

rebate, as shown at *a* in the figure, for the purpose of preventing the milk from splashing over during the operation of churning.

We have much pleasure in noticing this invention, because it will not only greatly contribute to cleanliness, and to the sweetness of the butter produced, but also to lessening the labour of the dairymaid in scalding and scouring. In Germany, there are small churns of the common plunge kind, made of china-ware, in which a small quantity of butter may be churned; but the labour in churning with a plunge churn is much more disagreeable than that of churning with the patent churn, whether formed of earthenware or wood.—*Cond.*

### ART. II. *Foreign Notices.*

#### NORTH AMERICA.

*PHILADELPHIA, Nov. 4. 1838.*—You will receive with this a root and some seed of the *Kühnia eupatorioides*, a very scarce plant in this vicinity. I have only seen a few in a location about two miles above the city, on the immediate north bank of the river Schuylkill. The plants that I obtained the seed from, I grew in pots, and they flowered well. This is the first time I have seen the flower. Dr. Torrey says the flowers are white; with me they were cream-coloured, which appears to be the difference between them and the eupatoriums. It would make a good border plant, though rather coarse, yet of some consequence to a botanical collection from its scarceness. It grows on a dry gravel, which has very little soil amongst it.

The Horticultural Society here is progressing rapidly. An efficiency has been given to it, which it never before possessed, since the election of Horace Binney, Esq., to the presidency, a gentleman of fine cultivated talent and high forensic attainments, which have placed him at the head of his profession, so that few or none are superior to him in the country. Since the report of last year's exhibition, we have had an accession of two amateurs and two practical men, in erecting stoves and green-houses in this city. Dr. Wood, professor of materia medica in the Pennsylvania University, is making a collection of tropical medical plants, as well as native, which will be of great advantage to the student. His houses are fast filling up; besides, he has some fine camellias, lemons, orange trees, &c. The other amateur, General Robert Patterson, has a noble range of green-houses filled with many fine exotics, especially the orange and lemon trees, he having purchased many of the trees of the late Henry Pratt, Esq., of Lemon Hill, who had the best collection in this country, or, perhaps, in any other. The practical men are Messrs. McKenzie and Buchanan, who have put up some fine houses. They are very industrious, and deserve the confidence of the public, from their strict integrity and attention to business. Their collection of exotics is fine, and increasing fast.

On visiting John B. Smith, Esq., I had a fine treat in seeing so many tropical plants in flower; they have all been raised from seed since 1836, he having sold off all his former collection; viz. the *Clusia álba*, *Moringa pterygospérma*, *Brugmànsia prolífera* vel *Weymània*, *Camerària latifolia*, *Lawsonia inérmis*, *Bréxia integrifolia* and *B. serratifolia*, *Asclèpias gigantèa*, *Hura crépitans*, *Cérbera Thevétia*, *Jacquínia ruscifolia*, and some plants of *Cárica Papàya* in fruit, which are about 8 ft. high, with stems from 6 in. to 8 in. in circumference. They have been in fine fruit all summer. I saw, besides, ten different kinds of *Dracæna*, five *Zamias*, and one of them unnamed, a very large plant of the *Latània borbónica*, and a *Córypha umbraculífera*, *Elæis guineénsis*, *Thrinax parviflora*, *Còcos aculeàta*, *Arèca montàna*, *Caryòta ùrens*, *Anacárdium occidentàle*, and a great many plants of *Adansònia digitàta*. In one of your late Numbers, you mention the *Brugmànsia Weymània* as something new. It may be so to you, but it has been here in flower since 1830, and Mr. Smith called it *B. prolífera*, and claims his name as having the priority: he got the seed from St. Domingo, as a new *Datùra*. It has flowered freely with him ever since he raised it, and is now common here. Mr. Smith has also a new *Datùra* in flower, from seed received from South America; it has a large white flower, which is axillary. Mr. Smith has many other new plants from seed, which have not yet flowered. His collection, indeed, is much the best, as that of an amateur, in this country. He has been very successful in raising tropical plants from seed; and he has also raised some very superior seedling camellias.

*Epigæa rèpens*. I see it mentioned, in one of your last year's Numbers, that Mr. Thompson of the Mile End Nursery had raised a variety of the *Epigæa rèpens* with pink flowers. Are you aware that that is the colour in general in the natural state, a white variety being very uncommon? — X. Y.

We shall be particularly obliged to this correspondent, if he will let us hear from him frequently. Mr. R. had not called with the root, at the time (Feb. 12.) this letter was sent to the printer. — *Cond.*

### ART. III. Domestic Notices.

#### ENGLAND.

*THE new Range of Glass now erecting in the Horticultural Society's Garden.*  
— [The following is an extract from the *Botanical Register* for February.] —  
All who are interested in the cultivation of exotic plants will be glad to learn  
VOL. XV. — No. 108. L

that the Horticultural Society of London are about to erect a most extensive conservatory in the garden at Chiswick. The range will be nearly 500 ft. long, running east and west, with a front both to the north and south. The roof will be constructed entirely of iron, glazed with patent sheet glass, and will have the form of a Gothic arch. The west wing, rather more than 180 ft. long, and 27 ft. high, has been contracted for by Messrs. D. & E. Bailey of Holborn, and will probably be completed by the middle of May. The whole range, when executed, will be one of the most extensive in the world. No association of individuals has ever introduced so large a quantity of beautiful and useful plants into this country, as have been procured by the funds of the Horticultural Society of London; but those plants have necessarily been confined very much to hardy species, in consequence of the want of extensive glass houses. It is now to be expected that green-house and stove plants, especially the former, will become a great object of attention with the Society; the effect of which will doubtless be, to improve the ornamental character of tender plants in the same degree as that of hardy collections. Few persons know how many objects are within their reach, the beauty of which is far beyond anything now in our gardens, and that only require space in which to grow them. (*Bot. Reg.*, 1839, *Month. Chron.*, p. 17.) This information is to a certain extent gratifying; but, when we consider that the kitchen-garden department is in a great measure given up, that the unique collection of ananas is sold, and that the experimental ground is now turned into a botanic garden, we confess it does appear to us a most unjustifiable mode of disposing of the income or credit of the Society. In our opinion, one of the principal objects of the Society ought to be, to have, in the kitchen-garden department, specimens of all the best varieties of culinary vegetables; including all the new sorts, whether originated in Britain, on the Continent, in America, or, indeed, in any other part of the world. The value of these new sorts ought to be tested, and made known to the public from time to time. The Society, as we think, ought to publish a catalogue of culinary vegetables, with all their synonymes, in the same manner as they have done a fruit catalogue; which *Fruit Catalogue*, every one knows, has been of immense service to the country. In short, the fruit department of the Society, and the scientific examination of the young gardeners, are the redeeming points of the establishment. It may be said, that varieties of culinary vegetables are continually changing, and that, as kinds of cabbage, peas, spinach, &c., which are considered the best at one time, in a few years give place to others that are reckoned better, a catalogue could not be of permanent use. We allow this; but we consider it one of the strongest arguments for keeping up the kitchen-garden department. Such a catalogue as we have recommended would only occupy a few pages, and might easily be rendered efficient by frequent editions, as, indeed, there ought to be of the fruit catalogue.

By displaying, in the kitchen-garden of the Society, well-grown specimens of all the best culinary vegetables, conspicuously named, gentlemen and their gardeners, as well as the innumerable persons about London who visit the gardens in the course of the summer, would see them, and be able to order from their seedsmen, or to ask for from their greengrocer, kinds which they had previously known nothing of but the name, and, perhaps, not even that. By briefly describing all these varieties in a catalogue, a similar result would take place with respect to gardeners living at a distance; and the best varieties would thus come far sooner into general cultivation than they do at present. What gardener, for example, would continue sowing those miserable little peas, the frame and the Charlton, while he could procure any of the large succulent early kinds, such as Bishop's early dwarf, the dwarf fan, &c. In many parts of the country, the Upsal cabbage is still considered the best early variety, by persons who know nothing of Knight's early varieties, and others which are grown by the market-gardeners about London. Who would sow the common spinach that had ever seen the Flanders variety? And so on.



However interesting house plants may be, they can only be obtained by persons possessing large establishments; and it must be allowed that hardy plants, whether ligneous or herbaceous, useful or ornamental, are of most importance to the country in general; and, therefore, the introduction of these ought to be considered of paramount importance, not only with reference to the general good, but to the specific object for which the Society was instituted, as appears by their charter and the earlier volumes of their *Transactions*.

These things being attended to in the first place, as being the main objects for which the Society was instituted, the introduction and culture of house-plants would afterwards be just and proper. At present, we consider it altogether unjustifiable; though we confess that it is not without some pain that we express our disapprobation of the Society's proceedings in so decided a manner. We do it, however, with the most perfect good feeling to all the parties concerned, and simply because we consider it our duty to do so. We have not the least idea that our suggestions will be attended to; because that would imply a complete reformation in the manner of conducting the Society's affairs, and the members, and the public generally, are much too indifferent about the matter to take the trouble sufficient for that purpose. Things, we suppose, must go on as they are, till by some means or other the pockets of the members are touched, and then a reform will be generally called for, and obtained.

It has more than once been suggested to the Society, in this Magazine, that they might do something towards the introduction, into our public vegetable markets, of blanched succory leaves during the winter season. This most wholesome and agreeable salad is in common use by the humblest individuals, throughout the whole winter, in Belgium, and in other parts of the Continent, and would surely form a most desirable auxiliary vegetable in London, and in our large manufacturing towns. By offering premiums for the largest quantities brought to market, the Society might be the means of introducing this salad into general use; and we would ask whether even the introduction of this simple vegetable would not be more in accordance with the intentions of the founders of the Society, than the introduction of expensive house plants. The culture of the truffle and the morel, in our opinion, also deserves the attention of the Society; though it is clear, after what we have said on the subject in our preceding Volume, that the managers of the institution think otherwise.

Having entered our protest against the present pursuits of the Society, we have done our duty, and thereby satisfied our own conscience. — *Cond.*

*Gárrya laurifolia*. — Seeds of this interesting, hardy, evergreen shrub have been distributed by the Horticultural Society, so that we trust so very desirable an addition to our evergreens will soon find its way into nursery commerce. Cones of the Ocote pine of the Mexicans (? *P. oocárpa Schiede*, or *P. Teocóte* Lamb.; *Arboretum Britannicum*, p. 2266.), seeds of *A'rbutus densiflóra*, *Prúnus Capóllin* (Capulin of the Mexicans), and *Cratægus mexicana*, have also been distributed; together with seeds and bulbs of some green-house and herbaceous plants. The whole were sent from Mexico to the Society, by their collector, M. Hartweg. — *Cond.*

*Importation of Cácti, Orchídeæ, &c.* — A very large collection of Cácti has just been received from the Spanish Main, from the collector sent thither by Messrs. Lowe & Co., of the Clapton Nursery, and Thomas Harris, Esq., of Kingsbury. Nearly at the same time, another large collection arrived from Mexico, and was divided between the Kingsbury collection, and that at Woburn Abbey. The collector sent out by Mr. Harris and Messrs. Lowe and Co. promises to be one of the most active ever employed; and he has the advantage of Mr. Henchman's previous knowledge of the routes which he is to take; of Mr. Beaton's knowledge of the constitution of Cácti; and of being thoroughly acquainted with the Clapton manner of packing, the most essential qualification of a botanical collector. This collector, whose name is

Charles M'Kenzie, arrived in the Spanish Main in the first week of September, and, by the middle of November, had gathered and packed between 600 and 700 plants of *Cácti*, *Orchídeæ*, &c., with a large assortment of seeds, roots, &c., including a dwarf *Euphórbia*, of elegant habit and beautiful foliage. All these arrived in the most perfect state of preservation; indeed, the cereuses and melocactuses are as fresh as when gathered, although almost wrecked off the coast of Ireland, and detained between Cork and Liverpool nearly five weeks during the late frosts.

The following articles from the Kingsbury portion of the above importations were exhibited at the meeting of the Horticultural Society, held February 19th. A specimen of *Cereus senilis*, 5 ft. 3 in. long; another 3 ft. 6 in. long, and others of the same species, in various stages of growth, showing the different states of this singular species from 2 in. to 5 ft. in height. The smallest of these, a dead specimen, although only 2 in. high, and supposed by Mr. Beaton to have been only about 18 months old when taken up, showed all the characteristic features of the "old man;" having its grey-hair-like (?) urceolæ as strongly marked as that of any of its older brethren. It was procured from Mexico, and exhibited in order to establish the fact that the hair is produced in this species in the seedling state; a fact of which Mr. Beaton was not aware last year, when he exhibited seedlings of a very different species, supposing them to be those of *C. senilis*; the seeds from which those plants were raised having been purchased for those of *C. senilis*. Several other long cereuses, and some melocactuses not yet described; a curious root or tuber, which bore some resemblance to the hand of an ape; a new (?) orchideous plant, with large, long, pseudo-bulbs, not unlike those of *Dendrobium speciosum*, and two fine specimens of *Elephantopus*, the bulb-like masses of which are a great acquisition to a grotesque collection of plants, such as *Cácti*, &c. The *Cácti* were not exhibited for a prize, but to show that these plants could be brought over in the depth of winter, when carefully taken up and safely packed.

Besides these, Mr. Harris exhibited an exceedingly handsome-flowering stove acacia, with inga-like flowers, of the most exquisite colour and texture. Mr. Harris does not exhibit any plants except new ones when they first flower with him; or any real good old ones, such as the acacia, or inga, above named, which ought to be more generally known.

Mr. Harris's unique collection is open to the inspection of the botanical world every Wednesday throughout the year; but, to prevent this commendable liberality from being abused, it is necessary that strangers be either already known as scientific botanists, or furnished with an introduction from some botanist or botanical patron. — *Cond.*

*The Royale Hâtive Plum.* — In the *Proceedings of the Horticultural Society*, No. 4., you will find mention made of the *Royale Hâtive* plum, an excellent variety, rivalling the *Reine Claude Violette* in excellence; and I think it will be about a fortnight earlier. Shoots very *downy*; those of the *Reine Claude Violette smooth*, which might have been observed and noted as a dissimilarity by the French authors, when they compared the two in the *Bon Jardinier*. — *R. T.*

*Van Mons Léon le Clerc Pear.* — Latterly a new pear has made its appearance, and is also noticed in the *Proceedings*, No. 4., called the *Van Mons Léon le Clerc*\*, not *Vomons Léon le Clere*, as you will perceive it advertised by M. René Langlier, of Jersey.

There has been a *Léon le Clerc* pear in cultivation for several years, and it is necessary to guard against confusion, and, perhaps, much disappointment, by observing that *Léon le Clerc* is totally different from the *Van Mons Léon le Clerc*; the former being only a stewing pear with flesh tough as that of *Uvedale's St. Germain*; the other is quite a *beurré*. The royal *hâtive* plum, and the

---

\* M. Léon le Clerc, of Laval, wished the name of *Van Mons* to be conjoined with his own, in the name of this fruit.

Léon le Clerc pear, are both very valuable acquisitions, and should be included in every selection. — *Id.*

---

#### ART. IV. *Retrospective Criticism.*

**ERRATUM.** — In page 94. line 5., for “(slate stoves),” read “(I hate stoves).”

*Raising Cacti from Seeds taken from dead Specimens.* — Seeing in the *Gardener's Magazine*, p. 29., an extract from M<sup>r</sup>Intosh's *Green-house, Hot-house, and Stove*, on Cacti raised from seed derived from dead plants, allow me to state that, from a small purchase at the same sale as that referred to in your review, I succeeded in obtaining seed from several species of *Mammillaria* and *Echinocactus*, and thus procured a considerable quantity of young plants. After the old plants were potted and excited, their first effort was, apparently, to throw up their seed-vessels, especially the *mammillarias*, the berries showing very slight traces on their summits of the withered floral organs; it thus seeming that they flowered previously to their being packed, or during their voyage. From some dead *Echinocacti*, I also procured seed by pulling them to pieces, and thus preserved those species.

Is it not a mistake, to say that these plants will throw up their seed-vessels, “even long after they are dead?” Is it not rather the result of the impregnated embryos drawing a sufficient supply of elaborated sap from the withering plant to perfect their seeds? I well know that several plants belonging to *Tulipacææ*, and other related orders, will, while drying for the herbarium, swell their capsules to nearly their full size; and I once had a specimen of *Calochortus luteus* form bulbs on the edges of the compressed flower-stalk (not in the axils of the leaves) while drying, from which bulbs I raised plants. These instances will, perhaps, assist to explain the throwing up of their seed-vessels by the *drying Cacti*. — *A young Subscriber. Jan. 18. 1839.*

*Calling of the Queen Bees, &c. (p. 25.)* — I have just been perusing Mr. Wighton's article on the “calling of the queen bees before swarming;” and, although I have had the management of bees for upwards of twelve years, I have never been able to see what was going on at the time this calling took place but once; and, as it may be interesting to Mr. Wighton, as well as others, I will relate, as nearly as my memory will enable me, what I then observed. As our bees are not very near the house, it is my practice, in swarming time (when I have any reason to expect a swarm), to walk to the apiary about 10 o'clock, to ascertain if any hives are getting very busy, in which case I place some one to work near the spot. Going one morning to a hive I expected to send forth a swarm, I was amused at the sound of “peep, peep;” but not, as Mr. Wighton states, always coming “from certain fixed points.” Feeling interested in what might be the result, I continued my observations till the swarm came out, which I think was in about an hour from the time I first heard it; but I think it is probable it had been going on for a considerable time before. This sound of “peep, peep,” came from an old queen, whom I could plainly see going from one part of the hive to the other; running in a hurried manner, as though anxious to escape, and uttering the call in a hoarse kind of way every time she stopped. During the time this was going on, there was, as Mr. Wighton observes, another sound of “peep, peep,” of a shriller kind, from a fixed point; but it was in the interior of the hive, and, consequently, out of the reach of my observation. As I stated before, this continued about an hour, when the swarm issued forth; but, whether the queen who ought to have accompanied it was destroyed in the hive, or lost after she came out, I cannot say; but, almost as soon as the bees were out they returned to the parent stock, and never after made an attempt to swarm, neither was there any more confusion in the hive, nor sound of “peep” from either old or young queens, but all went on as peaceably as though nothing

had happened. This, Mr. Wighton will please to observe, was before the first swarm, which, from his letter, does not appear to have been the case with his. If these remarks should be of any service to Mr. Wighton, I shall be happy that I have embraced the opportunity of sending them.—*B. Feb. 1839.*

*Calling of the Queen Bees before Swarming.* (p. 25.)—Nearly twenty years ago, I sent to the *Edinburgh Philosophical Journal* an account of some observations I had made on the proceedings of the queen bee during the swarming season. By the help of an experimental hive, which I had constructed, I made some interesting discoveries on that subject, of no very great importance certainly, yet adding some little to our stock of bee-knowledge. Of these discoveries, perhaps the one most worthy of notice related to the piping of the queen; and I am induced, for the satisfaction of your correspondent, Mr. Wighton, in your last Number, who has very modestly and ingeniously stated his belief on the subject, to give the *rationale* of the said piping.

In the month of May, earlier or later, according to the locality, the season, and other circumstances, the queen begins to lay eggs in the royal cells, which the workers, instinctively aware of the necessity, had previously constructed. These eggs are deposited, generally, at intervals of twenty-four hours, though sometimes at longer intervening periods; thus causing a succession of young queens, hatched at different periods, to head successive swarms.

When the first-laid of these eggs is hatched, and the larva, or worm, then produced is about to be transformed into a nymph, and before the royal cell so inhabited is finally closed, a period occupying altogether about eight days, the old queen leaves the hive with the first swarm. The family left behind is then without a head, and it is not till the 5th, 6th, or 7th day, according to circumstances, that the senior of the young queens leaves her cell. Instantly on her emerging, she flies to the cradles of the remaining royal brood, and eagerly attempts to tear open the cells and destroy the inmates. But the working bees interpose most effectually, guarding the cells with the most determined firmness, and repulsing the violence of the queen without any ceremony; for I have seen, on such occasions, half a dozen bees hanging close on her skirts; one hauling at each leg or wing, and forcing her away from the spot. At every repulse the discomfited queen stands sulkily hard by, moving her wings across her back without expanding them, and utters the well-known *peep, peep, peep*; sounds expressive of her anger and irritation at her deadly attempts being frustrated. After a minute or two have elapsed, she repeats the assault, is again defeated, and again gives vent to her wrath in the same cry. And this scene of violence continues almost without intermission for three days, sometimes longer; when the queen, irritated at last beyond endurance, traverses the hive in a state of great agitation; communicates that excitement to the workers; and, finally, leaves the hive with a great mass of the population; thus forming the second swarm.

The same process goes on with the next in seniority of the royal brood, providing the population be abundant; but at a shorter interval of time, corresponding with the interval between the laying of the royal eggs.

Mr. Wighton notices correctly the fact of several queens piping at the same time, though the sounds are somewhat different. The shrill sound, consisting of a long succession of clear notes, proceeds from the hatched queen, and is heard in different quarters of the hive, as she moves from one cell to another, to attempt the destruction of their respective inmates. The other sounds are of a hoarser kind, somewhat resembling the quack of a duckling, and proceed from the queens that are still prisoners in their cells; the sounds being stronger or weaker according to the age of the insects, and always proceeding from the same fixed points. Such is the *rationale* of the piping of the queen; and I shall be glad if your correspondent is satisfied with it. I witness the process every summer, as any one may who possesses the facilities afforded by an experimental hive like that I have mentioned.

Were I asked how it happens that the piping is not heard before the *first* swarm, I should be at a loss to give a satisfactory reason. There are many facts in the natural history of the bee, as in that of other animals, which we can attest the existence of, without being able to give the *ratio quare*. This, perhaps, is one of them; and we are just cutting the knot which we cannot untie, by saying that Nature has so willed it; but of the secret means she employs to induce the old queen to leave her abode, without having recourse to the same violence towards her successors, as these last offer to theirs, even Huber acknowledges we must confess our ignorance. We cannot but perceive, however, how wisely it is provided, that she is not so fiercely disposed; otherwise the race would ultimately be extinguished. For, be it observed, no opposition would be offered by the workers to such attempts by the *old* queen. The rudeness and violence with which they oppose the *young virgin queens* are never offered to the venerable *mother* of the hive. She reigns supreme, and she is at liberty, if so disposed, to destroy every scion of the royal stock. Nor is this to be regarded as fanciful theory; in certain circumstances it is realised. If, after the eggs have been laid in the royal cells, there is a series of dark or stormy weather, the sensitive old queen declines going forth, and continues snugly at home, while in the mean time the royal larvæ are sealed up in their cells, and undergo their metamorphosis into nymphs; when the innate abhorrence of her rivals, peculiar to the royal blood, bursts forth, and she proceeds, without opposition, to effect the destruction of the whole.

I have said that the working-bees never oppose the mother of the hive, when bloodily inclined. This is the fact; but we are not on that account to give them credit for affections akin to those of humanity. It is not from feelings of filial love and regard towards their parent, but upon the utilitarian principle, simply because she is a mother, and, as such, capable of continuing the race. For after the old queen has taken her departure with the first swarm, and one of the younger ones has emerged from her cell, should the latter, as sometimes happens, instead of occupying herself with vain attempts to murder her royal sisters, go quietly abroad in quest of the males, and succeed in her mission, she is received on her return with hearty welcome, and implicit submission on the part of the workers; her sovereignty acknowledged, and her murderous assaults on her rivals witnessed in silence. And, after the deed is completed, the bees forthwith remove the dead bodies, and then resume their ordinary labours with their accustomed industry and despatch. — *William Dunbar. Applegarth Manse, Dumfriesshire, January 14. 1839.*

*List of Fruits in the Suburban Horticulturist.* — As it is desirable that the lists of fruits, in your forthcoming *Suburban Horticulturist*, should be as free from error as possible; I therefore take the liberty of calling your attention to one or two matters. I lately purchased, from Mr. Lee of Hammersmith, the Pourprée hâive peach. He asserts that both he and Mr. Thompson have proved it to be the same as the Grosse mignonne, though these two are, both by you and Lindley, arranged in different classes.

There is some confusion between the Diaprée rouge, Mimms, and Imperial diadem plums, as may be seen on comparing them in *Lindley*, the *Horticultural Catalogue*, and your list in the *Encyclopædia of Gardening*. It seems to me, that, in plums (I mean in *some* of them), down on the shoots is not sufficiently marked to form a specific difference. Why not take notice of the leaves at least, in some varieties which are strikingly different from others? Also the glands at the foot of the leaves seem worthy of consideration.

Lindley mentions an apple which, from his description, seems worthy of attention as an autumn fruit, viz. the Pine-apple russet, or Hardingham russet of the Norwich gardens. (See *Lindley's Guide*, No. 180.) Though an old apple, it is not noticed at all in the *Horticultural Catalogue*. I was anxious to get a tree of it, but it is not to be had in London. I intend begging of Lee to get me a plant from Norwich. I am sorry nothing decisive

is yet known about the Beurré Spence pear: before you publish, I hope you will get some information on the subject. We have a favourite apple through at least one half of Ireland, which seems not as much known as it deserves in England, viz. the Scarlet Crofton. It is very peculiar in its taste, and never becomes mealy; and keeps well.—*N. H. Graves. Brigown Glebe, Mitchelstown, near Cork, Feb. 1. 1839.*

On sending the above letter to Mr. Thompson, he returned it, with the following remarks:—

The Grosse mignonne peach was found in so many collections under the name of Pourprée hâtive, that it was thought proper to mark the Grosse mignonne as being the *Pourprée hâtive* (of some), in the *Horticultural Society's Catalogue of Fruits*; and likewise in the new edition of the *Encyclopædia of Gardening*. The true *Pourprée hâtive* is, however, perfectly distinct; its leaves having reniform glands, whereas those of the Grosse mignonne are globose. The fruit ripens earlier than that of the Grosse mignonne (see the above-mentioned publication). The London nurseryman, who properly informed Mr. Graves of the identity of the sort which was sent with that above-mentioned, will doubtless lose no time in obtaining the distinct sort, which, in fact, is rather scarce in this country. It may be obtained from the nursery of Messrs. Baumann of Bollwyller, under the name of *Pourprée hâtive à grandes Fleurs*.

The Mimms plum, and the Imperial diadem of some, are undoubtedly the same as the Diaprée rouge of the *New Du Hamel*, t. 55.

With regard to the varieties of fruits, there is scarcely such a thing as specific differences to be met with: the same objection that applies to that arising from the shoots being downy or smooth is also applicable to every other mark of distinction that has yet been discovered. Yet, in some, the wood being downy or smooth leads to perfect decision: thus, the Reine Claude Violette has smooth shoots; another variety of plum, the Royale hâtive has fruit very similar, and the two might be easily mistaken one for the other, were it not observed that the shoots of the Royale hâtive are exceedingly downy.

The Pine-apple russet is not known about London. The Pine-apple pippin is, perhaps, the same variety. Moreover, this will doubtless be eventually ascertained.

The Beurré Spence is not yet known in this country. An excellent pear was seen this season under the above name, but it was believed to be the Urbaniste.—*R. T. Feb. 6. 1839*

---

#### ART. V. *Queries and Answers.*

*A LARGE Grape, raised by Van Mons.*—The *Journal of Science and Art*, vol. xxvii. p. 229., contains the following extract from a work on vines, by M. Lenoir, a French writer:—“A seedling vine, raised by M. Van Mons, at Brussels, produces fruit as large as a green gage plum, which, at the latest, ripens in the first fortnight of August, and never fails. Its qualities are no less remarkable, as it is both solid and sweet.” Can this grape be procured in England?—*J. B. W.* We have written to Dr. Van Mons, and also to M. Vilmorin, respecting this grape, but we have not yet received any satisfactory answer.—*Cond.*

*A drooping Larch.*—Are there such things anywhere for sale as true or genuine drooping larches, which, if worked in the manner of the drooping ash, will grow downwards? And, if there is, what is the price? I do not mean the merely curved or tortuous larches which are generally styled droopers in the nurseries.—*X. Nov., 1838.*

---

THE  
GARDENER'S MAGAZINE,  
APRIL, 1839.

---

ORIGINAL COMMUNICATIONS.

ART. I. *On the Extension and Use of the Cacti.* By Professor ZUCCARINI, Subcurator of the Royal Botanic Garden at Munich.\*

(Translated from the "Garten Zeitung" of 1837, vol. v. p. 57., by J. L.)

ALTHOUGH in the year 1799 Willdenow enumerated only 29 Cacti, and Persoon only 32 in 1807, the number of species has increased, since the latter period, with such rapidity, that De Candolle, in 1828, acknowledged 162 decided species; and now those contained in the largest collections, taken together, certainly amount to more than 500 living species in cultivation; we know that we are yet far from having a perfect knowledge of this family. The Cacti extend in nature over a space of 95° degrees of latitude, and yet but very few of the localities are sufficiently explored; a neglect which is so much the more to be lamented, as it has been observed that some particular species (with the exception of the Opuntias in cultivation) are confined to very small localities. All travellers who have visited the temperate and tropical parts of America speak of the enormous number of Cacti they saw there; but, instead of rendering us better acquainted with the species, they only make a general complaint of the annoyance occasioned by these vegetables, and of the barrenness of the soil in which they grow; and many of them, nay, even the very best collectors, openly confess that they consider the Cacti among their greatest enemies. Even Pöppig, one of the most zealous and correct observers, expresses his aversion from them in his *Travels*.†

They are certainly not calculated for herbariums, and even their descriptions from life, unless accompanied by accurate drawings on the spot, would not be sufficient to give a correct idea of them; but, as they will bear without injury a journey of several months' duration, it is much to be lamented that, in modern times, they are more frequently brought over by amateurs than by professional men. It is true, that Baron von Karwinski, Dr. Coulter, Schiede, and others, have brought an amazing number of Cacti from Mexico to Europe; but each of these botanists always found again new species in the localities not far separated.

When Brazil, Peru, Chile, and Paraguay are once thoroughly explored, the Antilles will unfold their treasures; and it is cheering to see the predilection

---

\* Extracted from *Plantarum novarum vel minus cognitarum, quæ in Horto Herbarioque regio Monacensi servantur, Fasciculus tertius: Cactææ*. Descripsit Dr. Joseph Gerh. Zuccarini. Memoirs of the Mathematical Physic Class of the Royal Academy of Sciences at Munich, vol. ii. 1837.

† His expressions are: "In travelling, plants are met with, which we soon feel may truly be called our enemies, and among those may be reckoned the tree kind of torch thistles, which abound in Chile, and continually meet the eye wherever you turn." (*Travels*, vol. i. p. 229.) And again, in vol. ii. p. 145: "And, as the abominable Cactus vegetation everywhere continually annoys in Peru and Chile, so is it also about Huanuco," &c.

of late years for plants that have formerly been neglected. Palms, tropical Orchídeæ, and *Cácti*, formerly only few in number and rare in European collections, now occupy a large space in our hot-houses, and reward our care by their luxuriant growth; and the value that is set on them increases the love for their scientific cultivation.

The *Cácti* are found in their native country, either in a wild state where they spring up spontaneously, or where they are cultivated as useful plants.

The *Cácti* in the wild state, are found in all the warm and temperate regions of the new continent, extending to a latitude of more than  $95^{\circ}$ , and from the level of the sea, near the equator, to a height of 1,500 ft., an extent which few families of plants of similar limited localities possess. They also extend, in a cultivated, wild, or doubtfully wild, state, over a great part of the warmer countries of Europe, Asia, and Africa.

We will, in the first place, speak of those in the wild state in America. The most northern point in which the *Cáctus* has been found growing wild is close beyond the boundary of the United States, on an island in the Lake of the Woods, about  $49^{\circ}$  of north latitude, where Captain Back and his companions were very much annoyed by an amazing number of very prickly opuntias, growing among thick low grass. They are also found in abundance in the western part of the country, of which Hooker says in his *Flora Boreali-Americana*, p. 229.: "It is much to be lamented, that no collection of *Cácti* can be made, on account of the impossibility of drying them. If I am not mistaken, some species were collected by Drummond, and certainly by Douglas, on the west side of the Rocky Mountains, at  $44^{\circ}$  and  $45^{\circ}$  north latitude, and at a considerable height up the mountains. Probably they were the same, or some nearly allied to them, which Nuttall discovered on the high mountains on the Missouri, and in the district of Wandan (also in about the same latitude), viz. *Mammillária simplex*, *Mamm. vivípara Haw.*, and *Opúntia frágilis Nutt.*" Pursh mentions only one species between New Jersey and Carolina, found in scanty forests of fir, and in sandy fields. He calls it *Cáctus Opúntia*, and says that their edible fruit is known by the name of the Prickly Pear. We have many examples of the continued extent of this family, through all the countries on the Mexican coast, the Antilles, and as far as California; and we are also aware that an extraordinary number of species exists on the enormous South American continent, extending to the southern boundary of Chile.

It is not exactly ascertained at what southern point these plants cease to grow, but it is well known that several species are found on the continent south of Conception. Meyen says that the *Cáctus chilénsis* is found at a height of from 4,500 ft. to 5,000 ft. above the level of the sea, in the vicinity of St. Jago, in Chile, between  $33^{\circ}$  and  $34^{\circ}$  south latitude, on the coast of San Anzico; and, according to Pöppig's observations, the opuntias and melocacti are found on the Cambre, near St. Rosa, nearly under the level of the sea, at  $33^{\circ}$  south latitude; and they grow also at the height of at least 9000 ft. above the level of the sea\*, which seems to indicate that they have a very extensive southern range. The most southern point where they have been found is nearly at  $45^{\circ}$  south latitude in the Archipelago de los Chinos y Huayticas, where, according to Pöppig, there are large plains covered with the *Cáctus coquimbána Molina*. If we, therefore, calculate from the southern limit of  $45^{\circ}$ , to the northern point of  $49^{\circ}$ , there will be found an extent of

---

\* Our night encampment was on the previous evening, at a height of 7500 ft. The next morning, after a very steep ascent, Pöppig came to a spot of which he says: "The large pillars of the different kinds of *Cèreus* disappear for ever; but the smaller members of this genus are found in abundance in this frosty region. The *Opúntia*, with its wedge-shaped joints, and the generally woolly *Cácti*, form large groups between the sharp-cornered stones, which one cannot pass by without much trouble." (*Pöppig's Travels*, vol. i. p. 212.)



94° for the native country of this family. The distribution of the genera throughout this extensive range will be treated of hereafter.

The height at which they grow above the level of the sea is ascertained in many situations, but, unfortunately, Hooker does not mention how high Douglas found *Cácti* in 44° north latitude on the Rocky Mountains; but, from all appearances, we may at least conclude that the height must be about 3,000 ft. The most considerable southern elevation given by Meyen is 5,000 ft. under 34° south latitude; and by Pöppig, nearly 9,000 ft. under 33° in Chile. The elevation in Peru is given by Meyen, in which, on the enormous table-land on the Lake of Titicaca, the *Cereus* and *Pereskia* grow; and near the town of Ehuquito, 16° south latitude, according to Pentland, they are found at a height of 13,000 English feet; and in the Cordilleras of Tacua, more to the south, nearly under 18°, he states that the wonderful dwarf-like *Pereskia* is found still higher, viz. nearly 500 ft. below the limit of eternal snow. A. von Humboldt gives the like information for Quito. At the foot of the Chimborazo, near Riobamba, he observed upright torch thistles (*Cereus setium* *H. B. & K.*) at a height of 1,480 fathoms, therefore nearly 9000 ft. Von Martius observes that in Brazil the *Cacti* grow to the tops of the chain of mountains, which, without them, would be proportionably low; and Baron von Karwinski found some *Mammillariæ* and small short-jointed *Cerei* in Mexico, near San Jozé de Loro, on the top of the Cerro de la Vinda, at a height of 11,000 ft. above the level of the sea.

The amazing extent of the distribution of this family naturally occasions a great variety in the localities; of particular species. It must, however, be observed, that, with the exception of the cultivated *Opuntia* and *Cacti*, all the other species are confined to small localities, and that, therefore, information, such as that given by Meyen, of the appearance of the Mexican *Cereus senilis* on the Andes in Chile, was probably supposed to be incorrect, from want of such information. The under strata of the soil seem to be various, as I have found particular species on chalk, sandstone, primitive rock, and on volcanic remains, porphyry, &c. They are generally at a distance from the sea coast, where the soil is not impregnated with salt; yet Moritz found a great number of *Cacti*, and even *Meloçacti*, near La Guayra, not far from Caraccas, close to the sea shore, among the tufts of *Coccoloba uvifera*, *Hippomane Mancinella*, &c. &c. A similar remark was made by Baron von Karwinski on Cuba, where the *Cereus baxanus*, a new species nearly allied to *C. grandiflorus*, and some *Opuntia*, were found growing in abundance in company with the common plants on the sea shore. Particular species in the interior of the country seem to prefer somewhat the same kind of soil; as they, with the exception of the *Pereskia*, grow in sunny open situations; and they seem to get sufficient nourishment from the poor soil, and even thrive on heaps of stones, on loose sand, or in the narrowest chinks of the rocks. The former is particularly the case with the tree kinds of *Cereus* and *Opuntia*, in the low-lying parts of the country; and all travellers agree that the districts where such forests of *Cacti* grow are exceedingly barren, and almost destitute of other plants.

It is different with the species of the more temperate regions. The *Mammillaria* and *Echinocacti* of Mexico grow, according to Baron von Karwinski, on a loamy, but by no means unfruitful, high plain, among low grass, and only sometimes in the crevices of rocks, &c. Those species, also, which grow on the Alps, grow in good soil, although they have a most miserable appearance.

It is an error to suppose that all the *Cacti* prefer dry situations. It may certainly be the case with the large Cardones of the warm valleys, but it is not so with many of the very numerous species of the Tierra templada. Those, for example, in Mexico, have five months of continued rain, viz. from June to October, but stand the other seven months of the year quite well, in a perfectly dry state; a circumstance which, in the culture of the *Mammillariæ* and *Echinocacti*, should be particularly attended to.

It is evident, from the degrees of latitude and the elevations of the localities in which the different species grow, that the temperature must be very various.

In general, it should be observed, that the species of *Melocactus* and *Rhípsalis*, as peculiarly belonging to the tropics, require the greatest degree of heat, and are kept in houses at a moderate heat of at least  $+15^{\circ}$  Réaumur; to which may be added the greater number of the *Cereus*, some *Epiphyllums*, and *Opuntias* of the valleys, and the greater number of the *Pereskias*. The *Mammillarias* and *Echinocacti* of the higher plains of Mexico do not require so high a temperature; but they must have an equal heat all the year round, as the variations of temperature are but little felt in their native localities. It is, on the contrary, very different with the Alpine and subalpine plants, such, for instance, as *Mammillària vétula* and *M. supertéxta*, which, at a height of 11,000 ft. stand the winter's cold, and must endure the frozen soil for the space of one month; and a still greater severity attends the wonderful *Pereskias*, *Opuntias*, *Cereuses*, and *Echinocacti* of Chile and Peru, which grow to within a few hundred feet of perpetual snow, and stand all the severity of an alpine winter, with the tops of their stems sometimes covered with snow; and how unsusceptible of the variation in the temperature must those *Opuntias* and *Mammillarias* be, which are situated on the northern and southern limits of their extension in North America, under  $49^{\circ}$  north latitude, or on the Rocky Mountains, at  $44^{\circ}$  north latitude; where their habitat is several thousand feet above the level of the sea! Here, also, may be mentioned the *Opúntia itálica*, on account of its wide extension in Europe, which is found under  $47^{\circ}$  north latitude, in the warm alpine valleys; and stands a cold, in winter, of from  $6^{\circ}$  to  $8^{\circ}$  of Réaumur.

From what has been said, it may be seen that the climate which suits the different kinds of *Cacti* extends from the heat of the tropics to the temperature of the colder temperate regions; and that, therefore, it is impossible to cultivate all the species with the same success, in the same degree of heat. It is true, indeed, that many of the species can accommodate themselves, in some degree, to a change of climate; but the consequence would be an evident alteration in their growth, and in the whole habit of the plant; and even with the most careful cultivation, particular species would vary from their normal state, either in consequence of too much heat, or *vice versá*; so that by such treatment some would degenerate into wild plants, and produce formidable thorns, or would be covered with wool, as they are in their native localities.

It will also be unsuitable for the *Melocacti*, *Cerei*, and *Opúntiæ*, which require a hot-house, and are accustomed to a poor soil, to have an equal mixture of soil to grow in; for the *Epiphýlla* which are parasitical, and obtain their nourishment more or less from wood; and for *Mammillària* and *Echinocacti* of the temperate zone, which grow on the most fruitful soil.

In general, however, a nourishing and not too light a soil will be found advantageous to all *Cacti*, if the moisture be supplied at the proper time, and the period of their drought in their native country be observed, when they should have very little or no water with us; and plenty of water given, on the contrary, when the rainy season of their native country comes on: and, as all this refers to particular species, we can only get the proper information of their growth through the more attentive observations of travellers, which, unfortunately, we have hitherto not been able to obtain. I have, therefore, considered it of importance to add, in a note, some information on the native soils of the Mexican *Cacti*, for which I am indebted to the kindness of Baron von Karwinski.\*

---

\* Where no particular kind of soil is mentioned, it may be understood to be more or less of loam and rich soil. *Cereus baxànus Karw.*, Cuba, on the sea shore, on sand. *Cereus ramòsus Karw.*, *Epiphýllum látifrons Zucc.*, in the tropics, between Cordova and Vera Cruz, on clayey soil.—In the temperate parts (tierra templada), near Zimapan, are found *Cereus Díckyü Mart.*, *C. erectus Karw.*, *C. geometrízans Mart.*, and *C. dichroacánthus Mart.*, *Echinocactus leucántha Zucc.*, *Mammillària crucígera Mart.*, *M. inúncta Hoffmssgg.*, *Echinocactus íngens Karw.*, *Mammillària columnàris*, *M. polythèle*, *M. quadrispina Mart.*, on unpro-

We have now only to say a few words on the extension of the family in other countries besides America. We are informed in De Candolle's excellent *Revue de la Famille des Cactées*, p. 85., that *Rhípsalis Cassýtha* is found on the Isle de France and the Isle de Bourbon, and *Cèreus flagellifórmis* in Arabia. There are no grounds for supposing that the former, which is a parasite of unsightly appearance, was brought over from America, and become naturalised, when it is taken into consideration that the American species is there also; but this could not easily be determined with certainty from the herbariums of Commerson, Bory, and Sieber. The information respecting *Cèreus flagellifórmis* is, on the contrary, doubtful, and cannot therefore, at least at present, be cited as an example of the extension of the *Cácti* beyond America.

It is different with the *Opúntiæ*. On account of the almost endless confusion of synonymes, particularly in cultivated species, we must be permitted to deviate in some degree from the specific names, and to confine ourselves merely to the appearance of the plants generally. We may, therefore, say that the *Opúntiæ* are found wild in the old world, in Asia, over the whole Indian peninsula, extending northwards to the chain of mountains in China, in a great part of tropical Africa, and in the Canary Islands; also in all the countries of Asia, Europe, and Africa, and about the Mediterranean Sea. The northern limit in Europe is not the rocks near Final, in latitude 44°, but in Switzerland, in the canton Tessin, and the warm valleys of Tyrol, north from Botzen, in 47° north latitude.

With respect to India, we are informed by Royle that Roxburgh enumerates two kinds of *Opúntia* peculiar to that country; viz. *Cáctus índica* and *C. chinénsis*; one of which is said to be a native of India, and the other of China. One of them, probably the first, and, according to Wight and Arnott, *Opúntia Dillèni*, *Bot. Mag.*, t. 255., has also been said by Ainslie to be indi-

---

ductive stony heights, with a clayey soil, between Actopan and Zimapan. *Cèreus columna Trajàni Karw.*, on a similar soil, between Tehuacan and Loscués. *Echinocáctus recurva Haw.*, *E. gláuca Karw.*, near Ayuguesco, in the province of Oaxaca, on barren situations. *Echinocáctus phyllacántha Mart.*, *E. crispàta Mart.*, *E. anfractuósa Mart.*, *E. Karwínskü Zucc.*, *Mammillària gladiàta Mart.*, *M. pycnacántha Mart.*, *M. uberifórmis Zucc.*, *M. uncinàta Zucc.*, on maiden earth, in meadows, here and there scattered with bushes, from 5,000 ft. to 6,000 ft. above the level of the sea. *Echinocáctus oxýptera Zucc.*, *E. spína Chrísti Zucc.*, in chinks of the rocks, with some clayey earth, near St. Rosa de Toliman; and, in like manner, *E. Pfeifferi Zucc.* near Toliman. *Mammillària Karwinskiàna Zucc.*, near Yxmiquilpan. *M. Seitziana Mart.*, *M. Zuccariniàna Mart.*, *M. cárnea Zucc.*, *M. polyèdra Mart.*, *M. subpolyèdra Salm.*, *M. cirrhífera Mart.*, *M. Dyckiàna Zucc.*, *M. sphaclèta Mart.*, *M. stélla auràta Mart.*, *M. supertéxta Mart.*, between Zimapan and Yxmiquilpan. *Mammillària macrothèle Mart.*, Lehmanni L. et O., *M. brevímamma Zucc.*, *M. exúdans Zucc.*, near Actopan, in meadows about 6,000 ft. above the level of the sea. *Echinocáctus spiràlis Karw.*, at the foot of the Orizaba. *E. agglomeràta Karw.*, near Tehuacan, on sandy unproductive meadows. — On the limits of the cold region, from 7,000 ft. to 8,000 ft. above the level of the sea, near St. Pedro Nolasco, were found *Mammillària mystax Mart.*, and *M. glochidiàta Mart.*; *M. élegans Dec.*, *Acanthoplégma Lehm.*, near Yavesia, in the province of Oaxaca, on strong clayey soil. *M. rútila Zucc.*, on grassy declivities near Atotonilco el Chico, on the Serra St. Rosa, about 8,000 ft. above the level of the sea. *Cèreus flagrifórmis Zucc.*, *C. Martiànus Zucc.*, *C. gemmátus Zucc.*, in the cold region near San José del Oro, on rocks. *Mammillària vétula Mart.*, *M. supertéxta Mart.*, in the above situation, 11,000 ft. above the level of the sea. *Echinocáctus macrodíscá Mart.*, on the Cambre, at a place called El Reynosso, at a height of from 9,000 ft. to 10,000 ft. above the level of the sea.

genous to the peninsula of India; and he adds that, in consequence of the introduction of the wild cochineal on the Coromandel coast, it is almost eaten up by that insect. In the north of India, where it is also found in abundance, and where it is known by the Sanscrit name of Nagphuni, respecting which Wilson doubts as to its being a native; but, at all events, if introduced at all, it came much sooner to India than those *Opúntiæ* brought to Madras by Dr. Anderson, which soon spread all over the country; it has only been used as hedges as yet; and, on that account, the introduction of *Opúntia vulgáris* is desirable, on account of its well tasted fruit.

We have but little certain information respecting the extension of the *Cácti* in Africa. Desfontaines states that the yellow-flowering *Opúntia* is very much valued by the natives, on account of its fruit. It is very abundant in Greece, although not mentioned by Sibthorpe, and the stems are sometimes of a remarkable strength and height. Desfontaines himself possesses stems of *Opúntiæ* from Napoli di Romania, which have about 2 in. of solid wood, consisting of innumerable annual separate rings: the whole stem is 10 in. thick. As to the extension of these plants over Italy and the Tyrol, and north from Botzen, we may only mention that several species appear in the south; and in the north only *O. itálica Tenore*, or *O. vulgáris Miller*, which is found in many places in great numbers, particularly on rocky and barren grassy declivities, where no one would imagine the plant could grow.

The most interesting point in the native growth of the *Cácti* in Europe is in Spain; because it gives rise to the question, are many of the species brought to America from there, or, *vice versa*, were they brought from the new world to Spain? It is, however, very remarkable, that in all the Spanish American colonies, where the *Opuntia Tuna de Castilla* is so much cultivated on account of its edible fruit, the opinion every where is, that it was introduced by the Spaniards. The name of *Tuna*, also, is by no means American, as it is generally said to be, but originally Spanish. *Tuna*, or *higo de tuna*, *higo chumbo*, means opuntia fig; *tuno*, or *higueral de chumbos*, the opuntia forest. The word *tuno*, also, has the meaning of vagabond: and *tuna*, playing the vagabond; *andar de tuna*, gipsies or vagabonds; and, therefore, the name may have been given metaphorically, from the miserable prickly *Opuntias* growing on barren places, or in reference to the plant supplying vagabonds with food. According to Baron von Karwinski, forests of *Opúntiæ* are found in various parts of Spain, particularly in the neighbourhood of Malaga and Almeria, the historical existence of which can be traced to the time of the discovery of America, and, therefore, to a much earlier period of cultivation; probably that of the Moors, as we read in a passage of Irving's *History of the Conquest of Granada*, "that the Vega about the Moorish Veste Calóbrena is adorned with gardens, and surrounded with hedges of reeds, of aloes, and Indian figs." It would be worth ascertaining if Irving really got this information from an old book of chronicles. We are, however, far from believing that the indigenous growth of the *Cácti* in the old world is here alluded to; because, as many, with reason, believe that there was a connexion between the East and the new world long before the discovery of the latter by Columbus, it may therefore be supposed that the *Cácti* and many other useful plants were brought over to the old world, and by the Moors to Spain, whence they were afterwards reconveyed to their original native home.

We have, unfortunately, but little authentic information as to the height above the level of the sea at which the *Cácti* cease to grow in the old world. Dr. Philippi states that the *Opúntiæ* grow on Mount *Étna*, in warm valleys, where they form complete forests; and near Nicolosi they may be seen at the height of 2,200 ft., where the *Agrumi* (*Citrus* tribe) are killed to the ground by the frost. About Botzen, *O. itálica* is found at a height of 1,000 ft. above the level of the sea. Von Buch states that the highest limit of the growth of the *Opúntia* in the Canary Islands is 2,000 ft. Webb and Bertholet, on the contrary, found small mulberry and almond trees growing with the tree euphorbia 2,775 ft. above the level of the sea, in the valley of San Jago,

towards the south, on the road to Napale. The *Cácti* grow, however, only on the largest islands of the group, where they were introduced, and have been for a long time in cultivation; but none are found on the smaller islands.

We are indebted to Baron von Karwinski for the meaning of some of the Spanish and Portuguese names given to the *Cácti* in America; such as: the great pillared *cereus* is called in Mexico Cardones; the *Pereskia* and thorny *Opuntia* Espinos. The species of *Echinocáctus* are called *Visnaga*, on account of their long spines, which resemble toothpicks, the rays of the umbels of the *Visnaga* (*A'mmi Visnaga* Lam., in French Herbe aux cure-dents) being cut off and used for that purpose. The Portuguese Brazilian name of the *Echinocácti* is Cabeza do Frade, which signifies monk's hood (not monk's pate); and the word *Pitahaya*, which is used in Brazil for several kinds of *Cereus*, is by no means American, but is derived from the Spanish, in which language *pitayos* signifies a long pipe belonging to an organ.

The use of the *Cácti*, in the different situations where they grow, is more various than is generally believed. *Cerei* and *Opúntiæ* serve in many places as enclosures for pieces of land, and are sometimes used in entrenchments. In North America, the hills on which small forts are erected are thickly planted with *Yucca gloriósa*, to keep off the enemy; and so, in like manner, according to Turpin and others, the large long prickly *Opúntiæ*, and *Bromelia Pinguin*, are planted in the Spanish part of St. Domingo, with the same object. The *Opúntiæ* are used also as hedges, but they are not very suitable for the purpose, because the stems, at a certain height above the soil, are bare and without branches, and therefore there is a considerable space left open between them.\* Plants of the genus *Cereus* are therefore in most general use among the Indians of Mexico for hedges for their fields, and the species most common is small, and has usually from 5 to 6 angles; it is without branches, and attains a height of from 8 ft. to 10 ft., and when old is thickly set with strong spines; but of this species we have, unfortunately, but little knowledge. There are Indian villages, consisting of from 400 to 500 houses, which have each particular pieces of land, of a considerable size, surrounded by such living hedges, planted from 4 ft. to 5 ft. apart. Hedges are seldom seen here of *Pereskia crassicaúlis*. The dry stems of the stronger *Cerei* are used in the mountainous parts of Chile and Peru (where wood does not abound), as timber, in constructing houses, on account of their being light, and therefore easily conveyed from one place to another; and although this timber appears of a spongy structure, yet, according to Pöppig, it forms an excellent article for fuel, and is very much used every where in those places where wood is scarce, and particularly in the neighbourhood of Copiano, where it is in great repute for melting copper. It is also used in St. Domingo for torches; and the young stems of some species, after they have been soaked, and thereby freed of all the cellular tissue, are tied together at the end, and form a very light and elastic cap. The juicy stems form inexhaustible springs for cattle, where water is very scarce. According to Von Martius, the mules are very clever in kicking off pieces of the stems of the large *Cácti* with their hoofs, and then sucking the juice, which flows in abundance. In the high plains of Mexico, immense groups of *Cerei*, *Opúntiæ*, and *Echinocácti* afford the only means of satisfying the thirst of the innumerable herds of wild animals that abound there, when all the springs of water are dried up. The enormous-sized globes of *Echinocáctus íngens*, and the species nearly allied to it, are used by smugglers in Mexico, for concealing their contraband goods, particularly brandy: for this purpose, the inner part of the plant is scooped out, and the empty space filled with the goods or liquors to be concealed; the piece of the rind that was cut out is then carefully replaced, and the plant carried to its place of destination. The slimy juice of the *Cácti* is very much valued by the Indians, on account of its cooling antifebril

\* In the most southern parts of Europe, there are frequently seen long rows of *Opuntias* on the sides of the roads, which are not planted as hedges, but are only allowed to grow on waste places, on account of the fruit.

qualities, and the pulpy matter is used as poultices for softening sores or abscesses; and whole Cacti, or some cut in pieces, are thrown by the natives into dirty water, to purify it.

In Mexico, according to Von Karwinski, the tender shoots of *Opúntia Nopalilio* are eaten as vegetables; and the flesh of *Echinocactus cornigera*, and species nearly allied to it, are cut in slices like pumpkins, and preserved in sugar.

According to Pöppig, the spines of many of the Cerei are used in Peru as knitting-needles.

It is well known that the fruit of many species is eaten, particularly that of several of the *Opúntiæ*. In the south of Europe, the most southern part of Italy, Greece, and Spain, these fruit are a favourite kind of food; and this is found to be the case wherever the *Opúntia* grows wild, or is acclimatised. In Spain, Karwinski informs us that the love of eating this fruit is carried even to a passion. Its time for ripening is in September, when the enjoyment of this fruit is at its height, and which only lasts about a fortnight, on account of the rapid decay of the fruit. Hundreds of venders sit in the streets, stripping this favourite food off the *Opuntias*, with their hands fearfully swollen from pricks of the spines; and they perform the operation with so much dexterity, that it recalls to mind the opening of oysters on the sea coast.

Many admirers of this fruit eat a hundred at a time, and several people die every year in consequence of having partaken too freely of this delicacy. Death from this excess is generally as sudden as that from cholera, and particularly so to those who try to mitigate the complaint by drinking brandy. The fruit of the *Opúntia* is also highly valued as food in Mexico.

The most favourite species in Mexico are the *Alfajayuca*, and the *Tuna de Castilla*. The former has very large branch joints (*Astglieder*), free from spines; and it bears a fruit of the size of a large man's fist, which is almost void of spines, and of a green or yellowish colour. The interior of this fruit has an exceedingly agreeable taste, and a sweet soft flesh. The fruit of the latter, which, according to tradition, was brought from Spain to the colonies, is smaller than that of the cultivated plants of the same species in the mother country, and is furnished with strong spines; its red flesh is also very well tasted. These two species are particularly used for breeding the cochineal insect. The fruit of many of the varieties of *Tuna* and of *O. Nopalilio* is also eaten.

Many of the *Cardones*, that is the high, many-branched, strongly-spined Cerei have edible fruit, one of which, in Mexico, is tolerably large, and of a deep red; the other is black, and only about the size of a cherry; and, on account of its resemblance to the fruit of the *Prúnus Capóllin* (*Cerasus Capóllin* Arb. Brit.), has obtained the name of *Capulin*. The sour berries also of the *Mammillária* are eaten by the Indians, and called *Chilitos*: the diminutive of Chile, the fruit of the Spanish pepper, which they resemble in colour, and somewhat in appearance. The berries of many of the *Peréskiæ*, the so-called *Groseilles d'Amérique*, are likewise eaten in the West Indies; whereas, on the contrary, the fruits of the species of *Echinocacti* and *Rhipsalis* are every where left to the birds.

The use of many kinds of *Opúntiæ* for the cochineal insect is already well known. This useful species is called *Nopal* by the Indians in Mexico, and all the others are known by the names of *Tuna*, or *Tuna brava*.

The *Opúntiæ* and Cerei which grow in very barren places, and in crevices of rocks, are much famed; because their roots penetrate into the smallest chinks which separate stones, and reduce them nearly to powder, and thus with the addition of their own decayed remains, the soil is improved. De Candolle (*Revue*, p. 105.) relates that, at the foot of Mount *Étna*, the old fields of lava are by this means gradually brought to a productive state. Cuttings of *Opúntiæ* are planted in the chinks of the rocks, which thrive well; and produce an abundance of fruit. This is also mentioned in the *Linnæa*, by Dr. Phillipi (*On the Vegetation of Etna*, 1832, p. 739.), with the addition, that there are there innumerable varieties with pale red, dark red, and green fruit,

(Moscarelli), which, on account of their aromatic taste, are much valued, and they are seldom found with fruit without seed.

In the time of the old Mexican kingdom, the Nopal was a plant in great estimation, and almost held sacred on account of the colour, so much used in dying, called cochineal, and was the symbolical sign of the kingdom of Mexico. A branch of the Nopal, on which an eagle sits, with a serpent of coral in its bill, now forms the arms of the republic. (See the Review of Bateman's *Orchidaceæ of Mexico*, &c., in Vol. XIII. p. 509.)

[In our next we shall probably give some farther translations on the subject of *Cactææ*, at present so popular among the patrons and amateurs of gardening in England.]

## ART. II. On grafting *Ipomœas*, and more particularly *Ipomœa Horsfälliæ*. By D. BEATON.

I PRACTISE grafting *ipomœas*, in order to get plants with as little trouble as possible of *Ipomœa Horsfälliæ*, which does not strike roots so readily as some others of this graceful family from cuttings, and laying is not always convenient in ornamental plant stoves. The process of grafting is quite simple, and, to a person versed in the subject, it would be quite sufficient to say that cuttings of *I. Horsfälliæ* were grafted on the spare tubers of *I. insignis*, or on those of any other species in that section; but to the amateur it may be useful to state, that, when the shoots of *I. Horsfälliæ* begin to grow in the spring, and when the eye is just ready to push in a young shoot half an inch long, is the best time for this operation. Then cut the scions with two eyes, the upper one to form the leading shoot, and the lower one to help the union with the tuber; cut the scion or shoot just below the joint, and cut out a slice an inch long on the opposite side to the eye. Then take a young tuber, and cut away a slice to correspond with your graft; fit them close together, and tie them tight with a piece of matting; pot the tuber in as small a pot as you can get it into, using very light soil; set the pot into a hot frame, or merely into the stove, and in a few days the union will be complete, and your plant will go on just the same as if it were on its own roots from the first. A few side tubers can easily be spared from an established plant for this purpose; but for the nurseryman, or where a great number of plants are wanting, the following is the best and shortest way to go to work. At any time during the growing season, take as many cuttings as you want plants, of *I. insignis*, or of the species of *Ipomœa* which Mr. Low of Clapton introduced from the higher parts of the Brazils, which is much harder than the *I. insignis*, and in all respects a better stock for *I. Horsfälliæ* than *I. insignis*. They will strike roots in a fortnight; and in a short time they will form young tubers, like those of young dahlias; then shake them out of the pot, and graft them as above. Or any practised person may take the young points of the current season's growth and insert them in the bottom of the cutting, instead of in the tuber, and they will take just as well; but when this plan is adopted the cuttings ought to be divested of their bottom eyes when first put in, otherwise these eyes will be found troublesome in pushing up and contending with the graft.—*Kingsbury*, March 16. 1839.

We earnestly recommend Mr. Beaton's very excellent article to the attention of every young gardener. *Ipomœa Horsfälliæ* was first raised in England in 1832, at Everton, near Liverpool, by Charles Horsfall, Esq., from seeds received either from Africa or the East Indies; and it was named by Sir W. J. Hooker in compliment to Mrs. Horsfall, and figured in the *Botanical Magazine*, t. 3315. It was afterwards figured in the *Botanist*, No. 31., and in the *Floral Cabinet*, vol. i. p. 61. It is one of the most splendid of climbing plants; and Mr. Beaton has shown how it may be multiplied by hundreds.—*Cond.*

## REVIEWS.

ART. I. *Le Bon Jardinier, Almanach pour l'Année 1839, accompagné d'une Revue Horticole.* By MM. Poiteau et Vilmorin. 18mo, pp. 1064, avec planches gravées. Paris, 1839.

THIS excellent work continues to appear annually, accompanied every year by a review, or register, of the horticultural improvements which have been made in the course of the year, and by notices of the new plants that have been introduced both into horticulture and agriculture. We have in the second volume of this Magazine, p. 58., given a general idea of the plan of the *Bon Jardinier*, accompanied by some abridged extracts; and in subsequent volumes we have noticed the edition of the work for the passing year. The supplementary part of the present volume is enriched by a greater number of plates than usual, and by 34 pages, describing them and other novelties, at which we shall take a hasty glance.

*Brássica sinénsis*, L., the *Pé-tsai* ou *Chou Chinois*, *Chinese Cabbage*.—This, in China, is considered one of the most valuable culinary vegetables, but it does not appear to be much liked in Paris, where it has been cultivated by a number of persons during the last two or three years. The leaves are thin, and more like the leaves of a turnip than those of a cabbage; but they vary greatly in appearance, sometimes resembling a cabbage lettuce, and at others an open borecole. The plants are of rapid growth, and speedily run to seed; so much so, that in China the spring sowing will ripen its seeds in July, from which plants are raised which again ripen seeds in the autumn. It is only in the latter season that the plant heads, or cabbages, like the European sort; but the leaves, being very tender, may be used without being blanched by cabbaging, like those of the common borecole. At Paris, the Chinese cabbage is sown in July or August, transplanted in three or four weeks afterwards, and in two months cabbages will be formed. M. Vilmorin, however, has found that the Chinese cabbage always succeeds best when sown where it is finally to remain. In regard to climate, this cabbage appears to be about as tender as cauliflower or broccoli; and therefore, as a potherb, it is never likely to come into general use either in France or England. Seeds, we observe, are advertised for sale in London at one shilling a packet.

*Sinâpis pekinénsis* Lour., Willd., 2. p. 485., *Chinese Mustard*.—The same missionaries who brought the Chinese cabbage to Paris brought the Chinese mustard. This plant, of which an account has been given in the *Horticultural Transactions*, is grown in the south of China for its leaves, which, when boiled, have a powerful and rather disagreeable odour, much relished, however, by the Chinese. In this country, when the leaves are eaten raw like salad, they taste like those of the common cress, with somewhat of the piquancy of mustard seed. Its growth is as rapid as that of the common mustard. The plant appears to be nearly as hardy, and may be considered as an additional salad plant.

*Convólulus* Batâtas L.—The sweet, or Spanish, potato has ripened seeds in the garden of M. Sagèret, in Paris, from which young plants have been raised. Among these, it is hoped that some will be found hardier than others, and on that account more likely to succeed under open air culture.

*Cichòrium* *Yntybus* L.—A variety of this plant has been obtained from seed, with large leaves, and the heart full, or cabbaged, like that of the garden endive. M. Jacquin obtained this improved variety by sowing and selecting, for several generations; the soil, and other circumstances, being rendered as propitious as possible. The result is interesting; not only on account of the variety produced, but as pointing out the mode in which other improved varieties of wild plants may be obtained. It has always appeared to us as highly probable, that the wild endive and the garden endive were only one species.

*Tropæolum tuberosum* has produced, in the Jardin des Plantes, tubers as large as a hen's egg.



*Medicago sativa* L., the *Lucerne*. — This plant is cultivated in Chile, where it has doubtless been introduced by the Spaniards. It is there called *Alfalfa*; and seeds have lately been sent to France under that name, which was supposed to be that of a new species. Some years ago, Mr. Masters of Canterbury, also, received seeds of the common lucerne, from Chile.

*Trifolium hybridum* L. is a native both of France and Sweden, and has been cultivated in the latter country in artificial pastures for about forty years. M. Vilmorin has lately tried this species in France. He does not consider it as a hybrid between the common red and white clovers, as has been generally supposed, but as a natural species. It resembles more the white clover than the red clover; but, though its stems are recumbent, they do not root into the soil like those of the former species. In short, it appears like a giant white clover, but with flesh-coloured flowers. In Sweden it has been known to grow as high as 5 or 6 feet, and to last for fifteen or twenty years, yielding one mowing every year. It is a perennial, and prefers strong moist soil. It has been introduced into Scotland by Mr. Stephens, a professional drainer, who goes annually to Sweden, and who received a medal from the Highland Society of Scotland for introducing this plant.

*Avèna sativa* L. — The agricultural journals of Flanders have lately been loud in their praise of two new varieties of oat, the one white, *avoine blanche*; and the other black, with the rather singular name of *avoine de trois lunes*, which probably alludes to its quickness in ripening. The white variety, M. Vilmorin says, somewhat resembles the potato oat; and the black promises to be very productive.

*Betterave jaune d'Allemagne* is a new variety of mangold wurzel, which is found to be far superior to any other hitherto in use for fattening cattle. Seeds of this plant, as of all the others mentioned, or to be mentioned, which ripen seeds in Europe, may be obtained of M. Vilmorin.

*Polygonum tinctorium* Loureiro, *Persicaire Indigo, ou Renouée tinctoriale*. — This plant was introduced from Asia in 1837, and has proved to be a valuable accession to the plants used in dyeing. It will doubtless succeed as such in the south of France, but not in the climate of Britain; where, though it may grow during summer, like any other tender annual, the want of bright sunshine will prevent it from arriving at a sufficient degree of perfection, to render its juices of much value as a material for dyeing.

*Paeonia albiflora fista*, raised from a seed of *P. edulis*, has very large double white flowers, sometimes 7 or 8 inches broad, with some of the interior petals tipped with bright carmine red. It is said to be the handsomest of all the peonies, ligneous or herbaceous. A figure of it is given in *L'Herbier de l'Amateur*, and there is a copy of this or some other foreign plate, in Marnock's *Floricultural Magazine* for March, where it is called *P. Makóya*, and where the flower is said to be highly scented, a property not mentioned by M. Poiteau in the *Bon Jardinier*.

*Abies Pinsàpo Boissier, Picea Pinsàpo, Gard. Mag.* — An abstract is given of the article on this fir in the *Bibliothèque Universelle*. See Mr. Lawson's translation of the article, with M. Vilmorin's postscript, p. 109. Since that article appeared, we have obtained a specimen of the pinsapo; and seed may be had of M. Vilmorin or Mr. Charlwood. Some seeds were sent to the Horticultural Society from Geneva, last year; in consequence of which we have introduced it in the *Second Additional Supplement to the Hort. Brit.*

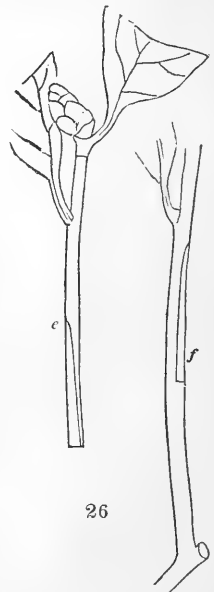
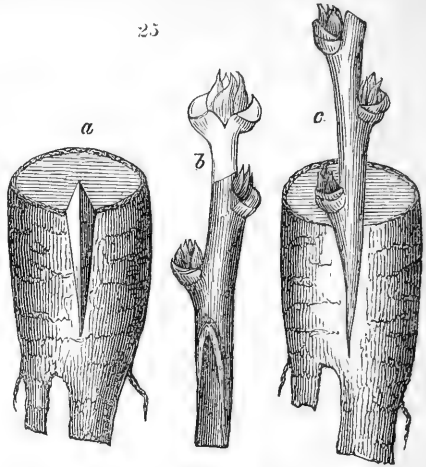
*Pinus pyrenæica* Lapeyrouse, *Pin des Pyrenées*, was described by the late Picot Lapeyrouse in his *Flora of Toulouse*; but it was forgotten till again brought into notice by Capt. Cook, in his *Sketches in Spain*. M. Vilmorin's attention being directed to this species, he succeeded in procuring seeds. He finds, as Capt. Cook had stated, that the tree does not grow on the French side of the Pyrenees, but on the south side; and that whole forests, in the province of Arragon, consist almost solely of this species. "The branches and the cones," continues M. Vilmorin, "which have been sent to me" by M. Paul Boileau of Bagnères de Luchon, bear a very great resemblance to those

of *P. Laricio*; the cones being only a little larger, and of a lighter colour. Notwithstanding that difference, I was near regarding these two trees as identical; but the young plants raised from the seeds of *P. pyrenæica* have induced me to alter that opinion; they differ sensibly from those of *P. Laricio*, but bear a certain resemblance to those of *P. maritima*. It becomes, then, very probable, that the *P. pyrenæica* is at least a very decided variety of *P. Laricio*. I suspect that it will be found identical with the Calabrian pine [*P. L. calábrica Art. Brit.*]. At all events, it is evidently an interesting tree to study, and to follow up."

*Multiplying Tree Peonies by grafting.*—Plants of the *Pæonia Moultan*, raised by cuttings, remain weak for several years; but those grafted on the tubers of

the herbaceous peony grow with vigour, and, if permitted, will flower the following spring. The operation of grafting is performed between July 13. and August 13., and will readily be understood by *fig. 25.*, in which *a* represents a triangular section made in the tube or stock; *b*, the scion, the lower end of which is pared off, so as to fit the triangular cavity in the stock; and *c*, the scion fitted to the stock. It is not necessary that there should be more than one bud on the scion; and, if a blossom bud should be chosen, it will flower vigorously the following spring. In two or three years the scion will throw out roots, and become independent of the stock. This mode of propagating was invented by M. Soulange Bodin, who, after grafting, places the plant in a pot, plunges it in heat, and covers it with a bell-glass. By September the scion has united itself to the stock; and in October, the stock throws out roots, and the plant may be removed to a green-house or frame. Mr. Masters of Canterbury has adopted this mode of propagating, with this difference, that, after grafting, the graft being tied with bast, and covered with grafting-wax, the whole is inserted into a bed of tan, leaving only about half an inch of the point of the scion above the surface. The grafted plants are inserted in the angular interstices between the pots, with which the pit is usually occupied; two, three, or four, are placed together, according to the size of the triangular space; and a larger or smaller bell-glass is placed over them, as may be requisite. The tubers throw out roots by the end of September, or the beginning of October, and are then taken up and potted, and placed in a cold-frame, where they remain through the winter.

The grafting-wax used for covering this graft is composed as follows:—Burgundy pitch, 1 lb.; black pitch, 4 oz.; rosin, 2 oz.; yellow wax, 2 oz.

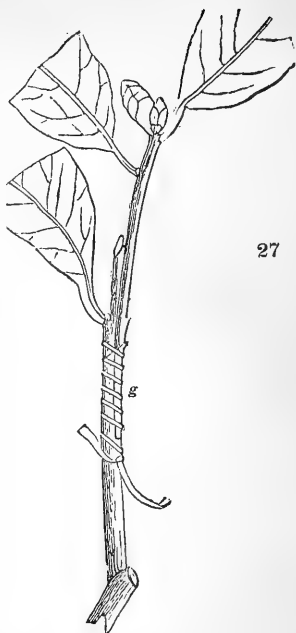


tallow, or suet,  $1\frac{1}{2}$  oz. The whole-melted together, and, after being stirred, and allowed to cool, it is used when rather less than milk-warm.

The tree peony may also be grafted with perfect success by using the shoots of the current year in the month of April as scions, and grafting them on the tubers of the herbaceous peony of the last year.

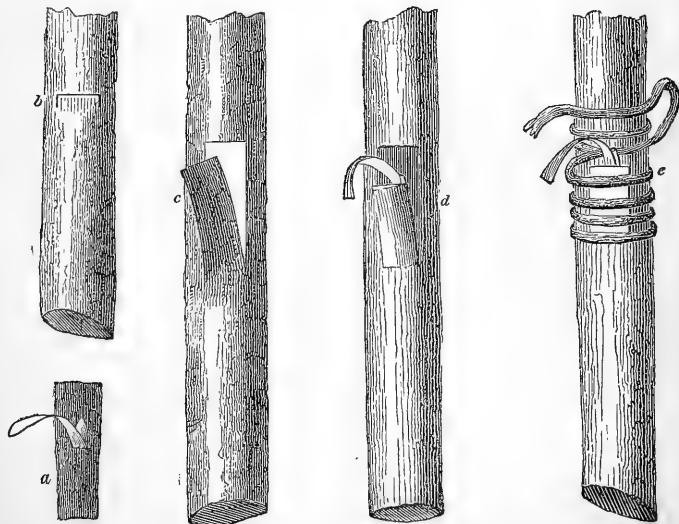
*Veneer-Grafting, Greffe en Placage.*—The scion, which may either contain one or several buds or leaves, is cut like the mouth-piece of a French flute elongated, as in *fig. 26. e*; the stock is prepared to receive it, as at *f*; and, when the scion and stock are united, the appearance is as in *fig. 27. g*. The graft should not be tied with worsted threads as is usually done, but with untwisted linen or cotton thread; and the whole should be afterwards covered with grafting-wax, and then plunged in heat, and closely covered with a bell-glass (*étouffé sous une cloche*), in M. S. Bodin's manner, till it has begun to grow. This mode of grafting is practised with great success by M. Camuset, head gardener in the Jardin des Plantes.

*A Mode of budding which unites to the usual Chance of budding, that of Flute-Grafting* [described in the *Gardener's Magazine*, vol. v. p. 425.] The bud is prepared in the usual manner, except that both ends of the shield are cut square across, as in *fig. 28. a*. On the stock the bark is cut horizontally and vertically



27

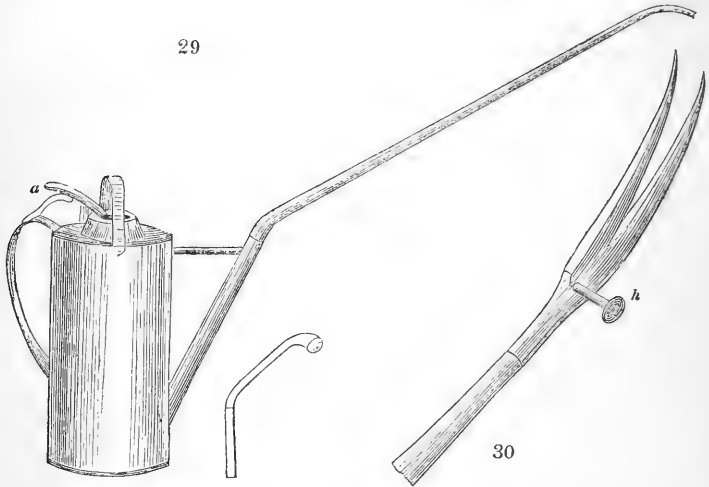
28



to a very small extent, as indicated at *b*. This being done, the right hand of the operator applies the thin flat point, or spatula, of the handle of

the grafting-knife on one side of the incision, and passes it through to the other side; the strap of bark is then torn down, as shown at *c*, the thumb being placed on the upper part of it, so as to hold it firm against the blade of the grafting-knife; while with the left hand, the bud or shield is inserted in its place. This being done, the shield is cut across, so as to fit exactly to the bark of the stock at its upper part; and, next, a portion is cut off the raised bark, so as to reduce it to such a length as will bring it exactly up to the lower side of the bud, as shown at *d*. The bud is then tied, as shown at *e*; but with the petiole of a leaf included in the upper part of the tie, the leaf suspended from which serves to shade the bud from the sun.

By this mode of grafting, the soft wood is less injured than by the common mode, in which it is always more or less scratched by the blade of the budding-



knife, and is sometimes removed altogether; when, of course, the bud has no chance of success. This graft is particularly adapted for thin-barked plants, and more especially for roses. It appears to us to be a very decided improvement on the common mode of budding, and we hope it will be generally tried by British gardeners.

*A Sucker Watering-pot*, uniting the aquarium of Mr. Murray (figured in our Vol. VII. p. 219.) with the common long-spouted watering-pot used in hot-houses, is described as being well adapted by its spring valve (*a*, in *fig. 29.*) for watering plants in pots which are at a considerable distance from the operator.

*The continuous Syringe* (Ardo-pompe, ou Pompe continué), said to be invented by M. Petit, differs little, if at all, from Reid's new hydraulic engine, figured in our Vol. XIII. p. 459.

*The Volant* is a small hand-scythe, or rather sickle (*fig. 31.*), used in mowing lawns; for the purpose of cutting grass at the roots of trees and bushes, where the common scythe is too cumbrous an instrument.



The *Extirpateur Courval* (fig. 30.) differs from an instrument of the same kind which has long been in use, both in Scotland and England, for rooting up docks and thistles, chiefly in having the knob, *h*, instead of a piece of iron rivetted on in the form of an inverted arch, as shown in the weed-extirpator, fig. 327., in the *Encyc. of Gard.*, edit. 1835, p. 520.

The *Meridien à Canon* is a small lens for the purpose of igniting gunpowder, and producing a report at any particular hour of the day, during sunshine. It is commonly set to indicate mid-day. The inventor is M. Arnheiter, who sells it at a very low price.

*Hot-houses.*—Several plans and sections of these are given; but, as there is nothing in them that is not already familiar to the English reader, we pass on to

The *Heating of Hot-houses.*—The forcing-house at Versailles is heated by hot water on the siphon principle, which is explained in detail; and an idea is also given, by an engraving, of the mode adopted at Messrs. Loddiges's. The hot-house brazier used by M. Fion is employed to burn charcoal, and may be considered as differing chiefly from Joyce's stove in being a great deal cheaper.

The *Tool-shed*, of which an engraving is given, is one of the most awkward contrivances for holding tools that we have ever seen. Let the reader imagine a music-stand placed against a wall, with a roof over it, and the handles of the hoes and rakes projecting out on every side, and exposed to the weather, while the blades only are protected, by resting on the shelves.

A *Stage for preserving Grapes* is a frame 7 ft. high, 7 or 8 feet long, and about 3 ft. wide; one end is open; the other, the sides, and the top, are filled in with rails or bars, from which the bunches of grapes are suspended.

The remaining part of the *Nouveautés*, or annual supplement, consists of a Report (favourable) on *L'Herbier générale de l'Amateur*, a work with coloured plates of ornamental plants; the contents of the *Revue Horticole*; and an announcement of the *Catalogue* which is to be published by the Horticultural Establishment of the Boulevard Mount Parnassus.

An Essay on Manures, in which the theory of their action on plants, and the principal means of obtaining the greatest benefit from them, by M. Payen, is the next article; in which the great superiority of animal manures over those of the vegetable kingdom is conspicuously pointed out.

Such are the contents of the first 92 pages of the *Bon Jardinier*. What may be called the permanent work commences with a monthly calendar; then follow prognostics of the weather; next, the general principles of gardening, including an account of the implements used, and of the operations to be performed, much in the same order as in the *Encyclopædia of Gardening*; after this, culinary vegetables are treated of in alphabetical order; then medicinal plants; then agricultural plants; then fruit trees; then ornamental trees; roses, with a list of the principal French dealers in these shrubs; next follows a list of the most interesting plants cultivated in gardens, arranged according to the order of their employment; and the work concludes with a vocabulary of terms used in botany and gardening, including, under the head *Méthode Botanique*, keys to the systems of Linnæus and Jussieu.

Our readers will thus see that the *Bon Jardinier* is a truly valuable work, not only to French gardeners and amateurs, to whom it must be indispensable, but to the gardeners and amateurs of other countries, who wish to understand French gardening, or French books on the subject; or to possess the new plants or new implements introduced into French gardening or French agriculture.

The *Nouveautés* of the *Bon Jardinier*, for 1838, are chiefly plants new to Paris, but all of which are already well known in this country. M. Vilmorin gives an account of his success in civilising, if the expression may be used, the wild carrot. In three generations he brought it, from a little hard cord-like root, to a tender fleshy cone, sweet, and of good flavour, such as we now find

it in gardens. M. Vilmorin is now occupied in civilising the wild cabbage; and he recommends to other amateurs the perennial lettuce (*Lactuca perennis L.*), as worthy of being improved, and rendered an object of culture as a culinary vegetable. A verge-cutting plough is figured and described, which is said to be used with success by M. Jacques, gardener to the king, at Neuilly. It might perhaps be useful in England, for cutting the verges of public roads; but we think it would leave a very deep, ugly, raw edge in garden scenery. The French are not nearly so particular with their edges and walks as we are. The wheel verge-cutter, figured in our second volume, p. 66., and here repeated (*fig. 32.*), is a very superior instrument, well meriting introduction into England, because it may be employed so as to cut the leaves of grass, without paring off any of the soil.

A new planting-instrument, as a substitute for the dibber, is described and figured, formed on the plan of the old transplanter for florists' flowers, but we do not think it is likely to be of much use. It may truly be said, that, in the multiplicity of garden and agricultural instruments, there is no end.

The *Nouveautés* of the *Bon Jardinier* for 1837 include various curious implements and contrivances; the greater part of them, we are informed in a note, were taken from London to Paris by M. Audot, the publisher of the *Bon Jardinier*, who pays occasional visits to this country.

The *Nouveautés* of the *Bon Jardinier*, for 1836, comprise various designs for the jets of artificial fountains, which are manufactured by M. Dugast, Rue Sainte Marguerite, No. 54., Faubourg St. Antoine. The ajutages are contrived to form the following figures: a tulip, corbeille (basket), candelabrum, moulinet (wind-mill), berceau (cradle), panache (plume of feathers), &c.

The "*Additions et Corrections*" to the *Bon Jardinier*, for 1835, also contain some designs for ajutages to fountains. Those of which engravings are given are entitled: l'éventail (the fan), la gerbe (the sheaf), la tulipe (different from that figured in the *Bon Jardinier* for 1836), la coupe (the cupola), la double girandolle, le miroir, la boule entière (ball), and le Chinois. As fountains are becoming fashionable in England, we have thought it might be useful to refer to these figures, and to give the name and address of the maker.



32

---

ART. II. *Annales des Sciences Physiques et Naturelles d'Agriculture et d'Industrie*. Publié par la Société Royale d'Agriculture, &c., de Lyon. 4to. Tom. I. Livraisons 1, 2, et 3., pp. 346., plates and folding tables, meteorological and exhibiting agricultural book-keeping. Lyons, 1838.

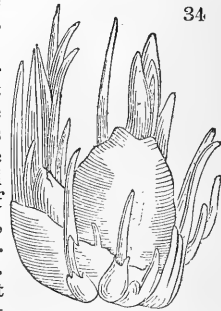
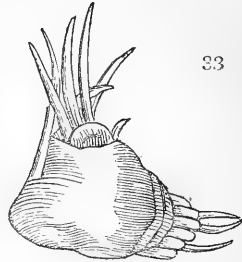
THIS is one of the most respectable works of the kind published in France, whether we regard the matter, or the appearance of the publication. There are several papers in the three parts now before us, of a highly scientific, and yet practical, character, which would be well worth translating and publishing in an English agricultural journal; and there are others, which we should translate for the *Gardener's Magazine*, if we could find room.

The first article treats of the physical geography and the geology of that part of France to which the Society confines its exertions, viz., the Department of the Rhone; an excellent idea, carried into execution in a superior manner, and illustrated by maps, diagrams, and weather tables. An article on bulbous plants, by M. Seringe, shows how they may be propagated by cutting over the bulb or bud a few lines above the plate, which

forms the point of union of the stem or leaves and the root. The upper surface of the plate being, in fact, the stem not developed, or but very partially so. The scales of the bulbs are rudimentary leaves, and in the axils of these, as in those of real leaves, there are dormant buds, which cutting over these scales or leaves calls into action. Sometimes even the frost destroying the outer scales of a bulb will stimulate the buds in the inner part to develop; and sometimes, when the scales are very closely compressed at top, the buds in their axils will develop, and protrude below. M. Seringe illustrates his general position by referring to a plant of *Crinum canaliculatum* in the Botanical Garden at Lyons, which, being cut over a little above the

plate, threw out no fewer than forty offsets; and he has given two figures (figs. 33. and 34.), the one to show a hyacinth bulb protruding offsets, in consequence of the outer scales being destroyed by frost; and the other to show buds developing horizontally, in consequence of the scale being compressed above. Passing over a paper on the vine, we come to one on the choice of a rotation, and the employment of manure, followed by a new mode of agricultural book-keeping; an excellent paper. One of the maxims of this writer is, that "there can be no good agriculture without abundance

of forage obtained or grown cheap, and sold dear in the form of cattle." "Next to a good plough and a good harrow, the best machine for the farmer is the dung machine called an ox." At a meeting of the Society, held on the 9th of February, 1838, the idea of cultivating *Ænothèra biennis*, for the sake of its roots, which are fleshy, mild, and nutritive, was suggested. This has already been done in England, but by no means to a sufficient extent. We do not see why the roots of this plant should not be grown to as large a size as those of the carrot or parsnep; we have tasted them dug up from the flower border, and found them much more agreeable than the root of the carrot in a wild state. The carrot has been civilised, so to speak, by M. Vilmorin, in three generations. (See our notice of the *Bon Jard.* for 1838, in p. 167. The same member remarked of the artichoke, that it was known as an edible plant by the Romans, but forgotten or disdained during the dark ages, till it came into notice again in the 16th century. Almost all the parts of this plant, he says, may be rendered useful. From the leaves an extract may be obtained, which will serve as a substitute for quinine. The leaves may be cooked and eaten after the fruit is gathered, or used as fodder, and mixed with certain grasses; they may be substituted for hops in making beer; and they contain a great quantity of potash. At this meeting, in noticing the injuries done to the vine, it was affirmed by some that the lizard eats the grapes, and ought to be destroyed; by others, that it did not touch the grapes, but only devoured the worms and insects, and ought to be preserved. Notice was taken of the injury done to garden plants by the preceding winter, which appears to have been as great at Lyons as at London. *Laurus nobilis*, *Laurocérusus*, the Portugal laurel, the aucuba, the alaternus the phillyrea, roses, and hollies having been either killed or greatly injured, particularly in the nurseries situated near the Rhone. The common box was also injured, but the Majorca box not in the least; nor the single hibiscus, nor the Scotch and Weymouth pines. Apricots were killed in a great many places; and the shoots of the past year, of almost all trees, whether indigenous or foreign, were more or less injured. At a meeting of the 16th of February, 1838, the subject of the preceding winter was again discussed, when it was



Vol. XV. — No. 109.

stated that grounds sloping to the west suffered less than those exposed to the south and east; and that elevated situations suffered much less than the plains. Insects were not destroyed, and only some of them slightly injured.

An article on *Oxalis Dépei*, by M. Hénon, describes the plant as at once ornamental and useful; the leaves forming a good substitute for those of the common sorrel. The plant, according to this author, has not been correctly figured, either by Loddiges or Sweet; and it is still worse delineated in *Les Annales de Flore et de Pomone*, for 1834-5. A very elegant figure in outline, with various dissections, illustrate this paper.

The most interesting article in the three livraisons before us is, a Report on the Gardens and Nurseries in and about Lyons, by a committee appointed for that purpose; but this we have made the subject of a separate article, in a preceding page.

At a meeting held Feb. 16, 1838, M. Seringe, a botanist whose name often occurs in De Candolle's *Prodromus*, read a memoir on the advantage of pruning the mulberry at the same time that the leaves were gathered from it, in which he argued, from physiological considerations, that this would produce a handsomer and a longer-lived tree, and a greater return of leaves.

March 9. The purple laburnum was the subject of discussion. It was supposed to have been raised from seed in 1828; a mistake, as will be seen by our *Arboricultural Notices*, p. 122.; and M. Seringe, M. Hamon, curator of the Botanic Garden, and M. Hénon, secretary to the Society, expressed doubts as to whether the appearance of the purple cytisus on this supposed hybrid was not effected by some trick.

March 30. Notwithstanding the immense quantity of mushrooms brought to market at Lyons, the supply is not sufficient for the demand, and they are brought from Paris, where they cost one franc a pound, and the carriage amounts to another franc. M. Chaîne, the only market-gardener in Lyons that ever grew mushrooms, and whose cellars and forcing-houses produce them every day in the year, has this season, up to this date (March 30.), sold early radishes to the amount of 12,000 francs. Such is the effect of commercial prosperity upon horticulture. (p. 241.) The silver medal was adjudged to M. Chaîne, for having been the first to cultivate the mushroom at Lyons. The founder of the Society, in 1761, l'Abbé Rosier, proscribed the use of mushrooms, on account of the accidents which sometimes happened to those who ate them.

At the exhibitions of the 24th, 25th, 26th, and 27th of May, 1838, a great many rare and handsome plants were brought forward by about forty individuals. The majority of the plants were in pots or boxes, from the hot-house, green-house, or pits; but there were also many cut flowers, and branches of hardy plants. At this exhibition there were also various implements of horticulture and agriculture; and among these were included figures in copper, or in sheet-iron, and painted in oil in imitation of nature. *Calla æthiópica* and *Agave* were so well executed, that a "very great number" of the spectators took them for living plants. Imitations of this kind, more particularly of the *Agave*, are common in Italy, where they are put in vases on the piers of gates, parapet walls, &c. An instrument named "une approche" was exhibited by M. Guillermin, the use of which is to hold together two branches that are to be grafted by approach. Rustic tables and flower-stands were also exhibited. The number of articles in all, plants included, were about 1,500, of which 200 belonged to amateurs. Of the plants supplied by commercial gardeners, 517 were purchased by the Society, and put into 362 lots, represented by an equal number of tickets, which tickets were purchased, and the plants drawn for in the manner of a lottery. Every lady, as she entered the exhibition room, was presented with a nosegay. A *Memoir sur les Fruits de Géraniacæ*, by M. Seringe, contains some curious matter respecting the monstrosities which occur in the geranium, &c.

We have passed over a number of other papers, relating to geology, the vine, the silkworm, and agriculture, as being unsuitable for this magazine.



ART. III. *Die Vier Hauptfeinde der Obstgärten, &c. The Four principal Enemies of the Orchard, with the most effective Means for their Destruction.* By Vincent Kollar, Keeper of the Imperial Cabinet of Natural History. Pamph. 8vo, pp. 30. Vienna, 1839.

THE following is a translation of the Introduction to this pamphlet, which is entitled "From what do caterpillars arise, and what becomes of them?"

The melancholy appearance of the orchards in the neighbourhood of Vienna, and the serious complaints, from all quarters, of the great destruction which the caterpillars have effected on all kinds of fruit trees, have induced me, in the following pages, to give some short instructions to countrymen and gardeners, which will, in most cases, enable them to protect their fruit trees from similar devastations.

There are, it is true, many books, and many treatises in the different periodicals on domestic economy, which have already treated this subject in a masterly manner; but these works are either out of print, or, from the number of years which had passed away without any particular injuries having been effected by the caterpillars, have been entirely forgotten. Many of these books are also much too expensive for the countryman.

When we contemplate an orchard devastated by caterpillars, such as the orchards near Vienna were in the past year (and, according to all appearances, the following year will be much the same), one might almost believe that one of the plagues of Egypt had come upon us, and that all kinds of insects had sworn death to the different varieties of fruit trees; and yet in such years it is generally observed that only one kind of caterpillar destructive to fruit trees commits the devastation.

There are seldom more than four different kinds of such caterpillars in the same summer; and they appear at different periods. It must, however, be observed, that the different kinds of destructive caterpillars do not all appear at the same time, but come in succession; so that the devastation of the fruit trees is sometimes finished by the second, third, or fourth kind of caterpillar, which was begun by the first.

From my own experience, and also from the observations communicated to me by my friends, I am enabled to ascertain that there were only four kinds of caterpillars which, this year, in Austria, and also in the adjacent countries, not only stripped the fruit trees of their leaves, but, in great part, stripped them also of their fruit.

I do not mean to say that the four here treated of are always those that are most destructive to fruit trees; there are, on the contrary, a great many more, quite as injurious; but whoever wishes to know more of those insects may consult my work on that subject, entitled *An Account of the Insects injurious to the Farmer, Gardener, and Forester*; Vienna, 1837\*; which I wrote by the desire of the Imperial Agricultural Society of Vienna, and in which the chapter on the insects injurious to fruit trees is most skilfully handled by one of our greatest pomologists, M. Joseph Schmidberger, canon regular of the Institution of St. Florian. This pamphlet may therefore be considered as an extract from that large work, and will only treat of those insects that are the most destructive to fruit trees.

But whoever expects to find in that work warranted receipts for the annihilation of insects will be very much mistaken; and, probably, displeased with having made the purchase, may throw down the book without reading it; but these persons may believe me, when I say that such receipts, though valued by some, are only catchpennies; and, not to mention the loss of time and money which they occasion, are of no benefit to the fruit trees, but, in many cases, even do them an injury. For example, syringing the trees with ley, dis-

---

\* This work has been translated by a member of our family, and will appear early in April.

solved common salt, or chalk ; fumigating them with brimstone, tobacco, &c. ; with all of which time is lost, and nothing useful gained.

What, then, are the means of destruction which the gardener or amateur is to be made acquainted with ? No other than teaching him how to know the enemy of his orchard, in the different stages of its existence ; so that in summer, when the trees are clothed with verdure, as well as in winter, when they are deprived of their green covering, the enemy may be detected ; and also in spring, when it has already undergone a change, and when, while feeding rapaciously on its booty, it may be combated with the least loss of time.

There are a great many people who do not actually know what the worms or caterpillars are which strip the trees of their leaves, and also who do not know what they arise from, or what at last becomes of them, because they disappear without being seen in a dying state.

To those, therefore, who are not acquainted with the nature of these worm-like appearances, I submit the following observations for their instruction.

All caterpillars, or worms (as they are improperly called by country people), proceed from small eggs which moths and butterflies lay, sometimes on the leaves, branches, or bark, of trees, at different times of the year. The number of caterpillars, therefore, depends on the number of butterflies, to which they owe their existence : thus, if we had no butterflies, we should have no caterpillars to dread ; and if we could destroy the butterflies before they laid their eggs, no caterpillars would make their appearance.

From what has just been said, it may be seen that, if you wish to protect your fruit-trees from the caterpillar, you must begin by destroying the butterfly.

All butterflies, or rather all their caterpillars, are not equally injurious ; many of them feed on other plants besides fruit-trees, and even on weeds ; it is therefore not worth the trouble to catch the butterflies that do so little injury ; and thus, as it is necessary to know the appearance of those butterflies which produce the most destructive caterpillars, I will give a full description of each, when describing the caterpillars to which they belong.

To destroy the enemies of our orchards, therefore, we must begin with the destruction of the butterflies found in them. Butterflies are furnished with wings, and, therefore, easily can escape our pursuit ; and we know what trouble it gives an active and light-footed boy to catch one with his net. I, therefore, by no means recommend the pursuit of butterflies, particularly as they have enemies which are sure of capturing them. I mean birds of all kinds ; which, although they may despise large hairy caterpillars, eagerly pounce on butterflies for food for themselves and their young. Instead, therefore, of frightening birds out of a garden, they ought to be encouraged ; and particular care should be taken to induce them to build in orchards, because they destroy an endless number of insects, and butterflies in particular, which are their favourite food, and which are necessary to them for the support of their young.

The gardener can also give great assistance in destroying butterflies. They consist of males and females, and in general the male only is disposed for flight, and flutters from one flower to another ; while the female sits at rest, and seems only to have the wish of fulfilling the chief object of her existence ; viz., that of depositing her eggs. The fluttering males, therefore, may be let alone, and the females only sought for, and destroyed. As the females generally vary in size and colour from the males, this peculiarity, and their places of resort, shall be particularly attended to in my description of them.

We now know that caterpillars proceed from eggs which are laid by butterflies or moths. Is it not, then, possible to destroy the eggs, and by this means to check the evil in the bud ? Certainly, in many cases this is quite possible : but, in the first place, we must know the appearance of the eggs of those butterflies that do so much mischief ; also, where they are concealed, and at what time of the year we ought to look for them ; all of which shall be explained when treating of the different caterpillars.

In the meantime I will only make the general observation, that although the eggs of moths are, in general, very small, yet, when the places are known where

they are usually laid, they can be found out with very little trouble ; particularly as they are not laid singly, but are mostly found in large or small heaps.

As to the length of time the egg remains in that state, it may only be observed, that it is very various, according to the kind of butterfly or moth. Many kinds lie only a few weeks before the young caterpillar makes its appearance, while others lie for months, and sustain the severest cold before they are hatched. At all events, the eggs remain sufficiently long to enable any one to destroy them without much loss of time, after the knowledge necessary for doing so is obtained.

It now remains to show what becomes of the caterpillar when it has attained its full growth ; whether it immediately changes to a butterfly, or whether it passes any length of time in an intermediate state.

The duration of the caterpillar, like that of the egg, is very various. There are caterpillars which remain many months in a worm-like form, while there are others that undergo a change in the space of a few weeks ; and the longer the period of their caterpillar state lasts, the more injury, of course, is done to the trees on the leaves of which they feed. Many caterpillars which are hatched at the end of summer feed during the autumn on the trees, and then enclose themselves in a nest of their own making, lie dormant during the winter, and awaken in spring when the young leaf and blossom buds make their appearance, to recommence their operations, which in a few weeks, nay even days, effect the devastation in gardens which we have witnessed through large extents of country. The rapacity of many caterpillars is so great, that a single one will consume leaves several times the weight of its own body in twenty-four hours ; and it is only in that way that the rapid and total disappearance of the leaves from trees can be accounted for.

Changing the skin is peculiar to caterpillars. Every caterpillar during its worm-like appearance casts its outer skin several times ; and many of them vary their colours at the different periods of changing, so that, all of a sudden, apparently quite a different insect is seen on the trees, and nobody can explain how it comes there. This changing the skin continues till they are fully grown ; and, when they have changed it for the last time, they appear in a form totally different from their former state. They lose their feet, their bodies become shorter, but thicker ; and frequently they are enveloped in a silky web, or suspended by means of one or more threads from the branches of trees, or attached to their trunks, or to walls or hedges. This form of the caterpillar is called a pupa.

During pupation, nourishment is no longer wanted ; and, therefore, when the insect enters this state, we observe a sudden cessation of the devastation of our fruit trees. The caterpillars disappear, without our being aware where they are gone to, unless we are familiar with their metamorphoses. The state of pupation lasts, according to the kind of insect, a few weeks, a few months, or even a few years. The butterfly at last emerges from the pupa, which, as it only sips sweets from the flowers, does no more injury to the trees than the pupa ; but it leaves a new succession of caterpillars in our gardens, as we have already mentioned, that do the injury.

I have observed that, almost everywhere, the picking off of the insects ceases as soon as the caterpillars disappear, although the branches and stems of the trees may be thickly covered with pupæ, into which the caterpillars have been transformed. This neglect, which in the following year is punished by the repeated failure of the crop, is only occasioned by the want of knowledge of the history of the caterpillar ; because, if it were known that the motionless pupæ on the stems and branches are the caterpillars transformed, they would certainly be taken down, as it is much easier to do so, than to destroy the living caterpillars which are crawling all over the tree.

The pupæ, besides, are a very agreeable food for many kinds of poultry, and particularly for pigs.

As I have now given a general idea of the origin of the caterpillar, its growth, and what at last becomes of it, I will proceed to the description of

the different stages of those which, in general, are the most destructive to the orchard, and by pointing out the times in which they appear under various forms, and the places they inhabit, the countryman or gardener will be enabled in most cases to keep his orchard free from such injurious insects with little trouble.

[The insects alluded to are, 1. *Papilio crataegi* Linn.; 2. *Bombyx chryso-rhœa* Linn.; 3. *Bombyx Neustria* Linn.; 4. *Bombyx dispar* Linn.: but, as the descriptions of them given are only extracts from the work already alluded to, and as that work will so soon be published, we do not think it necessary to give them here.]

ART. IV. *Catalogue of Works on Gardening, Agriculture, Botany, Rural Architecture, &c., lately published, with some Account of those considered the more interesting.*

BRITISH.

*VEGETABLE Organography; or, an Analytical Description of the Organs of Plants.* By M. Aug. P. De Candolle, &c. Translated by Boughton Kingdom. In monthly parts, 8vo. 2s. 6d. each. Parts I. and II., February and March, contain 99 pages of letterpress, and 5 octavo plates. London, 1839.

The translator, in his address, truly observes that it has been a subject of surprise and regret, that no edition of De Candolle's elementary works has appeared in an English dress. This desideratum it is his intention to supply; commencing with *Vegetable Organography*, which he expects to complete in 16 parts, at 2s. 6d. each, forming two handsome 8vo volumes; and next translating De Candolle's *Vegetable Physiology*. The intention is most laudable, and we do most ardently hope that Mr. Kingdom may receive such encouragement as may induce him to proceed till he has completed both works. One thing only we have to suggest to him; viz., that he ought to introduce notes, either of his own, or those of some other competent botanist, so as to bring down each particular subject to the present time. We most strongly recommend the work to all our readers who have a taste for plants, and more especially to all young gardeners.

*Catalogue of the British Natural Orders and Genera*, arranged according to the System of De Candolle (extracted from Dr. D. C. Macreight's "Manual of British Botany," London, 1837). Together with the whole of the Linnean Classes and Orders (from Sir W. J. Hooker's British Flora, 4th edition, 1838). Intended to serve as Labels for arranging British Collections, either according to the Natural or Artificial Systems. Printed by Order of the Council of the Botanical Society of London, November, 1838. Arranged under the Superintendence of Daniel Cooper, A.L.S., Curator, &c. London, Longman and Co. 1s.

A useful sheet to those forming herbariums of British plants; and it will also aid the gardener in forming living collections.

*The Amateur Florist's Assistant in the Selection and Cultivation of Popular Annuals; to which is added a Descriptive Catalogue of the more interesting tender Perennials used in decorating the Parterre, and a copious List of European ornamental Alpine Plants.* By George Willmot. Printed for the Author, and to be had at the Nursery, Lewisham. London, 12mo, pp. 76. Edinburgh, 1839.

The author of this work is the son of the late Mr. Willmot, the highly respectable nurseryman and seedsman of Lewisham. The work was composed in Edinburgh, while the author was apprenticed to our esteemed correspondent Mr. Lawson, and is highly creditable to him. The following extract from the preface shows what the reader is to expect in this small, closely printed, cheap, and most useful volume.

“The professional gardener and practical floriculturist are alike cautioned against expecting much more information from the following pages than, it is presumed, they already possess. The intentions of the author are more humble; but he fondly trusts his exertions will not prove the less useful, his principal aim being to convey, in a comprehensive and cheap form, such a portion of that knowledge those already possess, as will enable the villa proprietor, cottager, and small garden occupier, to cultivate for their own recreation the popular annuals, a tribe of flowers surpassed by no others in the vegetable kingdom, for fragrance, diversity of form, or beauty and variety of colouring properties, which are enhanced by the facility with which they may be grown, and the speedy return they yield to the careful cultivator; for, while they may be procured for a trifling amount, they at the same time require less attention than their more permanent congeners; and, instead of waiting seasons, the owner is rewarded for the little requisite attention bestowed on them in a few weeks; a period not only short, but rendered still more so by the pleasure experienced in daily beholding and contemplating their rapid progress, from the time their embryo leaves first appear, to that stage of existence when the profusion and loveliness of their bloom is sufficient to arrest attention, and call forth the admiration of the most careless observer of nature’s beauties.” (Pref.)

*The Bouquet, or Ladies’ Flower-Garden, being a Description of those Plants which will flower in the Room, and the Treatment most suitable for them.* By a Florist. Small 8vo, pp. 102. London, 1839.

A very good little work, so far as it goes.

*A Treatise on the Growth of Cucumbers and Melons, conjointly with that of Asparagus, Mushrooms, Rhubarb, &c.* By John Smith, upwards of twenty-four years Gardener to D. Alexander, Esq., of Ipswich. 4th edition, improved and enlarged. Small 8vo, pp. 93. London, 1839.

An improved edition of a work which we strongly recommended in a former volume.

*A Practical Treatise on the Culture of the Melon.* By John Duncan, Gardener to Thomas Daniels, Esq., President of the Horticultural Society of Bristol, 1839. 8vo, pp. 110. London, 1839.

The following extract from the introduction to this little volume shows the author’s intention in producing it; and we are much mistaken if this passage does not lead to its purchase by all young men and amateurs desirous of bringing that excellent fruit, the melon, to a high degree of perfection. What we particularly admire in Mr. Duncan’s system is its definiteness. He seems, in short, to have done that for the melon which Mr. Hoare has done for the grape. (See Vol. XI. p. 674.)

“I purpose directing the attention of the reader to a very simple and efficient method of forming the fruiting-bed, upon the principle of moderating and retaining its heat to a period much longer than is possible in any other way. I intend also to show the impropriety of having no determinate method in the part of *thinning* and *stopping* the plants; as well as to prove it essential, that a greater quantity of mould than is generally used is absolutely necessary for the support and welfare of the plants, and ultimate perfection of the fruit. From a deficiency in this last particular, arise some of the most fatal diseases and total failures, as the roots, through this cause, too soon absorb the nutriment contained in the little quantity of soil afforded; and then, proceeding in search of it, pass through into the dung, deriving from thence the nourishment which ought to be contained in the soil, and which, by its crudeness and unwholesome nature, induces disease. The sap vessels become engorged with a juice of too rich a nature, evidencing itself by the deep green of the leaves, and the luxuriant appearance of the plants, so long as the process can be carried on; but a short time gives proof that it is too laborious to be continued;

the juices are returned improperly elaborated, laying the foundation of disease of several kinds; insects become numerous, and the plants become so enfeebled as to render their efforts to ripen their fruit entirely abortive." (p. 16.)

*Proceedings of the Linnæan Society of London.* Session 1838-9. No. I. 8vo, pp. 8.

We are glad to see this venerable Society following the example of its younger brethren, in publishing abridged notices of their proceedings at short intervals; viz., whenever they will fill half a sheet, or a sheet. This practice cannot fail to benefit the Society, by giving the public a greater interest in it; to diffuse correct views instead of erroneous ones, which is often done by the newspapers and periodicals, in consequence of the reporters not understanding the subject; and it will gratify the authors of papers, by their seeing them early noticed, instead of being, perhaps, passed over altogether, or only appearing in the Society's *Transactions*, at a distant period.

*Ergotætea abortans* Queck. *The Ergot*.—The number before us contains an abstract from a paper on the cause of ergot, by Mr. John Smith, A.L.S., of the Royal Botanic Garden, Kew; and another on the same subject, by E. J. Queckett, Esq., F.L.S. Both authors agree in thinking that the ergot is a minute filamentous fungus; and the following conclusion of Mr. Queckett's paper may enable the gardener to form some definite ideas on the subject.

"From these observations, which have been followed up in many ergotised grasses, Mr. Queckett is inclined to believe that the ergot is a grain diseased by a particular parasitic fungus developing in or about it, whose sporidia find the young state of the grain a matrix suitable for their growth, and quickly run their race, not entirely depriving it of its vitality, but communicating to it such impressions, which pervert its regular growth, and likewise the healthy formation of its constituents, being at last composed of its diseased materials, which are mixed up with fungic matter which has developed within it.

"The fungus caused to germinate in the way described is quite invisible to the naked eye, seldom measuring beyond the one or two hundredth part of an inch; and from comparisons with British and foreign genera of Fungaceæ, it has not been found that it belongs satisfactorily to any as at present constituted; the author therefore proposes a new genus, with the title *Ergotætea*, to represent this minute fungus, which will belong to the sub-order Coniomycetes of Fries, and to its division Mucedines, very near to the genus *Sepe-donium*.

"After repeated experiments with the sporidia of the ergot of rye, of *Elymus*, and other grasses, the author has always succeeded in making them germinate, and has not discovered such differences as would lead him to consider that the parasite in each case was not the same, therefore he has applied the term *abortans*, as the specific name of *Ergotætea*, to the plant found on the ergot of rye, and believes the parasites, on the other grasses which have been examined, to be of the same species."

*Cereus tetragonus* Dec.—A paper on this plant was read by E. Rudge, Esq. F.R.S. & L.S., with whom it flowered during the three past years.

"This plant has blossomed during the three past years in Mr. Rudge's collection at Abbey Manor House, near Evesham. The flowers expand in the evening, like those of *C. grandiflorus*, which they resemble, but are not above half the size. The number of the angles of the stem is variable. The species is an old inhabitant of our stoves, but has rarely flowered."

*Irideæ of India*.—Five species from different parts of India, including Nepal and Kamaon, are described by Professor Don.

*Spongilla fluviatilis*. *The River Sponge*.—A paper by J. Hogg, Esq., M.A., F.L.S., was read.

"The author's views of the vegetable nature of the river sponge were given in a paper read before the Society on the 5th of June, 1838, a report of which was inserted in the August number of the 'Annals of Natural History.'" Here is an instance of the carelessness against which we have often had

occasion to remonstrate; viz., referring to the number of a periodical, and not to the volume and page. We suggest, in consideration of those whose time is of some value, that it should not be repeated. On turning to the paper referred to in the *Annals*, vol. i. p. 478., we find Mr. Hogg disposed to adopt the opinion of Dr. Johnston, of Berwick, in referring the sponges to the vegetable kingdom; and in the paper noticed in the Linnæan Society's *Proceedings*, p. 8., Mr. Hogg's views are supported by the fact of his having raised young sponges from the sporules, or seed-like bodies, which are found in the cells or pores of the sponge.

*Orchideæ in the Collection of Conrad Loddiges and Sons, Hackney, near London, arranged according to Dr. Lindley's Genera and Species; with their Native Countries.* 12mo, pp. 25. Lond. 1839.

In Sweet's *Hortus Suburbanus Londinensis*, published in 1818, there are not above fifty hot-house Orchideæ; but we see by this catalogue, that the number in the course of twenty years is increased to the astonishing amount of 1,024 species, and that, too, in a single collection. We are not aware that there is another instance on record of such a rapid increase in the introduction to our gardens of the species of any one single order of plants. Of the 1,024 species, of which Messrs. Loddiges possess living plants, about 700 have been named, and the greater part published; and there are upwards of 350 of which the generic name only is known, or guessed at; and which, of course, remain to have specific names applied to them when they come into flower; or, perhaps, in some cases, they may be found duplicates, or require to be constituted new genera, &c. The number of tribes contained in Messrs. Loddiges's collection is four; of the first of which, Maxalideæ, there are two sections. The number of genera is 132. This catalogue will be of great interest to the collectors of Orchideæ, though its usefulness would have been increased by an alphabetical index to the genera, and by references to figures. However, as it is, it will be hailed with satisfaction; and we only wish we could see such a catalogue of the Cactææ by the Duke of Bedford, or Mr. Harris of Kingsbury.

*Royal Asiatic Society of Great Britain and Ireland, Proceedings of the Committee of Commerce and Agriculture.* London, 1839. 8vo, pp. 82.

This Society is one of the most useful in existence; first, on account of the almost inconceivable extent of the object which it has in view, that of advancing the commerce and agriculture of both the eastern and western hemispheres; and secondly, on account of the systematic, energetic, persevering, and economical manner, in which it pursues its objects. Having stated this, it is unnecessary to add that it deserves the patronage of every man of public spirit. Happily there are among the members of this Society some men of the most liberal and extensive views; and the exertions of whom would forward the objects of any society in which they were allowed to take an active part. There are, probably, many members, who may be so designated; for the very object of the Society, that of ameliorating the condition of mankind in two hemispheres, is an idea sufficiently grand to liberalise the mind; but Sir A. Johnstone and Dr. Royle, we know, of our own knowledge, to merit this character.

Among many interesting matters in this fasciculus of the *Proceedings* are tabular views of the agricultural produce of the country around Noona, communicated by Dr. C. Lush, F.L.S., the brother of an ingenious young architect, author of several interesting papers in the *Architectural Magazine*. There is a tabular view of the garden produce of the Marathas, and one of the fruits cultivated in the gardens there. In these tables, the native, English, and scientific names of the different plants are given, together with the mode of propagation, time of sowing and reaping, uses, &c. Our limits prevent us from referring to much more, of an interesting nature, but scarcely suited to this Magazine: we cannot, however, omit the following abstract of what was stated by Dr. Royle, at a meeting of the Committee of Commerce and Agriculture,

held November 10. 1838. It will be read with benefit by every scientific gardener.

“Dr. Royle stated that, having received a letter from the secretary to the Court of Directors of the East India Company, with a sample of rice in the husk, from the Himalaya Mountains, with a view to some experiments being made on its cultivation in this country, he thought it a good occasion to make some general observations on the absolute necessity of paying attention to climate (using this word in a comprehensive sense), in our attempts at introducing into one country the culture of another, which may appear to be similar in all that is requisite for its cultivation. He observed that, though the chief object of the Committee of the Society of which he was secretary was to investigate and make known the natural products of India likely to be useful to the arts of Europe, and to introduce into that country objects of profitable culture; yet it also attended to the introduction from thence of plants likely to succeed in England. The Himalayas, for instance, produced numerous trees and shrubs suited to the climate here, many of which, indeed, had withstood the rigours even of the last very severe winter. As a kind of rice was grown on the terraces cut into the sides of the mountains on which these very trees grow in the greatest luxuriance; it has been inferred, that it would succeed in any climate where they flourished, and had therefore been repeatedly sent from Nepal to England for cultivation. The trees, being perennials, Dr. Royle observed, afforded no data respecting the cultivation of an annual, which required only a few months to bring it to perfection. To this it might be objected, that barley which grew in the same mountains had succeeded in the colder climate of Scotland; it was necessary to observe that the climate, and necessarily the culture, of the Himalayas varied much in different parts, in the same months, as well as in the same place, at different seasons of the year. Thus, in the interior of these mountains, barley was not sown until May or June, and reaped in August or September; while, on the exterior ranges, the harvest was gathering in, at the very time the seed was sowing in the interior, or at greater elevations. It is at this season that the rice is sown in places within the influence of the rainy season, which extends from about the middle of June to the end of September. In some places rice is, and in others it is not, irrigated; but rain falls very frequently, and the air is almost always in a moist state, from being charged with moisture from the heated valleys, and depositing it on the mountains, when it reaches an elevation where it becomes cooled below the point of saturation. The temperature also is so uniform, as not to vary 10° of Fahr. for three months. The climate of England, in a moist summer, is too cold, and in a fine one too dry, for an annual from such a climate; almost all the experiments made on the cultivation of this rice in England, have therefore, as might indeed have been anticipated, failed. The only exceptions have been small quantities raised in moist situations, in a warm summer; and this might no doubt, always be done with irrigation, if the warmth and regularity of the summer could be depended upon.

*The Apiarian's Guide, containing Practical Directions for the Management of Bees upon the Depriving System.* By J. H. Payne. Small 8vo, pp. 100. London, 1838.

The second edition of a work before noticed and commended, as being practical, economical, and cheap.

*The Weather Guide, or an Index to the Barometer; exhibiting the range and mean standard for every month; so as to enable persons to judge more correctly of the action of the Barometer, and to estimate more justly its important indications respecting the weather; being, in fact, as necessary a companion to the Barometer, as the equation of time is to the indication of the sun-dial at apparent noon.* The Philosophical Transactions for the last 150 years have been diligently searched, and the most eminent authorities collated. This Index cannot fail being useful to all interested in the



changes of the weather, or the fluctuations of the atmosphere. By W. H. B. Webster, Surgeon, R. N., and of the "Chanticleer." 10 in. by 13 in. London, Longman and Co. 1s. 6d.

*A Dictionary of Arts, Manufactures, and Mines: containing a clear Exposition of their Principles and Practice.* By Andrew Ure, M. D., &c. 8vo. Parts V. VI. and VII., p. 489 to p. 872.; numerous woodcuts. London, 1839.

Our last notice of this excellent work is in p. 34.; and, as it proceeds, it increases in interest. Among the articles which concern the gardener, or land-steward, in the three numbers before us, we may enumerate Flax, Flour of Wheat; Flowers, artificial; Freezing, a most interesting article; Fuel, still more so; Fumigation, Gall-nuts, Gas, Glass, Green Paints, Gum, Raisins, Gypsum, Heat-regulator, an extremely interesting article, though short; Hop, Ice-house; Incubation, artificial, in which may be seen the origin of the modern system of heating by hot water; Ink, of different colours; Iron, Iceland Moss, Kelp; Kirschwasser (a receipt for making which was given in one of our early volumes), Lead, Limestone; Ledum palustre, employed in Russia to tan the skins of goats, calves, and sheep, into a reddish leather, of an agreeable smell; and also in the preparation of the oil of birch, for making what is commonly called Russian leather; Lime-kiln, in which are given plans and sections of a perpetual kiln; Lycopodium clavatum, the seeds of which are employed on account of their great combustibility, in theatres, to imitate the sudden flash of lightning, by throwing a quantity of them from a powder puff, or bellows, across the flame of a candle; Maceration, Magnesian Limestone, Malic Acid; Malt-kiln, in which article we were surprised not to find Reid's improvements noticed (see *Cot. Arch.*, p. 595. and figs. 1148. to 1156.); Marble, Marl, Mastic, Mercury, Metals; Mines, an extremely interesting article, illustrated with a multiplicity of excellent engravings; and Muriatic Acid.

*Hints to Mechanics, on Self-Education and Mutual Instruction.* By Timothy Claxton. Small 8vo, pp. 226. London, 1839. 4s.

The first chapter of this work deserves to be read by every gardener. Its main object is to show that a young man who really wishes to advance himself in the world cannot do it better than by educating himself; and that this may be accomplished by a mechanic or labourer, even if he should work at his business from six in the morning till seven at night throughout the year. Mr. Claxton was a blacksmith, and worked during his apprenticeship in a small country village the number of hours mentioned; and yet he contrived to educate himself in various branches of knowledge, which enabled him, as soon as he had completed his apprenticeship, to get a good situation as journeyman in London, and ultimately raised him from being a working blacksmith to a directing engineer. His maxims appear to be, to *take a hint for self-improvement from every thing, and not to lose a moment of time.*

*The Year-Book of Facts in Science and Art; exhibiting the most important Discoveries and Improvements of the past Year, in Mechanics, Natural Philosophy, Electricity, Chemistry, Zoology and Botany, Geology and Mineralogy, Astronomy, Meteorology, and Geography. Illustrated with Engravings.* By the Editor of "The Arcana of Science." Small 8vo, pp. 288. London, 1839.

The *Arcana of Science*, an annual publication of the same nature as that before us, has repeatedly been noticed and highly commended in our pages. The present work appears to be a substitute for the *Arcana of Science*, and to be in every respect equally deserving of public patronage; the author thinks more so, and he is, we believe, right. But he shall speak for himself.

"The object of the present work is, to present a faithful record of such of the results of scientific enquiry, during the past twelve months, as bear upon the arts of life and society, and tend to the advancement of useful knowledge. The *Year-Book of Facts* is, therefore, the golden fruit of the great tree of

science in one year, trusting that we have been duly vigilant of its goodly growth.

"The plan of the *Year-Book* comprises the main features of our *Arcana of Science*, and something more: it will be found better adapted for general reading; its articles are more various and practical, for, by condensing and rewriting papers, omitting theoretical details and preferring results, we have registered about one thousand new facts in the several branches of useful science. We have striven to render our work popular, in the best sense of the term, by simplifying technicality and only aiming at that concentration which produces high convenience." (*Pref.*)

*The Mirror of Literature, Amusement, and Instruction: containing Original Essays; Historical Narratives; Biographical Memoirs; Manners and Customs; Topographical Descriptions; Sketches and Tales; Anecdotes; Select Extracts from new and expensive Works; Poetry, original and selected; the Spirit of the Public Journals; Discoveries in the Arts and Sciences; New Facts in Natural History, &c.* Vol. XXXII. 8vo, pp. 456, numerous engravings. London, 1838.

This singularly cheap and most entertaining and instructive work continues to appear annually, with increased attractions. The art of engraving on wood continues to improve, and the editor of the *Mirror* avails himself of this circumstance, not only to introduce pictures of a more ambitious character, but a greater number of them. Let any one compare vol. xxxii. with vol. i., or even vol. xxi. (see our Vol. IX. p. 450.). The selection of essays in vol. xxxii., for 1838, now before us, is judicious, and the engravings embrace a great many interesting public buildings connected with Railways, Cemeteries, Public Institutions, &c., and including a portrait of the Duke of Cambridge, on steel, a large folding plate of the Coronation of Queen Victoria, the State Carriage of Marshal Soult, the Masonic Offering to the Duke of Sussex, the Grand Coronation Firework Temple in Hyde Park, numerous Churches, Chapels, &c. In short, we scarcely know a better mode in which a reading gardener, who has 5s. 6d. to spare, can spend it better than in the purchase of this volume.

#### FRENCH.

*Catalogue des Arbres, Arbrisseaux, Arbustes, et Plantes, cultivés dans les Pépinières et Serres des Frères Audibert, Membres et Correspondans des Sociétés d'Horticulture de Paris, Londres, &c., à Tonelle, près Tarascon (Bouches du Rhône). Deuxième Partie. Arbres, Arbrisseaux, et Arbustes, de pleine terre.* 8vo, pp. 72. Paris et Marseilles, 1839.

This is a very interesting catalogue, from the great number of names of trees and shrubs which it contains. Some of these may, no doubt, be synonymes, but there are a number which are probably not yet introduced to England. To take the genus *Crataegus*, for example, we have *C. brizina*, *C. Watsoniana*, and *C. Zâboub*. We have seen a catalogue of the Frères Audibert in which authorities were given with the names, which we should have been happy to see in this catalogue. In a paragraph at the end, it is stated that the Council of the department of the Bouche du Rhône has voted the establishment of a model and experimental farm, to be formed at Tonelle, and placed under the direction of M. Audibert aîné. An institution of this kind in the immediate neighbourhood of so rich a nursery as that of the Frères Audibert, cannot fail, we should think, to spread a knowledge of, and taste for, trees and shrubs, independently of common agricultural knowledge.

*Catalogue des Plantes cultivées par M. Legrandais, à Avranches.* 8vo, pp. 16. Avranches, 1838.

Local nurserymen's catalogues are not bad indexes to the taste for plants in particular neighbourhoods. At Avranches, the hardy plants in most repute are the Bengal and Noisette roses, of which there are nearly 400 sorts named

in this catalogue; and there are more than that number of mixed roses. Of *Auriculas Anglais*, there are between 50 and 60 sorts. Of dahlias and chrysanthemums no lists are given, but the sorts for sale are stated generally to be very numerous. The favourite house plant seems to be the *Caméllia*, of which no fewer than 213 sorts are named. Of pelargoniums there are about 150; of *Cactus*, 89; of *Acacia*, 15; *Aloe*, about as many; *Azàlea*, 70; *Rhododéndron*, 16; *Erica*, 36; and *Magnòlia*, 24 sorts.

*Notice sur la Culture des Oseraies dans le Département de l'Aisne.* Par M. C. Millet d'Aubenton, Garde-Général des Forêts. Lue à la Société d'Agriculture, Histoire Naturelle, et Arts Utiles de Lyon, et imprimée par ses ordres. Notice on the Culture of Osier Grounds in the Department of l'Aisne, &c. Pamph. 8vo, pp. 19. Lyons, 1837.

The culture of willows, in France, differs little from the practice in England. The basket trade in the department of l'Aisne, and particularly in the arrondissement de Vervins, is carried to a great extent. The baskets, hats, hurdles (or wickerwork trays for drying fruit), open work, damask or square work, and various other kinds of manufacture, amounting to more than 200 varieties, being annually produced, to the amount of upwards of two millions of francs. These articles are not only sent to the different towns of France, and the adjoining countries, but exported to London, New York, Lisbon, and the Indies. The culture of willows for the kind of fine work chiefly manufactured at Vervins, differs from that of the willows used for making common baskets and crates, in not requiring so rich and moist a soil. Alluvial meadows, sufficiently above the level of the rivers not to be overflowed by them, are preferred to all other soils and situations. The willows grown for common coarse basket-making are planted along the margins of rivers, especially the Meuse, and they are also grown on pollards, in moist places. The species for this last purpose are, the *Salix viminalis* and *S. álba*. Those grown for fine work are, *S. purpúrea* L. (*S. monándra Hoffm.*; *Arb. Brit.*, p. 1490. and figs. 1294. and 1603., and *Hort. Lig.*, p. 96.) and *S. vitellina* L. (*Arb. Brit.*, p. 1528. fig. 20. and p. 1606., and pl. 21., and *Hort. Lig.*, p. 97.), and *S. viminalis* L. (*Arb. Brit.*, p. 1549. and fig. 1329., and *Hort. Lig.*, p. 100.). The last two species are most esteemed. Of the *S. viminalis*, which the French call osier vert, or franc, there are two varieties, noir and blanc, and both require soil rather more humid than the two other species. The osier brunette, or branch, *S. cinérea* L. (*Arb. Brit.*, p. 1558. and fig. 1332., and *Hort. Lig.*, p. 100.), springs up naturally in the osier-grounds, and is extirpated as much as possible. The purple willow, which the French call osier rouge, or osier des tonneliers, is commonly used with the bark on; but the two other kinds, after having been cut, are put into shallow muddy water; and, when they begin to grow in spring, are peeled by the same process as in England. A plantation is considered to last between 40 and 45 years, after which it is rooted up, the ground sown with oats for three or four years, and then laid down in grass, to be broken up for willow plantation at some future period. Nothing is said of the attacks of insects; but hailstones, especially when they happen in August, do great injury. Every hailstone that touches a twig produces a wound, and the twigs so wounded sell at half-price, because they can only be employed in the coarsest work. The manufacture employs from 4500 to 5000 persons, of every age, and of both sexes. Every family works separately at home, with its children and workmen, on its own account; and takes the produce weekly to the basket-merchant, who deposits them in his magazine, to be sold as wanted. Children are employed in the manufacture as soon as they are seven or eight years old.

*De l'Hybridité dans les Plantes et les Animaux.* Par N. C. Seringe. Lu à la Société Linnéenne de Lyon, le 15 Juin, 1835. Pamph. 8vo, pp. 9. Paris, 1838.

M. Seringe is of opinion that hybrids are much more rare among plants, particularly in a wild state, than is generally thought to be the case. He ad-

mits them, however, to exist to a great extent in the Cucurbitacæ, and in the genus *Pelargonium*, but not among the cereal grasses. Linnæus, he says, has given the specific name of hybrid to various plants that he suspected to be of hybrid origin, without proof of their being so. His idea was, that, since the first creation, not only a great number of species, but even genera, had been formed by hybridism. He admitted the formation of the *Veronica spuria* by the *V. maritima* and the *Verbena officinalis*; the *Saponaria hybrida*, by means of the *S. officinalis* and a gentian. He thought that the *Aquilegia canadensis* was the offspring of *A. vulgaris* and *Fumaria sempervirens*, and so on. This, however, is nothing compared with the opinion of M. Henschel, who speaks of hybrids between *Polemonium cæruleum* and a *Tropæolum*, and between the common spinach and the Weymouth pine.

*Recueil publié par la Société d'Agriculture de l'Arrondissement d'Avranches.*  
Première Année. 8vo, Nos. 1, 2, and 3. Avranches, 1838.

This is a cheap agricultural periodical, intended for circulation within the arrondissement d'Avranches. The articles are intended to be of a practical nature; and they are so plainly written, as to meet the capacity of the most humble cultivator. In No. I. is a translation of the receipt for preparing Forsyth's plaster, from the *Treatise on Fruit Trees*. No. II. contains a Report on Jauffret's manure; and No. III. contains a notice on the *Oxalis crenata*. The most useful article which we have seen in the three numbers is one pointing out the advantages of plucking the blossoms from potato plants, in order to increase the quantity and bulk of the tubers. Among the list of members we are glad to see the name of our correspondent, Bataille, Conservateur du Jardin de Botanique d'Avranches, a good botanist, and a scientific gardener. M. Bataille's predecessor edited an edition of Quintinye's *Traité des Jardins*, which was published in 3 vols. in 1789.

*Essai de Formules Botaniques, représentant les Caractères des Plantes par des Signes Analytiques, qui remplacent les Phrases descriptives; suivi d'un Vocabulaire Organographique, et d'une Synonymie des Organes.* Par N. C. Seringe et Guillard. Paris. 4to.

This is a work involving a great deal of thought and botanical knowledge; but whether, if the formulæ proposed were generally adopted, the result would contribute to the diffusion of botanical knowledge, we very much doubt. The *beau idéal* of all language, and of all formulæ, figures, and signs, is, that they should be universally understood. The memory should be burdened as little as possible with signs, in order that it may be occupied with the ideas of the things signified. What a saving it would be to the youth of the present day, if there were only one living language in Europe! and that this will be the case, in due time, we have no doubt. Nay, we go much farther. But it may be said, that, though this system of formulæ will have no tendency to the diffusion of botanical knowledge, it will promote the acquirement of it by those who devote themselves to the study of botany. This may possibly be the case: we leave that to be determined by the botanists; but, even if it should not be so, every credit is due to the authors of this work, for having made the attempt; which, as we have already said, displays much ingenuity, care, and labour.

The *Vocabulaire Organographique*, or dictionary of terms applied to the organs of plants, is copious, and contains numerous references to species, illustrative of these terms; and it is followed by a list of terms to be excluded from the language of botany, as inexact, incorrect, or superfluous. The number of these terms is no less than 1349, while that of the terms to be retained, as given in the *Vocab. Organogr.*, is 154. The reformation of botanical language is obviously a subject of very great importance; and we could wish that Professor Henslow, in his excellent Dictionary, now publishing in monthly portions in the *Botanist*, would indicate such terms as he thinks might be

dispensed with. Possibly Dr. Lindley may have done something of this kind in the forthcoming new edition of his *Introduction to Botany*.

*Plantes Phanérogames qui croissent naturellement aux Environs de Toulon*. Svo, pp. 116. Brignoles, 1838.

We are indebted to our esteemed friend M. Vilmorin for a copy of this pamphlet, which, in a botanical point of view, is extremely interesting. It contains the flora of the most southern point of France, where there is the greatest variety of soil and surface, cut into by the sea in the most irregular and boldest manner. Here the orange tree flourishes in the open air, producing abundance of fruit; and the weeds consist of many of our green-house plants. The author of this flora is M. Robert, the curator of the Botanic Garden at Toulon. He has added several plants to the French flora, and every year he, or M. Auzande of the Botanic Garden, is adding some others. The work is divided into three parts. The first contains the principal localities, arranged alphabetically, described, and a list of the more rare plants found there added. The second contains the genera and species, arranged alphabetically; and the third contains observations on some of the species.

In the preface, M. Robert informs us that the herborisations may be arranged in three classes:— I. Those which are not further than a league from Toulon, and can be accomplished in the course of half a day; II. Those which require an entire day; and, III. Those which require three days, viz. one to go there, one to examine the locality, and one to return. The most important herborisations are made in early spring, on the hilly and mountainous districts; and, later in the season, on the meadows near the sea shore. The greater part of the *Liliacæ*, the *Ericacæ*, and the *Orchidacæ*, are in flower at the end of February and the beginning of March.

In looking over the different localities, it is extremely interesting to see the names of some of the plants found there, and occasionally a notice given of the uses to which they were applied. For example, at Mourière, a place situated four leagues north of Toulon, behind a chain of mountains covered with wood, there are valleys covered with green turf, a rare sight in these countries, where the vegetation is quite different from what it is in the neighbourhood. There *Carlina acanthifolia* is found, and the inhabitants eat the receptacle of the flower as they do that of the artichoke. At Saint Mandrier the *Phormium tenax* thrives surprisingly; and at Sainte Marguerite, a league from Toulon, the *Agave americana* raises its flower-stems majestically among the rocks almost every year. Whoever wishes to renew his stock of helianthemums should go to Toulon, where he will find twelve woody species, besides an *H. guttatum* and *H. Tuberaria*, which are herbaceous.

Among the observations, we quote the following, respecting the *Agave americana*. "It is so common on several parts of the sea shore, that it seems indigenous. Some plants flower every year. It is remarked, the year before it flowers, that the centre leaves become straighter and smaller than they ordinarily are. For the first few days, the stem rises about 4 in. in 24 hours. The growth is less considerable when the ramifications which form the great panicle are developed. In the space of two months, this stem acquires the height of from 20 ft. to 22 ft.: it is then about 15 or 16 inches in circumference at its base. The whole inflorescence resembles very much several *Umbelliferæ*, such as *Férula*. I have observed that the *Agave*, according to its localities, flowers at different periods, varying from thirty to forty years: it dies after having flowered, but its leaves are not completely withered till the following year. The common people tell absurd stories about the flowering of this plant; that its stem rises 20 ft. in height in 24 hours, after an explosion like that of a cannon, and that it flowers only once in a hundred years.

*Acróstichum leptophyllum* Dec. appears to be annual, a unique circumstance in the family of Ferns. *Arundo Donax* L. always produces sterile seeds. There is a variety of *Anemone coronaria* L. in the neighbourhood of Hières

remarkable for the fine scarlet colour of its petals. Of *Alisma Plantàgo* there is a remarkable variety, with cordiform leaves, like those of *Alisma parnassiæfolia*, and which M. Robert thinks might form a distinct species. *Erica arborea L.* attains a large size; and there are many varieties, differing in the colour of the flower. *E. scopària L.* is subject to the enlargement of the young shoots from the puncture of an insect, which gives them a singular appearance. *Ficària grandiflora Robert.* differs essentially from *F. ranunculoides*, in being twice the size in all its parts, and in the stems not being stoloniferous; it grows in moist places, while the other grows by hedges, and in shady situations. *Hypéricum dentatum Lois.* appears to be an annual, or, at all events, not more than a biennial. *Quercus Flex L.* is found in many very distinct varieties, some differing in the form of the leaves, and others in that of the fruit; in some the acorns are edible, as in *Q. Ballota*.

It is impossible to glance over this pamphlet without ardently desiring to pass a month at Toulon. We spent one day there in 1819, and visited the orange orchards at Hières; but we shall live in the hope of seeing that country more at leisure.

*Le Courier Agricole, Journal d'Annonces Agricoles, Horticoles et d'E'conomie Rurale.* Paraissant chaque mois, et plus souvent, suivant l'abondance des matières. Nos. I. and II., pp. 16, for Nov. and Dec., 1838. Price 3 francs for 12 numbers.

This is an agricultural and horticultural journal, but chiefly filled with advertisements, which are inserted at the rate of 25 cents a line.

## MISCELLANEOUS INTELLIGENCE.

### ART. I. General Notices.

*KYANISING* Wood for plant labels, stakes, and various other garden purposes, has been tried during the last three years by Mr. Masters, at Canterbury. Various kinds of wood were subjected to the process, from the Lombardy poplar to the oak, and both in a green and seasoned state; and the general result was, that the process hardened and rendered more durable the exterior surface of all woods, green or seasoned; but that, at the same time, it rendered the stakes and tallies more brittle, and consequently more easily broken over by the surface of the ground. In consequence of case-hardening the outer surface, the Kyanised wood is rendered more durable, and exterior decay prevented or retarded; though, of course, decay, or dry rot, or wet rot, may go on in the heart of the wood as much as if the outer surface had never been Kyanised. In no kind of wood, green or seasoned, does the liquid penetrate farther than from an eighth to half an inch. Mr. Masters has kindly promised us the details of his experiments on this subject. In the meantime we subjoin a quotation from Barrow's *Life of Lord Anson*, in the opinion expressed in which, our readers who have tried, or think of trying, the process will feel interested. — *Cond.*

*Kyanising.* — “It is to be hoped that we shall have no more tampering with dry rot doctors and their nostrums for the preservation of Her Majesty's ships. The steeping of large logs of timber in solutions of any kind is perfectly useless: the solution penetrates only skin deep, whereas the real dry rot commences at the centre, where the fibres, being the oldest, first give way, as is the case in standing trees. The only plausible and promising preservative of timber is the gas of the kreosote procured from the distillation of coal or vegetable tar, which, when driven off in the shape of gas, will penetrate every part of the largest logs, and render the wood almost as hard as iron; so hard, indeed, as not easily to be worked. It is understood that, in Belgium, they are using it as blocks for the railroads. The worm (*Teredo navalis*), as

proved at Sheerness, will not touch it; while pieces of the same wood, steeped in corrosive sublimate, sulphureous acid, and other active solutions, were bored through and through. Let our ships be built of good sound English oak, as they formerly were, well seasoned under cover, and left on the stocks as long as they conveniently can be allowed, and we shall hear no more of dry rot, or wet either." (*Sir John Barrow's Life of Lord Anson*, as quoted in the *Mech. Mag.*, vol. xxx. p. 336.)

*Employment of Mineral Tar, or Pyroligneous Liquor, for the Protection of Walls of Masonry or of Mud.* — When the walls are thoroughly dry, towards the end of summer (having previously been either newly built or put into a state of thorough repair), they are to be coated over, once, twice, or thrice, with the tar. The last coat, immediately when put on, may be powdered with sand; and this, when solidified, may be whitewashed. In France, earthen walls, and the walls of courtyards and terraces, are treated in this manner, and so rendered of great durability. (*Annales des Ponts et Chaussées*, as quoted in the *Frank. Jour.*, vol. xxii. p. 284.)

*Preserving Specimens of Plants, or of Organic Substances generally.* — Dr. Riddell of Louisiana has found that, by wholly extracting the moisture from the specimens to be preserved, which he does by means of unslacked lime, and then enclosing them in hermetically sealed cases, they may be exposed to the light without in the slightest degree losing their colour. By carefully surrounding fresh specimens of *Rosa gállica* with fine powder of quicklime, in a close tin box, complete desiccation was accomplished in a single day; and the flowers, when taken out, were found of their natural shape and colour; but stiff and brittle from dryness. The rose or other flower or plant, insect, &c., so dried is next put into a case (like a wax flower), with a pane of glass in front, and the whole closed by means of putty so as to be perfectly air-tight. Specimens of insects, fungi, fruits, &c., are effectually embalmed in this manner; but the most practically important part of the discovery to the botanist is, that cacti, and other succulents, may be perfectly dried in a few days, and afterwards deposited in cases with glass fronts, with their form and colour perfectly preserved. The details at length are given in *Silliman's Journal*, vol. xxxv. p. 338.

— *Cond.*

*Phenomena observed in the freezing of Potatoes.* — When frozen potatoes are thawed, they frequently do not give a fourth part of the starch which they give before being frozen. The cause of this, it appears, is, that the starch, being contained in the cells, or vesicles which constitute the principal part of the parenchyma of the potato, is set free by the operation of the rasp or grater in grating them down for starch. When the potato has been frozen, however, and is afterwards thawed, the cells are no longer firmly fixed in the fibrous matter of the potato, and the grater has no longer any power to tear them to pieces. This is a most satisfactory mode of accounting for the deficiency of starch in frozen potatoes; and it also affords a proof of the great value of microscopical observation. See an important paper in *Quart. Jour. Agricult.*, vol. viii., entitled *Studies in the Science and Practice of Agriculture*, &c., from which we shall probably hereafter give an extract. In the original paper, by the discoverer of this fact, M. Payen, the different states of the cells are shown by drawings.

Every one knows that the most mealy part of a potato is immediately within the skin; and M. Payen has discovered that by far the greater number of cells of starch are in that part of the tuber, and that there are comparatively few towards its centre.

M. Payen also found that the freezing of the outer part of the potato, and the subsequent thawing, cause that bitterness which is invariably found in frosted potatoes. Before the potato is frozen, the bitter principle, being contained in the skin, is readily removed by paring or peeling; but, when the structure of the parenchyma of the potato is deranged by freezing and thawing, the bitter matter is communicated to the adjoining parts of the potato, in consequence of their comparatively fluid state.

M. Payen, quoting M. d'Orbigny, notices the simple method by means of which the inhabitants of Peru dry their frozen potatoes, and thus preserve them for food for an indefinite length of time. (*Comptes rendus hebdomadaires des Séances de l'Académie des Sciences*, No. ix., for February, 1838, p. 275.) A more full account of the above-mentioned phenomena will be found in the very excellent *Miscellany of the Botanical Register* for February last, and it is our intention to translate the original paper, and copy the engravings which illustrate it. — *Cond.*

*Ultimate Principle of Nutriment to Animals in Vegetable Food, and to Vegetables in Manure.* — According to the most recent discoveries of chemists, the nutritive matter of all vegetables is contained in globular bodies, so small as to be invisible to the naked eye. These globules afford no nourishment till they are broken, and this can only be effected by heat; either that of the stomach of animals, or that produced by boiling and cookery. The nutritive particles of manure are exactly of the same description as those of food, and they can only be burst open by the heat of fermentation, or by chemical decomposition. We learn from these facts, the importance of cookery, of fermenting liquid manures, and of mixing soils and manures of different kinds together, so as to induce chemical action. The reader will find a valuable paper on the subject in the *Quarterly Journal of Agriculture*, vol. xii. p. 445., and another in the *Journal of the Franklin Institute*, for November, 1838, p. 335. — *Cond.*

*On the Part which Soil acts in the Process of Vegetation.* — In an interesting paper, of which this is the title, read at the Academy of Sciences, by J. Pelletier, the author endeavours to show that the fertility of a soil depends on the complexity of its composition; in consequence of which an electro-chemical force is produced, which acts at once on the soil and on vegetation. According to this theory, three primitive earths are essentially necessary to the composition of a good soil. (*Journal de Pharmacie*, as quoted in *Journal Frank. Institute*, vol. xxii. p. 341.)

*To preserve Hedge-bills, Scythes, Sickles, and other Steel Instruments, from rusting,* wipe them quite dry, heat them sufficiently to melt common bees' wax, and then rub them over with it so as to cover the whole of the steel with a thin coating. The wax completely excluding the air, prevents any decomposition from taking place on the surface of the steel; and when the instrument is wanted for use, the wax is readily removed by the application of heat. (*Frank. Jour.*, vol. xxii. p. 359.)

*Grafting-Wax and Grafting-Clay.* — Grafting-wax, we observe, is at present recommended by different persons, as preferable to the grafting-clay in common use in nurseries. We admit it to be so in various cases, particularly for coating over wounds in young shoots having a large proportion of pith, such as those of the rose, the vine, the fig, the acacia, &c.; but it must be remembered, that a mass of clay surrounding a graft retains heat and moisture to a much greater degree than can ever be the case where grafting-wax is used. In all operations of the grafting or pruning kind, in the case of plants under glass, grafting-wax will probably be found a more convenient material than grafting-clay, because it requires less labour to put it on, and it has a neater appearance; while the atmosphere of the house can be kept at any degree of heat and moisture required; but for grafting fruit and ornamental trees in the open air in early spring, we think it can never be brought into competition with grafting-clay. — *Cond.*

*Absorption of Azote by Plants during Vegetation.* — It appears that during the cultivation of trefoil in soil absolutely deprived of manure, and under the influence of air and water only, this plant acquires carbon, hydrogen, oxygen, and a quantity of azote, appreciable by analysis. Wheat cultivated exactly in the same circumstances also takes from the air and water carbon, hydrogen, and oxygen; but analysis does not prove that it has either lost or gained azote. (*Annales de Chim. et de Phys.*, Jan. 1838, as quoted in the *Phil. Mag.*, March, 1839.)

*Liquid Manure.* — I am *old* enough, and yet have become a great liquid-



manure man. There is nothing like it, Sir; and I have tried it quite long enough to pronounce that our farmers are woefully blind to their own interest, not to follow the example set them by their Flemish neighbours in this particular. We are reckoned good farmers; but, so long as we continue to waste the best part of our yard muck, I cannot exactly agree that we are so good as we might be, and as, perhaps, we fancy ourselves to be. — *S. T. Stoke Ferry, Norfolk, March 4. 1839.*

*Pots for Orchidaceous Plants* are made use of, which have holes all over their sides, from the bottom to the rim, as well as the usual larger hole in the bottom. For some species, the whole of these holes, none of which are less than half an inch in diameter, are left open for the admission of air, and the emission of water and roots; for other species, some of the holes are filled up with loam. These pots were first used, I believe, by Mr. Bateman, at Knypersley, but are now in use among various growers of the Orchidæcæ. — *J. D. Dec. 1838.*

*Torrèya taxifòlia.* — In the fifth part of Dr. Hooker's *Icones Plantarum* [see Vol. XIII. p. 507.] are two figures, representing the male and female varieties of a fine taxoid tree, of medium size, named *Torrèya taxifòlia*, by Dr. Arnott, in compliment to a distinguished naturalist, Dr. Torrey, one of the authors of the *Flora of North America*. [See p. 39.] This is a native of Middle Florida, and is the *Táxus montàna* of Nuttall, in *Journ. Ac. Sc. Phil.*, vol. vii., but not the *Táxus montàna* of Willdenow, which you give as a synonyme to *Podocárpus taxifòlius Kunth*, in the *Arb. Brit.*, p. 2100. There is an interesting paper on this tree, by Dr. Arnott, in the first volume of Taylor's *Annals of Natural History*, p. 130.

*Prepùsa connàta Hook.* — This most interesting plant, in a gardening point of view, is a gentianeous herbaceous plant, from 1 ft. to 18 in. high, with beautiful large yellowish flowers. It was found by Mr. Gardener "growing gregariously on the nearly bare face of a dry rock in the Organ Mountains, Brazil, at an elevation of 5000 ft." The name of this plant is *Prepùsa Mart. connàta Hook.* "Few plants among Mr. Gardener's Brazilian discoveries have given me (Dr. Hooker) more pleasure than this." Seeds of this interesting plant were received and sown in the Glasgow Botanic Garden, but they had not vegetated when Sir W. J. Hooker called here last February. — *D. Beaton. Kingbury Gardens, March, 1839.*

*The Cow Tree, or Palo de Vaca.* — Sir W. J. Hooker lately received two bottles of the milk, or juice, of Humboldt's cow tree, or Palo de Vaca, from his friend Sir R. P. Ker, Her Majesty's consul at Caraccas, together with specimens of the branches and leaves, without flowers. He intends to make a figure from these, which will soon be published, probably in the *Botanical Magazine*. He intends, and I think very properly, to discard Humboldt's fanciful name *Galactodéndron útilè*, and retain it in the genus *Brósimum*, till he can procure flowering specimens, from which he will determine what it is. Several plants are cultivated under the name of cow tree in this country. We possess two of those brought over, some years since, by Dr. Fanning I believe, and sold to Colville. I showed these to Dr. Hooker, and he at once pronounced them to be identical with the one of which he received the specimens as above. — *Id.*

*Píceas Pinsàpo Boissier.* — There is a passage in Mr. Lawson's paper on the *Píceas Pinsàpo* (p. 109.), by which I am reminded of a memorandum I made some years since, which bears so closely on the subject of this yet doubtful species, that I shall briefly advert to it here. The passage I allude to says that M. Boissier, "after looking in vain both on the trees and on the ground for its cones, was informed by a peasant that these only began to grow in the end of spring, and that they ripened and *fell to pieces* in the beginning of winter." From the words I have placed in italics, it appears that a simple Spanish peasant, who probably "knows neither a letter nor a figure," is aware of a circumstance connected with the *fanciful* genus *Píceas*, which has escaped the notice of all the learned authors who have treated on this highly interesting family; at least

the *Arb. Brit.* and Lambert's *Genus Pinus* are silent on the point; that the cones of some species of *Picea*, but more especially those of *Picea balsamea*, do not drop off when ripe, like those of the other species of *Abietinæ*, but fall to pieces, as the peasant observed to M. Boissier; that is, the scales drop off from the axis of the cone, leaving the axis quite naked attached to the branch. It remains thus several months after all traces of the cone disappears, and, by a common observer, might be taken for dead spray. A squirrel first drew my attention to this circumstance. Seeing him busy stripping these cones, I was surprised with what facility the little fellow detached the scales to get at the seeds. To satisfy my curiosity, I climbed the tree, and found all the cones ready to throw off their scales. — *D. Beaton. March, 1839.*

There is now, March 5., in the new plantation on the south side of Kensington Gardens, a young *Picea balsamea*, which produced cones last summer, but from which the scales have all dropped off, and left the naked axis firmly attached to the branches. This is the case, also, with the silver fir, and doubtless with all the *Picea* family. The axis of the cone of the cedar of Lebanon also remains on after the scales have dropped; but in that genus the scales do not drop for several years. In *Abies*, it is well known the seeds drop, and the scales are persistent, remaining till the cone drops off. Here, then, we have a very distinctive character between *Picea* and *Abies*; the scales in the one case being persistent, and being in the other deciduous. Professor Don, in his comparative character of *Picea* in the *Arboretum Britannicum*, p. 2105., has stated that “both carpels and bracteas separate from the axis of the strobile;” but as this should be stated in a more marked manner, and contrasted with the carpels and bracteas in *Abies* being deciduous, we are greatly obliged to Mr. Beaton for calling our attention to this subject. Gardeners like him, who are at once practical men and scientific botanists, form a most valuable check on closet or literary botanists, and, above all, on makers of species. See Mr. Beaton's valuable paper on the *Fuchsia*, Vol. XI. p. 582.; and his Review of Herbert's *Amaryllidaceæ*, Vol. XIII. p. 270. — *Cond.*

*Pæonia [officinalis] Makóya.* — This hybrid or new seedling peony was raised in the Botanic Garden at Ghent. It is figured in Marnock's *Floricultural Magazine* for March, and appears to be very double, white, with some of the petals tipped with red, and most deliciously fragrant. The stock is in the hands of M. Makoy of Liège, who asks twelve guineas a plant. It is called a hybrid; but, whether it is one of intention or of accident, or any thing more than a seedling that has accidentally sported from its parent, does not appear. At all events, it promises to be a most valuable addition to our herbaceous peonies. — *Cond.*

*Asphaltic Pavement.* — Among the improvements lately introduced here is that of the asphaltic pavement. It is used for the *trottoirs*, or foot-pavement at the side of the streets, and consists of fine gravel, cemented into a solid mass by asphaltum. It is laid down hot, hardens in a few hours, and costs about 8½ francs per square metre, or 6*d.* per square yard. On the Boulevards you see it in sheets of 12 or 15 ft. square; and these are so closely joined, that it appears like an unbroken surface, a pavement without seams. It was introduced four years ago; and, according to the information I received from an intelligent individual, it has completely succeeded for *trottoirs*. Small portions of the horse causeway have also been laid with it, within the last six months, by way of experiment, but the trial is yet too short to test its merits. This causeway consists of angular fragments of paving-stone, of any shape, and from two to six inches broad, laid in the bitumen, like bricks in mortar. The stones are not thrown in at random, but disposed so as to form a tolerably level surface, with broad lines of bitumen between them. If it succeed, it will be a most important improvement; for the horse causeway in Paris is extremely bad, consisting of blocks of hard sandstone, eight or nine inches square, polished smooth by wearing, and upon which it is marvellous that any horse can keep his feet. (*The Scotsman*, Jan. 19. 1829.)

Our readers will see from this extract, that the asphalte may be used for

garden-walks of every kind, and even for approach roads. It would be expensive at first, but would probably soon be found the cheapest of all walks and roads, from its producing no weeds, requiring no rolling and no repairs. The only doubt that we have is, as to its standing frost. We fear that the ground beneath the plate of asphalté would be frozen more or less every winter, when, of course, it would expand, and raise up the surface of asphalté, which, when a thaw took place, would, of course, fall again. Whether this raising up, and falling down, would greatly derange the asphalté, is what nothing but experience can determine. Doubtless, if the asphalté were laid on a bed of masonry, of 2 or 3 feet in thickness, it would be secure from the effects of frost; but this would greatly increase the expense. It also occurs to us, that in steep situations, where the asphalté would be chiefly valuable for shrubbery or pleasure-ground walks, it might be rather slippery during frost; but this, also, must be tested by experience. We shall examine, with care, all the walks and roads in the neighbourhood of London, where asphalté has been used, that we can hear of, and report accordingly. In the meantime, we shall be glad to hear from such of our readers as have any thing useful to say upon the subject. — *Cond.*

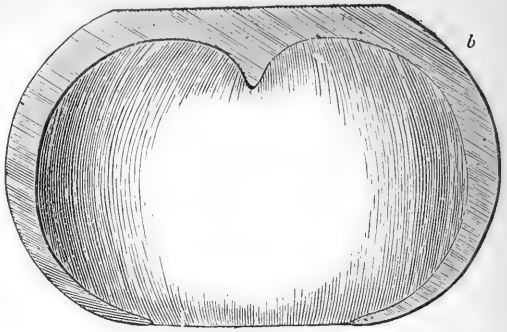
*Principle on which general Education ought to be founded.*—The common notion has been, that the mass of the people need no other culture than is necessary to fit them for their various trades; and, though this error is passing away, it is far from being exploded. But the ground of a man's culture lies in his nature, not in his calling. His powers are to be unfolded on account of their inherent dignity, not their outward direction. He is to be educated because he is a man, not because he is to make shoes, or nails, or grow cabbages. A trade is plainly not the great end of his being, for his mind cannot be shut up in it; his force of thought cannot be exhausted on it. He has faculties to which it gives no action, and deep wants it cannot answer. (*Channing on Self-culture.*)

*Music, as a Relaxation* from study, and at once a solitary as well as a social enjoyment, may be strongly recommended to young gardeners. It opens an avenue to the heart, through our physical nature; and I have often thought that it might be employed, with great advantage, to soften and refine the ruder part of our species. By giving concerts, in which music of the highest kind should be combined with the better class of our native airs, and making the admission gratuitous, or extremely cheap, I am convinced that many might be reclaimed from tavern-going and tipping; and, what is morally of great importance, the wife and children would share in the husband and father's recreation. If I were rich, I would endow a St. Cecilia's Hall, *à bas prix*, for the people. (*Scotsman*, Jan. 19. 1839.)

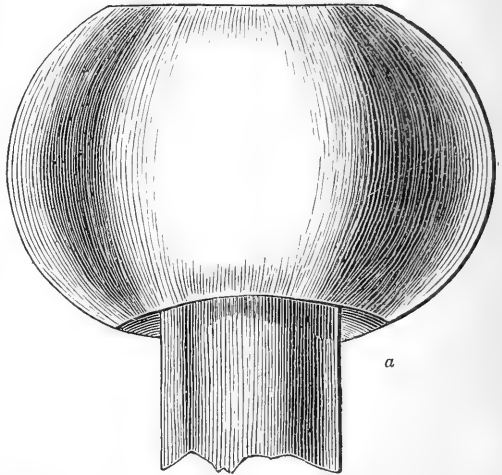
*Light.* — Sir John Herschell has lately invented an instrument for the purpose of measuring the intensity of light, and he has found that, at the Cape of Good Hope, this is twice as great as it is in this country. (*J. C. Hall*, in *Medico-Bot. Soc.*) We notice this, to impress on the young gardener's mind the great importance of light to plants; and to show him that those of the tropics do not differ more from those of the temperate zone, in requiring great heat, than in requiring intense light. The importance of light, indeed, to the perfecting of all the properties of plants, is only beginning to be understood by practical men. — *Cond.*

*An Earwig Trap for Dahlias.* (*fig. 35.* the full size: *a*, view of the trap placed on the top of a stake; and *b*, cross section of the trap. — The history of this trap has been thus given us by W. Christy, jun., Esq. — "A few years since, one of my sisters, when staying at Newcastle under Lyme, visited a pottery at St. Anthony's, near that town. The proprietor or manager of this establishment was a flower-fancier, and had made these little pots for his own use, in place of the lobsters' claws, bowls of tobacco-pipes, &c., which we so often see displayed, to the great disfigurement of gardens. Having expressed her admiration of them, he gave her half a dozen, which she brought home to me. I was much pleased with them, and fully intended sending you one, with a notice. However, they got put aside, and I forgot them for two or three

years. In the meantime one found its way into the hands of my cousin, Mr. James Christy, jun., of Broomfield, near Chelmsford, a great lover of dahlias, &c.; and he, having a pottery on his farm, made some for his own use. These were seen and approved by gardeners in the neighbourhood, who persuaded him to make some for sale. By advice of Mr. Ferguson, gardener at Hylands, he made them considerably larger than the original, which, if I remember right, was not above half the present size [that given in the figure]. Possibly, however, they were intended for other plants. I do not like the look of these large ones so well as that of the small ones; but, at all events, they form a much better termination to a dahlia-stick, than an inverted garden-pot, stuffed with hay. If painted green (which would add very little to the expense), they would be hardly distinguishable from the foliage. The price my cousin has charged for them is 3s. 6d. per cast of 60 (the same as for thumb-pots).—*W. C. Clapham Road, January 16. 1839.* [These traps, we believe, may be had of Mr. Christy's potter, Mr. Higgins, Lambeth Road.]



35



## ART. II. Foreign Notices.

### FRANCE.

*RENDERING Vegetable Substances incombustible.* — M. Letellier, of Saint-Leu-Taverny, proposes a method of rendering vegetable substances incombustible, or at least unflammable, which is particularly applicable to the timber used in building, thus preventing fires from spreading. The means consist in a concentrated solution of four parts of potash, and one part of silex (silice). Cloth, paper, wood, &c., steeped in this solution, and thoroughly dried, will not produce a flame. (*L'Écho du Monde savant.*)

*Versailles* has been put into order, embellished, and extended by the present king. It may now be considered the *National Museum of France*. Statues

are there in hundreds, and pictures in thousands. It honours, however, no art but war; and must stimulate powerfully that appetite for military glory which has been the bane of the world, and of France more than any other country. A gallery holding up war as a relic of primitive barbarism, and conquerors, who love it for its own sake, as robbers and demi-savages, would promulgate a great truth, beneficial to mankind. (*Scotsman*, Feb. 2. 1839.)

*The Government of Louis-Philippe* has done more for education than all the governments which had preceded it, from the year 1789. (*Ibid.*)

*The Spirit of moral Improvement* is daily gaining strength in Paris. Insurance against the casualties of life, savings' banks, infant schools, and other useful or philanthropic institutions, are all making progress, and some of them with great rapidity. (*Ibid.*)

*Paris has nothing to match Hyde Park and Regent's Park*; but London cannot boast of any thing like the gardens of the Tuileries and Luxembourg, the Place de la Concorde, the Boulevards, and the Palais Royal. (*Ibid.*)

*A School of Agriculture, at Rouen*, was established in December last, and three courses of lectures, public and gratuitous, are to be given by Professors Girardin, Ponchel, and Dubreuil fils. These lectures are on culture, agricultural chemistry, and agricultural zoology. (*L'E'cho*, Dec. 26. 1838.)

*A normal School of Agriculture* has recently been established at Bordeaux, by the authority of the Minister of Public Instruction. (*Ibid.*)

## ITALY.

*Monza, near Milan, February 14. 1839.* — *Garden of Desio.* The plants which Sig. John Casoretti, director of the garden of Desio, introduced last year, 1838, are as follows : —

*Ananássa* bractæata.

sativa var. Antigua royal.  
new Otaheite.  
gros clou.  
white Jamaica.  
Mehemet.

*Alstroemèria* Hoókeri.

aúrea.  
oculàta.  
pilòsa.  
acutifòlia.  
aurantiaca.  
trícòlor.  
hirtélla.

*A'rbutus* pilòsa.

*Azàlea* índica flore rubro.

índ. Smíthii speciosíssima.  
semiplèna.  
triúmphans.

*Mazéppa.*

phœnícea plèna.  
álba plèna.

fine dark purple.

speciòsa.

*Danielsiána.*

pulchérriima.

variegàta.

laterítia.

macrántha.

orange pink.

coccinea supérba.

dark crimson.

*Brugmánsia* bícolor.

*Bérberis* glumàcea.

*Caméllia* japónica fimbriàta rubra.

japónica Campbélii.

Floyü, or grand Frederick.

ochroleüca.

picturàta.

imbricàta álba.

Admiral Nelson.

Lady Grafton.

Murrayána.

Macleáni.

maculàta grandiflòra.

Collétti.

Pálmeri.

carmínea.

Elisa.

*Chorózema* ovàtum.

*Clématis* cærülea grandiflòra plèna.

bícolor plèna.

*Delphínium* phœníceum flore plèno.

*Euphòrbia* jacquiniæflòra.

*Fúchsia* fulgens.

Watson's seedling.

Yoúngü.

supérba.

*Gesnèria* Douglàsü.

*Galárdia* picta.

*Quércus* Cérris variegàta.

Nòvæ Orleanénsis.

Rhododéndron arbòreum Gaescà-	Spiræ'a lanceolàta.
num [?].	grandiflòra.
arbòreum grandíssimum.	Ròsa Báncsiæ odoratíssima.
leodiènc.	Siphocámpylos bícolor.
Smithii élegans.	<i>Lucùlia</i> gratíssima.
fromontianum.	<i>Láthyros</i> rotundifòlius.
Morcànum.	<i>Verbèna</i> incisa.
campanulàtum híbridum.	<i>Twecediàna</i> .
rosáceum.	<i>Aràlia</i> japònica.
Ketelèrii.	<i>Manétia</i> cordifòlia.
tigrinum.	

In my next letter, I will give you notices of the plants introduced into Lombardy, or rather into the Milanese, by other horticulturists.

I have not yet had time to try to make you isometrical views of the above-mentioned garden; but I shall shortly try my hand. I have been informed that a friend of mine intends engraving a bird's-eye view of this garden; and, if the speculation succeeds, he intends doing the same of all the most remarkable gardens in Italy. If this is true, I will procure a copy and send you. [We hope that some of the more wealthy of our readers will be induced to encourage such a publication, which could not fail to be a valuable contribution to the progress of landscape-gardening and garden architecture in this country. We shall be happy to receive subscribers' names, and transmit them to Sig. Manetti.]

In reading what you have said of the *Cypress of Soma* in the *Arb. Brit.*, p. 2471., I perceive that you have been led into a historical error. You say that it was this tree that was struck by Francis I. with his sword, after the battle of Pavia, in despair. It was not this tree, nor was it a cypress, which Francis I. struck with his sword, but a cypress poplar (*Pópulus fastigiàta*), which has only been cut down within these last four or five years, as I wrote in a former letter. Soma is more than 36 miles distant from Rocca Mirabello, the place where the act was committed. [We detected this error ourselves, and corrected it in the *Supp. to the Arb. Brit.*, p. 2605. and also p. 2589. of the same *Supp.*, in which we have stated the anecdote to apply to the Lombardy poplar.]

Enclosed, I send you the drawing of the *Laurel* (*Laúrus nóbilis*) of *Isola Bella*, one of the Borromean Islands, on the Verbano (Lago Maggiore). The tree is divided into two trunks, as may be seen by the drawing [which we shall hereafter engrave]; the union is at the knob (colletto) or vital knot (*nodo vitale*); its height is 19·20 mètres [62 ft. 10. in., a mètrè being 39·3 in.]; and the principal trunk, from the ground to the first branches, is 3·60 mètres high, and 2·70 mètres in circumference. No one has been able to inform me of the age of this tree; it must, however, be nearly three centuries old, if not more, and consequently anterior to the formation of the garden. It is now in decay, and, as you may see by the drawing, it has been headed down, to try to invigorate it. Napoleon cut an N in it with a penknife.

I will send you, in another letter, a list of plants which live and thrive in the open air in this mild climate, rendered temperate not by its geographical position, but by the lake. To give you an idea of this, it is sufficient to mention that *Epiphýllum speciosíssimum*, *Zàmia integrifòlia*, *Z. hórrida*, *Cýcas revolùta*, and *Acàcia latifòlia*, thrive without shelter. But, with respect to the laurels (*Laúrus nóbilis*) on the shores of our lakes, it is not a rare thing to find very fine ones: for example, in the garden of Mr. Compton, your countryman, whose villa is about five miles distant from Como, there are some astonishingly beautiful trees, amongst which there is one 16·72 mètres [54 ft. 10 in.] high, and 0·30 mètres in diameter; another 15·80 mètres high, and 0·28 mètres in diameter; and various others 15·20 mètres high, and 0·20 mètres in diameter.

*The Truffle.* Many have been the attempts to cultivate the truffle (*Tùber cibàrium Sibth.*), both before and after the publication of the method of cultivation by M. Von Bernholz, but they have all failed. It is from Piedmont

that we have our white truffles (*Tuber griseum Pers.*), which are more fragrant, have more flavour, and are therefore more in request at the tables of our gastronomes, than the common truffles; yet there were several gentlemen here who expended considerable sums in procuring the soil from those places, where they are gathered in abundance every year; but this also failed.

*Wistaria sinensis.* Here, in Monza, in the garden of my friend Sig. Gaspar Porta, a scientific amateur of botany, I saw last year, for the first time, pods (baccelli) of the *Wistaria chinensis*. They ripened perfectly towards the middle of last November. I am told that at Milan also, in the garden of Count Lorenzo Taverna, and in the garden at Desio, in 1837, they bore pods; but the seeds had not been fecundated. I have reason to believe, therefore, that this plant at Monza is the first that has produced perfect seed in Italy; as I have been informed that at Florence they have hitherto only produced flowers. The plant which produced them here grows in an isolated situation, but sheltered from the north winds, in a loam; and was planted in spring, 1831, when it was not more than 0·30 mètres high. Every year it makes shoots (cacciate) of 4·25 mètres; its trunk is 0·30 mètres in circumference. In this garden, in a flourishing state of health, there are, besides a *Magnolia glauca*, 3·60 mètres high, a *Magnolia conspicua* of the same height, several *Magnolia grandiflora*, *Quercus aquatica*, *Photinia serrulata*, *Lagerstrœmia indica*, *Cedrus Libani*, *Cunninghãmia lanceolata*, &c.

My brother, agent for the estates of His Royal and Imperial Highness our Viceroy at Pojana, in the Venetian provinces, writes to me that last year he cultivated, during summer, the batata (*Ipomœa Batatas*) in the open air, and that the plants produced tubers as large as the head of a child two months old; that they flowered abundantly, and that he hopes next year that they will produce, and even ripen, seed. The yam (*Dioscœrea sativa*) had also flower-buds, which were just going to open, when the hoar frosts set in, which were earlier than usual that year, the plants were therefore prevented flowering. This is certainly the first time that the batata, grown in the open air, has produced flowers in the Lombardo-Venetian territories. The great difficulty in cultivating this bindweed (*vilucchio*) is the preservation of the tubers in winter. But my brother informs me that he preserves them extremely well, by laying them in strata in a box or basket, among husks of corn well dried, and the basket or box hung to the ceiling (*soffitto*) of the kitchen, not on the top of the stove (*cappa del cammino*).

I see, by the *Gardener's Magazine*, that you frequently receive seeds of *Nelumbium* from India, from the celebrated Dr. Wallich. You would greatly oblige me, if you get any more, if you would have the goodness to send me some. I have a great love for those sorts of plants. I have only *Nelumbium luteum*.

My august master, the viceroy, to whom I showed the figures in your *Arboretum et Fruticetum* of the cones of the *Picea nobilis* and *P. bracteata*, was delighted with them, and desired me to beg of you to tell me where in England they are to be had. Do me the favour to let me know what they cost also. [Any nurseryman who may have plants or seeds of these species will oblige us by writing direct to Signor Manetti, at Monza, near Milan.]

The winter this year has been tolerably mild; from the middle of December to the end of January, we have had fair weather. The sun shone brightly, a rare thing in the Milanese, in which fogs are prevalent; and the temperature never fell lower than 5° under zero of Réaumur, and that only one or two nights. But at the end of January, after a slight snow, which was not thicker on the ground than a decimètre [3·93 in.], the air became so cold that the temperature on the night of the 2d and 3d of February fell to 10½° below zero; and at 2 o'clock in the afternoon of the 3d to 5° below zero. After that day, however, the air became warmer, so that in the night of the 6th current the thermometer marked its lowest depression ½° above zero; and on the 7th 5° above zero. We have now in flower *Veronica agræstis*, *Lamium purpureum*, *Alsine media*, *Capsella bursa pastoris* [*Thlaspi b. p. L.*] *Viola odorata*, &c. *Erophila vulgaris* [*Draba véna L.*] was in full flower at Natale.—G. Manetti.

## FINLAND.

*The Boundaries of Bread Corn in Finland.*—Corn is grown in the neighbourhood of Uleaborg and Torneo, but chiefly barley; farther south, rye is also grown, and wheat is only grown in the south, and that but very rarely. In these regions, on an average, the produce of the seed sown is, for barley, five-fold; for rye, eight-fold; but failures in harvests are not uncommon. The seed is sown in the course of May (new style), as soon as the grain is dry. The harvest takes place at the end of July or beginning of August. The sun, during the summer, disappears under the horizon for a short time only; and, there being little difference of temperature between day and night, vegetation advances very rapidly. There are instances, at Torneo, of reaping following the sowing within seven weeks. Oats are never seen in Uleaborgs-Län. In Wasa-Län they are rather common. Herr Besser, in travelling from north to south, first found this grain, about four Swedish miles from Camba-Carlby, half way between the towns of Uleaborg and Wasa. However, barley is the common grain there, though towards Wasa rye is more frequent. In the south the Kumo forms a distinct boundary. The soil along the left bank of this river is well cultivated. The common grain is rye. Here there are also oats and flax in abundance, particularly at Lautakyla, where the Kumo makes an elbow: as a set-off to this, barley diminishes remarkably. Under these circumstances, the idea was natural that the wheat boundary could not be far off; and, in fact, Herr Besser met with some fields of wheat behind Lautakyla, on the road to Tammersfors; but these were all. At a subsequent period, however, Herr Besser saw a small field of wheat between Tammersfors and Tawastehus. At Kymmene, under the same latitude, wheat is also to be met with. But these are solitary instances, which only show that wheat does actually live in these parts of Finland.

It thus appears that wheat thrives even in Finland, under the 61st degree of latitude; that oats grow on the coast as far as the 64th degree; and rye almost to the 66th; and that barley is found growing one degree beyond the polar circle. (*From the German, by G. R.*)

## INDIA.

*Culture of the Tea in India.*—In the *Times* of January 10. 1839, is an article entitled “The genuine Tea Plant in Upper Assam.” It is stated to be compiled from two important pamphlets on the subject, and principally from one by Mr. Bruce. The article is of considerable length, and we shall only extract from it what is interesting in a gardening point of view.

“Does the China tea plant grow mostly on the mountains of China, or in the valleys? About seven parts grow on the mountains, and three in the valleys. — Does the tea plant grow amongst the snow? Yes. — Does not the snow kill or hurt the plants? It hurts them very little: it may kill some of the old trees, but often new shoots come up from the old plants. — Do you ever sow or plant in the shade, or have you any trees to shade the plants? No; there are a few large trees, here and there, but not for shade. — If your plantations are on the side of mountains, they cannot have the sun all day? True; in some plantations the plants are in the shade for half the day: some China merchants, that come to purchase tea, pretend to know which is shady, and which is sunny, by the smell, the sunny being preferred.

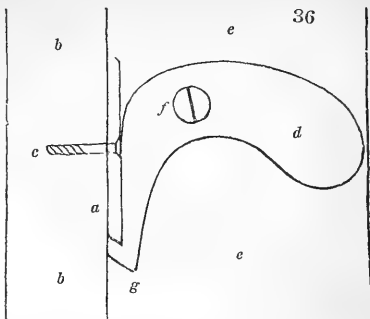
“The tea plants in Assam have, in general, been found to grow and to thrive best near small rivers and pools of water; and in those places where, after heavy falls of rain, large quantities of water have accumulated, and, in their struggle to get free, have cut out for themselves numerous small channels. (*Times*, Jan. 10. 1809.)

## NORTH AMERICA.

*An American Sash-fastener.*—In *fig. 36. a* represents a plate of brass or other metal, fastened to the sash-head (*b b*) by the screw-nail *c*; *d* is a piece of



the same kind of metal, fastened to the sash-style (*ee*) by the screw-nail *f*. When the sash is to be pushed up, the piece of metal *d* is moved upwards by the finger, and this piece, working on the screw *f*, loosens the lock or catch at *g*, from the other metal plate *a*. In drawing down the sash, the piece of metal *d* naturally falls into its place again, and fastens the sash to the sash-head, as before. I have seen this sash-fastener in use in various parts of the United States; but whether it is of transatlantic or European origin, is more than I



can tell. In old-fashioned green-houses, with the front glass in two sashes, as in common windows, this sash-fastener may be useful, being very easily made, and consequently not dear. — *James Frewin, Builder. Kingsland, Nov. 1838.*

*Spencer Wood, near Quebec, Oct. 10. 1838.* — My summer has been so devoted to gardening pursuits, to putting up grape-houses, laying out parterres, and to matters thereunto belonging, that I have literally forgotten the world, and even myself. This, I trust, will be my excuse for not having sooner written to you. I had intended to make a large collection of indigenous plants, and to attach a Canadian flora to my English flower-garden, and send you a list of the contents of both gardens, that you might know what will stand the open air in this country; but you must wait another year. My park is finely wooded with the most beautiful oak trees in this part of Canada, and of these I send you a few leaves and acorns. [The acorns were without their caps, and therefore we cannot with certainty determine whether the species is *Q. rubra* or *Q. coccinea*, but we think it is the former.] With these I send you two plants of *Sarracenia purpurea*, two cypridium, three hepatics, one plant of what the Canadians call ginger root, producing a flower very early, as white as the snowdrop, and by some called the Canadian snowdrop; and also some Canadian lily seed [*Lilium canadense*]. This Canadian lily I transferred to my garden some years ago, and it has since been universally admired, both by natives and strangers. The plant, though found in abundance in some spots, had not attracted notice here till lately, though we have an innumerable number of collectors of flowers. None of these flowers, however, can rival the Canadian lily, for elegance of form, both of the flower and stem. We have had a most lovely season, the finest I recollect to have occurred during my residence of nearly thirty years in Canada. — *Henry Atkinson.*

Our readers will find an account of this gentleman's residence in Vol. XII., p. 467. By some mistake, which we are now unable to account for, the name of the proprietor is stated there to be William Atkinson. — *Cond.*

### ART. III. Domestic Notices.

#### ENGLAND.

*EFFECTS of the Hurricane of January 7.* — In our last (p. 91.), we stated the number of trees destroyed in Knowsley Park at 3283, it should have been, as the Earl of Derby informs us, 3287. — *Cond.*

In the park at Lowther Castle, the number of trees blown down or mutilated amounted to 9767. Among these were, a larch 110 ft. high, with a clear stem of 50 ft., containing 78 ft. of timber; a Scotch pine 103 ft. high, containing 347 ft. of timber; one 100 ft. high, containing 263 ft. of timber; and one 72 ft. high, containing 187 cubic feet. A Spanish chestnut, 104 ft. high, contained 278 cubic feet; and oaks were blown down containing from 300 to

400 cubic feet of timber each. In these calculations, the number of solid feet in the trunk, or bole, only, is given; some of the trees containing at least 100 cubic feet more in their tops. (*Joseph Benn*, in the *Carlisle Patriot*, as quoted in the *Gardener's Gazette*, Feb. 9., p. 90.)

*Musa Cavendishii*. — A plant of this species is now beautifully in fruit in Mr. Harris's stove at Kingsbury, and another equally so in Mr. Harrison's stove at Cheshunt: from the former, we received two fruits on Jan. 11., which we kept till Jan. 14., and then tasted, and found them rich and well-flavoured, notwithstanding the want of sun at this season. — *Cond.*

*Gigantic Cactus*. — Among a recent importation of *Cacti*, by Thos. Harris, Esq., of Kingsbury, is a plant belonging to the *Melocacti* division, which measures 4 ft. 10 in. in circumference; and which is undoubtedly the largest specimen of *Melocactus* in Britain. Mr. Beaton, Mr. Harris's gardener, observes that, if this specimen were divested of its spines and ribs, it might be taken for an old-fashioned Scotch haggis. — *Cond.*

*Progress of Education*. — The Central Society of Education held a meeting on February 23. principally for the purpose of presenting the prize of 100 guineas, awarded by the Society to Mr. Lalor, for the best essay on the "Means of elevating the Condition of Instructors." The prize was awarded by the decision of Professor Malden, of the University College, and was delivered to Mr. Lalor by Mr. Wyse, M.P., who, in so doing, descanted, in a speech of great eloquence and power, on the station at present held by that class to whom the world is so much indebted, and so little thankful. "The vocation of a schoolmaster," justly observed Mr. Wyse, "is a high and holy one, of deep importance to the state; for the school makes the nation, and the teacher makes the school. Abroad, this great truth is beginning to be felt; and we, perhaps, of the nations of Europe, are the only people to whom at present it seems yet completely to be learnt." But, by the systematic exertions of the Society, and especially by the admirable essays about to be published by them, he added that he confidently hoped the public mind would be roused to a consideration of this vital subject. (*Morn. Chron.*, Feb. 25. and 26., 1839.)

*Gardeners' Benevolent Association*. We observe, in the *Gardener's Gazette* of March 9., that this Society, which has been under discussion in that journal for some weeks, is finally established, the Duke of Cambridge having accepted the office of President. It is but justice to Mr. Glenny, to state that this result is entirely owing to the energetic manner with which he follows up whatever he takes in hand. When the rules and regulations of the Society are finally adjusted, we shall be happy to give them publicity, gratis, in our advertising sheet. — *Cond.*

## SCOTLAND.

*Effects of the Hurricane of January 7.* — In Dumfriesshire more damage appears to have been done than in any other county of Scotland. At Arbigland, the seat of a family celebrated in the agricultural history of Scotland, upwards of 100 old trees were blown down. On the Earl of Mansfield's estate, between Dumfries and Annan, above 1000 trees were destroyed; and a number of other places are mentioned in the *Dumfries Courier* of Jan. 9., as having lost from half a dozen to 200 trees and upwards. "At Dalscone, still greater damage was done in the same way; and at Gill, on the road to Craigs, a tree supposed to be 200 years old was not only uprooted, but lifted into the air, notwithstanding its great bulk. In its descent, it lighted on another goodly tree, where it still dangles, with its roots uppermost and top downwards." (*Dumfries Courier*, Jan. 9.) In the same journal, for January 23., a number of other instances are given, and among these one where 10,000 trees were blown down or broken over. The pine and fir are said to have suffered in the proportion of 30 to 1. Those having roots like the oaks suffered least; and it is very properly suggested, that, "where any of the roots of oak remain in contact with the soil, it will be wise to let them alone till the spring; the sap will then move to some extent, and the bark will be rendered available,

which, at present, is entirely useless for tanning purposes, from induration and the impossibility of separating it from the trees." In the same paper, for February 5., the old giant ash tree of Dalswinton is said to have been blown down; and the three brethren of Closeburn, an oak with three equidistant trunks, very much alike in appearance, and precisely similar in girth, also gave way. The timber of this tree measured 561 cubic feet; it is estimated to have been upwards of 500 years old. After this tree was blown down, a mountain ash was observed growing out of it, a proof that its trunk must have been in a state of decay. The injury done to the woods of Dumfriesshire, taking them as a whole, is estimated, by the editor of the newspaper quoted from, at 10 per cent. Sir W. Jardine informs us that at least 40 acres of woods at Rae Hills, have been blown down, and that thousands and thousands of trees lie prostrate around Jardine Hall, to the distance of from 10 to 15 miles in every direction.—*Contd.*

*The Highland Society of Scotland*, at their Glasgow show, gave away prizes for papers on the following subjects, more or less connected with gardening, and which we hope to see published in their *Transactions*. To H. R. Madden, Esq., Warriston Crescent, Edinburgh, for an Essay on the Mode in which Soil operates in promoting or facilitating the Germination and Growth of Vegetables, the Honorary Silver Medal. To Mr. James Jackson, Plaintree-shade, near Pennicuick, for an Essay on the Effect of Woods on Climate, Five Sovereigns. To Colonel Miller, Urquhart, Fifeshire, for an Essay on the Disease which has lately attacked the Silver Fir, the Honorary Silver Medal. To Mr. James Balden, forester to Lord Blantyre, Lennoxglove, by Haddington, for an Essay on the same subject, the Honorary Silver Medal. For an Essay on the Improvement of Waste Land by Planting, signed "Robur," Silver Medal. To J. S. Hepburn, Esq., of Colquhalzie, for a Paper on the Construction of Stables and Farm-houses, the Honorary Silver Medal. For a Communication on an improved Method of burning Tiles, by Mr. James Taylor, Meorded Tile-works, Ayrshire; and to Mr. Robert Laing, jun., Campend, near Dalkeith, for an Essay on Subsoil and Trench-ploughing, Five Sovereigns. Besides these the Silver Medal was voted to five Essays on preserving Potatoes, and "thanks" for six Essays more on the same subject. Thanks were also voted for an Essay on Ventilators for Grain and Stacks; for an Iron Scarifier for Grass Lands; for an Essay on Tanks; for one on Shelter as a means of Improvement; and for one on the Chemical Properties of the Juice of Potatoes. The Silver Medal was voted for each of two Machines for sowing Grass Lands; for a Machine for spreading Soot on Land as Manure; and one for the Model of a Bee-house. To Mr. Thos. Bishop, land steward, Methven Castle, Perthshire, for a Report on a Species of Grass, new in the cultivation of the country, thanks and a Silver Medal were voted. (*Scotsman*, Jan. 30. 1839.)

*Progress of Cottage-Gardening in Fifeshire.*—We are always delighted to witness a taste for the cultivation of trees, shrubs, and flowers; and, when this is confined not entirely to the garden, which, in Scotland, is generally behind the house, but extends to any spare plot in front, we do not know anything more refreshing to the eye of the traveller, or, perhaps, better fitted to impress his mind with a favourable idea of the inhabitants. Of late years the north of Britain has shown a wonderful improvement in this respect; so that now it is no uncommon thing to see detached cottages, and cottage-rows, embellished with flowering shrubs and odoriferous creeping and clinging plants; while, in many of the towns and villages, spaces of ground, formerly unoccupied, and really a nuisance, are now set apart for the growth of shrubs, and ornamental and forest trees. In not a few of the newly sprung up villages of Fife and elsewhere, a space is lined off, in front of the houses, for the reception of such plants as the occupiers may be pleased to treat the public to; and sorry are we, when we find any of these desecrated to culinary purposes. In passing through a manufacturing town lately, we were gratified to observe a beautiful plant, the *Arbutus Andrachne*, surrounded by

a number of rare and half-hardy shrubs, all in a thriving condition, and growing within a few feet of the turnpike road. (*Fife Herald*, Feb. 21. 1839.)

An *Ornamental Cemetery* has been proposed for the city of Edinburgh, by Mr. Geo. Smith, Architect. "Enclosed tombs or vaults are placed round the boundary walls, while the centre portions are set apart for the monuments and cenotaphs of those who merit a public testimonial from their grateful countrymen, or private ornamental monuments; the whole to be interspersed with shrubs, and laid out with much attention to landscape-gardening." (*Scotsman*, Jan. 30. 1839.)

*Rhododéndron arbóreum* has flowered in the gardens at Cally, in Kirkcudbrightshire, where, being a rarity, it has been greatly admired by the neighbourhood; who, at the same time, had the opportunity of witnessing the high order in which every part of the garden scenery at Cally is kept by the gardener, Mr. Pearson. The *Rhododéndron*, though not more than five feet high, had twenty-two heads of blossom, all more or less expanded at the same time. (*Dumfries Courier*, Feb. 27. 1839.)

#### IRELAND.

*Effects of the Hurricane of January 7.* — We are informed by Mr. Mackie, of the Trinity College Botanic Garden, Dublin, that the hurricane in Ireland has been as fatal to the woods and plantations as in Scotland. The plantations, he says, at Collon, the demesne of Lord Ferrard, so often referred to in our *Arboretum Britannicum*, have been dreadfully injured, "as well as those of all the principal demesnes in Ireland." — *J. T. M.* Jan. 20.

The *Kilkenny Moderator*, speaking of Collon, says, the magnificent wood of silver fir, which formed the western barrier, and gave such retirement to the temple and grounds, has been entirely swept away; nothing remains of it but a few broken stems here and there, pointing out what once had been the pride of the late Lord Oriel. The American grounds, which have been so improved by his son, Lord Ferrard, are a scene of desolation; the towering pines, the numerous species of ilex, the rare black larch, the fine magnolias, the cedar and Goa cedars, and other specimens of the rarest trees, which have been collected from all quarters of the globe, now lie prostrate. Nothing can equal the desolation of the scene, and the more distant parts of the grounds are even wrecked in the same manner. We hear the neighbouring seats have likewise severely suffered; but the proprietors appear to forget their own loss in that beautiful and perfect place, which all travellers and botanists have so justly admired. (*Kilkenny Moderator*, as quoted in the *Morning Herald* of Jan. 22. 1839.) In the park of Lord Charleville immense damage has been done; and, in the county of Limerick, three acres of bog were moved to a distance of three miles, crossing in their journey a rapid river, and leaving on the spot where they stood a surface of pure yellow mould. (*Limerick Chron.*, as quoted in the *Dumfries Cour.*, Jan. 30.)

#### ART. IV. *Royal Caledonian Horticultural Society.*

THE spring meeting of this Society was held in the Council Room, at the Experimental Garden, Inverleith, March 7. Notwithstanding the great inclemency of the weather, the display of fine flowers was very considerable, and the attendance of professional and amateur cultivators was numerous.

For the prize offered for the six finest and newest varieties of camellias, four collections had been sent in in competition. The silver medal was awarded, as first prize, to Mr. James Kelly, foreman to Messrs. Dickson and Sons, Inverleith Nurseries, the kinds being *Juliana*, Gray's invincible, *Chandlerii*, *hórrida*, *reticulàta*, and *Fairlei*. A second prize was voted to Mr. Robert Watson, gardener to David Anderson, Esq., of Moredun, whose kinds were Gray's invincible, *reticulàta*, *Juliàna*, *imbricatà*, *Colvillii*, and *Lady Eleanor Campbell*. The committee observing in a third parcel a new variety, marked

as imported from China by Mr. James Nairne, of Claremont, voted an honorary premium to Mr. Brewster, at Balcarres, who had sent the flowers, and they named the variety *Caméllia Nairniana*.

For the prize offered for the four finest species of *E'pacris* in flower, three competitors appeared, and all the collections were considered meritorious. The first premium was found due to Mr. Kelly, Inverleith Nurseries, whose species were *E. impréssa*, *ceriflôra*, *pulchélla*, and *variabilis*; the next to Mr. Watson, Moredun, who produced *E. impréssa*, *rôsea*, *púngens*, and *nivàlis*; the third to Mr. John Addison, gardener to the Earl of Wemyss, at Gosford, whose collection included a remarkably fine variety of *E. variabilis*.

For the prize offered for the finest plant in flower, exclusive of the preceding genera, and of recent introduction, five competitors came forward. The silver medal was awarded to Mr. David Brewster, gardener to Colonel Lindsay of Balcarres, for *Cinerària formôsa*, having blossoms of an intensely brilliant purple, and possessing the character of novelty. For a well-grown specimen of *Euphórbia jacquiniæflôra*, beautifully trained around a light oval trellis, a premium was voted to Mr. Kelly, Inverleith Nurseries.

For the prize offered for the best six named Hyacinths, there were no fewer than six competitors. The silver medal was voted to Dr. Adolphus Ross, whose kinds were, *Voltaire*, *Vulcan*, *Rouge éclatante*, *La grande Vidette*, *Anna Maria*, and *Porcelaine sceptre*. For another fine collection, consisting of *Emilius*, *Lord Wellington*, *Bouquet tendre*, *La grande Vidette*, *Voltaire*, and *Amicus*, a premium was again found due to Mr. Kelly, Inverleith Nurseries.

There was no competition in late dessert pears, last season being very unfavourable for their production. But two prizes were awarded for apples; the first to Mr. James Murray, gardener to Andrew Fletcher, Esq., of Salton, the kinds being *Ribston*, *Phillips's General Wolfe*, *Margil*, winter strawberry, scarlet golden pippin, and *Empress Josephine*; and the next to Mr. William Thom, gardener to David Anderson, Esq., of St. Germain's: kinds, *Orange Blenheim*, *Luffness matchless*, *Paradise pippin*, *Emperor Alexander*, *Ribston*, and *Fulwood*.

The only kitchen vegetables exhibited were, forced sea-kale and forced rhubarb-stalks, both of good quality. For the sea-kale a premium was awarded to Mr. James Thomson, gardener to William Keith, Esq., Corstorphine Hill; and for the rhubarb, to Mr. Robert Miller, market-gardener, Gorgie.

Two excellent bunches of white raisin grape, recently cut from the tree, the vinery having, during winter, merely had fire-heat sufficient to dry off the damp, were sent from the garden of Sir David Erskine at Cambo. This is the variety so largely imported from abroad under the name of the Portugal grape. It was mentioned that the vine had "proved a very sure bearer at Cambo, not having missed a crop for the last thirty years, and that it is well worth a place in every late vinery." The silver medal was voted to Mr. James Falconer, gardener at Cambo.

It may be added, that there were sent for exhibition a specimen of the rare *Brugmánsia lútea*, or yellow trumpet-flower, from the garden of Sir Archibald Campbell of Garscube, and some beautiful varieties of camellia from the gardens at Prestongrange and Edmondstone. — *P. N. Edinburgh, March 9. 1839.*

---

#### ART. V. *The West London Gardeners' Association for mutual Instruction.*

*HAMMERSMITH, Oct. 15. 1838.* — Mr. Russell read an essay on Moral and Intellectual Improvement. He observed that so long as man remained in a state of ignorance, nature is never contemplated with a clear conception for the purpose of promoting the true enjoyment of the human race, or with a

well-grounded confidence in the wisdom and benevolence of its Author. On the other hand, man, when he is civilised, and illuminated by knowledge, perceives the scheme of creation to be admirably adapted to support the mental faculties in habitual activity, and reward him for the proper exercise of them. That it was highly important for human beings to become acquainted with every object around them, that they might discover its capabilities of ministering to their own advantage. He recommended, in strong terms, the cultivation of the intellectual faculties; and showed that man must live in society to be either virtuous, useful, or happy; that man could not exist to virtuous ends out of society, neither could he in a right frame of mind in it, if the moral atmosphere with which he is surrounded be deeply contaminated with vice and error. But, if we cultivate the powers which God has given us, and employ them on the objects which he has placed within our reach, we not only consult our own best happiness, but we render to him the highest tribute of obedience. Mr. Russell further stated that, although the condition of our existence on earth be such as to preclude an abundant supply of the physical necessities of all who may be born, there was no such law in nature against that of our moral and intellectual wants; that the Creator never intended that man should live on bread alone, but he has other higher and nobler wants. In conclusion, he urged the necessity of the members' regular attendance during the winter season, when they had time to spare, and lamented that there was such a callous indifference among gardeners to support such a useful Society. If an individual, in the course of a consistent life, may modify the minds of many with whom he comes in contact, how much greater must not an Association like this be: it is surely an ennobling conviction, would that it were more generally held! that the most insignificant amongst us may aid in creating an influence that may ultimately tend to regenerate society.

Mr. Caie approved of the essay, with the exception of Mr. Russell's laying so much stress on the number of books now published, many of which were not on a right principle, neither calculated to enlighten the minds of men, nor promote the happiness of the human race. But, on the whole, he considered the essay a work of genius.

Mr. Gray contended that Mr. Russell had omitted the most material parts of the subject; as he expected that he would have pointed out more clearly the best way for improving the mind. He (Mr. Gray) considered that happiness depended chiefly on benevolence, and that the best moral precept "Do as we would be done by."

Mr. Keane disapproved of such subjects being discussed in a Gardeners' Society, as he thought that subjects more connected with their own profession would be better calculated to promote the interest of the Association; in as much as whatever a man's daily occupation in life is, he is always most anxious to learn something relative to it; consequently, the mind must be more susceptible of receiving instruction on such a subject, than on one with which he is unconnected.

Mr. Ronalds stated that he felt disappointed by not hearing some subject discussed in a Gardeners' Society bearing more on its profession; and observed that botany was a delightful study, and ought to be more generally cultivated among gardeners than what it is; and recommended those who wished to become acquainted with such subjects as Mr. Russell had brought forward, to read the works of the Greek and Roman philosophers.

Mr. Caie briefly explained the object of the Gardeners' Association (with which Mr. Ronalds was unacquainted); being to afford those means of instruction to the young gardener whose limited circumstances deprived him of the means of obtaining the works either of ancient or modern philosophers.

Mr. Russell, in support of his essay, considered that Messrs. Keane and Ronalds had taken a wrong view of the subject, as being unconnected with a gardener's profession; and showed that nothing was more wanted, or better calculated, for the occasion, than moral and intellectual improvement. No

matter whatever a man's occupation in life be, let him cultivate his intellectual faculties; and he will find that, in proportion to their cultivation, will his way be extended. If he had referred to past ages, and the slow progress society had made, to learn the probable result of knowledge, we must first ascertain the actual result of ignorance; prove the danger of the one, and we will establish the utility of the other. He did not mean to establish the fact, that all the books which were daily issued from the press had a tendency to lessen the misery, or promote the happiness, of the human race; on the contrary, many of them were more calculated to deprave the mind, and thereby increase misery. But it is an indisputable fact, that there is a general demand for intellectual food, and that a wholesome supply has proportionally increased.

#### ART. VI. *Retrospective Criticism.*

*Pinus Pinsapo Bois.* — I have read with very great interest the communications of Mr. Lawson and M. Vilmorin (p. 109. and 111.), respecting the new pine observed in the neighbourhood of Ronda, which, it appears, is something of *Abies pectinata*. I felt the more interested in it, because I was aware, before I left Spain, that there was a pine, differing from the others, in the neighbourhood; and it is announced in my work, vol. ii. p. 239. I was indebted for my information to an Andalusian lady, whose family had property near the locality where it was pointed out, and she promised to procure me cones, &c.; but the unfortunate circumstances of the country since that period have prevented it, and, as usual, we are indebted to foreigners for the information which a day's delightful excursion from Gibraltar would have enabled any one to obtain. The name of "Pinsapo," I think, is provincial, and not Castilian, or regular Spanish, but it is excellent in itself. Before we add another species to our long catalogue, let us examine carefully, whether it be not, as I have little doubt it is, identical with the *A. cephalónica*, with which it perfectly agrees in latitude and elevation of site. My reason for supposing it to be a *Pinus* was, that the site in some degree corresponded with that of the Sierra de Cuença, the upper zone of which is composed of *P. sylvéstris*. The information respecting this interesting species was obtained just as I was leaving Spain, and had no opportunity of ascertaining its exactness. Not long before this I set out on a route from Malaga to Gibraltar, by the mountains, which would have carried me through the locality; unfortunately one of my horses died at Antequera, and I was obliged to return to Malaga, when the lateness of the season prevented me again undertaking it.—*S. E. Cook. Carlton, March 10. 1839.*

The passage to which Captain Cook refers, we conclude to be the latter part of the following paragraph:—

"The Serrania de Ronda terminates the southern section of the forests. In the barrancos and river courses is *P. Pináster*, which is used at Marbella for smelting the iron ore. Mixed with it, but lower down, is *P. halepénsis*; and to the western side, I believe, *P. Pínea*. High up, on the most elevated ridges of the Serrania, is a species I have not been able to classify, and know only by the vague descriptions of the natives, obtained too late to enable me to visit the places. It grows on St. Cristobal, and the Sierra de la Nieve; and is not improbably, from the description, *P. sylvéstris*." (*Sketches in Spain*, vol. ii. p. 239.)

*Picea Pinsapo* seems nearly allied to the silver fir, though the seedlings are, perhaps, rather longer in the leaves. If decidedly distinct, it will be an interesting addition to the arboricultural treasures of Spain, as well as a proof of the negligence manifested by botanists, in overlooking, or rather underlooking, the most noble and useful portion of the vegetable creation; while they hesitate not to devote the most scrupulous attention, in endeavouring to multiply species of the humble genera which compose the turf under their feet.—*W. G. Edinburgh, Jan. 19. 1839.*

ART. VII. *Queries and Answers.*

*CUT Flowers sent from Paris to London.* — This is said to be the case, in the *Annales d'Agriculture de Lyon*, vol. i. p. 259. These flowers are sent from Paris in boxes hermetically sealed, and arrive at London, Vienna, Berlin, and even St. Petersburg, as fresh as the moment when they were gathered. We were not aware of this, and should be glad to know, from our correspondents on the Continent, and our readers in London, to what extent it is true. We know that, during the winter season, flowers are sent from Genoa to Milan in this manner. — *Cond.*

ART. VIII. *The London Horticultural Society and Garden.*

*JULY 11. 1838.* — *Exhibition at the Garden.* This exhibition, the last for the season, was attended by 6546 visitors, and was not less remarkable than either of the preceding, for the number and beauty of the objects placed upon the table. [The list of the awards will be found in our preceding volume, p. 396.]

*JULY 17. 1838.* — *Ordinary Meeting.* The following objects were exhibited: from Mr. William Cock, jun., of Chiswick, a collection of 12 very fine Pelargoniums, of most unusual size and beauty. From A. B. Lambert, Esq., F.H.S., a specimen of *Pourrètia rubicaulis*, a large bromeliaceous plant with dull purple flowers, native of Chile, now blossomed for the first time. From J. L. Elliot, Esq., F.H.S., some finely grown cucumbers. From S. Rucker, Esq., jun., F.H.S., specimens of the curious *Stanhopea insignis*, and a species of *Cirrhæa*, apparently not different from *C. tristis*. From Messrs. Chandler and Co., of Vauxhall, a specimen of *Zigadènus élégans*, a rare and curious North American herbaceous plant, with pale green and white flowers, in size and form resembling those of an *Ornithogalum arabicum*. From John Williams, Esq., C.M.H.S., of Pitmaston, near Worcester, specimens of *Dictamnus álbus*, in a monstrous condition. Mr. Williams stated, in a letter which accompanied the specimens, that the plant producing them had previously borne flowers of the ordinary kind; that in May it was freely watered with a liquid the colour of coffee, taken from a tank receiving the drainage of a stable-yard; that in the July or August following it was again watered with the same mixture, having about an ounce and a half of green vitriol (sulphate of iron) dissolved in it, Mr. Williams having in a former experiment found that this salt gave the leaves of the *Hydránga* a very dark green colour, and caused the production of some blue flowers. To this treatment of the fraxinella, however, Mr. Williams did not assign the monstrosity in question, because the two adjoining plants, which had the same treatment as to liquid manure, flowered this year in great perfection. But the leaves, this year, of the plant which produced the monstrous flower, were stated to be of a more yellow colour than those of the two adjoining plants; which was not the case the preceding year. The sulphate of iron was broke into small pieces, and the ounce and half mixed in a water-pot containing about three gallons; it appeared possible that the plant with monstrous flowers might have received the last portion, from the bottom of the water-pot, more highly charged with the solution of iron.

This proved to be an instance of one of those monstrous formations sometimes found in plants, when the parts of the flower resume more or less the state of leaves, and which thus explain the laws upon which flowers are constructed. It appears, from the observations of botanists, that a flower is a bud the scales or rudimentary leaves of which are arranged in circles within each other, and changed in form, colour, and even structure according to the offices they have to perform in their altered condition. For this reason, however different the calyx, the corolla, the stamens, or the carpels, of a flower may be



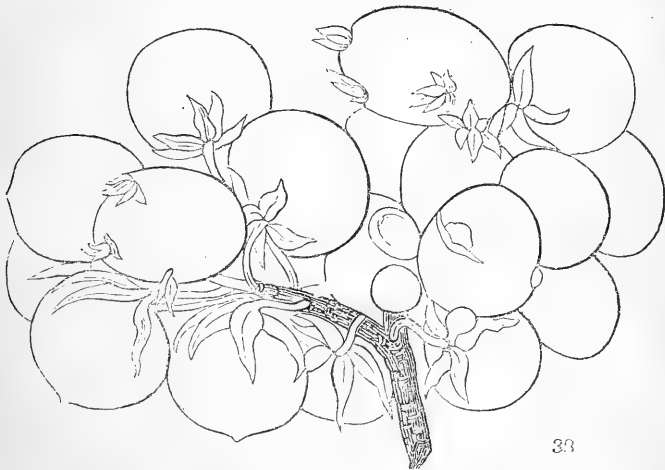
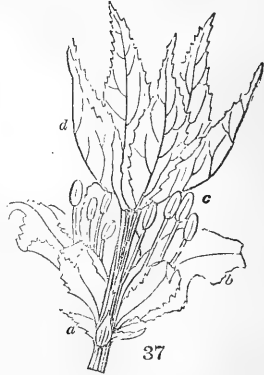
from leaves, they are each or all liable to revert to the form of ordinary leaves, if any accidental circumstance occurs to interfere with their development as floral organs. In such instances the centre of the flower will often extend itself into a branch clothed with leaves, just as a leaf-bud does, and the parts whose destination has been altered from that of floral organs to leaves will, like ordinary leaves, produce other buds in their axils.

In the case of Mr. Williams's plant the 5 sepals were unchanged, the 5 petals were converted into dull greenish purple, serrated, simple leaves, the 10 stamens remained unaltered, and the centre, which had been intended for a pistil composed of 5 carpels, was lengthened into a short branch bearing a circle of 5 ovate, dull brownish red, toothleted, hairy, glandular leaves.

The annexed cut, (*fig. 37.*) represents the appearance of one of these flowers when magnified. (*a*, the sepals; *b*, the altered petals; *c*, the stamens; *d*, the lengthened centre, surmounted by the 5 carpels changed to leaves.)

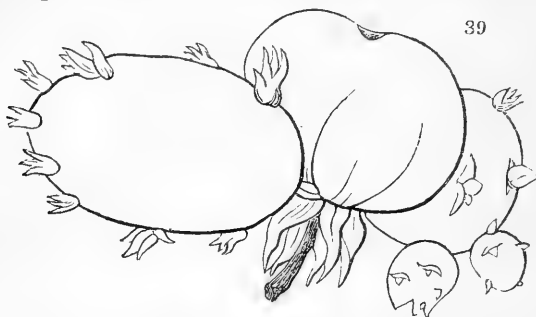
In a subsequent communication, Mr. Williams stated that, upon reexamining the plant from which the flower just described had been taken, he found an instance where a kind of pentapetaloid flower took the situation which the fruit would have found, had the structure been of the usual kind. In the centre of this flower a head had formed, and shot out, with a second similarly shaped green flower having yet another shoot from its centre, and above this a second flower, exactly resembling the first, having five stamens and anthers, with an appearance, of pollen contained in them.

It happened upon this occasion, that these singular facts were illustrated by the exhibition of a specimen of common white clover (*Trifolium repens*), in which all the parts of all the flowers were converted into green trifoliate leaves. The cases of pears, and apples, in which one fruit grows out of another, were



mentioned as other analogous instances, and reference was made to a very extraordinary malformation in the potato (*figs. 38, 39.*), specimens of which had been sent to the Society by the late president.

In this potato, while many of the flowers were perfect, and produced fruit without any thing remarkable being observed in them, others formed tubers between the fruit and the calyx, as is shown in the accompanying cuts, where *fig. 38.* represents a cluster of fruit and tubers as they appeared when growing, and *fig. 39.* a single flower, separated from the remainder, with the ripe fruit in the middle, a single tuber on one side, and on the other side a tuber itself sprouting into other tubers.



In this instance there was no alteration of position, or transformation of parts into leaves; but the floral organs, and especially the sepals, evinced the power, inherent in them as leaves, of producing in their axils buds which grew into branches in the form of tubers.

From the Society's garden, among many kinds of flowers and fruit, a specimen of *Philadelphus Gordonianus*, a new and handsome hardy shrub, sent from North-West America by the late Mr. Douglas.

The silver Knightian medal was awarded to Mr. William Cock, jun., for his very fine specimens of *Pelargonium*.

August 7. 1838. — *Ordinary Meeting.* The chairman announced that the president, His Grace the Duke of Devonshire, had had the honour of an audience with Her Majesty, who had been graciously pleased to inscribe her name in the obligation book as Patron of the Society.

A paper by Mr. Thomas Sellers was read "upon the cultivation of *Combrëtum purpureum*."

The author of this communication stated that, in the year 1834, there existed, at Mostyn Hall, near Holywell, a plant of this species, which occupied 308 superficial feet of the trellis on the back wall of a hot-house. Its shoots were trained upon wires at the distance of from 7 to 8 inches, and produced in one season 557 panicles of crimson flowers, all expanded at the same time, namely, in the month of July; from which period it continued to flower till late in the autumn, although not so abundantly as at first.

The author ascribed the healthy vigorous state of this specimen to the manner in which it was grown. It was described as occupying with its roots a chamber about 3 ft. deep, and 18 in. square, formed in the corner of a pine-pit, from which it was separated by a 4-inch wall, pigeon-holed at the bottom; within the chamber, as high as the last of the pigeon-holes, stones and brickbats were deposited, so as to insure a perfect drainage. The soil consisted of strong loam, mixed with  $\frac{1}{8}$  of rotten dung, and  $\frac{1}{12}$  of river sand, and left in a heap some time previous to using. Great importance was assigned to the drainage.

The trellis upon which the plant was trained had been gradually covered, by successively stopping the leading shoots, so that the result was a uniform distribution of branches. In the first instance a leading shoot was conducted up the trellis, over the walk which separated the bark-bed from the back wall of the house, at such a height as to leave room to pass under it. It was first stopped at the third wire on the back wall; of the vigorous side shoots subsequently produced, three were selected to cover the first three wires, and the

remainder were pinched off close to the stem. The next year the leader was again stopped, and three more lateral branches laid in; and so on till all the wires were filled. As the branches upon the wires became strong they produced shoots of various lengths; of these the stronger ones were cut back to a single eye, but such as were from 2 to 6 inches in length were preserved; and this operation was repeated every spring.

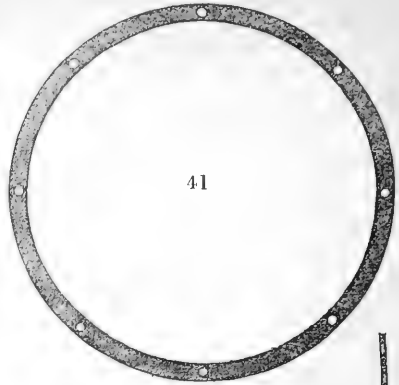
The author added that, in cultivating this plant, it is important not to disturb the roots, which find their way through the pigeon-holed sides of the chamber into the tan-pit, until they become as thick as a quill. When the tan is renewed in the autumn, such roots may be selected and coiled into small 60 pots, filled with light earth, where they are to remain till the following spring, by which time they will have firmly established themselves. At that season they may be severed from the parent plant, 3 or 4 inches in length being left above the edge of the pot, and grafted in the usual way; by which means this species may be rapidly multiplied. It is, however, necessary, in performing the operation, to leave on the scion a heel about 4 inches long, which may be inserted in a phial of water tied to the side of the pot. The graft should also be surrounded with clay, and placed under a bell-glass in a moderate heat. If the phial is regularly supplied with water as the scion consumes it, an adhesion will quickly take place with the root which forms the stock, and a young plant will be acquired.

The author added that the house in which this specimen of *Combrètum purpureum* had been trained was left uncovered from November, 1830, to February, 1834, during which time the thermometer fell to 26° Fahr. The consequence of such exposure to cold was the loss of leaves, but no further injury resulted; whence he concluded that the species need not be treated as a stove plant, but will suit a green-house, provided the wood is well ripened in the autumn.

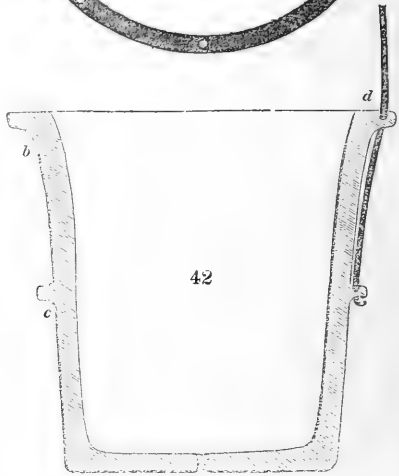
The following objects were exhibited. From Mrs. Lawrence, F.H.S., a large collection of plants, among which were specimens of *Stanhòpea oculàta*, bearing twenty-four flowers; beautiful plants of *Erica viridiflòra*, and other heaths; *Cùphea Melvìlla*, with 23 heads of scarlet and green flowers; some very fine plants of *Cràssula coccínea*; and the rare *Státice sinuàta* in great perfection. From Mr. Thomas Hogg of Paddington, a collection of carnations and picotees. From William Newbery, Esq., F. H. S., a cucumber. From James Bateman, Esq., F. H. S., a variety of *Stanhòpea insígnis*, with flowers rather larger than usual; also the spike of a new epiphyte from Oaxaca, called by its possessor *Mormòdes pardìna*. The latter specimen consisted of 17 beautiful yellow and brown flowers, which emitted a perfume resembling a mixture of pine-apple and heliotrope. From the Hon. and Rev. W. Herbert, F. H. S., a specimen of *Cymbídium crassifòlium*. Unfortunately this plant had been much injured by its journey; it, however, proved to be new to our gardens. Mr. Herbert stated that he had received it a few years since from Calcutta; that its spike was pendulous, and 3 ft. 8 in. long, with 20 large flowers, of which 17 were perfect; they appeared to have been of a brownish red, on a straw-coloured ground. From Mr. John Halliday, gardener to the Lord Sondes, F.H.S., a fine plant of *Manéttia cordifòlia*, trained to a trellis surrounding the pot in which it grew. [On applying to Mr. Halliday for a description of this pot, he, with the permission of his employer, kindly sent us one, from which we have had made the engravings, *figs.* 40, 41, 42. *Fig.* 40. is a general view of the pot with the wire framing attached; the small horizontal copper wires which serve to attach the stouter iron perpendicular wires, being only shown at the top of the figure. *Fig.* 41. is a view or plan of the upper surface or rim of the pot, showing the eight holes through which the wires are passed. *Fig.* 42. *b* shows a section of one of these rim-holes; *c*, a section of a rim projected from the side of the pot, into which the lower ends of the iron wires are inserted; *d* shows the wire inserted through the two rims, and turned up a little after it passes through the lower one. The height of the pot is 8 in.; its width at top 9 in.; the height of the



40



41



42

wire from above the pot is 2 ft. 6 in.; and its width in the widest part, 1 ft. The whole has a very neat appearance, and when covered with a plant forms a handsome object.] From Messrs. Chandler and Sons, a specimen of *Campánula frágilis*, the hairy variety, hanging over the sides of a flower-pot, and bearing upwards of a hundred of its delicate sky-blue blossoms. This plant was accompanied by a fine specimen of *Técoma jasminöides*, a most beautiful green-house climbing plant, together with a collection of dahlias and picotees. From Mr. Robert Errington, gardener to Sir Philip de Malpas Grey Egerton, Bart., M.P., F.H.S., a dish of very fine Murray nectarines. From Dr. Charles Morren, professor of botany at Liège, a specimen of the fruit of the true *Vanilla*, which he had obtained in the hot-houses belonging to the botanic garden of that town. The pod was in all respects as perfectly grown, and as highly flavoured, as the best samples imported from America. It appeared that Professor Morren had been led to the discovery of the mode of causing the *Vanilla* to bear fruit, by experiments made upon the fertilisation of *Orchidææ* in general. There are two opinions upon this subject: by some it is supposed that the contact of pollen with the stigma is not necessary in these plants, but that the influence of the pollen is communicated to the latter during the time that the pollen masses lie in the cavity of the anther, this is more particularly the opinion entertained by Mr. Francis Bauer; other botanists believe that actual contact between the pollen and stigma is necessary to produce fertilisation. It is well known that the *Orchidææ* cultivated in hot-houses, like the *Vanilla*, rarely bear their fruit, but that the

flowers drop off shortly after expansion. Professor Morren, having seen at Paris that M. Adolphe Brongniart had succeeded by artificial fertilisation in causing *Brássia maculàta* to bear fruit, undertook some similar experiments at Liège, in the course of which he obtained capsules from *Bonàtea speciosa*, *Brássia maculàta*, *Cececíades maculàta*, *Epidéndrum cochleàtum*, *Cymbídium sinéne*, four species of *Calánthe*, &c. This led him to observe the effect of applying its pollen to the stigma of *Vanilla*; and the result was the perfect maturation of a fruit, which filled the air of the hot-house with its fragrance, especially in the morning, and during the hotter part of the day. As the vanilla plant flowers in great abundance at Liège, advantage has been taken of this circumstance to convert it to commercial purposes, and it appears that the abundance of excellent fruit, which it may be made to produce, renders it of some importance in this respect in a country where vanilla is in much use. The first crop obtained in the commencement of the present year, from a single plant, consisted of 54 ripe pods, and the second crop shows signs of amounting to more than 100. Professor Morren states that the *Vanilla* thus successfully cultivated by him is *V. planifolia*, and not the *V. aromática* of the *Hortus Kewensis*. From Mr. Thomas Naylor of Brixton, flowers of picotees, carnations, and heartsease. From the Society's garden, a collection of various plants in flower, among which the *Calandrínia discolor* was particularly conspicuous. This species is hardy during the summer, when it becomes an object of great beauty in the flower-garden. It resembles *C. grandiflora*, but its flowers are four times as large, and they have the valuable property of not closing when the sun is absent; on the contrary, they remain fully expanded even in the most cloudy weather. There was also a fruit of the Trinidad Pitch Lake Pine, weighing 5 lb. 12 oz. It is known to pine-growers that this variety has the reputation of acquiring as much as 26 lb. weight in the Island of Trinidad, but there is an opinion that its quality is not good. It appeared, however, from the specimen now exhibited that its flavour is much above, rather than below, the average of pine-apples, and that it is a very valuable variety.

The following medals were awarded:—The silver Knightian to James Bateman, Esq., for *Mormodes pardina*; and to Mrs. Lawrence for her heaths. The silver Banksian to Messrs. Chandlers for *Campánula fragilis*; to Mr. Thomas Naylor for picotees; to Mr. Thomas Hogg for carnations; to Mr. Errington for his nectarines; and to Mrs. Lawrence for *Crássula coccinea*.

---

#### ART. IX. *Covent Garden Market.*

SINCE Christmas the weather has been generally open, and genial to the productions usually supplied to the market during the season. Most articles have been furnished regularly and in good condition. The prices for all green vegetables have been fairly remunerating. Onions and potatoes alone have been cheap. Asparagus and sea-kale (forced) have become articles of such general demand, that from November to May it is found in good supply. French beans have also been furnished freely. Strawberries are just beginning to appear, but as yet in very small quantities. Grapes to-day (March 22.), for the first time, have been exhibited; the price, of course, quite arbitrary. We have had, since Christmas, several parcels of green peas imported from Lisbon and Gibraltar by steam; but few of them have come to hand in good condition, consequently they have not realised very high prices: how far the taste or desire for them, at this early season, may induce further efforts to introduce them in better condition, remains to be proved; as yet they have afforded but little encouragement to those who have attempted it. The openness of the season, and the general prevalence of moisture throughout the winter, afford good prospect, if not of an early natural supply, of a general and rather abundant spring.

		From		To				From		To			
		£	s.	d.	£	s.	d.	£	s.	d.	£	s.	d.
<i>The Cabbage Tribe.</i>													
Cabbage, per dozen :													
Red	-	0	2	0	0	3	0	Endive, per score	-	0	2	0	0
Plants, or Coleworts	-	0	4	0	0	5	0	Celery, per bundle (12 to 15)	-	0	1	0	0
Savoy, per dozen	-	0	1	0	0	1	6	Small Salads, per punnet	-	0	0	2	0
Brussels Sprouts, per half sieve	-	0	1	0	0	1	6	Watercress, per dozen small bunches	-	0	0	8	0
German Greens, or Kale, per dozen	-	0	0	9	0	1	0	<i>Pot and Sweet Herbs.</i>					
Broccoli, per bunch :								Parsley, per half sieve	-	0	2	6	0
White	-	0	1	6	0	4	0	Tarragon, dried, per doz. bun.	-	0	2	0	0
Purple	-	0	1	0	0	2	0	Fennel, per dozen bunches	-	0	3	0	0
<i>Legumes.</i>													
Peas, Lisbon, per half sieve	-	0	10	0	0	12	0	Thyme, per dozen bunches	-	0	3	0	0
Kidneybeans, forced, per hundred	-	0	1	6	0	2	6	Sage, per bunch	-	0	1	0	0
<i>Tubers and Roots.</i>													
Potatoes } per ton	-	3	10	0	5	0	0	Mint, dried, per dozen bun.	-	0	1	0	0
} per cwt.	-	0	3	6	0	5	6	Peppermint, dried, per dozen bunches	-	0	1	0	0
} per bushel	-	0	1	6	0	3	0	Marjoram, dried, per dozen bunches	-	0	1	0	0
Kidney, per bushel	-	0	2	0	0	2	6	Savory, dried, per doz. bun.	-	0	1	0	0
Scotch, per bushel	-	0	1	9	0	2	0	Basil, dried, per dozen bun.	-	0	1	0	0
Jerusalem Artichokes, per half sieve	-	0	1	0	0	0	0	Rosemary, dried, per dozen bunches	-	0	3	0	0
Turnips, White, per bunch	-	0	0	2	0	0	3	Lavender, dried, per dozen bunches	-	0	3	0	0
Carrots, per bunch	-	0	0	5	0	0	6	Tansy, per dozen bunches	-	0	3	0	0
Parsneps, per dozen	-	0	0	9	0	1	3	<i>Stalks and Fruits for Tarts, Pickling, &amp;c.</i>					
Red Beet, per dozen	-	0	1	6	0	2	0	Rhubarb stalks, per bundle	-	0	1	0	0
Skirret, per bunch	-	0	1	6	0	0	0	<i>Edible Fungi and Fuci.</i>					
Scorzoner, per bundle	-	0	1	6	0	0	0	Mushrooms, per pottle	-	0	2	6	0
Salsify, per bunch	-	0	1	6	0	0	0	Morels, per pound	-	0	14	0	0
Horseradish, per bundle	-	0	1	6	0	4	6	Truffles, per pound :					
Radishes, Red, per dozen hands (24 to 30 each)	-	0	1	0	0	1	3	English	-	0	12	0	0
<i>The Spinach Tribe.</i>													
Spinach } per sieve	-	0	1	6	0	2	0	Foreign	-	0	16	0	0
} per half sieve	-	0	0	0	0	0	0	<i>Fruits.</i>					
Sorrel, per half sieve	-	0	1	0	0	2	0	Apples, Dessert, per bushel :					
<i>The Onion Tribe.</i>													
Onions :								Nonpareils	-	1	10	0	0
Old, per bushel	-	0	3	6	0	0	0	Baking	-	0	4	0	6
For pickling, per half sieve	-	0	2	0	0	3	0	American	-	1	10	0	0
When green (Ciboules), per bunch	-	0	0	5	0	0	6	Pears, Dessert, per half sieve :					
Leeks, per dozen bunches	-	0	0	9	0	1	0	Beurré de Ranz	-	0	8	0	0
Garlic, per pound	-	0	0	8	0	0	10	Easter Beurré	-	0	8	0	0
Shallots, per pound	-	0	0	10	0	1	0	Almonds, per peck	-	0	6	0	7
<i>Asparaginous Plants, Salads, &amp;c.</i>													
Asparagus, per hundred :								Cranberries, per gallon	-	0	2	0	0
Large	-	0	7	0	0	10	0	Strawberries, forced, per oz.	-	0	3	0	0
Middling	-	0	3	0	0	0	0	Chestnuts, French, per peck	-	0	3	0	0
Small	-	0	2	0	0	0	0	Pine-apples, per pound	-	0	8	0	12
Sea-kale, per punnet	-	0	1	0	0	2	0	Hot-house Grapes, per pound	-	1	10	0	2
Lettuce, per score :								Cucumbers, frame, per brace	-	0	6	0	10
Cos	-	0	1	6	0	0	0	Oranges } per dozen	-	0	0	6	0
Cabbage	-	0	0	6	0	0	0	} per hundred	-	0	3	0	12
								Bitter Oranges, per hundred	-	0	7	0	18
								Lemons } per dozen	-	0	0	6	0
								} per hundred	-	0	4	0	12
								Nuts, per bushel :					
								Brazil	-	0	12	0	0
								Barcelona	-	1	4	0	0
								Spanish	-	0	16	0	0

## ART. X. Obituary.

DIED, March 5., after a short but painful illness, *Mr. John Hunneman*, of Queen Street, Soho Square, London, in his 79th year. *Mr. Hunneman*, for more than half a century, the medium of communication between British and Continental botanists; and in that capacity he was the means of introducing many new plants to England from the Continent; and still more to the Continent from his connections in England, and his correspondence with collectors in North and South America. *Mr. Hunneman* was held in high respect by the botanists and collectors of all countries, for his probity, his assiduity in business, his obliging disposition, and his very moderate charges. It will be difficult to fill up the blank which he has left in his particular department. A papaveraceous plant resembling *Eschscholtzia* was named after *Mr. Hunneman*, some years ago, by his friend *Mr. Sweet*.

THE

# GARDENER'S MAGAZINE,

MAY, 1839.

---

## ORIGINAL COMMUNICATIONS.

ART. I. *Some Account of Gardens, and the State of Gardening, in the North and West Ridings of Yorkshire.* By J. B. W.

(Continued from Vol. XIII. p. 203.)

SEVEN or eight miles to the south of Catterick is a pretty little market town, called *Bedale*, in which there are two gardens worthy of notice, one belonging to Miss Peirse, and the other to the Rev. John Monson. Both are situated close to the town, Miss Peirse's pleasure-ground being only separated from the main street by a wall. This proximity to a large and noisy town would be extremely disagreeable; here, however, the streets are so still and quiet, that, except some extraordinary commotion is caused by the occurrence of a fair or market-day, a simple brick wall insures almost as much privacy as an intervening space of several miles between the town and the grounds would do. There is not a regular flower-garden here, nor is there any thing particularly calling for remark in the grounds; but the kitchen-garden is one of the best that I have seen in Yorkshire. It is of the usual form, a parallelogram; well sheltered on the north and east sides, and on the west there is a thriving young orchard. The soil is excellent, as is proved by the luxuriance of the vegetables it produces, and by the magnitude and fruitfulness of the trees.

One west wall is covered with remarkably fine fan-trained pear trees, chiefly of the old varieties, which generally bear profusely: among them is a Gansell's bergamot, extending upwards of 60 ft. in breadth, by 12 ft. in height. Two standard trees of the Aston Town bear and mature their fruit well: in 1835 their produce was estimated at thirty bushels. This valuable variety ought to be in every garden; when in perfection its flavour is delicious; and it is so hardy as to thrive well as a standard tree in this northern climate. A pear called the "rose-water," which I never saw elsewhere, is grown here. It is a middle-sized obovate fruit, with buttery flesh, and a flavour resembling that of the swan's egg; it ripens in the beginning of October,

and will not keep longer than a few days, decaying at the core when the exterior seems sound.

One great fault in the arrangement of this garden is, that the melon-ground is placed in the middle of the kitchen-garden, separated, however, by hedges from the body of the ground. Cucumbers and melons are principally grown in pits originally used for the cultivation of the pine-apple. One of these pits has lately been transformed into a peach-house, by planting the trees on the outside, and introducing their stems through the front wall; and, as the trees are trained upon a wire trellis close beneath the glass, first-rate fruit might reasonably be expected. The hot-houses consist of three vineries, in which I have sometimes seen very superior grapes.

The gardener, Mr. Hewson, is an ardent florist, cultivating with considerable success most of the fashionable flowers of the day.

At Mr. Monson's the flower-garden is the only department worthy of notice. It is a gently sloping lawn, thickly studded with flower-beds of various forms and sizes, in which such plants as dahlias, calceolarias, fuchsias, &c., make a fine display in summer and autumn. Iron framework, not of the most tasteful designs, is placed here and there upon the lawn, for the support of twining plants. Several large bushes of *Buddlea globosa* formerly stood upon the turf, and, when covered with their golden balls of honeycomb-like blossoms, they were beautiful objects; the last winter, however, destroyed them, or at least they were killed to the ground. The only glass structure at this place is a small but pretty green-house, standing against the end of the dwelling-house, and communicating with the rooms. It contains only common plants; and I notice it merely for the sake of recommending, as an admirable trellis plant, the *Heliotropium peruvianum*, which, trained to a trellis at the back of this house, grows luxuriantly, and fills the whole place with its delicious fragrance.

*Newton le Willows* is a retired village, within a short distance of Bedale, at which a gentleman named Forster, or Foster, has built a neat mansion, and formed a miniature garden, on a piece of ground which previously was a boggy waste, close to the public road. Apparently, the house and its appendages, with the kitchen and flower-gardens, do not occupy much more than an acre of ground; and yet, in this circumscribed space, it has been attempted to display both the geometric and the modern styles of gardening, including, likewise, an American ground, shrubbery, rockwork, fountain, moss-house, and other garden ornaments. Considerable skill is shown in the disposition of the various parts; but, viewed as a whole, the effect is puerile, owing, evidently, to too much having been attempted. Little



fault, however, can be found with the practical management of the plant department, which, in the summer season, is gay with choice and showy flowers.

All the beds that are upon the turf have movable edgings of strong iron wire, that, so far as I can discover, answer no earthly purpose except to make work, as they are to be taken up and put down again every time the grass is mown. I have often seen similar contrivances at other places, and as often have asked myself, Why are they there? always, however, without stumbling upon a satisfactory reason. Luxuriant trailing plants, such as petunias and the strong-growing species of *Verbena*, which generally overrun the limits of their beds, and therefore require restriction, may with some justice be put in irons; but, for beds of miscellaneous plants standing upon a lawn, the turf is a sufficient, and the most appropriate, edging. A Lilliputian green-house is attached to the mansion: it is prettily designed, and very expensively executed; in fact, the money that must have been laid out upon this diminutive demesne would have been amply sufficient, under a judicious system of expenditure, for the formation of a garden twice the size, and of much greater real beauty.

I observed here Myatt's pine strawberry, growing and bearing better than I ever saw it before: the plants stood in a warm dry situation, and the fruit was abundant and exquisitely flavoured.

*Thorp Perrow*, a mansion two miles to the south of Bedale, is the property of Mark Milbank, Esq. The house is a large, handsome, stone building, with three fronts, of which that to the south is the principal. Although the country hereabouts is not rich, the house is rather pleasantly situated in a park-like meadow, and near a pretty sheet of water. The Hamilton hills are seen to the east, over a wide tract of level country, and on the south, not far from the house, is the ruin of Snape Castle. The west end of the mansion contains an elegant saloon, from which a bow-window opens upon a wide gravel walk, leading across the flower-garden to the pond: each side of this walk is ornamented with a row of stone vases, mounted on disproportionately large pedestals. The flower-garden is capable of great improvement; indeed, in its present state, it scarcely deserves that name, as there are very few plants in it, and those not of any value. The kitchen-garden is only third-rate; it, however, contains several roomy hot-houses, in which there are some of the finest young vines I have lately seen. Several of the grapes sold by the late Mr. Daniel Money as new sorts have fruited here; and, having had an opportunity of examining the fruit, I am thereby enabled to give an opinion of their merits. I understand that the vines were procured direct from Money, therefore it may be presumed that they are true to his names. The

“Muscat Eshcollata” appears to me to be nothing more than the white muscat of Alexandria, which in the north is commonly called the white Tokay. Fruit from Money’s vine was carefully compared with the white muscat growing in the same house, and the only perceptible difference was, a slightly deeper shade of yellow in the former, which most likely was the result of accident, and not a permanent character; for the fruit, foliage, and wood of both vines agreed perfectly in every other respect. Or, even if Money’s muscat is a seedling which, from its hardier habit, ripens its fruit a few days earlier than the white muscat, still the difference between them is so exceedingly slight, that the former cannot with justice be considered and sold as a distinct variety. The “Eshcollata superba” is a large, oval, fleshy grape, somewhat resembling, both in foliage and fruit, a sort I have seen under the name of black raisin: possibly it may prove identical with the red muscadel. “Money’s West’s Saint Peter’s” is the same grape as the one sold by him under the name of “Raisin des Carmes.” Its berries are large and oval-shaped; the skin is thin, of a deep dull red colour, like an imperfectly coloured Hamburg, and sometimes slightly mottled with green. I have only seen this grape in late vineries, where its merits could not be fairly developed; yet I can confidently recommend it as a valuable sort for a warm vinery, in which situation its colour would probably be a better black. The extreme (for a grape of its size) thinness of the skin sometimes causes the berries to burst, if the atmosphere of the house is moist. “Oldaker’s West’s St. Peter’s” grape, although it has the same family name, bears no relationship to the preceding sort, but is distantly allied to the Black Prince, from which it differs in the bunches being shorter and much more shouldered, and in the berries being rather smaller and of a more dead black: in flavour, too, Oldaker’s grape is sharper than the Black Prince, and in the same temperature it ripens ten days or a fortnight later.

With all due deference to your superior knowledge in such matters, I take the liberty of telling you that the names Money’s West’s Saint Peter’s, and Oldaker’s West’s Saint Peter’s, as applied by you in a former volume of this Magazine to those two varieties of grape, are highly absurd. If Money’s account of the origin of this grape is correct, it ought to have been called “West’s seedling,” even although its presumed originator, West, had named it “Saint Peter’s,” because undoubtedly this last name had been previously applied to another grape. The fact of this grape being known by a foreign name (raisin des Carmes) leads me to suspect that it is not an English seedling, but an imported variety; and it is not unlikely that raisin des Carmes will eventually be found to be its true name.

ART. II. *Remarks on the Charges made by Landscape-Gardeners and Garden Architects.* By the CONDUCTOR.

HAVING lately, with very great reluctance, consented to act as arbitrator in the case of the employer of a landscape-gardener having thought the bill given in by the latter exorbitantly high, it occurs to us that it might be useful to make a few remarks on the subject; the object of which will be, to prevent misunderstandings of this kind between professional men and their employers.

In general, when there is a disputed point between a landscape-gardener or garden architect and his employer, respecting the bill of the former, it is on account of the charges made for his plans, drawings, estimates, or reports. If a principle can be established on which these are to be charged, much of the difficulty in the case of an arbitration will be got over; and this principle, once made known and disseminated, will be a guide to landscape-gardeners as to what they ought to charge, and to employers as to what they may expect to have to pay, when they employ this class of professional men. In noticing this subject in the *Suburban Gardener*, p. 479., we stated the principle to be the value which the professional man set on his time, charging at the same rate for the time occupied in making the plans, &c., as for that employed in going over the ground. The charge of landscape-gardeners varies from one guinea to five guineas a day, for the time employed on the estate, or consumed in going to the place to be laid out, or in returning from it home. To this charge per day is, of course, added all reasonable travelling expenses, whether by coach or postchaise; and also those of board and lodging while the landscape-gardener is employed on the grounds; unless, as is generally the case, he lives with the family. Where a landscape-gardener charges five guineas a day, and takes with him either a draughtsman or valet, or both, he is entitled to travel in a postchaise; but in ordinary cases, and where the charge is under five guineas a day, the usual charge for travelling is by coach. If a landscape-gardener travels in his own carriage, and with his own horses, then if his charge is under five guineas a day, he charges for travelling expenses, as if he went by coach; but if he charges for his time at the rate of five guineas a day, or upwards, then his travelling charges are made as if he went by post. In both cases, however, the time charged for must not be that actually taken when a man travels with his own horses, but the time which would be required to perform the journey by the mail, or by a postchaise. In cases where a landscape-gardener is on a professional tour, or where he travels to a distant part of the country at the request of two or three parties intending to employ him, the travelling expenses are divided, in proportions depending on distance and other circumstances; the understanding being that no more shall be charged than the money out of pocket (or that would be out of pocket by coach or by post), and the value of time at the landscape-gardener's fixed rate of charging per day.

The value of the landscape-gardener's time being determined by his charge per day, the next point is to determine what a professional day is. Now, as every professional man must be considered as in the rank of a gentleman, and, while he is employed in the grounds, as having a place at the table of his employer, it is sufficiently evident that his day will consist of the time which elapses between breakfast and dinner. If the professional man chooses to walk out before breakfast, or to occupy himself in writing or drawing in his room in the evening, he may do so; but we by no means consider that he is bound to employ himself at these periods as a part of his day; though, if his heart is in the proposed improvements, he will most likely do so. The day, then, of a landscape-gardener we shall suppose to commence one hour after breakfast is finished, and continue till one hour before dinner is commenced; or, in other words, from eleven till five o'clock, say six hours, or between six and seven hours.

While we fix on six or seven hours, as the day of a landscape-gardener, we consider it proper to state that it is customary, when the nature of the employment admits it, for the artist to employ himself in the evening in contriving his plans; but it is understood also that he is entitled to do this, if he chooses, in the day time. It very frequently happens that a landscape-gardener is called in simply for the purpose of staking out plantations, walks, or roads, and that no plan, writing, or drawing, is at all necessary; and, of course, there can be nothing for him to do in the evening, even if he were disposed to occupy that time for the benefit of his employer. This circumstance of itself shows the reasonableness of limiting the duties of the landscape-gardener to the time when he can be employed out of doors; for, otherwise, if he were merely called in to mark out improvements on the ground, as he could not in that case be employed in the evening, his employer might allege that he did not give a full day.

Having determined the time required to constitute a landscape-gardener's day, the next point is to estimate the portion of this time, or, in other words, the number of days, which he employs, or is entitled to employ, on plans, drawings, reports, or estimates, made at home. It is customary to make certain plans or drawings for effect; that is, in order to give the proprietor an idea of the appearance which the improvement will have when completed; and certain other plans or drawings, called working-drawings, to serve as guides while the work is going forward. Now, the contrivance of these drawings, and sometimes even the drawing of them, requires to be done by the landscape-gardener himself; but there are certain other parts which may be copied, or even completed, when once properly begun, by a clerk, or assistant draughtsman; while reports, estimates, &c., after being drawn up and corrected by the professional man, may be copied by clerks. It appears, therefore, that two elements enter into the charge which a landscape-gardener may make for plans, estimates, &c.; viz., one for the time of the master, and another for that of his draughtsman or clerk. Whatever may be the charge of the master, the time for the assistant draughtsman and clerk is generally charged at the rate of a guinea a day, with the addition of all expenses while he is from home, or employed out of the office. This, of course, supposes the clerk to be a competent draughtsman, and master of the routine of business of a landscape-gardener's office. It sometimes happens, for example, that an assistant is sent down into the country to stake out a plan on the ground, or to make a map of some particular spot, and give a description of it to the landscape-gardener; and in such cases the charges are made as we have just mentioned.

The fundamental principle for charging for a landscape-gardener's plans, therefore, is, the value at which he estimates his time, controlled by the subordinate principle of the value of the time occupied on the plans by his assistant, or any draughtsman whom he may think fit to employ.

Having established what we consider to be the sound principle for charging for plans, reports, &c., we shall next state some deviations from this principle which occur in actual practice.

In Scotland, where the charge of landscape-gardeners, forty years ago, seldom exceeded a guinea a day, except for such artists as Mr. Nasmyth, the eminent landscape-painter, who charged two guineas a day, it was customary to charge double the price per day for the time employed on plans. We have never heard any reason assigned for this; but we suppose it may have arisen from an idea on the part of the landscape-gardener, or planner, as he is there called, that the act of drawing a plan indicated a higher degree of talent, or was a more intellectual occupation, than the staking out of improvements on the grounds. Or, perhaps, the greater charge made for the plans was intended to make up for the low charge by the day. In either case, we think, the principle is erroneous; but, if the employer is aware of it beforehand, of course it is to him unobjectionable.

Some landscape-gardeners have no charge per day; but, when they are employed, they give in a plan; or, if they have been merely called in to stake out

improvements, they draw up a report, for which they make a charge, according to the supposed ability and willingness of the employer to pay. However common this mode of charging may be, both among professional men and tradesmen, it is very unjust in principle. The richest man should not be charged more for any description of object than the poorest.

Some landscape-gardeners purposely charge a very low price per day, in hopes of getting employment, and of making it up by a high charge for plans, and by getting a per-centage from the nurserymen, or other tradesmen, who are employed to execute the work. This is also a very unfair mode, and, like the other, frequently leads to disputes. No professional man ought to receive any per-centage from a tradesman, under any circumstances whatever.

Both in England and Scotland, it is customary for nurserymen to give plans for laying out grounds, building garden structures, &c.; and as, in such cases, they generally get the work to execute, the plans are not charged for. In other cases, a regular charge is made by the nurseryman for his time, say at the rate of one, two, or three guineas a day; and the party for whom the plan is made is at liberty to have it executed by whom he chooses. If he employs the nurseryman who made the plan to execute the whole, the charges for the plan, time, examining the grounds, &c., are deducted from the account for executing the work; and if he is only employed to execute a part of the plan, then only a proportionate part of the expense of making it is deducted.

There is a branch of landscape-gardening which is, to that profession, what building is to architecture, and is called new ground work; and the undertaker of it is called a new ground workman. This department is chiefly of a mechanical nature, and consists in carrying plans into execution, more especially in cases where there is much ground to remove, as in forming pieces of water, new kitchen-gardens, &c. The persons who undertake this department frequently make plans, and charge for them on the same principle as nurserymen do, deducting the whole or part of the charge, as they may execute the whole or part of the work. The celebrated Mr. Brown acted both as landscape-gardener and new ground workman; but Mr. Repton only in the former capacity.

Some professional men have a regular charge per day while employed on the grounds; and, after having acquired on the spot all the information necessary to enable them to make such a plan as they consider necessary, they agree beforehand with the proprietor to make this plan for a certain sum. This is a very commendable mode, as tending to prevent surprise on the part of the employer, who may know nothing of the usual charges for plans; and, consequently, when that charge amounts to more than he had any idea of, very disagreeable consequences to both parties must necessarily ensue.

Some landscape-gardeners, after charging for their plans, &c., undertake to see the work executed under the direction of a foreman, either for so much for the entire work, for so much a year while it lasts, or for their usual charge per day for the time occupied in making professional visits, while the work is going on, corresponding with the foreman, examining his accounts, &c. Some, instead of charging a certain sum per day for superintending the execution of the work, charge a per-centage in the manner of architects; but this we consider an objectionable mode, since the remuneration bears no necessary relation to the talent employed; and as to the idea of available responsibility, unless the professional man finds actual securities, men of property, his individual security is of no practical value. Even architects are now very seldom remunerated by a per-centage, but generally by a fixed sum, or so much a year while their plans are being executed.

It has been objected to the mode of charging by the day, that it puts the professional man on a footing with the common labourer; and those landscape-gardeners who are of this opinion, when consulted, make known previously what they will charge for a professional visit of a certain time, including whatever sketches they may make, or written directions which they may prepare, during that time; and if there should be any other plans required which the

artist can do at home, he agrees to do them for a certain sum. This mode of doing business was ultimately adopted by the late eminent Mr. Repton, though he commenced, we believe, by charging by the day, at the rate of five guineas, with travelling expenses in a postchaise, taking with him his valet.

Between thirty and forty years ago, the most eminent architects, such as Mr. Nash, Mr. Wyatt, &c., seldom made a professional visit in the country under a hundred guineas, travelling expenses included; while the charges of these gentlemen for plans frequently amounted to several hundred pounds, and, we have heard it said, occasionally to upwards of a thousand pounds. Mr. Wyatt's charge, when consulted in his own house, we have heard it said, was ten guineas an hour. Competition, and the increased value of money since 1814, have, however, now rendered the charges of architects and landscape-gardeners much more moderate than formerly; greatly, as we think, advancement of the arts which they profess, and to the benefit of the public at large.

We shall conclude this article by an extract from the *Suburban Gardener*, and by one also from the *Architectural Magazine*, for the sake of showing that the above opinions are not newly taken up on our part, but that we have held them for seven years; and also that they are held by others as well as ourselves.

“As we have strongly recommended professional men to be consulted previously not only to building and planting, but even to purchasing a property for the purpose of forming a residence, it may be useful to give some idea of the charges which surveyors, architects, and landscape-gardeners make for giving their advice. An opinion, or a visit, may be obtained at from one to five guineas, according to the reputation of the party employed; exclusive of travelling expenses, if the artist should be required to leave his home to look at the premises. If, after seeing the grounds, or the house, or both, he finds it necessary to make a written report, the charge for that report would be one, two, or three fces more; that is, at the utmost, from three to fifteen guineas. If plans are to be made, the charge will depend on their nature and extent; always bearing in mind that the difference in the price charged for plans is as different as the price charged for single visits; and that the general rule by which the artist charges for his plans or his reports is, the time which he is occupied in making them. Hence, a plan or report, from an artist whose charge is five guineas a day, would cost five times as much as the same plan or report from an artist who charged a guinea a day. It was formerly the general custom for architects, and it is still so in a considerable degree, instead of charging for their plans, to charge a per-centage on the amount of the work done, as a remuneration both for the plans and for superintending their execution: but this may truly be called an absurd mode of remuneration, since it implies no available responsibility on the part of the architect, and it makes no distinction between the skill required for the designs and working-drawings of the most elaborate mansion or villa, and the merest accumulation of bricks and mortar, in a manufactory or barracks; and, at the same time that it overpays the architect for a palace or church, it does not pay him adequately for a cottage. It used also to be the custom formerly for the architect not only to receive a per-centage from his employer, but also another per-centage from the builder, or the different tradesmen employed in executing the work from his plans; so that, instead of 5 per cent, the nominal remuneration usually paid by the employer to the architect, he was often in the actual receipt of 10 or 15 per cent. These extravagant and anomalous charges formed one of the causes which have led to the establishment of large building companies, who at once give designs, and carry their plans into execution, by contract; not only without charging any per-centage, but at the risk of loss (which is serious, they having a real capital to lose), if they should have deceived themselves in forming their estimates. The large sums paid to architects, in consequence of the mode of remunerating them by a commission on the amount of the work, form one of the grand causes which have led to the retardation of

architecture in Britain. It has deterred persons from employing regular architects, and either prevented them from building and improving at all, or compelled them to have recourse to builders, carpenters, and persons of inferior taste and knowledge. At the present time, when this kind of monopoly has been partly broken up, and architects, in many instances, charge by the day, or at so much per job, twenty are employed for one that was consulted thirty years ago, and a proportionate number of handsome buildings have been erected all over the country. We certainly would not employ a builder to make a design for anything we intended to erect, however eminent he might be as such; because the designs from such a source, being generally prepared in a routine manner in the builder's office, are frequently monotonous, and of little value with reference to the taste displayed. We would employ an architect whom we believed to be a man of genius; pay him handsomely for his designs; and have them carried into execution, under his occasional inspection, by a first-rate builder." (*Sub. Gard.*, p. 480.)

"Some architects deceive their employers, by making very pretty and attractive drawings, and reporting that the expense of carrying these into execution will be about half or two thirds of what it actually turns out to be. In this way they obtain the sanction of their employer to commence building; and, when the accounts are sent in, the employer finds himself involved, too frequently, in ruinous expenses. The builder, in such cases, often gets into disgrace, and is either obliged to commence an action to obtain his rights (because the architect has the knavery, in order to screen his ignorance, to say that the builder's bill is a most exorbitant one), or to have his bill cut down so low, that he is left a loser instead of a gainer, after labouring hard for twelve or eighteen months. To remedy this evil, I would advise the parties intending to build, to contract with the architect for his commission, as well as with the builder for his work. This might be done in the following manner:—If the architect reports that the building will amount to 2000*l.*, his commission should be fixed at 100*l.*; and, if the work exceed five per cent beyond his report, it should be arranged that there should be a deduction from his commission of five per cent on the excess of the amount beyond the original estimate. Thus, if the original estimate were 2000*l.*, and the actual cost 2500*l.*, the commission of the architect, instead of being 125*l.*, as it would be by the present custom, would be only 75*l.*; whereas, had the amount been within 2100*l.*, his commission would have been 100*l.* By thus reducing the architect's commission, instead of increasing it, when the expense exceeds the estimate, as is now the practice, the temptation to give in false estimates would be diminished; though these estimates are likely to be often made, as long as the inducement is so strong as it is at present.

"Another very paltry trick, common among some architects, is their custom of exacting from the builder a commission for all works done under their direction; and, if this be refused, informing the builder that his services are no longer required." (*Arch. Mag.*, vol. i. p. 16.)

When a gentleman has a dispute with his builder, and each party calls in a surveyor to settle the difference between them, the usual mode of proceeding in London, at least a few years ago, is very well described in the following passages:—

"The first thing I shall notice is that disgraceful mode of giving evidence in courts of justice, which has made the very name of a surveyor a laughing-stock for the legal profession; his evidence in a court of law is looked upon in the same light as that of a horse-jockey in a horse cause; and can we be surprised at it, when similar evidence to the following is constantly given?

"Plaintiff A and defendant B are at issue upon an account for works executed. The witnesses of A state that the work is done in a very superior manner. One witness swears that the work is fairly worth 1,544*l.*; and another witness, to support him, swears the fair value is 1,630*l.* Then come the defendant's witnesses, who state that the work is very badly executed, and done in a very improper manner. One of them asserts that the outside value of the

plaintiff's work is 930*l.*, and another surveyor says he makes the value 935*l.* Now, what are the judge and jury, who know no more about a building account than a boy of seven years old, to do in such a case? They are surprised and astonished that respectable men can be so very wide in their values; and what is the result? Why, they take the several amounts as given in evidence, add them together, and divide the amount by the number of witnesses. Accordingly, the result in the above case would be, that a verdict would be given for 1,257*l.*

“Now, let architects and surveyors reflect upon this disgraceful mode of giving evidence (and they know too well that what I have stated is pretty near the truth), and ask themselves whether it is not time that something should be done to redeem the character of their profession?”

“Again, do we not find it frequently the case, that gentlemen have such an antipathy to the name of a surveyor, that, if a builder were to mention to his employer that he was about to engage a surveyor to measure the works executed, he would immediately give offence; consequently, the builder is obliged to introduce the surveyor into the building by stealth. Nor can any one be surprised at it, when they witness the extortionate charges made by some surveyors, whom I shall here style custom surveyors. This is the manner in which they proceed:—Two surveyors meet to make out an account of certain works done. We will suppose the account that they have to settle is a plumber's bill. The first article is 18*s.* per cwt. of milled lead: the plumber's surveyor requires 25*s.* per cwt.; the surveyor for the opposite party remonstrates, and points out to him that the prime cost was 15*s.*; the other replies that 25*s.* is the customary price, and that he cannot take less. To convince his opponent, he opens an old measuring-book, and shows that 25*s.* have been charged in an account that he settled on behalf of Mrs. Getall, with Mr. Easy, the surveyor, some years before; and he again repeats, that it is the custom to charge 25*s.*, and that he cannot deviate from it. In the same way, he charges 1*s.* per foot for pipe that only costs 4*d.*; and 1*s.* per lb. for solder that only costs 5*d.*; and so he goes on, in the same ratio, with all other articles in the bill. After charging so extortionately for the time and materials for making a joint to a pipe, he has the conscience to ask, in addition, 2*s.* 6*d.* for that joint, though he cannot tell why he does so, except that it is the custom, &c. The consequence of all this is, that the surveyor for the opposite party, if he has any conscience, cannot settle the account, and it is referred to the lawyers; it is then carried into a court of justice, where it is decided in a similar manner to that which I have before described.

“As a remedy, I would recommend every person intending to build, to have the work done by contract. I would contract even for a dog-kennel.

“Another great error in valuing builders' work is, that the surveyors too frequently charge but one price, whether the work be done well or ill, and that they pay no regard to the prime cost, or to the mode of payment. The latter ought to be taken into serious consideration; for, if the work be paid for as it proceeds, it will enable the builder to purchase his materials with cash, and thus generally 10 per cent cheaper in the market than if he had to obtain them on credit. On the other hand, if the work be not paid for till some time after it is finished, a considerable increase ought to be allowed, for the disadvantages of being obliged to purchase on credit, and for the use of the ready money necessarily laid out in workmen's wages. Something, also, should be allowed for risk, as builders are liable to have bad debts as well as other tradesmen.” (*Arch. Mag.*, vol. i. p. 15.)

The great object which we have in view in preparing this article is, if possible, to prevent disputes between landscape-gardeners and their employers. For this purpose we have stated the various modes in which charges are made; and, in conclusion, we think that, in general, a fixed charge per day, and a previous agreement for the amount to be paid for the plans, estimates, reports, &c., in every particular case, are likely to be the most satisfactory to both parties.



ART. III. *On acclimatising Plants in British Gardens.*

By N. M. T.

THE accounts of the half-hardy plants that have been killed by the severity of last winter are so contradictory, that I question whether they have advanced our knowledge a single step, as to the grand question of acclimatising. But they prove, however reluctant we may be to admit the fact, that all our past endeavours have availed us nothing. And now that we are compelled to make a fresh start, it is a fit opportunity to adopt some principle as a guide to our operations; as the worst principle, so adopted, cannot produce more unsatisfactory results than the numberless systems that have been so completely swept away. As past events have so fully verified the opinions I previously expressed, regarding the protection generally afforded to such plants, &c., I beg to offer a few farther remarks upon the subject. From the ample accounts alluded to, it appears that plants growing in poor soil, and the most exposed situations, have invariably suffered less than those growing in the most sheltered places; and that plants protected have been killed, while the exposed ones remained unhurt. These facts may be at variance with most of our preconceived notions, but are important, as they point to the rest of the evil: for, if the same cause produce different effects in plants of the same species, it is evident that the cause of the difference must exist in the plants themselves. Plants have stood best in exposed situations; but it does not follow that they prefer such situations, or that they would have suffered more had the cold been less: on the contrary, had the plant sheltered been in the same condition as the one exposed, it would undoubtedly have suffered less than the one exposed; and, although premature covering be the certain cause of death, still nothing can be more beneficial when not applied until wanted.

Professors disagree about the method by which frost causes the death of plants; and, as I cannot enter scientifically upon the subject, I am compelled to adopt the maxim, that "seeing is believing," and shall presume that death is caused by a mere mechanical operation. Every one knows that receptacles filled with matter must become lacerated, should the matter they contain be expanded beyond their powers of expansion or resistance. This is an incontrovertible law; and that plants are subject to it, and that many of them are so destroyed, we have abundant proof; nor is it sufficient reason to assign a different mode of attack in other cases, merely because the operation is carried on upon a scale too minute for our perception. This being assumed as fact, it follows that the hardiness of any plant depends entirely upon the quantity of sap that it contains, and on the resistance

that it is capable of offering at the time of the matter contained in it becoming frozen. Hence it follows, that a plant in a growing state, with its tissue fully distended, must be a certain victim, however hardy its nature; while one more tender, in a dormant state, or with its juices drained, will resist an unexpected degree of cold. This satisfactorily explains the otherwise inexplicable escapes that plants sometimes experience; and perfectly accounts for the little dependence that can be placed upon original climate. This principle of reducing the sap of plants is neither understood nor acknowledged by many gardeners, who, nevertheless, without knowing what they are doing, give their cabbages the full benefit of it. Many valuable varieties of the *Brássica* tribe cannot stand our winters, until they have been *laid*, as the operation of disrooting is termed; or until their roots have been cut, the supply of sap shortened, and the juices of the plant wasted by respiration, until it becomes flaccid, retaining enough to support life, but not enough, when expanded, to destroy it.

This is a very simple operation, and may be considered a very unmeaning example in the present case; but simple as the operation is, or whatever may be the reasons assigned for its performance, the result is most important; as, by it were a single stroke of the spade, a tender, or at least a very doubtful, plant has been rendered perfectly hardy. And why should a practice so satisfactory in its results be confined to a single tribe, when its influence may reasonably be supposed to extend to the whole vegetable creation? That its influence does extend to many others we have abundant proof, as growing plants in poor soil, keeping others extremely dry, and many other expedients that we resort to, to produce the same effect, are mere modifications of the same system.

All these expedients tend to the reduction of the sap; and, according as we succeed in effecting this, so are our endeavours crowned with success. The plant growing in poor soil is not actually disrooted; the scanty supply its site at all times affords renders this operation unnecessary, and perhaps unbearable; it naturally produces scanty, elastic, and comparatively sapless roots, while it offers no inducement to luxuriant growth, or premature vegetation; the bane of most turned out exotics. Disrooting plants placed in more favoured circumstances would cause them to produce fibre, possessing all the requisite qualities, and fit to commence their growth at the proper season. In short, we should have plants capable of all the endurance of the former, and enjoying all the benefits of the latter situation. To what extent disrooting may be carried, at what time performed, and how far exotics are to be benefited by it, can only be ascertained by experience; but it may be presumed that it ought always to

be done in time to prevent the plants from growing in winter, and to reduce them to the lowest state, consistent with their safety, before the commencement of frost.

Upon this power of conforming themselves to the seasons must, in a great measure, depend the hardiness of all kinds of plants. Many, even natives of our own hills, owe their safety entirely to the absence of sap at such a season; if forced unseasonably into leaf, and exposed, they would be found as susceptible of injury as the tenderest exotics. Escape, in such a condition, is, in fact, an impossibility, and would be a direct violation of infrangible laws, to which even the monarch of the wood (when caught in this condition) has been compelled to bow his head in submission.

How unreasonable, then, to suppose exotics capable of offering effectual resistance, placed in the very same circumstances! Absurd as this proposal may appear, as it can hardly be said to cause either extra trouble or expense, I hope that all of your readers who feel interested in the subject will give it a trial; the result of the experiment will soon be ascertained; and, if by it one degree of hardihood is obtained, it will amply repay the experimenter, whose only care must be to train his plants into a proper condition to bear cold, and not to apply any covering till it is wanted.

When speaking of covering, I cannot help remarking that many fine specimens in the superb American ground of the Venerable Archdeacon Croft, at Saltwood, near Hythe, are covered with a sort of baskets that I consider superior to those figured in p. 44. Their superiority consists in the top part being made to take off like the top of a hand-glass; the tops are thus removed in fine weather, to admit plenty of light and air. They are formed of the same materials as those figured, and were constructed under the directions of Mr. Acombs, gardener to the archdeacon. These are probably the very best sort of covering in present use; and as shelters from the wind, or protectors in spring, they are all that can be wished: but winter covers for plants can never be of service, unless they defend them from rain. This the variableness of our climate renders imperatively necessary. The night of the 29th January, when rain fell in torrents, and in a few hours the temperature was reduced to 20°, is a striking example of this necessity. Plants in this case, fully exposed, might have the wet shaken from them, but those covered must have been encased in ice. Snow, too, lodges upon them, and melts in sunshine, while the interior is freezing; and, under such circumstances, the plants that we suppose to be enjoying protection are being watered overhead. Hence, if the movable tops of these baskets were covered with any cheap waterproof material, or formed of boards, tin, or zinc, they would be incom-

parably better suited to the purpose. Among the many proofs of the injurious tendency of covers, in their present state, I may mention a fine plant of the *Rhododendron Smithii*, in the collection above named, that was killed to the ground; while a *layer*, that could not be included in the basket, had not a leaf injured.

This case might also be adduced as an example in favour of the system I have advocated in this paper, if we suppose that the covering drew an undue share of sap into the part covered, leaving the layer a scanty supply, and consequently better able to resist the cold.

*Folkstone, Feb. 1. 1839.*

---

ART. IV. *On the Use of a new Kind of Wire Netting, for various Purposes, in Gardening and Planting, &c.* By S. T.

SOME time after the completion of my garden, I was grievously annoyed by hares and rabbits, sad enemies, as you are aware, to flowers and young plants in general. They began to bark my apple trees, and I barked at them in return, but the deuce a bit could I bite. At last chance threw in my way a piece of wire netting; and by and with the assistance of a friend in the neighbourhood of Swaffham, who for the last ten years has made and used them for sheepfolds (he has 1000 yards in constant use), I have put my gardener in the way of manufacturing them; and it enables his family at all times, and himself at an "orra hour," when work is dead, as in sharp frosts or deep snows, to turn many an hour to good account, which would otherwise be unemployed, or at all events not profitably employed. To return to my garden. It is surrounded by a clipped whitethorn fence, not game-proof, as you may suppose; especially when I tell you it is weak in places. On the outside of this fence I have hung my wire net; and though two years have elapsed, and we have had some tolerably sharp weather, I have never been troubled with either hare or rabbit since. But how does it look? you will ask. It does not look at all; for you may stand within two yards of it, and no one, that was not in the secret, could tell that there was any other than the whitethorn fence. I clip over it, and there it remains in the hedge, as effectually guarding against depredation as if it were a clumsy unsightly wall. Observe, I took care to peg it carefully down to the bank; and well, I must needs say, it answers the purpose. The dimensions of this net are as follows: 21 in. deep, and each mesh rather more than  $2\frac{1}{2}$  in. square — say, 8 meshes in the 21 in. Several, who saw it before it was put down, expressed doubts as to whether young rabbits would not make their way through. For my own part, I had no fears on the subject, and the result has proved I was

correct. Still, as it might be wanted where the live fence was not quite so good, even, as my own, or perhaps where there was *no* live fence at all to attach it to, I was resolved henceforward to go on the safe side, and make the future garden nets 24 in. deep, and 10 meshes in that space, instead of 8 meshes in 21 in. of depth. I send them out ready oiled and painted; for which I have a machine, which performs that operation very effectually and expeditiously; and, as employment is the principal object, the very lowest price is put on them. The first opportunity I have, I will send you, by way of specimen, a yard of each size we have hitherto made. Another sort we furnish is the sheep-fold net, a most useful article in any situation, but particularly in a game country, where they are infinitely preferable to the tar-rope nets so much in vogue of late years. The objection to these latter is, their liability to decay; but, long before this takes place, to destruction from gnawing by hares. There is something in the wire nets, be the meshes as large as they may, which neither hares nor rabbits like to venture near: I suppose they appear to them too much like traps or snares. The sheep nets are of a stouter wire than those for gardens, 3 ft. deep, and  $4\frac{1}{2}$  in. square in the meshes, or 8 meshes in the depth. The cost is little more than common wattled hurdles; their duration, with care, I cannot speak to, but it must be very long. I *can* speak to ten years' constant wear; at the end of which, with a little repairing, and fresh oiling, they have been, for aught I know, as good as ever. See how readily a fold is shifted! The nets are made in 30-yards lengths: each length, as taken up, is wound on a fold-stake, and carried with the greatest ease on the back either of the shepherd or his page; for it is proper to note that the wire, having been well annealed, is exceedingly pliable, and by so much the more durable.

There is another species of netting for gardens, to which I have lately been turning my attention, the meshes of which are 9 in. square, and of thicker wire still: I use it wherever I want an invisible fence against dogs, to prevent them running over flower borders, for instance. But there is another purpose to which I am about to apply it, and where, it strikes me, I shall find it very useful—in the training of espalier fruit trees. Of course, my stakes must be tolerably stout, and perhaps thickly set: this time will determine. I will give you the results, you need not fear, most faithfully and impartially. What do you think of some such contrivance in lieu of sticks for peas? I like peas well enough, but the litter and mess they make I do abominate; not to mention the unsightliness of their appearance whilst growing. Besides, where I live, pea-sticks are by no means easy to meet with. I think I shall try a row or two with the large net.

*Stoke Ferry, Norfolk, March 4. 1839.*

ART. V. *Pines found in the Taurian Caucasus.* By C. STEVENS.

[Translated from the "Bulletin de la Société Impériale des Naturalistes de Moscou." An 1838.]

IN the *Flora Taurico-Caucasica* are enumerated four species of *Pinus*, viz. *Pinus sylvestris*, *P. Laricio* (which the author at first considered to be *P. halepensis*), *P. Picea*, and *P. orientalis*. The researches of Sovitz, Nordmann, and Wittmann have since made us acquainted with many other forms; but amongst these I can discover only two species, the remainder appearing to me to be varieties.

The genus *Pinus* should, I think, be retained entire, as originally proposed by Linnæus: for the characters by which Tournefort, and many others after him, and lately Link, distinguish *Pinus*, *Abies*, *Picea*, and *Larix*, although very convenient for the separation of cognate species, are totally insufficient for the constitution of genera. The strobile of the *Abies* Link [*Picea Arb. Brit.*], in which the scales are deciduous, closely resembles that of the *Picea* [*Abies Arb. Brit.*], in which they are persistent; nor do those of *Larix* differ from this last, though *Larix* rather resembles *Pinus* in its grouped leaves. Their generic affinity is further demonstrated by the grafting of *P. Cedrus*, which Pott (*Du Roi, Baumzucht*, 2. 124.) found to succeed on *Abies* and *Picea*, and which I have myself seen successful in the Nikita Garden on *P. taurica mihi*. True distinctions are to be sought in the nuts themselves; but these, although they vary in different species, do not afford generic characters. For the division of the genus, the best characters are those proposed by Link.

I. *ABIES* Link. [*Picea Arb. Brit.*] Leaves flat, solitary.

1. *Pinus Picea* L. Leaves solitary, in double series, two-rowed. Strobiles erect, subcylindrical; scales orbiculately obovate; bractæas nearly as long as the scales, acute.

The author of the *Flora Taurico-Caucasica* merely states that it is found in the upper forests of the Caucasus, without indicating a specific locality. Sovitz sent me branchlets from the summit of Adshar, above Guriel; where, also, Nordmann saw it. Tournefort observed it, long ago, above Trapezas. My branchlets, which were without flowers or fruit, very much resemble those of *Pinus Picea* of Europe, except that they are smooth, whilst the latter are uniformly pubescent: whence I suspect that it is a distinct species, and should be called *P. leioclada*, although Tournefort expressly says that it differs in no respect from that of the Alps and Pyrenees.

As my European specimens want the strobiles, I have adopted the character of Link, in the *Linnæa Liter.*, Ber. 1833, p. 36.

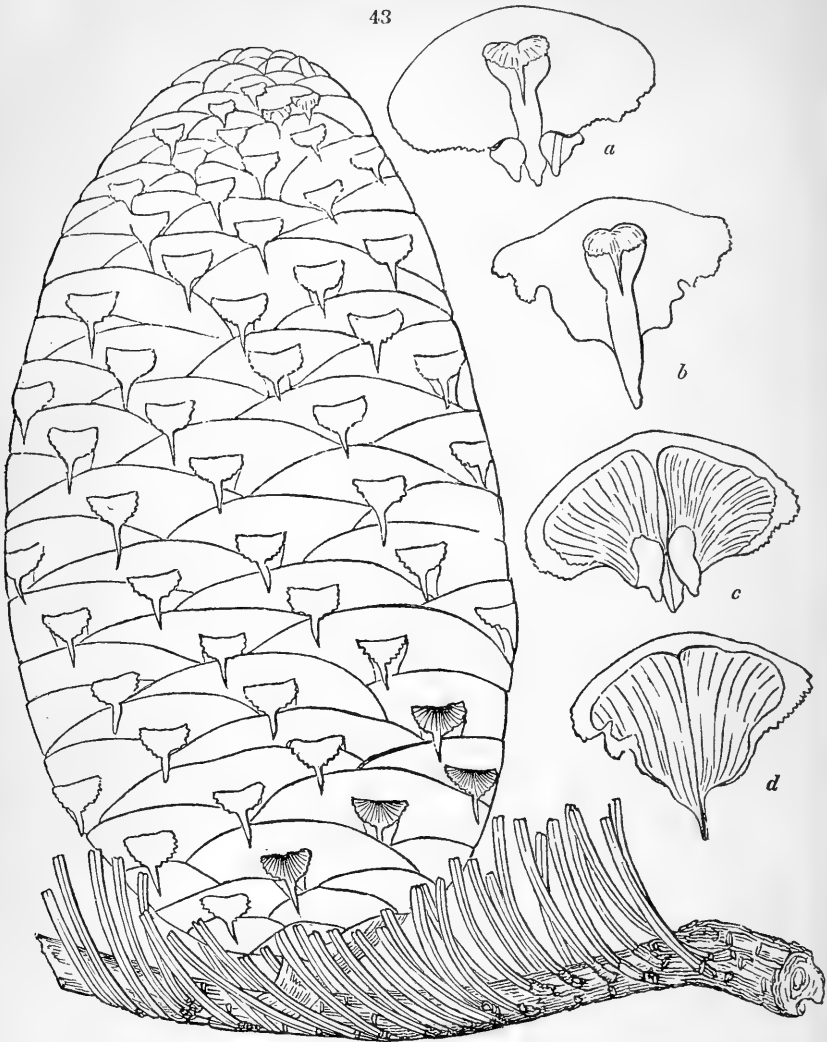
It is really wonderful how much authors differ in their descriptions of the scales and bracts of strobiles. Tournefort (*Inst.*, t. 353.) states that the bract equals the scale in length, and has a rather obtuse recurved point. Du Roi (*Harbk. wilde Baumz.*, 2. 135.) says that a slender point descends from the middle of a dark-coloured, dry, toothed tubercle (Erhabenheit). This point Reichenbach (*Flor. Germ. excurs. n.* 963.) and Richard, jun., (*Dict. Class. Sc. Nat.*, t. 5. p. 153.) ascribe to the scale itself. De Candolle, citing Gærtner, affirms the bracts to be altogether absent, hastily confounding it with *P. Abies L.* Link (*Linnaea*, l. c.) states that the bract equals the scale in length; while Ledebour (*Fl. Alt.*, 4. 202.) says that it is longer, but is silent as to its form, though he accurately describes that of the other species. On account of this obscurity, the diagnosis of the following species may not be correct as to the bractea. I may further add, that the figure in Lamarck's *Encycl. Ill. Gen.*, t. 785. g, is the cone of *P. Abies L.*, and not of *P. Picea*, for which it has been cited by Poiret (*Encyc. v. Sapin*).

The name of *Abies excelsa* has been infelicitously given to this species by Link; Lamarck, Richard, and De Candolle having previously adopted it for the *Pinus Abies L.*, *P. vulgaris Link.* It would have been far better to retain the name of *Abies Picea* now given by others to this of ours, than to open a door to new errors and intricate synonymy.

2. *Pinus Nordmanniana mihi.* Leaves solitary, curved upwards, of unequal length. Strobiles erect, ovate; scales very obtuse; bracts cuneate, with the apex reflexed, obcordate, long-mucronate, incumbent on the lower scale. (*fig.* 43.)

Discovered by Nordmann, on the summit of Adshar, above Guriel, towards the sources of the Kur, on the banks of the Nataneb, at the height of 6000 ft. Wittmann, now gardener at Odessa, observed it on the southern declivity of the mountains between Cartalin and Achalzich, about Azchur, as far up as the alpine region, growing amongst *Abies orientalis*. He has transmitted specimens to me, with the following remarks: — "This is a still finer tree than the preceding (*P. argentea*, infra). Its trunk is exceedingly straight, and above 80 ft. high; it is 3 ft. in diameter, with the smooth bark of *P. álba*. The branches are dense, about 2 in. scarcely ever 3 in. thick, and regularly disposed; the lower horizontal, the upper springing at a more acute angle. At from 14 to 17 years old it begins to bear fruit at top. When full-grown, the whole crown is covered, from a fourth part of its height, with large, conical, erect strobiles, solitary, or in twos or threes, and covered with a resinous exudation. The seeds ripen about the end of September, when they immediately fall off with the scales, the axis often remaining for the whole

43



year. The wood is harder than that of *P. orientalis*, and is not so much corroded by larvæ.”

A truly beautiful tree, from its very silvery leaves, and its abundant strobiles. The branchlets resemble those of *P. balsamea*, and are covered with rough dark-coloured down. The leaves are linear,  $\frac{3}{4}$  lin. broad, and about 1 in. long, with the point slightly emarginate; above, pale yellowish green, channelled; below, with a silvery glaucous line on each side of the midrib, equal in breadth to the keel and thickened margins.



They are in two rows, as in *P. Picea*, but longer; are more or less twisted at the base; have their points incurved; and are nearly equal. The male catkins I have not seen. The female strobiles are sessile, or on very short peduncles, erect, 5 in. long, and  $2\frac{1}{2}$  in. in diameter. Rachis 2 or 3 lines thick, gradually attenuated, ligneous, rough with tubercles spirally disposed for the insertion of the scales. There are 12—13 of these spiral lines, each containing 8 tubercles in its circumvolution, making a total of about 100 florets or 200 seeds in each strobile. Scales closely adpressed: superior (*fig. 43. a, c*) cup-shaped, narrow at the base for about 2 lines in length, then suddenly dilated into a lamina, at first straight and of 3 lines broad, afterwards greatly expanded, somewhat recurved, and nearly  $1\frac{1}{2}$  in. in breadth, which is also the length of the scale itself; inferior (*fig. 43. b, d*) much shorter, lamina with a subreniform base, triangularly crenate. Lateral margins of the lamina eroded, dentate, upper entire; inner surface slightly keeled, outer smooth. Bract adnate to the narrow base of the scale, then free, about a line broad at the middle, spreading by degrees into a lamina, rarely ovate, often cordate, reflexed at the apex, and incumbent on the lower scale; mucro  $1\frac{1}{2}$  line long; lamina equal to the scale in length. Nuts two, triangular ovate,  $1\frac{1}{2}$  line long, above a little broader, smooth; wing obliquely expanded by degrees to  $\frac{3}{4}$  in. in length and breadth, membranous; inner margin straight, and close to the other wing (*fig. 43. c*).

This species is sufficiently distinguished from *P. balsamea* and *Abies sibirica* (*Ledeb. Fl. alt.*, 4. 202.), by the size of the strobile, and long reflexed point of the bractea; and it differs still more from *P. Picea L.* in the shape of the bract and its upward-curved leaves. I have named it in honour of M. Nordmann, professor at Odessa, who made a dangerous journey into Colchis, in 1836.

II. *PICEA Link.* [*Abies Arb. Brit.*] Leaves solitary, subquadrangular.

3. *P. orientalis L.* Leaves solitary, subquadrangular. Strobiles cylindrical; scales broader than long, rhomboid-ovate, rounded at the apex, subentire.

I found this species in 1805, on the loftiest mountains of Imetia. Nordmann saw it frequently in Upper Mingrelia, especially in the neighbourhood of churches, and forming whole forests between Guriel and the Adshar Mountains.

A lofty tree. Leaves half as long as those of *P. Abies*, and like them quadrangular, acute but not pungent; neither are they 2-rowed, as Tournefort states, but cover the branches on all sides, as in *Abies*. Strobiles 3 in. long, subcylindrical; scales

more laxly imbricated as the seeds ripen, inferior broadly rounded, superior somewhat acute, with a few minute denticulations, sometimes without any.

Neither *Pinus Abies* L., nor *Picea vulgaris* Link, has been found in the Caucasus; nor has any species of *Larix* yet been discovered.

III. *PIÑUS* Link. [*Pinus Arb. Brit.*] Leaves in twos, threes, or fives. Scales thickened at the tip.

4. *P. marítima* Lamb. (not Link). [*P. halepensis Arb. Brit.*] Leaves in pairs. Strobiles conic, on short footstalks; scales at the lower part obtuse, towards the top mucronate, depressed at the back, and without a longitudinal keel.

On the shores of Abshasia, around Pezundan, the ancient Pityus; from which circumstance, formerly, when I thought it a distinct species, I named it *P. pityusa*. [See p. 130.] I received branches with strobiles, many years ago, from Admiral Greig, then commanding the Russian fleet in the Euxine; and subsequently from Surgeon Iljin.

This species is easily distinguished from the others, by its scales not being tuberculated on the back, but having an impressed pit in the middle. I refer it to *P. marítima* (*P. halepensis* Dec. Bertol.), although in some particulars they seem to differ. Leaves sometimes occur shorter and thinner than I have ever met with in *P. marítima*, scarcely 2 in. long; whilst other branches bear leaves so like those of *P. monspeliensis Salzmann* (which is a variety of *P. marítima*), that you would scarcely believe them the produce of one tree. It also agrees with the French tree in size of cone, and general form of scales; but in our specimen the upper scales are acute, and even mucronate, which I have never seen in *P. marítima*, nor has it been observed by any author, to my knowledge. The lowest scales have an apical orbiculate disk, with a round depression in the middle; the next have a trapezoidal apex, but still obtuse, and a medial transverse keel, twice or thrice the length of the disk, in a transverse oval pit; presently the apex becomes smaller and mucronate, often pungent; the keel also is conspicuous in the pit; and at last scarcely broader than long, with a smaller point, and a slightly elevated, transverse keel on each side of the pit.

I dare not cite any from Link (*Linnæa, Litt. Ber.*, 1833, p. 33. &c.): 9. *P. halepensis* agrees in other respects, but differs very much in the tuberculated back of the scale; 10. *P. marítima* differs in the transverse keel of the scale being obliterated, whilst in ours it is very conspicuous; the rest are still more dissimilar. From a specimen, but without fruit, given me by Billardièrre, I doubt the identity of the Syrian tree with the French

one, and therefore think the name of *P. marítima* should be preserved to the present species.

5. *P. Larício*. Leaves in pairs, rigid, and longer than the subduplex strobile. Strobiles conical, sessile; scales with an obtuse longitudinal keel, and a transverse acute one in the middle of the umbilicus, terminating in a mucro.

This species constitutes forests on the western summit of Tauria, sometimes descending even to the shore, but never passing over to the northern declivity. I have also received it from Gelintschik, a port on the eastern shore of the Black Sea, 100 leagues from the mouths of the Hypanis. The branches from Iberia, recorded in the *Flora Taurico-Caucasica*, 3. 627., I believe to belong to *P. sylvéstris*.

Marschall von Bieberstein has rightly distinguished this from the preceding, considering it to be *P. Larício*; nor do I think it any other, from comparing specimens from Corsica and the Paris Garden. Link (*Linnaea*, l. c.) says that *P. Pallasiana*, which is the *P. táurica* Lamb., differs but little from his *P. Pináster*; but this, in my opinion, is the same with *P. Larício*. But I do not think *P. nígra* Link (*P. Pináster* Schult., *P. austriaca* Tratt.) another species; for the slightest differences in the shield of the scales, and the wings of the seed, in a genus so variable, are not sufficient to separate species.

In ours the wing of the seed is nearly an inch long, below the middle a third of an inch broad; the apex is sharpish, and nearly equally marked with ferruginous dew, and not, as in *P. sylvéstris*, quite transparent between the brown bundles of nerves.

6. *P. sylvéstris*. Leaves in pairs, nearly as long as the ovate-conic short-peduncled strobile. Scales with a prominent dorsal tubercle, often hooked backwards.

Rare on both declivities of the Taurian Mountains, occupying only the highest regions; in Imeretia and the peak of Adshar, towards the sources of the Kur, sufficiently frequent; in Central Caucasus it here and there forms forests, while it is altogether wanting towards the east.

It occurs in Tauria with slenderer and thicker leaves, with subrotund very short-peduncled strobiles, and others long-conic and with sharpish scales, the middle ones with a scarcely prominent tubercle, the lowest a little, but still evidently, recurved. This is nearly Ledebour's description of *P. sylvéstris sibirica* (*Fl. Alt.*, 4. 199.). I have a specimen from Iberia, with the peduncle a very little longer, and all the scales with a little straight tubercle. Branchlets from the sub-alpine regions on the Terek, between Casbek and Kobi, bear broader leaves, with a more rigid and pungent apex, a shorter-peduncled strobile,

and scales with larger tubercles, the lower with very prominent recurved, obtuse mammillæ, exactly like *P. uncinata gallica*. Wittmann brought one perfectly similar from Lasistan. I consider all these to be the same species, although described by authors under various names; for the structure of the scales often varies on the same tree, nor do the male flowers afford any distinction. To this species I even refer the following, though much more different.

Var. *hamata* mihi. Leaves in twos, shorter than the elongated conic strobile. Scales with an elongated, acute, dorsal mucro.

Brought by Wittmann from Lasistan. Nordmann saw it in the subalpine regions of Mount Adshar.

Cones sometimes 3 in. long, acute at top. The dorsal tubercle of the scales often measures 2 lines, the mucro projecting far beneath the subjacent scale. Wing of seed narrow, equalling at its greatest breadth only a third of its length. However important these characters may seem to others, I cannot establish a species from them; for I have before my eyes cones of *P. sylvestris genevensis* and *austriaca*, shorter indeed, but in the hook of the scales scarcely yielding to *caucasica*; and others from seeds of *P. sylvestris europæa*, reared in the Nikita Garden, in like manner acutely conical, and armed with a long hook more or less recurved. Even among the specimens sent me by Wittmann occur cones much shorter, and with obtuser tubercles. All which maturely considered, I cannot separate the present tree from *P. sylvestris*.

Var. *argentea* mihi. Leaves in pairs, silvery-white, nearly as long as the ovate conical strobiles. Scales with a tubercle hooked backwards.

Seen by Wittmann in Lasistan, who remarks that he observed but one tree of it, and that not far from the village of Artamin, two days' journey from Batum. Lofty, densely branched, and full of leaves of a splendid silvery hue, it received its greatest beauty from its equally silvery cones. Nordmann also saw this variety on the summit of Adshar.

The branchlets loaded with cones which I received from Wittmann, except in colour, which, even in the dry state, is excessively white, agree in every point with *P. hamata*. The strobiles are a very little shorter, and the scales a little more shortly pyramidal, exactly as in the specimen of *P. hamata* above mentioned. One character only of greater moment is found in the wing of the seed, which is shorter (8 lines long) and broader (3 lines broad), giving it a sufficiently different shape. It is also more sparingly and unequally speckled with ferruginous dew, and the coloured nerves are scarcely conspicuous. But the form and

colour of the wing are not so constant even in the common *P. sylvéstris*: I am therefore forced to consider the present a variety only, and undoubtedly the most remarkable of them all.

ART. VI. *Notice of the Effects of the Winter of 1837-8 on certain Trees, Shrubs, and Plants, hardy and half-hardy, cultivated in the Handsworth Nursery, near Birmingham.* By ALEXANDER POPE.

RANUNCULA'CEÆ.

*Pædônia Moutan*, not at all injured, loamy soil, southern exposure, without protection.  
*Clématis cirrhôsa*, not at all injured, against a south wall, in stiff soil, with a wet bottom.

MAGNOLIA'CEÆ.

*Magnôlia grandiflora*, as a standard in peat soil; killed partially, but now recovering.

MENISPERMA'CEÆ.

*Schizândra coccinea*, killed.

BERBERI'DEÆ.

*Berberis dealbata*, in a light soil, killed.

*Chíttria*, or *aristata*, stiff soil, partially injured.

*rèpens*, light soil, slightly injured.

*glumàcea*, ditto, not at all injured.

*empetrifolia*, ditto, ditto.

*dúlcis*, ditto, ditto.

*actinacantha*, killed to the ground, but growing again.

*nepalense*, dead.

2 species from Kamoon, partially injured.

CISTI'NEÆ.

*Cístus*, all killed, except *C. formosa* against the front wall of a stove, which has grown again from the bottom.

PITTOSPO'REÆ.

*Pittósporum Tobira*, 4 ft. high, in a southern exposure, in a dark loamy soil, killed.

CAMELLIA'CEÆ.

*Caméllia japónica rubra plèna* stood in a stiff soil, in a southern exposure, as a common shrub,

for three or four years, and not in the least injured.

*C. j. flore simplici*, against a north wall, without injury.

*Thèa viridis*, all but killed, in a very sheltered situation.

HYPERICI'NEÆ.

*Hypéricum Kalmianum*, killed at top, only lower branches survived.

GERANIA'CEÆ.

*Eròdium hymenodes*, dead.

CELASTRI'NEÆ.

*Ilex* sp. Magellan, killed to the ground, now growing again.

RHA'MNEÆ.

*Ceanòthus collinus*, without the least protection, in a stiff soil, not at all injured; thus proving itself to be a most valuable hardy evergreen.

*Pomadéris pruniifolia*, in a light soil, well sheltered; killed down, but has sprung up again last summer.

This plant was first raised in the Handsworth Nursery, from seeds sent home by the unfortunate Douglas, and presented to J. Pope and Sons by the Hort. Soc. of London. Plants will shortly be ready for sale. (See *Arb. Brit.*, vol. iv. p. 2547.), also *Floral Cabinet and Botanist*.

*Collètia spinosa*, very much exposed, only partially injured.

*Alatérnus*, partially killed.

TEREBINTHA'CEÆ.

*Cneòrum tricóccum*, dead, having withstood 3 or 4 winters in a light soil, and southern exposure.

LEGUMINO'SÆ.

*Acàcia affinis*, having withstood se-

veral winters, plants 8 ft. high in a light peaty soil, exposed only to the south, completely killed.

*Edwárdsia microphýlla*, 4 ft. high, eastern exposure, dead.

*Genísta Scórpíus*, very severely injured (but recovering), in a light soil, sheltered.

*tríquetra*, large old plant killed, young ones escaped.

*Spártium radiátum*, not at all injured, in a damp situation, and exposed in stiff soil.

*Ulex europæa* a flore plèno, plunged in pots, nearly all killed; small plants in the ground not injured; large plants, 12 ft. in diameter, quite killed.

#### ROSA'CEÆ.

*Cratægus glábra*, 6 ft. high, in peat soil, exposed to the east, killed to the ground.

*Eriobótrya japónica*, 7 ft. high, ditto, ditto, dead.

*Cotoneáster microphýlla* and *Uva úrsi*, not in the least injured, though in very exposed situations.

Common Laurels in wet clayey grounds, some quite killed, others partially injured; some, in dry land, not at all injured.

Portugal Laurels, partially injured where exposed to the wind and sun.

*Dryas integrifolia*? *intermèdia*, fine plants, quite dead.

*Drummóndi*, on a rockery exposed to the west, a fine plant, not at all injured.

Roses. *Grevílea* and *bracteàta* killed. Some of the hybrid China killed as standards; dwarfs only partially injured. (I do not think the roses suffered anything like so much with us as they did in the south.)

#### PHILADE'LPHÆÆ.

*Deutzia scàbra* proved quite hardy.

#### MYRTA'CEÆ.

*Leptospérmum trinérvm*, in a clayey soil, exposed; having, during the last three or four years formed a handsome shrub 3 ft. high, being covered all over

every year with its delicate white flowers; killed down, nearly to the ground, but is now recovering.

*L. grandiflorum*, in a light peaty soil, well sheltered, was also killed down, but is growing again.

#### GROSSULARIÆ.

*Ribes speciòsum*, 7 ft. high, in a stiff loamy soil, exposed to the south, killed nearly to the ground, but has grown again vigorously.

*punctatum*?, same situation, killed down, but growing again.

*glutinòsum* and *malvæceum*, not at all injured.

#### ESCALLONIÆ.

*Escallònia floribúnda*, light soil, well sheltered, killed to the ground, but growing again.

*rùbra*, against a south wall, only partially injured; gravelly soil.

#### UMBELLÍFERÆ.

*Bupleùrum fruticòsum*, in an exposed situation, was quite killed.

#### CAPRIFOLIA'CEÆ.

*Víbúrnium Tinus*, *Laurustinus*, killed to the ground. The large dark-leaved variety appears to be much harder than the other kinds.

*Benthàmia fragífera*, killed.

#### LORA'NTHEÆ.

*Aúcuba japónica* stood much better than the common laurels.

#### VACCINIÆ.

*Vaccínium Arctostáphylos*, 7 ft. high, in peat soil, sheltered; all the foliage destroyed, but not otherwise injured.

#### ERÍ'CEÆ.

*Erica mediterrànea*, killed.

var. *Irish*, ditto.

*austràlis*, ditto.

*Menzièsia Dabœ'cia*, all the varieties, large plants killed, small ones partially so.

*Arbutus Andràchne*, in a southern exposure, not at all injured, in a stiff loamy soil.

*U'nedo*, 12 ft. high, very slightly injured, exposed to the south, in a stiff soil; small plant very severely injured.

*Pernéttya mucronàta*, in peat soil, in a sheltered situation; not a leaf injured.

*pilòsa*, having withstood several winters, a fine bush, flowering and bearing fruit in abundance, quite destroyed.

*Andrómeda arbòrea*, 12 ft. high, in a peat soil, sheltered with laurel hedges all round, was not in the least injured.

*Rhododéndron arbòreum álbum*, 6 ft. high, loamy soil, exposed to the south, main stem killed, layers survived, being sheltered from the wind.

*venústum, álta-clerénse, concínnum, Nobleànnum, &c.*, not at all injured, in a sheltered situation.

*Smithii*, near a pond exposed, only partially injured.

*campanulàtum* proved quite hardy.

*Azàlea índica (ledifòlia) álba*, on a rockery in a northern exposure, not injured.

OLE'INÆ.

*Phillýrea*, partially killed.

*Ligústrum lúcídum*, killed to the ground, but growing again.

BORAGI'NEÆ.

*Tournefòrtia heliotropiòides* was killed, after having withstood the two former winters.

SOLA'NEÆ.

*Solànum etuberòsum* proved quite hardy in an exposed situation, and in a clayey soil.

LABIA'TÆ.

*Sálvia Gràhami*, killed to the ground, but growing again in a light soil, sheltered situation.

*Phlòmis fruticòsa*, killed.

VERBENA'CEÆ.

*Verbèna rugòsa*, not at all injured.

LAU'RINÆ.

Sweet Bay, killed to the ground in all situations with us.

PROTEA'CEÆ.

*Bánksia austràlis*, having stood the two preceding winters well, killed.

*Hàkea pugionifòrmis?* 4 ft., having stood well three or four winters and flowered, killed to the ground, but recovering.

AMENTA'CEÆ.

Lucombe Oak, killed nearly to the ground, exposed to the east, in a damp situation.

Evergreen Oak, all the larger plants killed; some two years old, in the seedling bed, not injured.

CONI'FERÆ.

*Cunninghàmia lanceolàta*, in clayey soil, in a very exposed situation, has stood well.

IRI'DEÆ.

*Gladiolus cardinàlis* stood well, without protection, in a southern exposure.

AMARYLLI'DEÆ.

*Alstræmèria àirea* and *psittacina* stood well in the open border.

*Zephyránthes càndida*, in a southern exposure, not at all injured.

HEMEROCALLI'DEÆ.

*Trítoma mèdia* was killed, exposed situation.

*Burchéllii*, ditto, in a frame.

TULIPA'CEÆ.

*Phórmium tènax*, killed.

---

ART. VII. *On the Influence of the Winter of 1837-8 on certain half-hardy Shrubs in the Glazenwood Nursery.* By SAMUEL CURTIS, F.H.S.

You ask me how the frost of last winter has served my experimental plants in my Australian garden. My answer is very short, — *Sadly!* It was a sickener for experimental gardeners; and I have never known a more mischievous winter. When I even say this, I find I am more favoured than the nurseries and

other grounds in the neighbourhood of London; for, whilst I have only to complain of losing such plants as *Araucària brasiliensis*, 9 ft. high, established several years, and many doubtful kinds of *Eucalypti*, *Metrosidèros*, *Leptospermum*, *Bæckia*, &c., still I did not suffer in many things which, in the neighbourhood of London, were either totally killed or cut down to the surface of the ground. With me, not only the *Arbutus* was uninjured, but the fruit is now (January 10. 1839) red on the trees; sweet bays, almost uninjured in their foliage; camellias, quite uninjured, as are the *Thèa viridis* and the *Arbutus Andràchne*. Of the latter, a large bush, 8 ft. high, in a very exposed place, suffered very little indeed. But I was more surprised at finding the hardiness of the *Azàlea ledifolia* and *A. phœnicea*, also of the pale purple kinds, all of which stood well; and the white one was covered with blossom, although unprotected, and was much finer than those I wintered in the green-house. I am delighted with these plants, and will cultivate them extensively. I did not happen to have the *Azàlea sinense* exposed; but, under a hard-frozen frame, it was uninjured. You seem, in your general summary (Vol. XIV. p. 545.), to speak of injury to the *Rhododéndron pónticum*. I cannot trace a leaf that has suffered of that, or of *R. máximum*, *R. catawbiense*, or *R. caucásicum*: but *R. arbòreum* suffered much; and the hybridised varieties have also suffered in their foliage and blossom buds, although they did not in their wood. I consider *R. arbòreum* a conservatory plant, quite as much so as the camellia, and it will seldom be seen to flower well in the open ground; for, if the leaves are not much injured, the flower-buds get killed. *Ligústrum lúcídum* was killed down to the ground, but has shot up vigorously again. The *Laurustinus* was scarcely injured. *Cunninghàmia lanceolata* was rendered rather rusty in its branches; but its head, 8 ft. high and unprotected, is uninjured. Amongst roses there was much mischief done, principally amongst the thes or odoratas, grevilleas, banksias, and some of the varieties of *Ròsa índica*. I never had *Ròsa Bánksiæ* killed before; but I had last winter one killed as thick in its stem as my arm, and 30 ft. high; but, perhaps, that was partly owing to its extended growth, as I have plants of both the white and yellow as thick in their stems, and more than 20 ft. high, very healthy. Amongst standard roses, I observe that a great many which were moved in the months of October and November survived; whilst those unmoved, of the same kinds, perished, from the fulness of their sap vessels, I suspect: but the death of the rose stocks to so great an extent I cannot account for. I lost some thousands, and I suspect many of the heads that died arose from this cause. My son, who saw the nurseries in Germany, told me there was a great loss of stocks and roses from the same cause there.



I have much more reason to complain of the spring frost than that of the winter. The frost of the 16th of May did me ten times more mischief than all the frost of the winter. From that one night's frost, I think, I lost what would have been six tons weight of filberts, and other fruit in proportion; and many plants, with young tender foliage, were in a mournful state when the next morning's sun had shone a few hours on them. I have not seen so much mischief from a *spring frost* since 1802.

When I have the pleasure of seeing you at this place, which I hope will be when my American plants are in blossom, I want to draw your attention to some of my notions of improvements in growing apple trees. My old favourite dwarf trees, in shape like gooseberry bushes, now give way to standards, with their buds spurred in, all up their stems; similar to the pears treated *en quenouille*, so as to form pillars of fruit; but I must point out to you these things in practice, for you to describe them to your readers. — *Glazenwood, January 10. 1839.*

---

ART. VIII. *Notice of a new hybrid Mahonia, or Evergreen Berberry.* By T. RIVERS, Jun., F.H.S., &c.

IN common with all plant cultivators, I have from the first felt much interest in that beautiful tribe, the mahonias, or evergreen berberries. Thinking the species distinct and well defined, I without hesitation concluded that seedlings would have the true characters of their parents, and that by such means they could be propagated speedily and extensively. Guess, then, my surprise to find, from three years' experience, that the seed of *Mahonia repens*, growing near *Mahonia fasciculàris*, has produced invariably plants, which, having lost all the characters of *M. repens*, and approach to those of *M. fasciculàris*, but with larger and more robust foliage, and vigorous upright growth; producing their flowers from the axils of the leaves, as in the latter species, and not in terminal corymbs, as the former is inclined to do.

I need scarcely tell you how great an acquisition this hybrid is to the mahonias. It is, in fact, a most robust and perfectly hardy variety of *M. fasciculàris* (the most beautiful species yet introduced); and it will, undoubtedly, form one of the finest evergreen shrubs in our collections, not even excepting *Mahonia Aquifolium*. As accidental impregnation has done so much, for no artificial aid was resorted to (further than that the plants which happened to be blooming at the same period had been planted near together), we may expect numerous evergreen varieties, if *M. repens* and its hybrids be crossed with some of the more rare species. We have thus reason to hope for some interesting additions to our flowering evergreen shrubs, and that very speedily. — *Sawbridgeworth Nursery, March 18. 1839.*

ART. IX. *Arboricultural Notices, collected from various Sources, intended as supplementary to, or corrective of, the Information contained in the "Arboretum et Fruticetum Britannicum."*

THE most remarkable circumstances which have occurred in the arboricultural world since our last article of this kind, in p. 118., are the publication of the *Pinetum Woburnense*, reviewed in a future page; the introduction of numerous plants of *Picea cephalónica* and *Picea Pimsàpo*; and the production of a new hybrid *Mahonia* in the Sawbridgeworth Nursery.

#### EUPHORBIA<sup>A</sup>CEÆ.

*Búxus sempervirens* L., Arb. Brit. p. 1333., Hort. Lig. pl. 91. — The highest box tree that we received any account of for the *Arboretum Britannicum* was 21 ft., and the largest hedge 40 yards long, 12 ft. wide at the base, and 15 ft. high. Having seen a notice of a higher hedge in the *Gardener's Gazette*, as existing at Hitchin, we wrote to the proprietor, W. Wilshere, Esq., M.P. That gentleman obligingly sent us the following answer: — "The box hedge in my garden, about which you wrote to me a few days ago, is 180 ft. in length, and consists of sixty trees; their height is 36 ft., and their average circumference, 2 ft. from the ground, is 39½ in. They must, of course, be very old; but I have no means of judging of their age. They grow close under a building, to which they are attached by iron rods for support. I have always heard it conjectured that they must have been planted merely as a border, and, when having grown to a considerable height from neglect, that they were afterwards encouraged in their growth by cultivation. I fear they have seen their best days, as they are getting very thin and ragged. — W. Wilshere. Albany Chambers, March 1. 1839."

#### ULMA<sup>A</sup>CEÆ.

The Elm thrives better in calcareous soil than in any other, always excepting a clayey loam, which is the soil of all others best suited for this tree. The elms which line the road from Paris to Meaux grow on a good loam, though the stratum is but thin, on a subsoil of chalk. They appear exceedingly fine trees, till the traveller has passed Meaux; when, in taking the road to Ferté-Milon, he finds himself in an avenue of larger and more beautifully grown trees, with leaves of a far deeper green. The reason is, the soil is here a clayey loam of some depth. The soil of Paris, from the constant additions which it receives from old buildings, has become so calcareous, that scarcely a tree will grow in it except the elm. Some years ago, the minister of public works proposed to introduce a variety of trees in the Boulevards, instead of the elms, which had been cut down, or otherwise destroyed, during the "three days" of July, 1830. He applied to the Horticultural Society, and was furnished with a list of foreign and indigenous species, which it was thought would succeed. M. Poiteau, however, is of opinion that, if these trees had been planted, few or none of them would have succeeded. (*Annales d'Hort. Soc. de Paris, &c.*, tom. xxi.)

#### CORYLA<sup>A</sup>CEÆ.

*Corylus Colúrna*, Arb. Brit. vol. iii. p. 2029. — The dimensions of the two large trees of *Corylus Colúrna*, which stand in the park before the house at Merkenstein, between Vienna and Baden, are exactly as follows: I. Diameter of the trunk, 3 ft. 4½ in.; of the head, 72 ft.: total height, 70½ ft. II. Diameter of the trunk, 3 ft. 5 in.; of the head, 63 ft. 9 in.: total height, 61 ft. — *Jacquin. Vienna, Sept., 1838.*

#### TAXA<sup>A</sup>CEÆ.

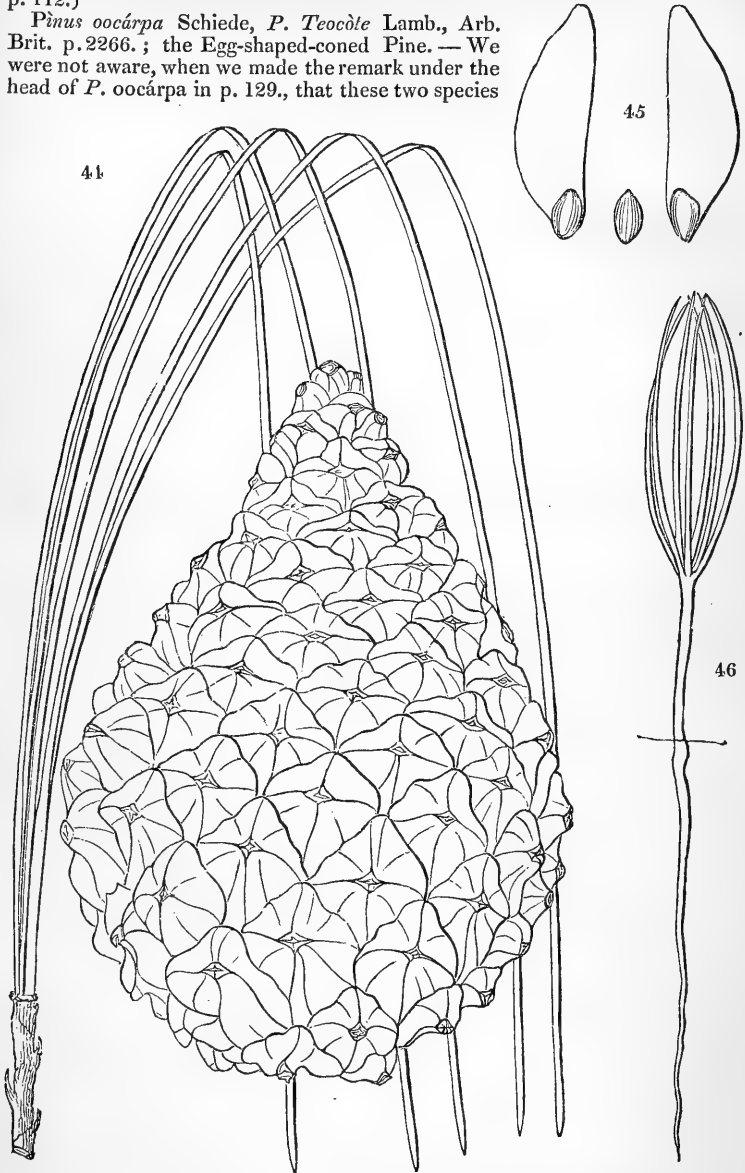
*Táxus Harringtônia*, a noble species of yew, figured and described in the *Pinetum Woburnense*, will be found noticed at length in a future page.

#### PINA<sup>A</sup>CEÆ.

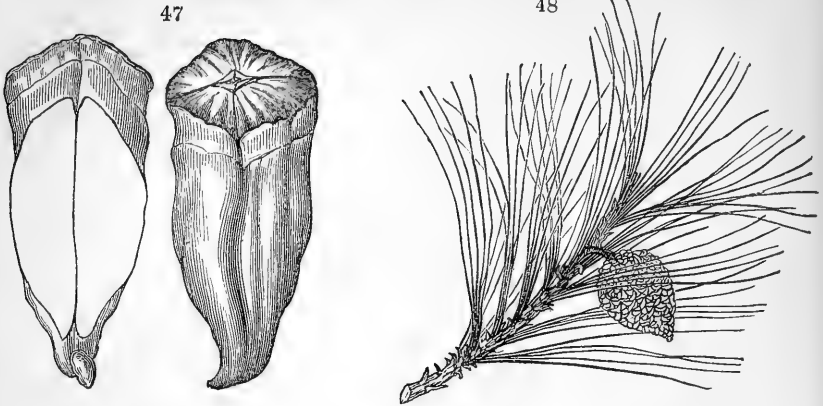
*Pinus austrális* Arb. Brit., *P. palménsis* Hort., may be grafted on *P. Larício*

by which it is rendered much hardier. (*Annales d'Hort. de Paris*, vol. xix. p. 112.)

*Pinus oocarpa* Schiede, *P. Teocôte* Lamb., *Arb. Brit.* p. 2266.; the Egg-shaped-coned Pine. — We were not aware, when we made the remark under the head of *P. oocarpa* in p. 129., that these two species



were considered to be the same. We now, according to promise, give an engraving (*fig. 44.*) of the cone and the leaves of the natural size. *Fig. 48.*



is a sprig to our usual scale of 1 in. to 4 ft. *Fig. 47.* shows the scales, *fig. 45.* the seeds, and *fig. 46.* one of the young plants just come through the soil; all these figures being of the natural size. A great many plants have been raised from the seeds distributed by the Horticultural Society.

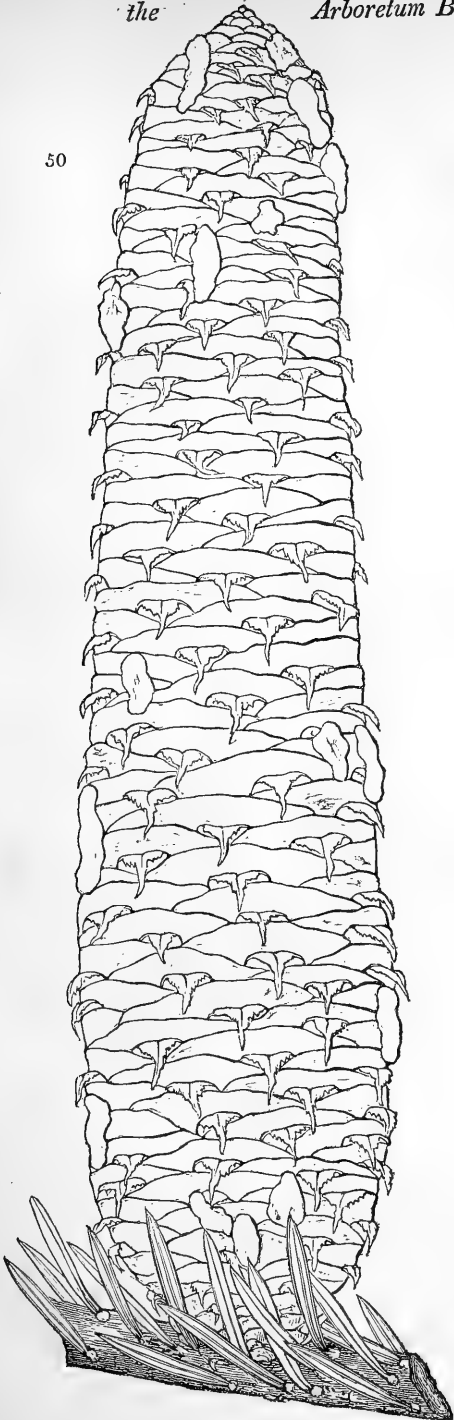
*Picea cephalonica*,  
*Abies cephalonica*, *Arb.*  
*Brit.*, p. 2326. — Since  
our last observations  
on this subject in p.  
126., H. L. Long, Esq.,  
of Hampton Lodge,  
near Farnham, to whom  
the seeds of the Cepha-  
lonian fir were first sent  
by Colonel, now Sir C.  
J. Napier, has received  
from a friend at Corfu  
a box enclosing branches  
of the fir, with cones  
and leaves attached, and  
containing abundance  
of perfect seeds. *Fig. 49.*  
is a portrait of one of  
the branches, kindly  
given us by Mr. Long,  
to our usual scale of 1  
in. to 4 ft. *Fig. 50.* is  
a cone of the natural  
size; *fig. 53. a, b, c,*  
scales and seeds of the  
natural size; *fig. 52.,*  
terminal buds of the  
natural size; and *fig.*  
*51.,* a seedling plant,  
just emerged from the  
soil, of the natural size.



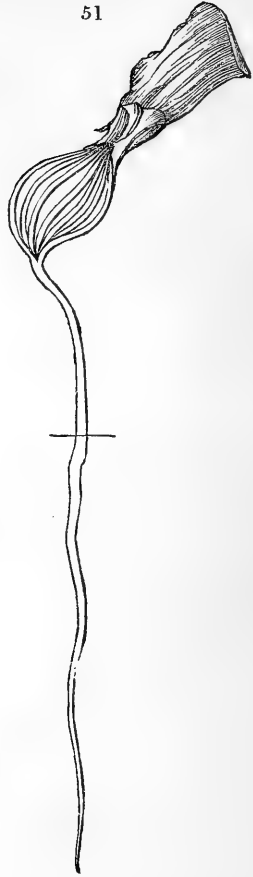
49

These figures place it beyond all doubt that the Cephalonian fir is a *Picea*; but whether only a variety of the silver fir, or a distinct species, may be doubtful. From the bristle-pointed leaves and their dilated petioles, we are strongly inclined to be of the latter opinion; but, should this fir not be a distinct species, it is, at all events, so marked and so beautiful a variety,

50

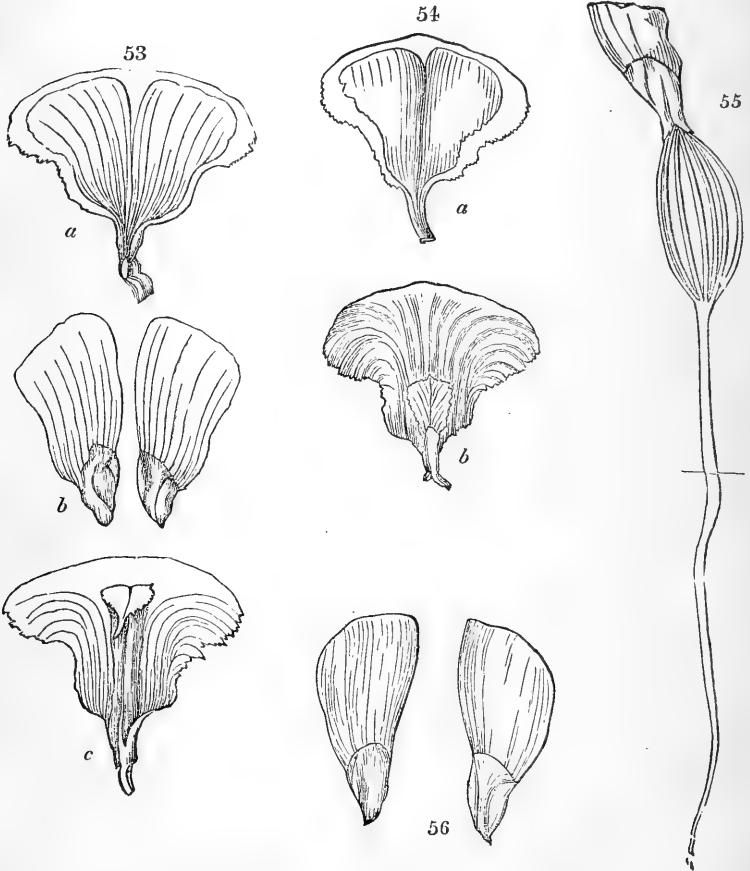


51



52

that no ornamental plantation ought to be without it. It appears to be quite as hardy as the silver fir. In Mr. Long's box there were a great many perfect seeds, which that gentleman has distributed in all directions, and, through us, to various botanic gardens both at home and abroad. A great many plants are come up from these seeds, as well as from those sold by Mr. Charlwood. It may be useful to observe, that seeds from these cones, which were so light as to float on water, and were apparently almost empty, have nevertheless vegetated and produced plants; and the same thing has occurred with the seeds of *Pinus oocarpa*.



*Pinus Pinsapo*. — Since what was stated by Mr. Lawson and M. Vilmorin, in p. 109. and 111., we have received seeds, scales, and a specimen of this tree. In the specimen the leaves were so very short, that to have produced an engraving from them would have been of little use; but *fig. 54. a b* shows the scales, *fig. 56.* the seeds, and *fig. 55.* a young plant just come up, all of the natural size. A great many plants of this species have been raised by Mr. Knight of the Exotic Nursery, King's Road. We are inclined to believe that this tree comes still nearer the silver fir than the *Pinus cephalonica*.

## CONIFERÆ CUPRESSINÆ, Arb. Brit. p. 2464., Hort. Lig. p. 125.

The following paragraphs are translated from the *Linnaea*, vol. xii., as promised in p. 130. The object is to make collectors acquainted with these different species, in order that, if possible, they may introduce them.

*Cupressus thurifera* H.B. & Kth.—We admit that the tree-like cypress in fruit, collected by Schiede, in the cold region, on the chain of mountains between Mexico and Cuernaavacao, below Encarnacion, and near St. Francisco cerea de Jenango, belongs to the species collected by Humboldt, near Tasco and Techuilotepec, at a height of only 920 toises, although some of them do not very well agree, and our friends have not mentioned that it is called cedar by the natives. I cannot find the following characteristic in the specimens before me: “Folia ovato-lanceolata acuminato-pungentia, vix lineam longa.” [Leaves ovate-lanceolate, acuminate-pointed, scarcely a line in length.] The leaves on the young shoots have, indeed, points, but they do not come gradually to a point, and stand upright. They are about one third of a line long, and lie closely pressed over each other in four rows, and it is only on the old twigs that they appear more pointed and larger; the cones that are burst open are smaller than sloes, and are about half an inch in diameter. A correct comparison of the specimens collected by Humboldt, or of those found in the same localities by others, with ours, would decide the point.

*Cupressus sabinoides* H.B. & Kth.—Not a decidedly fixed species, on account of the doubtfulness of the genus. See *Juniperus tetragona*, below.

*Juniperus mexicana* Schiede.—There is a short characteristic description of this species given in the *Linnaea*, vol. v. p. 77. Schiede found this species in the Llanos de Pirote, and Charles Ehrenberg near Mineral del Monte, at a height from 8000 ft. to 10,000 ft. It is a high pyramidal tree, from which a pale yellow resin frequently exudes, resembling sandarac, and which is found in drops or lumps on the branches, and is more frequently found on trees growing in low situations, than on those which are higher. This, as well as the following species, is called Sabina and also Cedro by the natives. The cone-berries (Zapfenbeeren) appear to be pretty large. We saw some half an inch in diameter. The scales do not sufficiently meet so as to cover the seed, so that one or two of the latter stand out quite free, from the point of the berry; or more rarely, stand out singly at the sides, separated by the substance of the berry. The specific name of mexicana is not very good, as we have already three species from that country, but it cannot be altered. The twigs and leaves of this species very much resemble the above-named cypress. The leaves do not always stand in threes on the twigs, but are often opposite; they are egg-shaped, and pointed; on the points of the youngest shoots only a half to three fourths of a line long, and have frequently two small longitudinal furrows on the back; the points are pressed to the shoot, and close together; the small shoots stiff and straight. The male catkins are only  $1\frac{1}{2}$  lines long, the scales almost kidney-shaped, with small convex closely pressed points, slightly bent inwards, and a cavity underneath in the middle of the scale.

*Juniperus flaccida*. New species. — A strong high tree with hanging shoots (Zweigen), with four-rowed, scaled, egg-shaped, little, lance-like leaves; the fruit globular, with projecting pointed scales. Schiede found this species at Atotonilco el Chico, in June, 1830, and Charles Ehrenberg at Regla, at a height of from 6000 ft. to 8000 ft. This tree produces a fine resin, but in a smaller quantity than the preceding species; and is easily distinguished by its thin pliable shoots, and very pointed upright little leaves, which are from three fourths to a line long. The male flowers (like those of *J. virginiana*) appear in small catkins on all the points of the small shoots; their scales also are pointed, but the points are not so much extended; yet neither they nor the leaves are bent inwardly, but stand upright, and rather somewhat outwardly inclined. The bursting of the seed from the cone-berry also takes place here, but almost quite in a regular manner, as the seeds make their ap-

pearance opposite each other, according to the situation of the scales. Other specimens have not this appearance. Is it therefore only accidental in some specimens, and does it not also take place with us in *J. communis*?

*Juniperus tetragona*. New species. — A shrub with low-growing, almost flat, branches; the leaves are in four rows, and lie close over each other, rather thick, obtuse egg-shaped; the fruit globular and small. It was found by C. Ehrenberg at Mineral del Monte, at a height of from 10,000 ft. to 11,000 ft. This species might be taken for *Cupressus sabinoides* *H. B. & Kth.*, although Kunth describes the plant as a tree. Humboldt found it in sunny rocky situations, at Cofre del Perote, near El Pinahuitepec, at a height of 1,500 toises. The youngest twigs are almost four-sided, rather stiff, straight, or slightly bent; the leaves are thick and short, and about from half to three fourths of a line long; they lie close over each other, are quite obtuse, and convex on the back, with the obtuse end pressed down. It is only the leaves of older twigs that are more pointed. This species does not produce resin. The globular berries are from 3 to 4 lines in diameter, but are not yet ripe. In Kunth's short description, the leaves are only from one fourth to one third of a line long, as they generally appear on the end shoots of our twigs.

ΤΑΧΑΨΕΛΕ, Arb. Brit. p. 2065., Hort. Lig. p. 117.

*Taxus globosa*. New species. — This species exceedingly resembles one of our European yews, but the fruit certainly is different. At first, I also thought there was a difference in the leaves, as they have small thin points, and the yews in our gardens have not; but when I compared this species with the alpine specimens, I found they had also similar points. The fruit, when young, has quite a different appearance from the European yew; it is more of a globular or depressed form, and the cup in which it lies has almost a cylindrical bell shape, while that of the European species has more of the barrel form; the scales, also, under the cup have quite a different appearance and consistency. The leaves are generally, perhaps, somewhat smaller, viz. from 9 to 10 lines long, and only three fourths of a line broad, and apparently somewhat more crooked. Charles Ehrenberg found this tree 20 ft. high, at Real del Monte, between El Canino del Paso and Huajalote. It bears fruit in September. (*Linnæa*, vol. xii. p. 496.)

---

ART. X. *Botanical, Floricultural, and Arboricultural Notices of the Kinds of Plants newly introduced into British Gardens and Plantations, or which have been originated in them; together with additional Information respecting Plants (whether old or new) already in Cultivation: the whole intended to serve as a perpetual Supplement to the "Encyclopædia of Plants," the "Hortus Britannicus," the "Hortus Lignosus," and the "Arboretum et Fruticetum Britannicum."*

*Curtis's Botanical Magazine*; in monthly numbers, each containing seven plates; 3s. 6d. coloured, 3s. plain. Edited by Sir William Jackson Hooker, LL.D., &c.

*Edwards's Botanical Register*; in monthly numbers, new series, each containing six plates; 3s. 6d. coloured, 3s. plain. Edited by Dr. Lindley, Professor of Botany in the London University.

*Maund's Botanic Garden, or Magazine of Hardy Flower Plants cultivated in Great Britain*; in monthly numbers, each containing four coloured figures in one page; large paper 1s. 6d., small 1s. Edited by B. Maund, Esq., F.L.S.



*Paxton's Magazine of Botany, and Register of Flowering Plants*; in monthly numbers; large 8vo; 2s. 6d. each.

*The Floral Cabinet*; in monthly numbers, 4to; 2s. 6d. each. Conducted by G. B. Knowles, Esq., M.R.C.S., F.L.S., &c., and Frederick Westcott, Esq., Honorary Secretaries of the Birmingham Botanical and Horticultural Society.

*The Botanist*; in monthly numbers, each containing four plates, with two pages of letterpress; 8vo; large paper, 2s. 6d.; small paper, 1s. 6d. Conducted by B. Maund, Esq., F.L.S., assisted by the Rev. J. S. Henslow, M.A., F.L.S., &c., Professor of Botany in the University of Cambridge.

*CRUCIFERÆ.*

1867. *ERYSIMUM*  
\**Perowskianum* Fisch. et Meyer Perowski's O or 1½ jn. O.S Palestine 1838. [cab. no. 96 S co Flor.

A hardy annual, with very large orange-scarlet flowers. It is a native of Palestine; and was sent to the Birmingham Botanic Garden, from the Botanic Garden at St. Petersburg, in 1838. (*Flor. Cab.*, April.)

*Silenaceæ* Lindl., *Caryophyllaceæ*, Dec.

1386. *DIA'NTHUS* 11394 ferrugineus *Bot. Reg.* 1839, t. 15.

*Hypericineæ.*

2190. *HYPERICUM* 19759 *hyssopifolium* *Flor. Cab.* No. 91.

*Oxalideæ.*

1414. *O'XALIS*  
\**Darwelliana* Know. et West. Dr. Darwell's ✱ Δ1 or ½ ... W.C ... .. O ... Fl. cab. no. 93

"This is a very delicate plant, but shy in producing flowers, and still more shy in expanding them." This species has a tuberous creeping root, and white flowers, bordered with crimson. It is named after the late Dr. Darwell of Birmingham. Neither the native country nor year of introduction is given; and nothing is said of the time of flowering or proper soil. (*Flor. Cab.*, March.)

*Leguminosæ.*

+ *Hovea crispa* Lindl. Received by R. Mangles, Esq., from the Swan River, in 1837. "It forms a bush 2 ft. high, with small purple flowers," which appear in February. (*B. M. R.*, No. 19. March.)

2075. *COLOGA'NIA*  
\**pulchella* H. et Kth. pretty 3 Δ1 or 3 s Ro Mexico 1837. C p.1 *Botanist*, no. 110

This elegant little climbing plant was raised by George Barker, Esq., of Birmingham, from Mexican seeds. It does not grow high, and flowers in autumn. It requires the protection of a green-house. (*Bot.*, March.)

10630. *MIRBELIA* 10630 *Baxteri*.  
*Synonyme*: *Oxylôbium scândens* *Bot.* No. 114.

*Cactaceæ.*

1473. *EPIPHY'LLUM*  
\**Russellianum* Hook. *The Duke of Bedford's* £ □ pr 3 my Pk Brazil 1839. C rocks and  
*Synonyme*: *Cereus Russellianus* Gard. MS.

This species is common on the mossy stems of trees, and also occasionally upon rocks, among the Organ Mountains. It is nearly related to *E. truncatum*, but grows at a much greater elevation. It was sent home by Mr. Gardner for His Grace the Duke of Bedford, and it is now added to the magnificent collection at Woburn Abbey; under this head, Sir W. J. Hooker mentions that a letter has been received from Mr. Parkinson, Consul General at Mexico, stating that other specimens of *Cereus senilis*, still larger than those before sent, have been despatched to His Grace; and two allied kinds, one downy, and the other spinous. Also a *Mammillaria* (yellow), supposed to weigh upwards of 2 cwt. It was borne on the shoulders of eight Indians for a considerable distance before it was placed on the waggon which conveyed it from the interior to Mr. Parkinson. This large plant is used in Mexico as a

sweetmeat, being cut into pieces like a gourd or citron, and preserved with sugar. It had flower buds upon it when packed up to send to Europe. (*Bot. Mag.*, April.)

"We can readily participate," says Sir W. J. Hooker, "in the pleasure Mr. Gardner must have experienced in discovering this beautiful epiphyllous plant, and dedicating it to his distinguished patron, the Duke of Bedford, a nobleman who, in the short time of Mr. Gardner's absence (scarcely three years) has amassed such a collection of cactoid plants at Woburn Abbey, as must be seen to be appreciated, and with which none in the kingdom, that I know of, can be compared, except it be that of James Harris, Esq., of Kingsbury, near Hendon. In the stoves at Woburn, the great columnar kinds of *Cereus*, 30 ft. high (and especially the noble specimens of *C. senilis*, two of which have attained to 12 ft., and are clothed with long, pendent, white hairs), contrast admirably with the strangely broad and depressed forms of the *Melocactus* and *Echinocactus* group, beset, too, as these are, with spines of every shape, and size, and colour: again, the latter kinds present a most curious difference of aspect from the flattened and jointed stems of the *Opuntia* and *Epiphylla*; while the magnitude and fragrance of the blossoms of some, and the brilliancy of colour in others, are surpassed by few vegetable productions. The arrangement and high health and vigour of the plants at Woburn reflect the utmost credit on the able gardener, Mr. Forbes."

*Rubiaceæ.*

- \* ANOTIS *Dec.* (From *a*, priv., and *ous otos*, an ear; no accessory teeth, or ears, to the calyx.) [no. 683  
\*ciliolosa *G. Don* ciliated-leaved  $\text{£} \Delta$  pr  $\frac{1}{2}$  jn.s Pa.Li N. Amer. 1832. D s.p Bot. gard.  
*Synonymes*: *Houstonia ciliolosa* *Torrey*; *Hedyotis ciliolosa* *Hook.*

The genus *Anotis*, which comprises the genera *Houstonia* *Lin.*, and *Hedyotis* *Ruiz et Pav.* and *Cav.*, was established by De Candolle in his *Prodromus*, vol. iv. p. 431. *Anotis ciliolosa* is a pretty little plant, which will flower from June to September, in the open border, or on rockwork, for which it is remarkably well adapted. (*Bot. Gard.*, March.)

*Compositæ.*

2411. RUDBE'CKIA 21978 *amplexifolia* *Jacq.*

*Synonyme*: *Dracopis amplexicaulis* *Cass.*, *Bot. Mag.* 3716.

Drummond's  $\text{£} \Delta$  or 2 au O.B. ? N. Amer. 1836. D [of bot. 6. p. 51  
co *Pact. mag.*

A very handsome species of a well known genus. (*Part. Mag. of Bot.*, April.)

*Campanulacæ.*

613. RO'LLA

\**elegans* *Part.* elegant  $\square$  or  $\frac{1}{2}$  my P ? C. G. H. 1836. C.S s.l *Mag. of bot.* 6. 27

This very elegant little plant, if kept in a hot-house, will flower during the whole of the winter months. It should be kept in a very small pot on a dry shelf, with which treatment it will flower and seed freely. (*Part. Mag. of Bot.*, March.)

*Epacridacæ.*

504. E'PACRIS

4283 *impressa* var. *parviflora* *Lindl.* small-flowered *Bot. Reg.* 1839, t. 19.

The flowers of this variety are of a deep red; and though small, they are so abundant as to produce a very pleasing effect. The plant was sent from New Holland, by Mr. James Backhouse, to his brothers at York, under the name of *E. ruscifolia*; but it differs from that species in not having stalked leaves. (*Bot. Reg.*, April.)

*Asclepiadacæ.*

776. HO'YA

*coriacea* *Blume* leathery ?  $\text{£} \square$  or ? 2 au W.Y Manilla 1838. C r.w *Bot. reg.* 1839, t. 18

A very pretty species, with leathery leaves, and white flowers tipped with yellow. It was sent by Mr. Cuming, from Manilla, to Messrs. Loddiges, with whom it flowered for the first time in August, 1838. It is grown "in the orchideous house, on the block of wood on which it was imported," which is

placed in a pot, and surrounded with light soil; and it is found to require a warm and moist atmosphere. "It does not send out roots from its stem like the other species, and is found at present rather difficult to propagate. However, there is little doubt of its being multiplied with a little patience, either by cuttings or layers." (*Bot. Reg.*, April.)

*Scrophulariææ.*

1787. **TORÉNIA**  
\*cordifolia *Roxb.* heart-leaved [ ] cu  $\frac{1}{2}$  o Pa. Li Samulcottah 1838. S r.1 Bot. mag. 3715

A little annual of no great beauty, which requires a stove in England. It is a native of moist pastures near Samulcottah in India; but, even there, it is not common. (*Bot. Mag.*, March.)

1718. **CHELO'NE** 15462 barbata *Cav.*  
*Synonyme*: *Pentstemon barbatus Lindl.*

1717. **PENTSTE'MON** barbatus var. carneum *Lindl.*, flesh-coloured bearded.

A native of Mexico, raised from seed presented to the Horticultural Society by G. F. Dickson, Esq. It is a hardy perennial, growing 2 or 3 feet high, and flowering in July and August; and it may be easily increased either by seeds or cuttings. "It may appear necessary," observes Dr. Lindley, "to offer some explanations of having changed the name of this plant from *Chelone* to *Pentstemon*. These two genera have been divided by the former having woolly anthers, and the latter smooth ones; and, supposing that this were really the essential distinction between them, the subject of this notice would belong to *Pentstemon*." Dr. Lindley continues, that, supposing the difference to lie in the corolla and seeds, still this plant belongs to *Pentstemon*. In short, he adds, that he agrees "with Mr. Bentham in striking out of the genus *Chelone* all the plants hitherto referred to it, with the exception of *C. Lyoni*, *glabra*, *obliqua*, and *nemorosa*." (*Bot. Reg.*, April.)

*Acanthæææ.*

1727. **RUE'LLIA**  
\*ciliatiflora *Hook.* fringe-flowered [ ] or 1  $\frac{1}{2}$  s Pa.P Buenos Ayres 1838. S co Bot. mag. [3718

A very handsome species of *Ruellia*, with pale purple flowers, sent to the Glasgow Botanic Garden, by Mr. Tweedie, from Buenos Ayres; though Sir W. J. Hooker suspects that it was brought there from some country in the interior. It flowered in the stove in September. (*Bot. Mag.*, April.)

*Begoniæææ.*

- [2654. **BEGO'NIA** 29529 parvifolia *Schott*, not Otto, *Bot. Mag.* 3720.

*Thymelæææ.*

87. **PIMELE'A**  
\*Hendersoni *Graham* Mr. Henderson's [ ] or 2 jl Pk King George's Sound 1837. C s.p [Bot. mag. 3721

A very ornamental species, which Dr. Graham thinks should be placed between *P. decussata* and *P. rosea*. It is a native of King George's Sound, whence seeds of it were sent to Messrs. Eagle and Henderson, Edinburgh, by Captain Cheyne, in May, 1837. It is a low shrub, with a profusion of beautiful pink blossoms, and promises to be a great acquisition to our green-houses. (*Bot. Mag.*, April.)

*Aristolochiæææ.*

2582. **ARISTOLO'CHIA**  
hyperborea *Hort.* northern [ ] or 20 my P.Lam ? India ? 1836. D 1 Part. mag. of [bot. 6. p. 53

A very showy and curious climbing species of *Aristolochia*, which flowered in 1838, in the stove of Mr. Knight, King's Road, Chelsea. It has also flowered at Messrs. Ronalds's, Brentford. (*Part. Mag. of Bot.*, April.)

*Orchidæææ.*

2540. **ONCIDIUM** 22688 luridum var. guttatum *Lindl.* speckled.  
*Synonyme*: *Epidendrum guttatum L.*; *Cymbidium guttatum Willd.*; *Oncidium Boydi Hort.*

"That this is the long lost *Epidendrum guttatum* of Linnæus," says Dr. Lindley, "I do not doubt." It was imported from Jamaica by Messrs. Rollisson, and only differs in its colour (which is yellow, spotted with red) from *O. lucidum*. Under this head, Dr. Lindley repeats the observations of

M. Descourtilz, which he before gave in the *Botanical Register*, 1838, t. 48., and we quoted Vol. XIV. p. 482., with the following additions: *O. ciliatum* flowers in September; *O. iridifolium* has the fruit large, and with six transparent wings, it flowers in April; *O. pubes* flowers in May; and *O. divaricatum* in February. (*Bot. Reg.*, March.)

*luridum* var. *Henchmani* Flor. Cab. No. 97. Henchman's.

A very pretty and striking variety of *O. luridum* in the collection of Messrs. Low, imported from Mexico in 1837.

*raniferum* Lindl. var. *majus* Hook. larger Bot. Mag. t. 3712.

This plant differs only from the species described by Dr. Lindley (*Botanical Register*, 1838, t. 48., and quoted in our Vol. XIV., p. 482.), in having somewhat larger flowers. It was imported from Brazil by Mr. Knight. (*Bot. Mag.*, March.)

*reflexum* Lindl. reflexed £ ☒ or ? 1 o Y Mexico 1836. D p.r.w Botanist, no. 116

Nearly allied to *O. altissimum*, and first described by Dr. Lindley in the *Botanical Register*, vol. x. t. 1920. new series, under *O. crispum*. (*Bot. Reg.*, April.)

2537. MAXILLA'RIA [1839, 17.  
*stapeloides* Link et Otto Stapelia-like £ ☒ cu  $\frac{1}{2}$  s G.P Brazil 1828. D p.r.w Bot. reg.

The singular speckled flowers of this species resemble those of a *Stapelia*, while "its pallid, glaucous, thin leaves, look as if suffering under the attack of the red spider. It is one of the most easy species to cultivate." (See their culture given under *M. tenuifolia*, as quoted p. 136. (*Bot. Reg.*, March.)

*vitellina* Lindl. yolk of egg-like £ ☒ or  $\frac{1}{2}$  jn Y.B Brazil 1838. D p.r.w Bot. reg. 1839, 12

This epiphyte has been already described in the *Botanical Register Miscellany*, for 1838, No. 116. (see our Vol. XIV. p. 481.) It is allied to *M. racemosa*. (*Bot. Reg.*, March.)

2553. CATTLE'YA 29657 *Perrinii* Lindl.

*Synonyme*: *Cattleya intermedia*, var. *angustifolia* Hook., Bot. Mag. t. 3711.

\*HUNTLE'YA Bate. (The Rev. — Huntley.) [1839, 14  
\**melægris* Lindl. checkered £ ☒ spl 1 jn Y.r.w W Brazil 1838. D p.r.w Bot. reg.

This very splendid flower, Dr. Lindley considers as "one of the rarest epiphytes in cultivation." The blossoms are large, and of a brilliant yellow, stained with scarlet, and marked with longitudinal lines, crossed with transverse ones, which give it a tessellated appearance. "The labellum is triangular, tongue-shaped; of a pure ivory white, bordered with deep purple, and nerved with a deeper tint." "This charming plant is found in gloomy damp woods on the banks of the Rio de Pirapitinga, in the district of Bananal [in Brazil]. It is scentless, and flowers in June." Dr. Lindley adds that Messrs. Rollison informed him that they had this plant and *Zygopetalum cochleare* from the same country; in which case he must have been mistaken in supposing that the latter plant came from Trinidad. (*Bot. Reg.*, March.)

*H. violacea* Lindl. "The flowers are a deep rich violet, darker than the darkest part of *Zygopetalum Mackaii*; they are between 2 in. and 3 in. in diameter, and are tipped with greenish yellow, melting downwards into white, which soon confounds itself with the general tint of rich violet." (*B. M. R.*, No. 17., March.)

+ *Cheiróstylis parvifolia* Lindl. This is an inconspicuous plant, but it is interesting, as being the first species seen in England of the genus *Cheiróstylis*, of which one only had been before described by Dr. Blume. It was imported by Messrs. Loddiges from Ceylon. (*B. M. R.*, No. 20., March.)

+ *Scaphyglóttis reflexa* Lindl. "Like the rest of the genus, it is a species quite destitute of beauty. It was obtained by Messrs. Loddiges from Demerara." (*B. M. R.*, No. 21., March.)

+ *Macradenia mutica* Lindl. A small plant with dingy white flowers, which flowered with Mr. Knight, of the King's Road, in August, 1835. It is said to be a native of Trinidad. (*B. M. R.*, No. 22., March.)

2524. CIRRHÆA 22642 viridi-purpurea var. Fryana Fl. Cab. No. 94.

Differing very little from the species. (*Fl. Cab.*, March.)

2542. CÆLOGYNE 29733 Wallichiana Mag. of Bot. 6. 25. (see p. 78.)

*C. ocellata* Lindl. "This beautiful plant has just flowered imperfectly with Messrs. Loddiges, who imported it from India." (*B. M. R.*, No. 35., April.)

*Sarcochilus olivaceus* Lindl. "A New Holland epiphyte of no beauty." "The flowers are small, and of a yellowish green." (*B. M. R.*, No. 27., April.)

*Cymbidium iridifolium* Cunn. On decayed trees in damp shady woods. The plant was alive at Kew. (*B. M. R.*, No. 37., April.)

*C.?* A vanda-looking plant, in habit very much like *V. teretifolia*. (*B. M. R.*, No. 31., April.)

2571. CALA'NTHE 22796 veratrifolia R. Br.

Found in Illawarra, near Port Jackson, by Mr. Allan Cunningham, in August, 1822. (*B. M. R.*, No. 39., April.)

2558. BLEPHIA 22752 Tankervillea.

Synonyme: *Phajus grandifolius Loureiro*.

This plant Mr. Cunningham discovered in September, 1824, growing in extensive swamps on the shores of Moreton Bay. (*B. M. R.*, No. 40., April.)

2526. BRASAVOLA

\*cuspidata Hook. spear-tipped  $\text{£} \square$  el  $\frac{1}{2}$  ... W Trinidad 1838. D p.r.w Bot. mag. 3722

A very elegant species of *Brasavola*, received from Trinidad with many others, by John Moss, Esq., of Otterspool, near Liverpool. It is nearly allied to *B. cucullata* Br. (*Epidendrum cucullatum Botanical Magazine*, t. 543.). (*Bot. Mag.*, April.)

2547. DENDROBIUM

aureum var. pallidum Lindl. pale golden-flowered  $\text{£} \square$  or 1 ja.mr Pa.Y.w Ceylon ? ..... [D trees Bot. reg. 1839, t. 20

A beautiful species, with pale yellow and white flowers. The fragrance is delightful, being "something intermediate between violets and primroses." (*Bot. Reg.*, April.)

crumenatum Swartz pouch-stemmed  $\text{£} \square$  el 1 au W Ceylon 1836. D trees Bot. reg. [1839, t. 22.  
Synonymes: *Angraecum crumenatum Rumphius*; *Onychium crumenatum Blume*.

*Rumphius* first figured and described this species without mentioning its habitat. *Dr. Blume* found it in Java, *Sir Stamford Raffles* in Sumatra, and *Mr. Nightingale*, who sent it to the Duke of Northumberland, in Ceylon. The flowers are white, varying, according to *Blume*, to pink, "with leaves more or less oblong and coriaceous. It is one of the easiest of the genus to manage, and well repays the cultivator the trouble he bestows on it." All it requires is, to be kept warm and moist during the growing season, and cool and dry during the season of rest. (*Bot. Reg.*, April.)

29819 formosum handsome  $\text{£} \square$  spl  $1\frac{1}{2}$  ap.my W.Y Khoseea 1837. D tree Paxt. mag of bot. vi. 49.

+ *D. linguæforme* Swartz. The flowers are of a greenish white, and of no beauty. The leaves are hard, thick, and tongue-shaped, having the texture of those of the aloe. The plant is a native of the country round Sydney, where it was discovered by some of the earliest botanists who visited New South Wales. (*B. M. R.*, No. 26., April.)

+ *D. teretifolium* R. Brown. A small creeping species, of no great beauty, "with deep green, fleshy, taper leaves, between 2 in. and 3 in. long, and solitary flowers of a dull yellow, streaked and spotted with dull purple; the labellum is white. It and all the following species are natives of New South Wales." (*B. M. R.*, No. 29., April.)

*D. tetragonum* Cunn. Found on "the stems of small trees, in dry shaded woods, Moreton Bay." (*B. M. R.*, No. 30., April.)

*D. iórtile* Cunn. Perhaps a *Polystachya*. Found on trees 100 ft. high, Moreton Bay. (*B. M. R.*, No. 31., April.)

*D.?* *pygmaeum*, *D. Caléyi* Cunn. Found on rocks in Illawarra. (*B. M. R.*, No. 32., April.)

*D. elongatum* Cunn. "On trees in shaded dark woods, on the banks of the Brisbane River." (*B. M. R.*, No. 33., April.)

*D. ? crassulæfolium* Cunn. "Growing on trees in the ravines of the Blue Mountains." (*B. M. R.*, No. 34., April.)

*D. complanatum* Cunn. Growing in tufts on dead trees, and, though healthy, of a yellowish green. (*B. M. R.*, No. 35., April.)

*D. pugioniforme* Cunn. "A beautiful epiphyte, hanging loosely from the stems of trees, so as to swing freely in the wind." Found in Illawarra, and flowering in August. Nearly allied to *D. rigidum* R. Br. (*B. M. R.*, No. 34., April.)

*Iridææ.*

144. MA'RICA

1333a *gracilis* W. Herb. slender ♀  $\Delta$  or 2 au P.Y.W Brazil ? 1830. O 1.p Bot. mag. 3713

An elegant plant, a native of Brazil, from which country it was imported by the Duke of Bedford. It bears the greatest resemblance to *M. Northiana*, but is much more slender, and with smaller flowers. It requires the protection of a green-house. (*Bot. Mag.*, March.)

145. SISYRINCHIUM

*juncum* Know. et West. reed-like  $\frac{1}{2}$   $\Delta$  or  $\frac{2}{3}$  jn.l Li Chile 1832. O s.p Flor. cab. no. 95

One of the prettiest and most delicate-looking of the genus, raised in the Birmingham Botanic Garden, from seeds presented to that establishment in the year 1832, by Mr. Cuming. (*Flor. Cab.*, April.)

*Melanthæcææ.*

1120. MERENDE'RA 9163 caucásica Bot. Mag. 3690.

*Coníferææ.*

*Juniperus squamòsa*. This fine species of Indian juniper has been raised in the garden of the Horticultural Society. It appears to be quite hardy. (*B. M. R.*, No. 18., March.)

*Pinus oocarpa* Schiede. It is the same as the Ocote pine given out by the Horticultural Society. (*B. M. R.*, No. 23., March.) See *Arbor. Not.*, p. 129. and p. 237.

ART. XI. Account of a new Substitute for Tan and Stable Manure, in forming Hot-beds. Communicated by JOHN GRIGOR.

I HAVE received from Mr. John Stephen, gardener to Lady Saltoun, Ness Castle, near Inverness, an account of a substitute for tan bark or stable manure in the composition of hot-beds, which I consider worthy of being communicated to the public through the medium of the *Gardener's Magazine*, as, in many places, gardeners feel the scarcity of bark, and not unfrequently of stable manure also. The material recommended by Mr. Stephen is well known in Scotland by the name of *sids*, the husks of the oat, which are produced in the manufacture of oat-meal, and may be had in abundance at all the parish mills in Scotland.

Some time since Mr. Stephen observed that a quantity of this article, which had been discharged from a mill in his neighbourhood, continued to dissolve every succeeding shower of snow which fell on it during a protracted snow-storm; and, on examining it, he found it in a high state of fermentation. He had to make some hot-beds at the time, and he composed one of them entirely of *sids*, for the growth of melons, in the following

manner:— In a dry knoll a pit was dug of the ordinary size of a hot-bed; the stuff was watered and mixed up, the whole being made equally moist, and deposited in the pit; the surface mould and frame were placed in the usual way. The bed kept up a steady heat for six months, and from the circumstance of its not having been placed near the other frames in the melon ground, but in a remote corner, in case the experiment should have failed, it received less than ordinary attention; yet a very good crop of melons was produced, and the bed was but little reduced in bulk by fermentation.

Since Mr. Stephen has been so fortunate with a casual trial of this article, I hope it will soon become more valuable; for, at present, I am aware that it is a common practice at meal mills throughout the country, to throw the refuse into the mill-lead, that the stream may carry it off. Oats are always kiln-dried previously to their being ground, consequently the husks are to be had in the driest state. It may be expected, therefore, that when a person has had some experience in the operation of this material, that the requisite degree of heat, as well as its permanency, may be nicely adjusted by the quantity of water applied in preparing it for use. Should repeated experiments prove this to be the case, it is thought that this hitherto useless article will be of especial service to those who have to preserve half-hardy plants during winter.

*Forres Nurseries, April, 1839.*

---

ART. XII. *Notes, horticultural and agricultural, on the Brazils and New Holland.* By Dr. JOHN LHOTSKY.

WHEREVER Nature herself presents the aspect of a gorgeous garden, man does not pay much attention to horticulture. This fact admits only of some exceptions, in cases where civilisation has been carried to a high degree. Thus, it is obvious, that where amaryllises, fuchsias, &c., are growing wild at our very doors, we will not trouble ourselves with the care of rearing them in enclosed gardens, therefore horticulture, and still more floriculture, in the Brazils, is in a very indifferent state. The public gardens are either merely places of public resort (*Passejo publico*), or they are experimental gardens, for any given sort of new and useful plants; for instance, tea, cinnamon, or cloves, like that at Rio Janeiro. By the natural sympathy, however, which men always retain for their native shores, marigold, the wallflowers, and the mignonette, are grown by Europeans, in some of the gardens of the tropical part of the Brazils.

But, whilst floriculture, and the exhibition of artificially grown

flowers, are so rare in the above countries, a Brazilian market-place exhibits a profusion of products, beautiful in themselves; but especially unusual and surprising to the European traveller. Heaps of jacka (*Artocárpus integrifólia*), some of them as big as a pumpkin, with their rough reticulated skins; several kinds of custard apples, some of which, like *Frutta di Conde*, are of a very delicious taste; several kinds of *Eugènia*, and, among others, the pitanga, with its terebinthine flavour; and mangoes, are a few of the most striking and extraordinary. And, if we take into consideration, that all these are mixed up with heaps of pine-apples, twelve to fifteen sorts of oranges, lemons, and limes, together with sweet potatoes (*Ipomœa Batâtas*), bananas, common and water melons, and grapes, besides rose apples (*Eugènia Jámbos*), the massive brown tubers of yams (*Dioscòrea*), mandiocca, *A'rachis hypogœa*, cocoa nuts, and five or six other fruits of palms; and the vanille, the cacao (*Theobròma*), cuttings of sugar-cane, coffee, &c.; if we take all this into consideration, we might almost believe that the tradition of the gardens of the Hesperides was not purely an invention of the fancy, but based on solid reality.

But as it was not the intention of Providence, that nature should produce, and man enjoy, every thing in every place, the climate of the tropical part of the Brazils, and especially Bahia, is not adapted for growing the northern vegetables. In Bahia scarcely anything but radishes and lettuces, a few small carrots, and parsley, will succeed; and it is only in the latitude of Rio Janeiro that the roots of the carrots attain any considerable size. Potatoes never grow in Bahia, and even near Rio they are wretchedly bad. In the valleys of the Organ Mountains (4000 ft. above the level of the sea), Mr. G. Marsh of Liverpool has begun an English farming establishment; and at that height (the mean temperature of which may be about that of northern Italy), the northern culinary plants, even cauliflowers, are grown to great perfection, and sell at Rio for very high prices. In these valleys a number of English have established themselves; some of whom have obtained several square miles of land from the Brazilian government gratuitously, upon which they follow all sorts of rural pursuits. As the potato, notwithstanding the difficulty of procuring it, has remained a favourite dish with the million of white people in the Brazils, the few raised among the Organ Mountains are quite insufficient to satisfy so great a demand; and it will be new, perhaps, for some of my readers, to learn that large quantities of English and Irish potatoes are yearly imported into the harbours of the Brazils. These potatoes being conveyed in wicker baskets, through which the air can circulate freely, arrive in Brazil in a state of perfect preservation; and they are afterwards spread by the means of mules, or other conveyances, over the whole territory.



In changing the scene of my observations, from the tropical parts of the Brazils, to the colony of New South Wales, a new, and somewhat different, picture presents itself. Taking it with relation to rural economy, there can be no doubt, that the colony of New South Wales, extending as it does from 40° to the 28° of latitude, is capable of producing as many varied and useful plants as any other country in the world. Whether the sugar-cane will grow in the last-mentioned latitude is not certain; but coffee, St. John's bread (*Ceratonia Siliqua*), and the date palm will grow most undoubtedly; and, if we add to these the grape, the peach, and the fig, which are already cultivated there extensively, our previous assertion will be thoroughly corroborated.

Most of the culinary vegetables and fruits of Europe prosper in the different latitudes of the colonial territory of New South Wales; but it is upon subjects of somewhat greater importance that I wish to fix the attention of my readers on the present occasion. It is the growing of the vine, the olive, tobacco, and silk, which, if accomplished on a large scale, would increase the sphere of productiveness of the British empire. The vine has been introduced in New South Wales for many years; but it was Messrs. Allan Cunningham and Busby who endeavoured to push this sort of industry in a rapid and energetic manner. The former gentleman collected a great many cuttings in the British gardens, and Mr. Busby obtained at Paris an extensive collection from the Royal Gardens of the Luxembourg. I was present when this valuable collection was unpacked in Sydney, and saw that it arrived in a very good state. But when anything energetic or extraordinary is to be accomplished, it is often necessary that the original projector or inventor should carry his conception into execution himself. This was not the case with the above gentlemen, neither of whom were present, when the collection arrived. Notwithstanding some faults, which occurred afterwards, a great many cuttings were distributed, and the stock of vines considerably improved. Tobacco is grown extensively, and especially in the rich alluvial soil on the banks of the Hunter River, where it yields an abundant crop. It is remarkable, that a species of this questionably useful plant, with very tender leaves, grows wild in the colony. In the like manner, flax is found wild in the East Indies; an interesting fact in the history of vegetation. Mulberries are abundant about Sydney, both the common and the Cape species; so much so, indeed, that the former is used for hedges round gardens. And, finally, the olive is a plant which, agreeing with the mean temperature of the country, should do very well, but its cultivation has never been tried to any extent. All the above plants, however, requiring a kind of labour to which the English are strangers, can never prosper to any extent, without the colonists being instructed by those people

who, through the lapse of centuries, have acquired the practice necessary. I may take a credit to myself, that I was the first who urged the necessity of such tuition in a strong manner.

“Tobacco, with a most tender leaf, I found wild near Lake Macquarrie, and it is cultivated in great quantities at the Hunter River; but the colonists want Spanish, French, and American emigrants to collect the crops, and prepare the leaves. The culture of the vine has made great progress lately, especially since Mr. James Busby imported a superior collection of cuttings from Europe; but the colonists have no Spaniards or Rhenish people to undertake their cultivation, and prepare the wine. The olive, cotton, and white mulberry (as food for silkworms) grow well near Sydney; but this sort of field culture, like the previous one, will never prosper, unless the colonists be in the same way schooled by men of practical knowledge.” (*Illustrations of the present State and future Prospects of New South Wales*, p. 14. Sydney, 1835.)

There are two obstacles which, under the present circumstances of the colony, will ever mar the above most important improvements; and the first of these is the complete abrogation (since 1830) of granting land by government. Vine and olive planters, and tobacco and silk growers, must now be men of capital, and able to buy land at the very outset; but rich and enterprising men, generally speaking, do not emigrate. The second obstacle is of a more recent date. After I had suggested the idea of employing natives of the vine and olive countries to teach the culture of these plants, Dr. Lang went to the Continent, and engaged several hundred French and German vine-growers, who readily accepted his offers, because, at that time, the passage money, which was allowed by the colonial government to emigrants of the working classes, was to be given without difference of country; but these vine-growers had not even arrived in Sydney, when a despatch from the Colonial Office abrogated any grant of passage money to foreigners. This enactment, conjointly with the regulation compelling the purchase of land, will delay for a long time the culture of all the most valuable vegetable productions. What I would recommend is, that it should be stipulated, that, amongst the emigrants to whom passage money is allowed, a certain proportion (say the fifth or tenth part only) should be selected amongst foreigners. As the colony at the Cape of Good Hope is already exporting wine to England to a large extent, no one can say whether, under judicious regulations, New Holland might not do the same; and also export other commodities for which Great Britain is yet entirely dependent upon other countries.

*London, April 10. 1839.*

REVIEWS.

ART. I. *Royle's Illustrations of the Botany and other Branches of the Natural History of the Himalayan Mountains, and of the Flora of Cashmere, &c.* Part X., completing the work as far as p. 384. of the Illustrations of the Natural Orders; 10 coloured plates, folio. London, 1839. 20s.

OUR last notice of this work is in Vol. XII. p. 318., which was soon after the completion of part ix. Professor Royle apologises "for the very long delay" which has taken place in the appearance of part x., and which he states to have proceeded from his accepting the Professorship of Materia Medica and Therapeutics in King's College, and "the impossibility in which he found himself from being able to give the degree of attention which the work required, and had hitherto received." We are certain that all the purchasers of the work will approve of the delay, rather than hurrying the work to a conclusion, at the risk of rendering the latter part of it less complete than the first. A supplementary part, of which a great portion is prepared, will complete the work, which, as we have before stated, is unequalled by any other of the kind, for sound and comprehensive views.

Part ix. brought us to the order Artocárpeæ, under which there is much interesting information respecting caoutchouc, which is chiefly obtained from plants belonging to this order; though, to a certain extent, from plants belonging to Cichoræcæ, Lobeliæcæ, Apocýnæ, Asclepiàdæ, Euphorbiæcæ, and Urticææ, as already noticed in our preceding volume, p. 298, when reviewing Professor Royle's *Essay on the Antiquity of Hindoo Medicine*. In 1828, caoutchouc was an article unknown in the Calcutta market; but it is now so extensively used in England, that nearly 500 tons annually are imported from different parts of the world. It is singular that Mr. G. Livingston, late chief secretary to the Bengal Government, first directed attention in India to the caoutchouc, and also to the fact of the tea plant being abundant in Assam. "As the caoutchouc was pronounced to be of no value in the Calcutta market, so the tea was said to be only a camellia; and as the former has come to be so desirable an article for a commercial body here, so has the latter become an object of solicitude even to the Indian government." (p. 338.)

Caoutchouc, Dr. Royle observes, is a substance much more extensively diffused in plants than is generally imagined. It is found even in the spindle tree, the leaves of which are occasionally used for feeding silkworms, and which is nearly related to the holly, the birdlime of which is only a modification of caoutchouc. The number of plants suited for feeding silkworms, Dr. Royle suggests, may be increased by experimenting on those belonging to families which yield caoutchouc. The following facts are interesting:—

"From the fondness of birds for the fruit, and the tenacity of life in the seed, of *Ficus indica* and *F. religiosa*, are explained two phenomena very familiar to all who have visited India; one is that of a palm tree growing out of the centre of the banyan, and the other that of the pippuly (*F. religiosa*) vegetating (where the seed has been deposited in cracks) on the driest walls and most elevated domes and minarets, which, by its increase, it soon destroys. The former appearance, Dr. Roxburgh has also well explained, as proceeding from the seed of the banyan germinating on the moist upper parts of the palmyra tree (*Borassus flabelliformis*); and thence sending down its descending shoots, which, in time, entirely enclose the palm; this finally appears with only its bunch of leaves projecting beyond the top of the trunk of a lofty banyan, out of which it appears to be growing; though actually older, and, like it, having its roots fixed in the ground." (p. 340.)

*Broussonètia papyrifera* affords fibres which are convertible into ropes, made into a kind of cloth, or manufactured into paper. The wood is used

for dyeing yellow, as is that of *Morus tinctoria*, called fustic, and *Ficus tinctoria*.

*Ulmææ*, nearly allied to *Urticææ*, contains some species not yet introduced into England, such as *Ulmus integrifolia*, *U. lancifolia*, *U. erosa*, *U. lævigata* Royle, and *U. virgata*. Some species of *Celtis* also remain to be introduced.

*Juglândææ*. — *Juglans regia* extends from Greece and Asia Minor, over Lebanon and Persia, to the Himalayas. *J. arguta*, found by Dr. Wallich in Taong Dong, is not yet introduced into England. The Arabs call the walnut "the nut," and the Persians the "four brains."

*Amentâcææ*. — A number of species belonging to this order are mentioned, none of which are yet introduced, though, from the elevated localities in which they are found, several will doubtless prove hardy in this country.

A reduction will take place, Dr. Royle observes, in the number of Himalayan oaks at present enumerated; all of them varying much in appearance. *Corylus lâcera* abounds on the highest mountains, with *Carpinus viminea*. Several species of *Alnus* and *Betula* are mentioned, which, as we have stated in the *Arb. Brit.* (Dr. Royle having kindly lent us the proof sheets of this part of the work while they were passing through the press), would be most desirable introductions.

"The willows, diffused in distribution, are also multiform in habit; the species peculiar to the Himalayas are not found easier than others of discrimination. As they occur both in warm and cold parts of the world, so we have them both in the plains and mountains of India. *Salix babylonica* is common in gardens in Northern India, as is *S. ægyptiaca*; while the polyandrous *S. tetrasperma* Roxb. is found in the Kheree Pass, along the foot of the mountains, and in other hot parts of India, as Bengal and the Peninsula. A species of this genus, as we have seen, is common also on the Senegal. We know that a dwarfish willow (*Salix arctica*) extends to, and forms the only woody plant of, high northern latitudes; so the diminutive *S. Lindleyana* is found on the loftiest parts, or between 12,000 ft. and 13,000 ft., of such mountains as Kedarkanta; with *Rhododendron lepidotum* and *anthropogon*, the only other ligneous plants. *S. hirta* and *retundifolia* nob., from Kunawur, resemble, the former *S. hastata*, from Lapland, and the latter *S. polaris* and *S. herbacea*.

"The poplars are confined to the northern hemisphere; we find them flourishing on the Himalayas only at considerable elevations. *Populus ciliata* [a new species, of which a figure is given], found in Kemaon, is common on the northern face of the Choor, at Muttiana, and at Seran in Lower Kunawur. *P. pyriformis* nob. occurs in Deobum. *P. alba* Lin., common in Europe and the north of Asia, extends to the north of the Himalayas, as I have had specimens brought me from Kunawur. The native country of *P. dilatata*, or the Lombardy poplar [*P. fastigiata* Arb. Brit.], seems to be quite unknown, some authors considering it a native of Italy, and others of America, while some even account it a hybrid. But, from the following facts, I think there is little doubt of its having been brought to Europe from some Eastern country in former times, when the communication by the East, and interchange of commodities, was greater than in recent times. Understanding that a tree which, from the description, appeared to be a poplar had been introduced from the Punjab, and was common in gardens to the north of the Jumna, I sent for it into the Saharunpore Botanic Garden. The slips obtained grew well, and the plants were ten or twelve feet high, with the habit of the Lombardy poplar, when I left Saharunpore; the specimens in my herbarium were immediately recognised by Mr. Don as those of *P. dilatata*. The *ghurh* [the Indian name], or Lombardy poplar, is said, in Persian works, to be a native of Dailim and Tinkahoon, near the south shore of the Caspian. Mr. Bailie Fraser, I understand from Mr. Don, says it is one of the most common trees in Persia, and is that usually taken for the cypress in Persian drawings." (p. 344.)

"The oaks, chestnuts, and others of the *Amentacææ*, are so well known for their rich and luxuriant growth, and as forming the ornaments of European

forests, that we can hardly fancy the so-much boasted trees of tropical regions to be more magnificent. One thing is certain, that they do not furnish more valuable timber, whether we consider the English oak, or those found in the Himalayas. (*Ibid.*)

*Quercus Ballota*, probably described in Persian works under the names shah-bulloom, and bulloom-ool-mulik, having acorns free from tannin, they have been long used as food; and, with *Q. Süber*, might be naturalised in the plains of Northern India. The hazel is abundant in the Himalayas, and the nuts are found every where in the Barjars.

The bark of *Bétula álba*, reduced to powder, as well as the wood of the black poplar, is eaten by the inhabitants of Kamtschatka, beaten up with the ova of the sturgeon. Cattle are fed on the leaves of *Pópulus nigra*, and the coma of the seeds is employed for making paper. That of the Himalayan *P. ciliata*, being particularly abundant, might be employed for the same purpose. *Sális ægyptiaca*, the calif, or Egyptian willow, has a fragrant water distilled from its catkins. We pass over several orders to the

*Coníferæ*. — Under this order Dr. Royle includes the *Abiétinæ*, *Cuprèssinæ*, and *Táxinæ*. Species of almost all the genera belonging to these orders are found in the Himalayas. *Cuprèssus sempervirens*, *C. pèndula*, and *Thùja orientális* succeed in the gardens of the north and of the south of India. *Podocarpus latifolius* occurs in the mountains of Silhet, and *P. macrophýllus* in Nepal. The species of *Pínus* found at the lowest elevation is *P. longifolia*, allied to *P. canariénsis*. *P. excélsa* is remarkable for its drooping branches, whence it is frequently called the weeping fir, by travellers in the Himalaya: it is found with the *Deodara Narainhetty*. Both these noble trees are quite hardy in the climate of Britain. We pass over other interesting matter, already given (through the kindness of Dr. Royle, as we have before mentioned) in the *Arboretum Britannicum*. Dr. Royle observes, in a note, that the cone lately brought from the Himalayas, by the collector of His Grace the Duke of Devonshire, and figured in our *Arboretum*, p. 2236, probably belongs to a variety of *P. Pináster*, commonly called *P. nepalénsis*, which we have recorded in the *Arboretum Britannicum*, p. 2217.

*Musàcæ* (from *Moy*, the Arabic name for the plantain).—This order is extensively distributed in the tropics. All the cultivated varieties are probably derived from the *M. sapiéntum*, of which the original is the wild *Musa* described by Dr. Roxburgh, as raised by him from seeds received from Chittagong.

“The plantain and banana, therefore, must be natives of Asia; and no plants can more strikingly display the benefits derivable to one country, from introducing the useful productions of another which is similar in climate, as these are extensively cultivated in America, and as high as 3,000 feet of elevation in the Caraccas. The banana, as Humboldt has remarked, is, for the torrid zone, what the Cerealia are for Europe and Western Asia, or rice for Bengal and China, and forms a valuable cultivation wherever the mean temperature of the year is about 75°. A single cluster often weighs nearly ninety pounds. Humboldt has calculated that, in the space of a year, 1,076 square feet of ground yield more than 4,000 lbs. of nutritive substance; and that the same space will support fifty individuals, which will not maintain more than two when planted with wheat.” (p. 355.)

*Marantàcæ*. — This order is remarkable for the quantity of fecula which is stored up in “the rhizomata, or the so-called roots, of several species, which, in its prepared state, is so well known under the name of Indian Arrow Root. This is obtained in the West Indies from *Maranta arundinacea*, *Allouyia*, and *nobilis*; also from *Canna glauca*, called ‘tous les mois;’ and in the East Indies, from a species of *Curcuma*, as well as from *Maranta ramosissima*, a new species found in Silhet. But it has of late years also been prepared, of fine quality, from *M. arundinacea*, grown in their gardens by the Horticultural Society of Calcutta; and was so, many years ago, by the late Sir W. Ainslie, from plants grown in his garden, near Madras. It might, no doubt, be success-

fully introduced into many other parts of India. The leaves of *Calathea* are employed in making baskets in South America; so the split stems of *Maranta dichotoma*, being tough, are employed in India in making the so much celebrated *sital-pat*, or Calcutta mats (*Fl. Ind.*, i. p. 2.)" (p. 356.)

*Scitamineæ*, or *Zingiberacææ*. — Much interesting matter belonging to this order we must necessarily pass over to the

*Orchidææ*. — This order is treated at greater length than any other in the work; and the growers of this splendid family of plants will find part x. of Royle's *Illustrations* worth purchasing for this order alone. We can only spare room for the following introductory paragraphs: —

"The *Orchidææ*, named from a European genus, are yet most numerous in tropical countries. Allied to the *Marantacææ* and *Zingiberacææ*, like them they are remarkable for irregularity, and still more for their diversity of form, but are distinguished by their stamen and pistil being united into a column. The peculiar organisation of *Orchidææ* having been first elucidated by Mr. Brown; their systematic arrangement into genera and species has only recently been fully accomplished by my friend, Dr. Lindley, to whom I am indebted for the examination and naming of all those in the present collection; and to his work, for many of the facts in the following observations, which are arranged in conformity to his division of the *Orchidææ* into the tribes *Malaxideææ*, *Epidendreææ*, *Vandææ*, *Ophrydeææ*, *Gastrodiææ*, *Neottieææ*, *Arethuseææ*, and *Cypripediææ*.

"The *Orchidæææ*, whether epiphytal or terrestrial, are found in all parts of the world, which are not very cold nor very dry. Warmth and moisture being most congenial to them, they are necessarily most abundantly diffused within the tropics; but species extend beyond these limits, as *Malaxis paludosa* to the north of Europe, and *Calypso borealis* even to 60° and 68° in both the Old and New World. The most southern stations of the epiphytes are those of *Earina mucronata* in New Zealand, in lat. 35° S., and of *Gunnia australis* in Emu Bay, Van Diemen's Land, lat. 41° S. Though found in greatest numbers in the moist valleys at the foot of mountains, several ascend them to considerable elevations, and were discovered by Baron Humboldt at elevations of 7,000, 8,000, and 9,000 ft., in the Andes of Quito and Granada; while *Oncidium nubigenum* occurs as high as at 14,000 ft. in the Andes of Peru. So I found *Dendrobium alpestre* at 7,000 ft., and *Cœlogyne præcox* at 7,500 ft. of elevation on the oaks of Mussoree and Lundour, in 30° of N. latitude.

"From this extensive distribution it would appear that there was not the same connexion between structure and climate, as we have seen to exist in most other families. But this may be an apparent, rather than a real exception. Many of the *Orchidæææ*, being provided with tuberous roots, have these, from their underground situation, protected from the vicissitudes of temperature, and, as they often exist in moist situations, and flourish during the summer temperature, a kind of local climate may be supposed to be produced, in which a less degree of temperature appears to be necessary. Thus, on the mountains of hot countries there is constant humidity in the rainy season, 'from the air charged with moisture in the heated valleys, rising and depositing it on the mountains, when it reaches an elevation where it is cooled beyond the point of saturation;' and this being accompanied with equability, we have two of the characteristics of a tropical climate, and find a lower degree of temperature fully sufficient for the most luxuriant growth of many tropical genera and families of plants, with numerous terrestrial and the above named epiphytal *Orchidæææ*." (p. 362.)

We conclude for the present with the following note: —

"The *Bromeliacææ*, or pine-apple tribe, are so exclusively an American family, that nothing but the extensive diffusion of the pine-apple over India would render advisable their mention here. The introduction into India of the pine-apple is expressly mentioned by Indian authors, as by Abul Fuzl, in the *Ayeen Akberry*, and then by the author of the *Dhara Shekoih* (*Taleef*

*Shereef*, transl., p. 18.). It was introduced into Bengal in 1594, by the Portuguese, during the reign of Akbar, and is called by the natives either *ananas* or *kutt-suffur* "artocarpus for a journey," as its fruit ripens even when carried about. Pine-apples succeed as far north as 30° in the open air; but are plentiful in the garden of the Taj-muhul at Agra. They are so abundant in Ceylon, and near Rangoon in Burma, as to appear wild in both places, and are considered most delicious in flavour in the latter situation. They are mentioned by Captain Turner, in his Journey to Teshoo-loomboo, as extremely abundant in the jungly tracts in the entrance to the hills. It is evident, therefore, how well suited the climate and soil of many parts of India are to the cultivation of the pine-apple. This is important, not only on account of its fruit, from which a very agreeable beverage is in some countries prepared, but also on account of the fibre which abounds in the leaves, and which has attracted a good deal of attention in this country; as with it cloth has been manufactured as fine as some muslins. (See our Vol. XIII. p. 461.) The natives of India appear to be well acquainted with the fibre of the pine-apple leaf, as some of very good quality, and light-coloured, has lately been sent from Bombay to the Royal Asiatic Society. Some years since, Mr. Cracroft, also, sent from Dacca, to the Asiatic Society of Calcutta, specimens of pine-apple fibre prepared in the Barycote district." (p. 376.)

We again strongly recommend this work, not only to botanists and horticulturists, but to readers generally, as full of instructive matter, agreeably placed before them, on subjects in which all are interested.

---

ART. II. *Second Annual Report and Proceedings of the Botanical Society.* Session 1837-8. 8vo, pp. 90. Edinburgh, 1838.

THE first Annual Report of this Society was noticed in Vol. XIII. p. 507., and was chiefly to be considered as indicating its commencement and plan. The *Second Report*, now before us, exhibits the working of the Society, and the kind of good which it is likely to effect. Independently altogether of the advancement of botanical science, the good feeling and friendship called forth, or fostered, by the personal intercourse or written correspondence of so many minds occupied with the same pursuits, are alone sufficient to entitle the Society to public approbation. It will, however, do much more than this, as will appear by some of the extracts which we shall give from its last year's *Proceedings*.

The number of members of the Society is steadily increasing, and of these several are eminent foreigners. The total number of members up to October, 1838, is 199. The first paper of general interest is entitled

*Extracts from a Report of the Progress and State of Botany in Britain, from February, 1837, to March, 1838.* By Professor Graham. — In introducing the subject, it is stated that the data on which the report is founded are the botanical papers in the British periodicals, including those translated from foreign languages, as well as original papers of British authors. The first subject is,

*Vegetable Organisation.* — The subject of vegetable metamorphosis is said to have been anticipated "by the tolerably clear ideas of Linnæus;" and afterwards accurately investigated by Wolff, previously to its being brought into notice by Goethe. Wolff's writings, however, were forgotten; while Goethe's, after a time, procured the attention of botanists. The microscopic structure of the fibre of cotton, flax, and hemp, has led to the conclusion, that all the cloths wrapped round the mummies of ancient Egypt are of flax, and, consequently, that cotton was unknown to the Egyptians.

*Botanical Classification.* — Sir E. F. Bromhead's paper, noticed in our Vol. XII. p. 458., is dismissed with the following remark, which we give as characteristic of the professor's manner of treating subjects of this kind: — "His

remarks are very brief, and the table of his alliances is unaccompanied with any characters. The author has evidently given himself a great deal of trouble with the subject, and his paper, therefore, merits a very careful examination ; but the very first aspect of the table will appear most forbidding, and the grouping extremely unnatural." A paper in the *Magazine of Natural History*, for August [vol. x. p. 421.], on the Propriety of a Descriptive Nomenclature, is noticed, with a remark of a similar kind. The following extract is curious :—

"If I could believe, which I certainly cannot, the transformation of oats into rye, these changes in specific identity would indeed sink into nothing ; but the evidence has accumulated so much round this often-told tale, that it has at last been admitted into a British scientific journal. The subject is noticed in the *Magazine of Natural History* for November last, and some observations made, in order to rub a little off the *primâ facie* absurdity of the position, and induce a repetition of the experiment. The experiment is a very simple one. It has been asserted during many years, and from various countries, that if oats be cut down repeatedly, so as to prevent their flowering during the year that they are sown, the same roots will next year produce a crop of rye. Mr. Hancock, in the June number of the *Magazine of Zoology and Botany*, notices the near identity of *Tamus communis* with *Dioscorea*, and doubts whether it can be even specifically distinguished from *Dioscorea cajanensis*."

*Plants which, during the last Year, have been added to the British Flora.*—*Bétula intermèdia*, a rare plant on the Jura, and differing essentially from *B. álba*, has been found on the Clova Mountains. [Not considering *B. intermèdia* as specifically distinct from *B. álba*, though we allow it to be a good variety, we should feel much obliged to Colonel Brown (at one time our correspondent) for a few seeds.]

"The necessity of concluding these remarks prevents me doing more than merely referring to the different British periodicals during the last year, for descriptions of a number of highly interesting new plants, by Lindley, Hooker, Arnott, Don, Henslow, and others. The order which, in cultivation, is attracting most attention at present, is the Orchideæ, and the splendid, grotesque, and innumerable tropical parasitical species which have lately been introduced into our stoves certainly are most attractive. I have always expressed my fears that, attention having only lately been given in earnest to this race, we had not yet acquired that amount of knowledge regarding it which warranted the great subdivision of forms into genera and species, which are daily in the course of publication ; and that these fears were not groundless, is shown by the acknowledgment of Professor Lindley, than whom no one is a more competent judge, from the unremitting attention which he has paid to the subject. In April last, he published the figure of a plant which combined in its own person no fewer than three supposed genera, and he winds up his observations with these expressions :—'The necessary consequence of this is, that the supposed genera *Myanthus* and *Monachanthus* must be restored to *Catasetum* ; and I have no doubt now, although no proof has been seen of it, that *Mormodes* must share the same fate ; but which of the species have their masks on, and which show their real faces, I certainly will not, at present, presume to guess.' The important lesson to be learned from this is, that, in little-known tribes, we must accumulate observations before we can be competent to form generic or specific characters. With the Orchideæ, perhaps, we could scarcely help taking steps prematurely, because these plants were altogether new, and required to be somehow arranged ; but where a station and a name have been already assigned, even obvious, if established, blunders should be allowed to remain for a time, rather than run the risk of multiplying error by premature change."

The discovery of *Victoria regalis* is noticed under this head, though the plant cannot be considered as added to the British flora in any sense. "Were we quite certain of its specific identity with Pöppig's plant. It would, no doubt, be consistent with strict propriety to restore his specific name, ama-



zonica, though a bad one ; but, as it is not very unreasonable, in the circumstances, to doubt this, our loyalty will not allow us to part with the specific name either." (p. 36.)

*Botanical Geography.* — Some papers in different journals are noticed, and the following useful abstract given from Link's *Botanical Geography of Southern Europe*. "Link divides the south of Europe into three regions, from north to south, severally characterised by *Lavandula Spica*, *Myrtus communis*, and *Nerium Oleander*. From west to east, he also divides the south of Europe into three regions, distinguished by the pines and the oaks. The *Pinus Pinaster* extends from Portugal as far as Genoa; the plains of Italy are characterised by the *Pinus halepensis*; and to the eastward of the Adriatic is a small fir [*P. Pinaster minor*] called by Link *Pinus maritima*, but altogether different from the *Pinus maritima* of De Candolle, which he considers the same as the *Pinus Pinaster* of Lamarck. The very same regions, from west to east, are severally characterised by the *Quercus Ballota*, a *Quercus* which Tenore considers a variety of *Quercus pedunculata*, and the *Quercus Ægilops*, all of which have edible fruit." (p. 36.)

*Vegetable Physiology* occupies little more than a page; and, for the omission of *Vegetable Chemistry*, we have the following apology:—

"Gentlemen, there are various other subjects to which it was my duty to have adverted in the sketch which you desired me to prepare; but I am very much ashamed of the length to which it has already gone, and I too much admire your patience to think of punishing by farther taxing it."

In the next paragraph the subjects thus necessarily omitted are hinted at; and we quote the passage, because it may recall to the mind of the reader something of what he may have read during the past year in scientific periodicals, foreign and domestic:—

"Among the subjects which I have thus necessarily omitted, but which have received more or less of notice in Britain during the last year, are the progress of phytochemistry, the existence of salts in an organised state, the reported erosion of glass by cryptogamic plants growing on its surface, the formation of vegetable products, the formation of soils, observations in fossil botany, and the nature of the plants which are thought to have clothed the earth at different epochs in the world's history, with what I conceive to be the most mistaken attempts, by high authority, at an explanation of the enormous development of certain cryptogamic plants at a very remote period. I should also have noticed some interesting experiments by Göppert, in illustration of the manner in which petrification may be supposed to take place; but all these matters I must omit, having only named them to show the multiplicity of subjects into which our science has been found to ramify, and the boundless petrification to which its culture will certainly lead."

On the whole, this paper does not appear to us to be judiciously drawn up. The different subjects which it embraces are not treated in due proportion to their importance; and some of the most intense interest, as we have seen, are altogether omitted. The remarks of Professor Graham, where he does make any, are too often frivolous; and with respect to the apology for omitting vegetable chemistry; viz., because he was "already ashamed for the length he had gone," &c., we consider it ridiculous. A report of this kind should be maturely considered before-hand; and the extent of every part adjusted according to its importance, and to the magnitude of the whole. The report is stated to be an abstract; but this seems to be a misnomer, for the introduction and the terminating paragraph are given in the first person, evidently as delivered by the professor to his audience. Indeed, this may be said of the greater part of the article. It would be easy to add to remarks of this kind, but we have borne in mind the following observations of the professor. Speaking of Dr. Schleiden's article on the Development of the Organisation in Phanogamous Plants, he says:—

"There is occasionally a little asperity in the paper, which, though used on the right side, is not pleasant; and were I at all apprehensive that it would be

followed by the members of the Botanical Society, I would urge them to recollect that it is very unbecoming in investigating a science which every where abounds with proofs of universal benevolence, and that it is calculated to do any thing rather than beget that kindness of feeling which is necessary to produce the mutual cooperation so necessary for eliciting truth in the investigation of nature, regarding the operations of which a very moderate share of humility would show that all are lamentably ignorant."

In referring to the different periodicals, Professor Graham invariably mentions the number, or the month, seldom the year, and never the volume; a most unbusiness-like mode, to say the least of it, because it will occasion considerable inconvenience to those who wish to turn to the papers to which he refers, after the periodicals referred to are done up in volumes. In one word, when Professor Graham undertook to give this report, which will be looked to by Continental botanists as of importance, from its being the production of a Regius Professor in one of the most celebrated of our universities, he placed himself in a false position.

*Proceedings of the Botanical Society.* — The papers which appear to have been read at the different meetings embrace a variety of botanical subjects; and some of them, had they been given at length, are of considerable interest to the gardener.

July 13. 1837. — "Mr. J. M'Nab read an extract from his Journal of a Tour through Canada and the United States, during the summer of 1834, containing a highly interesting account of an excursion to the Falls of Niagara, with particular reference to the botanical features of that celebrated locality. The arbor vitæ (*Thuja occidentalis*) was observed to be exceedingly abundant in the neighbourhood of the Falls, overhanging the rapids in many places in the most curious manner. Drawings were exhibited of some specimens of this tree, which had sprung up in a very singular way. Several large lime trees had been cut down, many years ago, about two feet above the ground; and, after decay had commenced, some seeds of arbor vitæ had got into the centre of them, where they had germinated, and now formed beautiful and handsomely shaped trees, upwards of twenty feet in height, with stems twenty inches in circumference. The deciduous trees chiefly consisted of platanus and tulip trees, oaks, elms, limes, ashes, walnuts, beeches, birches, and poplars. The herbaceous vegetation was very luxuriant, and presented many rare and interesting species. The exposed rocky ground above the Falls was richly adorned with dwarf shrubby plants, of which the *Hypericum Kalbmanum*, then in full flower, was the most conspicuous, whilst the swampy grounds were profusely covered with the beautiful scarlet and blue cardinal flowers (*Lobelia cardinalis* and *siphilitica*.) *Impatiens biflora* was remarked as the plant growing nearest the descending water of the Falls, being constantly within the influence of the spray, and assuming a tall and spongy habit, without any appearance of flowers. On Goat Island, which separates the American from the British Fall, the herbaceous plants were very various, including *Hepaticas*, *Trilliums*, *Cypripediums*, &c.; also *Sanguinaria canadensis*, *Hydrastis canadensis*, *Podophyllum peltatum*, *Arum triphyllum*, *Jeffersonia diphylla*, *Symphoria racemosa*, &c. &c."

*Effects of the Winter of 1837-8.* — "Dr. Graham stated that, in consequence of the early, long-continued, and severe winter, a very considerable number of half-hardy shrubby plants in the Botanic Garden had been more or less injured; and that he proposed exhibiting in a tabular form the extent of the injury, distinguishing the plants according to their native country, their natural orders, and the situations they occupied in the garden, whether upon walls or in exposed or sheltered borders. He mentioned, at the same time, that, in consequence of the much greater quantity of snow than usual, herbaceous plants had sustained little injury, and gave as an example the *Roscoea purpurea*, one of the *Zinziberaceæ*, which had lived in the open border without protection during several winters, and flowered freely each summer."

Nov. 9. 1837. — Dr. Graham exhibited drawings and gave an account of several remarkable forms of trees which he had recently seen and examined.

The first was a small Scotch pine, suspended from a much larger tree by adhesion to its side, in the M'Nab burying-ground, at Killin. This is evidently an accidental graft, similar to that discovered in an old thorn hedge, by Mr. John Wallis; and from which he concluded that "vegetables derived their nutriment independently of the earth." (See our Vol. X. p. 51.) The second monstrosity is, the apparent union of a horsechestnut and beech, at Cambusmore, near Callander; and the third is at Gargunnoch House, Stirlingshire. It consists of two broad-leaved elms, growing so near together, that they might be supposed to rise from the same root; while there is squeezed in between the stems an ash, and three hollies. Of course, there are abundance of local legends accounting for the origin of these apparently unnatural unions, which the slightest knowledge of vegetable physiology will enable any one to detect as having no foundation in truth.

Jan. 11. 1838. — Mr. R. W. Falconer read a paper on the ancient history of the rose. This paper we should much like to peruse. An abstract of it is given, but it is much too short to be of interest to our readers. Mr. Edwin Lees of Worcester sent a communication on the *Pÿrus domestica*, or the Whitten pear tree of Wyre Forest, in the parish of Rock, in Worcestershire, about three miles from Bewdley. It agrees with what we have stated in the *Arb. Brit. and Sup.*, on the authority of Lord Mountnorris, Mr. Pearson, and some other local correspondents. Mr. Lees estimates the age of the tree at 400 years. "The vestiges of a habitation and garden, he thought, might be traced in some bricks and remains near the spot; and in the presence of solitary specimens of *Ligústrum vulgare* and *Prúnus domestica*, the only ones which he observed in the whole forest." "Fruit is produced annually, and is eagerly gathered as a curiosity by the country people, who look upon it as a charm, suspending it in their habitations, and appearing to consider it a safeguard; while to the mountain ash, *Pÿrus aucuparia*, they pay no sort of attention, although they seem aware of the relationship between the species, designating the latter the whitten tree, the former the whitten pear tree."

February 8. — Mr. R. W. Falconer read a paper containing an account of the most celebrated gardens of antiquity, with observations on the hortulan taste which they exhibit. From the short abstract given of this paper, it appears to resemble one on the same subject, printed many years ago, in the *Memoirs of the Philosophical Society of Manchester* (vol. i. p. 297.), and subsequently in a separate volume, dated 1783, by Dr. W. Falconer.

Mr. James Macauley read a paper on the culture of flowers by the ancients; in which, among other things, he showed, that the garden of Lucullus, so often referred to, cannot be regarded as a specimen, either of the art, or the taste of his time; in as much as it was censured by his own contemporaries (*Cic. de Leg.*, iii. 13.); and Varro expressly states, "*Hortos Luculli non floribus fructibusque sed tabulis fuisse insignes.*" The gardens of Lucullus were distinguished, not by their flowers and fruits, but by their pictures. [The inference from Cicero is, that the villa of Lucullus was stuffed with pictures and statues.]

April 12. — Mr. Hamilton read a paper on the Gardens of the Ancient Hebrews. This we should like much to see.

Professor Christison made some observations on the preservation of fruits and other botanical specimens in a moist state. After numerous experiments made "with various fluids, he had found none which served so well to preserve both the consistence and colour of fruits, leaves, and flowers, as a concentrated solution of common salt. The solution should be made with the aid of a boiling heat, otherwise it can with difficulty be obtained sufficiently concentrated. When articles are to be sent to a distance, as when specimens are transmitted from hot climates to this country, the best mode of putting them up is to preserve those which are of small size in greenglass bottles, such as are used for pickles, to fill the bottles with the solution, and to secure the corks with a covering of some resinous substance, and cloth tied over all. But the cheapest and most effectual mode for larger articles, and, indeed,

for botanical specimens generally, is to sew up each in cloth of any kind, with a wooden or tin label attached to it, and to put the whole in a barrel, containing the solution of salt, and of such size that the specimens are loosely packed, and yet cannot easily change their position. He has frequently received specimens sent in this way, in a state of complete preservation, from Ceylon, the Isle of France, and the West Indies, although four or six months elapsed before they reached their destination.

“Solution of salt is comparatively inapplicable, however, where the fruit is very pulpy; in such fruits, for example, as *Solanum Lycopersicum*, or lemons and oranges; because the fruit shrivels by exosmosis of its fluids. Diluted pyroligneous acetic acid, diluted to the density of 1008, sometimes answers well in such circumstances; but after a few years the texture of the specimens becomes so pulpy and brittle, as not to admit of their being handled, and most colours are in no long time more or less altered. Spirit, which is most generally used, speedily renders all colours alike brown.”

May 10.—“Mr. Macaulay read the first part of a paper ‘On the Effects of Vegetation on the Atmosphere,’ in which the influence of the vegetable kingdom on the *composition* of the atmosphere was treated. After detailing various experiments, tending to show that different natural families may differ in their effects on the atmosphere, and giving an abstract of the researches of Priestley, Senebier, Berthollet, Ellis, Saussure, Burnet, Morren, Daubeny, and others, Mr. Macaulay concluded by presenting a series of propositions, which appeared to him to contain the present state of our knowledge on this subject. A statement of the results of the enquiry will be given along with the abstract of the remaining part of the paper, in which the influence of the vegetable kingdom on the *Temperature, Moisture, and Electricity* of the atmosphere will be treated.” This promises to be a most valuable paper, and we could wish to see it published at length.

The list of contributors to the herbarium comprises a great many names, among which is included that of W. Christy, jun., Esq., F.L.S., who presented the Society with about 8000 species and 15,000 specimens. This gentleman is also one of the contributors to the library, and his donations amount to upwards of 60 different works, many of them of great rarity and value. These are magnificent donations, worthy of the excellent individual by whom they were made.

The main object of the Botanical Society is the intercommunication of dried specimens of plants; and though, to many, this may appear a matter more of amusement than of use, yet, to all who wish to know the names of plants when they see them, we consider dried specimens of very great importance. However accurately plants may be described by botanists in books, we can never be quite certain in the application of their description, without the aid of a dried specimen or a coloured figure; except in those cases where the enquirer already possesses a knowledge of the majority of species of the genus to which the species belongs that he is examining. Collecting and drying specimens, even though the names are not known by the collector, is a very excellent mode of acquiring a taste or desire for botanical knowledge; and when once any person has dried a few specimens himself, so as to have an idea of the changes which they undergo in this process, he may acquire the names of a great many plants, and be able to recognise them in a living state, merely from recollecting their appearance in his herbarium, or in his coloured plates. It is true, that knowing the names, and being able to apply them to the plants, is nothing more than an index to their history, properties, and uses; but every one must allow that the possession of this index is of the greatest practical value. The intercommunication of specimens among botanists is, therefore, of great use to them; and if those who are only beginning to study botany had an opportunity of purchasing abundance of specimens correctly named, it would contribute greatly to their advancement in the science. It will be seen from these remarks, that we highly approve of this Society, and would advise such gardeners as have an opportunity of collecting and drying specimens to belong to it.

ART. III. *Pinetum Woburnense*; or, a Catalogue of Coniferous Plants in the Collection of the Duke of Bedford at Woburn Abbey: systematically arranged. Royal 8vo. Not published, and only 100 copies printed. 1839.

IN order that our readers may learn the causes which have led this amiable and enlightened nobleman again to appear as an author, we make the following quotation from the Introduction:—

“It is now eight years since I printed my ‘*Salictum Woburnense*; or a Catalogue of Willows at Woburn Abbey;’ and at that time I little thought that I should again have recourse to the press, even in the humble and unambitious work of enumerating the specimens of another genus of plants in my collection; but I have been induced to resume my occupation, partly for my own amusement, and partly in the hope of gratifying those amongst my friends who take an interest in such matters.

“After printing my list of willows, my health was seriously affected; but it has pleased God so far to restore it, as to enable me to engage again in one of my most favourite pursuits—the study of nature, in the productions of the forest, the garden, and the conservatory; and I have derived much pleasure in arranging a catalogue of all the plants which I possess, connected with the genus *Pinus*, and attending its progress through the press.

“That interesting tribe has lately engaged much of the attention of the most zealous and enterprising of our horticulturists. The splendid work of Mr. Lambert (on the genus *Pinus*), in two volumes folio, is well known, and highly appreciated; and he has lately added a third volume, full of valuable and interesting information.

“That eminent statesman, and truly estimable man, the late Lord Grenville, found solace and pleasure in his retirement from the cares and anxieties of public life, in investigating the *habitats* and culture of various genera of trees; and the *Pinetum* formed by him at Dropmore is now allowed to be the most complete of any in Great Britain.

“A short time previous to his decease, on sending me some rare specimens of pines, which I had not then in my own collection, he wrote me a most friendly and encouraging letter, expressing the pleasure which he felt at learning that I had turned my attention to the cultivation of this truly interesting genus; from which he himself had derived so much satisfaction. I had previously received from that excellent person a very gratifying letter, acknowledging the receipt of a copy of my *Salictum Woburnense*.

“There is, perhaps, no tribe of plants, not excepting even the oak, which claims more admiration than the genus *Pinus*; nor any that brings with it so many pleasing recollections or associations of thought.

“In the Holy Scriptures, which abound in sublime and beautiful allusions to the woods and the forest scenery of Syria and Palestine, the various species of the pine tribe stand eminently conspicuous. Speaking of Israel, the chosen people, David says, *His boughs shall be like the goodly cedar trees; he shall flourish like a palm tree; and spread abroad like a cedar in Lebanon.* Psalms, lxxx. & xcii. And when in the 72d Psalm, he speaks of their works of righteousness, he says, *Their fruit shall shake like Lebanon*; he alludes, probably, to the cones which hang in clusters from the lofty cedars of that mountain. And the prophet Ezekiel, in speaking of the vastness of the power, and the extent of the dominion and majesty of the great king of Assyria, says, *The Assyrian was as a cedar in Lebanon; I made him fair by the multitude of his branches; so that all the trees of Eden, that were in the garden of God, envied him.* In the 41st chapter of Isaiah, Jehovah says: *I will plant in the desert the cedar, the fir tree, and the pine, the glory of Lebanon.*

“We have, also, many classical authorities for venerating the fir tribe. Statius says,

“—— ‘*Sylvarum gloria, pinus.*’ *Sylv.* 151.

[The pine, the glory of the woods.]

And Horace, in similar strain, says,

“ ——— ‘ Pontica pinus,  
Sylvæ filia nobilis.’ HOR. I. Carm. xiv. 11.

[“ A noble daughter of the Pontic wood.” *Francis’s* trans.]

But the boldest epithet is that applied by Statius, in the 6th book of his *Thebaid* :—

‘ Hinc audax abies, et odoro vulnere, pinus.’ STAT. *Theb.*, iv.

[“ The pine that breathes forth fragrance from each wound.” *Lewis’s* trans.]

“ This expression forcibly brings to our mind the Glenmore and Atholl and other fir frigates, built of the magnificent Scotch firs (*Pinus sylvestris*), of the Forest of Glenmore, and of the gigantic larches (*Larix europæa*), imported into Scotland by the Duke of Atholl, and now abounding in the Highlands.”

“ I have again had recourse to the extensive and accurate botanical knowledge of the able superintendant of all my garden concerns (Mr. James Forbes), to assist me in forming a catalogue of such specimens of this most interesting family of plants as I possess at Woburn Abbey. He has taken much pains in investigating the characteristic distinctions of each species; and the botanist will, at once, recognise the careful and accurate manner in which he has pursued the enquiry.”

The frontispiece, which represents the great silver fir in Woburn Park (the dimensions of this fine tree are given in a note, a copy of which was sent us by His Grace in 1837, and the substance of it will be found in the *Arboretum Britannicum*, vol. iv. p. 2332.), the duke informs us, is from “ the correct and delicate pencil of my daughter-in-law, Lady Charles Russell, whose admirable drawings of trees of several species require no praise from me. This tree, with others of the same description, was planted on a hill in Woburn Park, called Stump Cross (the whole covering an area of just one acre of ground), during the minority of Wriothlesley, third Duke of Bedford. The age of this tree must, therefore, be nearly 130 years. The other firs planted at the same time (with the exception of three or four Scotch and silver firs) were taken down in the year 1810, and were then valued at 900*l.*: but I must add that fir timber was at that time at an unusually high price in England, owing to the effects of what Napoleon called his ‘continental system.’

“ I may, perhaps, be allowed to claim a sort of hereditary affection for the pine tribe; as my grandfather, John, Duke of Bedford, who was a great planter, was particularly partial to pines, and other firs.

“ The culture of the family of the *Coniferæ* may be said to be almost in its infancy in this country. The numerous species of pines introduced into Europe from distant climes, from the Himalayan range of mountains and other parts of India, have given a new zest to those who take pleasure in bringing forward and cultivating hitherto unknown productions of the vegetable world. And, without going into an enquiry respecting the commercial advantages to be derived from the knowledge which we are yearly (I may almost say daily) acquiring, of the growth, and values, and properties of trees, I will content myself with observing that the genus *Pinus* is probably entitled to wonder and admiration beyond all others; and that, at no distant period, we may see the *Cedrus Deodara*, the *Abies Douglasii*, and others of similar grandeur, naturalised and flourishing among the cedars of Lebanon in our British forests.

“ Should the perusal of this catalogue stimulate any of the landowners of Great Britain to increase their zeal and their efforts in cultivating this truly valuable family of trees, my object will be fully attained. B.”

Next follows a preface, by Mr. Forbes, His Grace’s gardener, so honourably mentioned by the duke in the preceding quotation. Mr. Forbes, after noticing the various additions that have been made to the genus *Pinus* by the discoveries of Douglas, and the stimulus thereby given to the formation of pinetums throughout the kingdom, expresses his surprise that the pine and fir tribe are not more generally cultivated, so few trees equalling them both in point of utility and ornament. “ The species best calculated for cultivation in

this country," he says "are the *Abies Douglasii*, *nobilis*, *cephalonica*, *Menziesii*, *Smithiana*, and *Pinus excelsa*, *monticola*, *Lambertiana*, *Coulterii*, *Sabianiana*, *ponderosa*. The *Cedrus Deodara* and *Araucaria imbricata* are evidently quite hardy, and capable of standing our frosts without protection." The *Abies Webbiana*, though it has been injured in various places, yet has stood out at Woburn Abbey during the last winter, unprotected, and not the least injured. After noticing the pinetum at Dropmore and that at Woburn Abbey, Mr. Lambert's *Genus Pinus*, the *Memoir on the Coniferæ* of M. Richard, and our *Arboretum Britannicum*, he makes the following observation, with which it is needless to say we entirely agree:—

"Surely, the *Piceæ*, or silver fir tribe, with their linear flat leaves, and erect-growing cones with deciduous scales, are sufficiently distinct to be separated from the spruces, where they are now denominated *Abies*, and united to that genus; although the cones of spruces are always pendent, and the scales persistent, and not deciduous, as they are in the *Piceæ* tribe: the leaves of the *Abies* are likewise more densely placed on the branches, generally needle-shaped, and angular, and very different, both in form and mode of growth, from the silver fir section." (*Pref.*, p. xiv.)

"The pinetum at Woburn Abbey is formed in the pleasure-ground, and no species or variety is described in this catalogue of which there are not plants there; and there are, besides, several plants which have been received under various other names, but from their small size and close proximity they have been omitted, until they have grown of such a size as to admit of ascertaining whether or not they are new and distinct, or mere varieties of well known species."

"In the Woburn evergreen plantation, formed in 1743, and which consists principally of the *Coniferæ* tribe, many beautiful feathered specimens, with majestic stems, may be seen; they may be pronounced as unequalled by any other plantation in the kingdom; particularly the *Pinus Pinaster*, *Strobus*, *sylvestris*, *rigida*, *Cembra*, *Abies*, *pectinata*; and the *Cedrus Libani*; which may be chiefly attributed to the judicious thinning applied to that plantation when in a young state. The soil and site are particularly favourable for the pine tribe, as they delight in a dry sandy loam, where their roots can penetrate freely: this circumstance has induced His Grace the Duke of Bedford to form a second pinetum, under Mr. Ireland, his forest planter, adjoining the evergreens, consisting of a similar soil, more congenial to their growth than that of the pinetum in the pleasure-ground; where it, however, forms an interesting feature in connexion with the *Arboretum*." (*Pref.*, p. xv.)

In the introduction His Grace has kindly noticed the *Arboretum Britannicum*, as a valuable and interesting work; but we must quote the passage, as well to evince our gratitude, as for the sake of the very interesting note which the duke has subjoined to it.

"Anxious to communicate to Mr. Loudon, for his valuable and interesting work, the *Arboretum Britannicum*, all the information in my power respecting the various trees in Woburn Park, I related to him an anecdote of my grandfather, respecting the thinning of the Evergreens plantation; which, as characteristic of the planter, may be here repeated."

"In the year 1743, my grandfather planted the large plantation in Woburn Park, known by the name of the 'Evergreens,' to commemorate the birth of his daughter, afterwards, Caroline, Duchess of Marlborough: it was something more than one hundred acres; and was, before that time, a rabbit warren, producing nothing but a few blades of grass, with the heath or ling indigenous to the soil, and without a single tree upon it.

"In the course of a few years, the duke perceived that the plantation required thinning, in order to admit a free circulation of air, and give health and vigour to the young trees. He accordingly gave instructions to his gardener, and directed him as to the mode and extent of the thinning required. The gardener paused, and hesitated, and at length said, 'Your Grace must pardon me, if I humbly remonstrate against your orders, but I cannot possibly do what you desire; it would at once destroy the young plantation, and, moreover, it would be seriously injurious to my reputation as a planter.'

“My grandfather, who was of an impetuous and decided character, but always just, instantly replied, ‘Do as I desire you, and I will take care of your reputation.’”

“The plantation, which ran for nearly a mile along the road leading from the market-town of Woburn to that of Amptill, was, consequently, thinned according to the instructions of the Duke of Bedford, who caused a board to be fixed in the plantation, facing the road, on which was inscribed, ‘This plantation has been thinned by John, Duke of Bedford, contrary to the advice and opinion of his gardener.’”

The above note appears in the *Arboretum Britannicum*, vol. iv. p. 2183., in which, however, the word road, in the third line above, is inadvertently printed wood, but this is noticed in the errata, p. 2597.

We come next to the catalogue, in which species and varieties are described, and most of them figured, of all of which there are plants in the pinetum at Woburn. Of course, a greater number of species are figured and described in the *Arboretum Britannicum*; because in that work we did not limit ourselves to species of which plants could be procured in the nurseries; nevertheless, in the *Pinetum Woburnense*, there is one coniferous species, *Táxus Harringtonia*, figured, and one or two doubtful species described, which are not in our *Arboretum*. The particulars of these will be found in the following review, which, besides giving a definite idea of the contents of a book which cannot be purchased, may be useful, as showing the number of living species and varieties of *Coníferæ* that may be collected together in the short space of two or three years.

#### PINETUM WOBURNENSE.

*Binàtæ. Leaves in pairs.*

*Pinus pumilio*, Pin. Wob. pl. 1., Arb. Brit. p. 2186., and Hort. Lig. p. 118.

*Pinus pumilio*  $\gamma$  *Fishèrii*, Pin. Wob. p. 3., Arb. Brit. 2187., and Hort. Lig. p. 118. Mr. Forbes agrees with us in thinking this only a variety of *P. pumilio*, with somewhat longer leaves.

*Pinus Mùghus*, Pin. Wob. pl. 2., Arb. Brit. 2187., Hort. Lig. p. 118. Mr. Forbes considers this the species denominated *P. uncinàta* by Capt. S. E. Cook, in which we think he is right.

*Pinus sylvéstris*, Pin. Wob. p. 7., Arb. Brit. p. 2153., Hort. Lig. p. 117. In the Woburn nurseries are a quantity of plants of this species, raised from seed imported from the north of Sweden.

*Pinus sylvéstris*  $\gamma$  *caramínica*, Pin. Wob. p. 9. “Several plants of this pine were reared here a few years ago, under the name of *P. caramínica*, which have since been cultivated, side by side, with similar-sized plants of the *P. sylvéstris*; but I have been unable to discover any distinguishing characters betwixt the two, either in the form, colour, or size of the leaves, or disposition of the branches; their terminal buds are, likewise, identical. I therefore consider this as merely a variety of the *P. sylvéstris*, and it is inserted here as the *Caraminian* variety, until an opportunity occurs of examining its cones, which may, perhaps, warrant its removal from this species; but from what may be judged by the present appearance of the plants, I entertain very slight hopes of its proving any thing else than our Scotch fir. The Scotch, or wild, pine, like all other plants extensively distributed by nature, differs much in different situations and climates; and it would be easy to select numerous varieties from native woods in different parts of Europe, as well as from the seed beds of the nurseries.” We are glad to see Mr. Forbes rising superior to that slavish fear which has hitherto too frequently prevented gardeners from exercising their unbiassed judgement in the matter of specific distinctions. Whatever admits of much doubt cannot be specifically distinct. Every species has a natural characteristic which leaves no doubt as to whether it is a species or a variety. There is no such thing in nature as one species agreeing with another in every particular, except in one point; the fruit, for example. Such differences can only constitute varieties.

*Pinus Escarèna*, Pin. Wob. p. 11., Arb. Brit. 2214., Hort. Lig. p. 119.



This is another variety of Scotch pine; a variety it may be called, differing scarcely, if at all, from the species. How the specific name *Escarèna* came to be applied to a variety of *Pináster* in the Hort. Soc. Garden, and in the *Pinetum Dropmoriense*, we have explained in this Magazine at p. 129.

M. Risso describes the *Escarèna* pine as having a stem long, straight, thin, destitute of branches at the base, and furnished towards the summit with a large horizontal cap, which resembles that of the *meleza* (larch). This and the other details of description appear to us to apply to a particular tree growing in a particular situation, rather than to the species; because no one would think of describing the larch as characterised by a large horizontal cap, though undoubtedly larches may be found with this appearance, both in their native habitats on the Alps, and in our artificial plantations in Britain. This *Escarèna* pine is farther distinguished, M. Risso says, by its erectness and height, standing often like a pollard in a wood of other trees of its congeners. By pollard is evidently here meant, not what is called a pollard in England, but a tall tree with a naked stem, crowned with a few branches at top, such as in Evelyn's time was called a *dottard*. It is said to exude small tears of a kind of whitish concrete manna, which is employed as a purge for children. "The wood of this pine is preferred to all others of the tribe by the carpenter," and the cones are without resin, and but little combustible. M. Risso forwarded specimens of the *P. Escarèna* to Woburn, which appeared to Mr. Forbes identical with *P. sylvéstris*. The Earl of Aberdeen, in a letter to the Duke of Bedford, says: "When I brought the seeds from Nice, I gave them to my gardener, together with the seeds of *P. marítima*, *P. Pinea*, and one or two others. The plant which I gave to Lord Grenville, and those which I have here, under the name of *P. Escarèna*, I have no doubt were erroneously so called by my gardener, who mistook one parcel of seed for the other, and that the plant in question is either the *P. marítima* or *P. Larício*; in fact, a variety of *Pinus Pináster*. The real *P. Escarèna*, I well remember, very much resembled the *Pinus sylvéstris*, although I think there was a marked difference; but, as I have not any description at hand, I cannot now specify it. The tree is not to be seen near Nice, but I found it in considerable numbers at a place called Torretto, about ten or twelve miles from Nice, or more, in the direction of the valley of St. André."

The variety of *P. Pináster* which the Earl of Aberdeen brought to England being a very handsome and very distinct variety, we have named it in p. 128. *P. Pináster Aberdoniæ*.

*Pinus Banksiána*, Pin. Wob. pl. 3., Arb. Brit. p. 2190., Hort. Lig. p. 118.

*Pinus inops*, Pin. Wob. pl. 4., Arb. Brit. p. 2192., Hort. Lig. p. 118.

*Pinus pungens*, Pin. Wob. pl. 5., Arb. Brit. p. 2197., Hort. Lig. p. 118.

*Pinus resinósa*, Pin. Wob. p. 6., Arb. Brit. p. 2210., Hort. Lig. p. 119.

*Pinus Pallasiána*, Pin. Wob. pl. 7., Arb. Brit. p. 2206., Hort. Lig. p. 119.

A considerable number of this pine were planted out on a sandy piece of ground in Woburn Park, where they have now formed handsome trees.

*Pinus Larício*, Pin. Wob. p. 23., Arb. Brit. p. 2204., Hort. Lig. p. 118.

*Pinus halepénsis*, Pin. Wob. pl. 8., Arb. Brit. p. 2231., Hort. Lig. p. 119.

This is the first species which Mr. Forbes identifies with the same species in our *Arboretum Britannicum*, from which we conclude that the *Pinetum Woburnense* had been printed thus far before the numbers of the *Arboretum* which contain the pines had appeared.

*Pinus brútiá*, Pin. Wob. pl. 9., Arb. Brit. p. 2234., Hort. Lig. p. 119. The Earl of Mountnorris, Mr. Forbes observes, was the first person in England that raised this pine from seeds. Sprengel has referred it to *P. Pináster*, not even allowing it the rank of a variety.

*Pinus Pináster*, Pin. Wob. p. 29., Arb. Brit. p. 2213., Hort. Lig. p. 119.

*Pinus Pináster variegáta*, Pin. Wob. p. 30., Arb. Brit. p. 2217., Hort. Lig. p. 119.

*Pinus Pinea*, Pin. Wob. pl. 106. Arb. Brit. p. 2224., Hort. Lig. p. 119. The prophet Hosea (xiv. 8.) says, "I am like a green fir tree: from me is thy fruit found." This, says Mr. Forbes, alludes to the *P. Pinea*, or stone

pine, which, in the East, attains a great height, affords a vast shade, and produces an edible fruit, sweet as almonds. "The *P. Pinea* appears to have been a favourite tree with Don John de Castro, the conqueror of Portuguese India. His Grace the Duke of Bedford informs me that the gigantic pines in the gardens of the Penha Verde, at Cintra, were all planted by Don John himself, and even with his own hand. He was born about the year 1500, bore an eccentric character, and would not allow any fruit trees to be planted in the same garden with his favourite pines. These trees have now attained a great height, and produce numerous cones with perfect seeds. A few years since, while His Excellency Lord G. W. Russell was residing as British minister at Lisbon, His Lordship's children collected a large quantity of seeds from the pine trees at Cintra, and forwarded them to Woburn, where several hundred plants were raised from them, which have now attained the height of betwixt two and three feet, and are dispersed throughout the different plantations. It is, however, singular, that only one tree of the *Pinea* is to be met with of any size in any of the plantations in the vicinity of Woburn, and that specimen is not above twelve feet high."

Notices have been sent us of various trees named *Pinus Pinea*; but, on examining the specimens, or the trees themselves, we have generally found them to be only *P. Pinaster*. We believe there are very few trees above 12 or 15 feet high of this species in England. In Italy the stone pine does not appear to be indigenous, being only found in the neighbourhood of houses, and never, we believe, in masses on the Apennines, or anywhere of a large size. It is considered more as a fruit tree than a timber tree, and as such might be planted in the form of an orchard in England, where, as at Woburn and Dropmore, it would ripen cones with very good kernels.

*Pinus japonica*, Pin. Wob. p. 33. "This pine was raised by Mr. Murray of the Glasgow Botanic Gardens, from seeds that he received from Japan. It is the only species of pine that has yet been introduced from that country to Britain; but whether it will ultimately prove a distinct species from those hitherto cultivated in our collections, cannot yet be determined, as the plant in this collection is not above 18 inches high, consequently it has not assumed its natural character nor produced cones." (p. 33.)

*Pinus nepalensis*, Pin. Wob. p. 34. Leaves in pairs, occasionally in threes, from eight to ten inches long, cylindrical on the exterior surface, and slightly concave on the interior, smooth, slender, and of a dark green colour. Sheaths short, torn at the apex.

This plant was received from Mr. Lawson, of Edinburgh, who considered it a distinct species. It certainly appears very different from any of the species that I am acquainted with, frequently producing binate, ternate, and quarter-nate leaves on the same shoot, from eight to ten inches long, rounded on the exterior surface, and concave on the inner; the margins are finely serrated; the young leaves of a glaucous hue, becoming of a bright green colour when at maturity. This pine is very tender, and requires to be well protected during the winter months. It is a native of Nepal. (p. 34.)

*Ternatæ. Leaves generally in threes.*

*Pinus variabilis*, Pin. Wob. pl. 11., Arb. Brit. 2195., and Hort. Lig. p. 118., as *P. mitis*.

*Pinus mitis*, Pin. Wob. p. 37., Arb. Brit. 2195., Hort. Lig. p. 118. Lambert's *P. variabilis* has always appeared to us a very doubtful species; perhaps only a variety of *P. Tæda*.

*Pinus sinensis*, Pin. Wob. pl. 12., Arb. Brit. p. 2264., Hort. Lig. p. 120. The fine tree of this species at Redleaf, unquestionably the largest in England (see *Arb. Brit.*), was killed to the ground in the winter of 1837-8.

*Pinus rigida*, Pin. Wob. pl. 12., Arb. Brit. p. 2239., Hort. Lig. p. 119.

*Pinus Tæda*, Pin. Wob. pl. 14., Arb. Brit. p. 2237., Hort. Lig. p. 119.

*Pinus ponderosa*, Pin. Wob. pl. 15., Arb. Brit. p. 2244., Hort. Lig. p. 120. The plant at Woburn was, in 1838, twelve feet high.

*Pinus scariòsa*, Pin. Wob. p. 46., Arb. Brit. p. 2158., Hort. Lig. p. 118.

*Pinus serótina*, Pin. Wob. pl. 16., Arb. Brit. p. 2242., Hort. Lig. p. 120.

*Pinus Llaveàna*, Pin. Wob. pl. 17., Arb. Brit. p. 2267., Hort. Lig. p. 120.

M. Otto of Berlin inadvertently sent us a cone, which he considered as that of this species, but which M. Schlechtendahl detected to be erroneous. M. Otto afterwards sent us the true cone of *P. Llaveàna*, which we have figured and described in p. 128.

*Pinus insignis*, Pin. Wob. pl. 18., Arb. Brit. p. 2265., Hort. Lig. p. 120.

Plants of this species were killed almost everywhere in Britain in the winter 1837-8, but one survives in the pleasure-ground of R. Mangles, Esq., Sunning Hill. The situation is dry and elevated, and the plant received no protection whatever.

*Pinus Gerardiàna*, Pin. Wob. pl. 19., Arb. Brit. p. 2254., Hort. Lig. p. 120.

*Pinus longifolia*, Pin. Wob. pl. 20., Arb. Brit. p. 2252., Hort. Lig. p. 120.

*Pinus canariénsis*, Pin. Wob. pl. 21., Arb. Brit. p. 2261., Hort. Lig. p. 120.

*Pinus palústris*, Pin. Wob. pl. 22., Arb. Brit. p. 2156., Hort. Lig. p. 120.

*Pinus palústris*  $\gamma$  *excélsa*, Pin. Wob. p. 62., Arb. Brit. p. 2256., Hort. Lig. p. 120.

*Pinus Sabiniàna*, Pin. Wob., pl. 23., Arb. Brit. p. 2246., Hort. Lig. p. 120.

*Pinus Couílteri*, Pin. Wob. pl. 25. and 26., Arb. Brit. p. 2250., Hort. Lig. p. 120.

*Quinàta.* Leaves generally five in a sheath.

*Pinus Cémbra*, Pin. Wob. pl. 27., Arb. Brit. p. 2274., Hort. Lig. p. 121. The specimen of this tree in the Woburn evergreen plantation is 30 ft. high, and the most beautiful which Mr. Forbes has ever seen.

*Pinus Cémbra*  $\gamma$  *helvética*, Pin. Wob. p. 71., Arb. Brit. p. 2275., Hort. Lig. p. 121. Mr. Forbes received specimens from two handsome trees growing at Peterhoff, near St. Petersburg; and from trees about thirty years old, and 35 ft. high, from the estate of Balharry, Forfarshire, the property of John Smith, Esq.

*Pinus Cémbra sibírica*, Pin. Wob. p. 73., Arb. Brit. p. 2275., Hort. Lig. p. 121. A plant of this species, 2 ft. in height, and forming a dense bush in the botanic gardens at Antwerp, is there named *Pinus monstròsa*.

*Pinus leiophýlla*, Pin. Wob. pl. 28., Arb. Brit. p. 2273., Hort. Lig. p. 121.

*Pinus excélsa*, Pin. Wob. pl. 29., Arb. Brit. p. 2285., Hort. Lig. p. 121. A specimen of this tree, raised from seed in the Perth Nursery, is nearly 20 ft. in height, and quite hardy.

*Pinus Lambertiana*, Pin. Wob. pl. 30., Arb. Brit. p. 2288., Hort. Lig. p. 121. The specimen of this tree in the pinetum at Woburn was growing vigorously, and was pronounced by the late Mr. Sabine to be the finest he had ever seen; but, a few weeks after he saw it, two very hot days occurred, which immediately destroyed it. Mr. Forbes is therefore inclined to think that it will succeed best in a northern aspect.

*Pinus monticola*, Pin. Wob. pl. 31., Arb. Brit. p. 2291., Hort. Lig. p. 121.

*Pinus Stròbus*, Pin. Wob. p. 83., Arb. Brit. p. 2280., Hort. Lig. 121. "The original tree, first introduced to England by Viscount Weymouth, ancestor of the present Marquess of Bath, is now standing, though perfectly decayed, in a timber grove at Longleat, Wiltshire. This pine appears to luxuriate best in a sandy soil, well sheltered from the high westerly winds."

*Solítària angulata.* Leaves solitary, angular.

*Abies excélsa*, Pin. Wob. p. 87., Arb. Brit. p. 2293., Hort. Lig. p. 121.

*Abies excélsa* and *carpáthica*, Pin. Wob. p. 90., Arb. Brit. p. 2294., Hort. Lig. p. 121.

*Abies excélsa*  $\beta$  *élegans*, Pin. Wob. p. 90., Arb. Brit. p. 2295., Hort. Lig. p. 121.

*Abies excélsa*  $\gamma$  *miniàta*, Pin. Wob. p. 91., Arb. Brit. p. 2295., Hort. Lig. p. 122. A minute-growing variety, producing erect slender branches. Long

cultivated in the collection of Messrs. Dickson of Chester, where it does not grow half the size of *A. Clanbrasiliana*.

*A'bies excélsa*  $\delta$  *variegàta*, Pin. Wob. p. 91., Arb. Brit. p. 2294., Hort. Lig. p. 121.

*A'bies excélsa*  $\epsilon$  *Clanbrasiliana*, Pin. Wob. p. 92., Arb. Brit. p. 2294., Hort. Lig. p. 121.

*A'bies Menzicssii*, Pin. Wob. pl. 32., Arb. Brit. p. 2321., Hort. Lig. p. 122.

*A'bies álba*, Pin. Wob. pl. 33., Arb. Brit. p. 2310., Hort. Lig. p. 122.

*A'bies nígra*, Pin. Wob. pl. 34., Arb. Brit. p. 2312., Hort. Lig. p. 122.

*A'bies cærúlea*, Pin. Wob. p. 99., Arb. Brit. p. 2316., Hort. Lig. p. 122.

*A'bies rùbra*, Pin. Wob. pl. 35., Arb. Brit. p. 2316., Hort. Lig. p. 122. This tree, in the arboretum of Thomas Brookes, Esq., of Flitwick House, has attained the height of 17 ft., and appears very distinct.

*A'bies Smithiana*, Pin. Wob. pl. 36., Arb. Brit. p. 2317., Hort. Lig. p. 122.

*Solitària compréssa. Leaves solitary and flat.*

*A'bies pectinàta*, Pin. Wob. p. 105., Arb. Brit. p. 2329., Hort. Lig. p. 112. The most ornamental trees of this fir, which Mr. Forbes has seen, are at Blair Adam in Kinrosshire. They are beautifully feathered from the base to the summit, with long branches, horizontal at the ground, but aspiring towards the apex.

*A'bies pectinàta*  $\beta$  *variegàta*, Pin. Wob. p. 107., Arb. Brit. p. 2330., Hort. Lig. p. 122.

*A'bies balsàmea*, Pin. Wob. pl. 37., Arb. Brit. p. 2339., Hort. Lig. p. 123.

*A'bies balsàmea*  $\gamma$  *longifòlia*, Pin. Wob. p. 110., Arb. Brit. p. 2339., Hort. Lig. p. 123.

*A'bies Fràseri*, Pin. Wob. pl. 38., Arb. Brit. p. 2340., Hort. Lig. p. 123.

*A'bies Pichta*, Pin. Wob. pl. 39., Arb. Brit. p. 2338., Hort. Lig. p. 123.

*A'bies nóbilis*, Pin. Wob. pl. 40., Arb. Brit. p. 2342., Hort. Lig. p. 123. Douglas says he spent three weeks in a forest composed of this tree; and day by day could not cease to admire it.

*A'bies Webbiàna*, Pin. Wob. pl. 41., Arb. Brit. p. 2344., Hort. Lig. p. 123. This purple-coned fir, Dr. Wallich says, is called Oumar in the Himalayas. We have spelt the word Oonum, on the authority of Dr. Royle. The plant of this species in the pinetum at Dropmore, Mr. Frost, the intelligent and indefatigable gardener there, informs us, is this day (April 12. 1839) more vigorous than ever. It had been planted in poor gravel; but last year he removed the gravel all round the plant, and replaced it by a compost of sand, loam, and rotten leaves; scraping off from the shoots the lichens which had begun to cover them, in consequence of the slow growth and want of vigour of the plant.

*A'bies cephalònica*, Pin. Wob. pl. 42., Arb. Brit. p. 2325., Hort. Lig. p. 122., and Gard. Mag. p. 130. and p. 238.

*A'bies grándis*, Pin. Wob. pl. 43., Arb. Brit. p. 2341., Hort. Lig. p. 123.

*A'bies amábilis*, Pin. Wob. pl. 44., Arb. Brit. p. 2342., Hort. Lig. p. 123.

*A'bies Douglàsii*, Pin. Wob. pl. 45., Arb. Brit. p. 2319., Hort. Lig. p. 122.

*A'bies canadénsis*, Pin. Wob. p. 129., Arb. Brit. p. 2322., Hort. Lig. p. 122.

*Fasciculata decidua. Leaves in clusters and deciduous.*

*Làrix europæ'a*, Pin. Wob. p. 133., Arb. Brit. p. 2350., Hort. Lig. p. 123.

*Làrix europæ'a*  $\gamma$  *péndula*, Pin. Wob. p. 136., Arb. Brit. p. 2350., Hort. Lig. p. 123.

*Làrix péndula*, Pin. Wob. pl. 46., Arb. Brit. p. 2400., Hort. Lig. p. 124.

*Làrix microcárpa*, Pin. Wob. pl. 49. (47)., Arb. Brit. p. 2400., Hort. Lig. p. 124.

*Làrix intermèdia*, Pin. Wob. p. 141., Arb. Brit. p. 2350., Hort. Lig. p. 124.

*Làrix sibírica*, Pin. Wob. p. 141., Arb. Brit. p. 2350., Hort. Lig. p. 123.

*Fasciculata persistentia. Leaves in clusters and persistent.*

*Cèdrus Libàni*, Pin. Wob. p. 145., Arb. Brit. p. 2402., Hort. Lig. p. 124.

Several trees were planted in the Woburn evergreen plantation in 1743, which have now formed very magnificent specimens; one is 84 ft. high, with a trunk 14 ft. 3 in. in circumference at 3 ft. from the ground. Several are above 80 ft. high, with branches extending 50 ft. on each side of the trunk. We may observe here, that an interesting account of this evergreen plantation will be found in Mr. Repton's works. See our octavo edition.

*Cèdrus Deodàra*, Pin. Wob. pl. 48. and 49., Arb. Brit. p. 2428., Hort. Lig. p. 124. The specimen of this tree in the pinetum at Woburn was 9 ft. high in 1838.

*Araucària excelsa*, Pin. Wob. pl. 50. and 51., Arb. Brit. p. 2440., Hort. Lig. p. 124.

*Araucària Cunninghàmi*, Pin. Wob. pl. 52., Arb. Brit. p. 2443., Hort. Lig. p. 124. The finest specimen which Mr. Forbes has seen was in the Jardin des Plantes, where, in 1835, it was 10 ft. high, clothed with branches from the base to the summit.

*Araucària brasiliàna*, Pin. Wob. pl. 53. and 54., Arb. Brit. p. 2439., Hort. Lig. p. 124.

*Araucària imbricàta*, Pin. Wob. pl. 55. and 56., Arb. Brit. p. 2432., Hort. Lig. p. 124. The plant at Woburn was raised from seeds brought from South America, by Lord Edward Russell, in the spring of 1838.

*Cunninghàmia sinènsis*, Pin. Wob. pl. 57., Arb. Brit. p. 2445., Hort. Lig. p. 124. The plant at Woburn, during the severity of the frost in 1337-8, was only protected with a few laurel branches placed around it, by which it was effectually preserved.

*Dámbara orientàlis*, Pin. Wob. pl. 58., Arb. Brit. p. 2447., Hort. Lig. p. 124.

*Dámbara austràlis*, Pin. Wob. pl. 59., Arb. Brit. p. 2448., Hort. Lig. p. 124. The finest specimen which Mr. Forbes has seen is one in the conservatory of His Grace the Duke of Devonshire, at Chiswick.

*Taxòdium distichum*, Pin. Wob. pl. 60., Arb. Brit. p. 2481., Hort. Lig. p. 126.

*Taxòdium sinèse*, Pin. Wob. p. 179., Arb. Brit. p. 2481., Hort. Lig. p. 126.

*Taxòdium sinèse γ péndulum*, Pin. Wob. p. 180., Arb. Brit. p. 2481., Hort. Lig. p. 126. A fine specimen exists in Mr. Knight's nursery, Chelsea.

*Cuprèssus sempervirens*, Pin. Wob. p. 181., Arb. Brit. p. 2464., Hort. Lig. p. 125. The doors of St. Peter's Church at Rome were made from the wood of this tree, which are said to have lasted 1,100 years. It was also much used by the Egyptians, for the manufacture of their mummy cases.

*Cuprèssus sempervirens γ stricta*, Pin. Wob. p. 183., Arb. Brit. p. 2465., Hort. Lig. p. 125.

*Cuprèssus thyòides*, Pin. Wob. p. 183., Arb. Brit. p. 2475., Hort. Lig. p. 125.

*Cuprèssus horizontàlis*, Pin. Wob. pl. 61., Arb. Brit. p. 2465., Hort. Lig. p. 125. The Duke of Bedford saw a tree of great magnitude, of this species, in the Botanic Garden at Montpellier, last summer, which is said to be 700 years old. There is a specimen at White Knights, and another in Dr. Penrose's garden, at Little Brit Hill, Bucks, which is 20 ft. high. Both specimens bear numerous cones. Mr. Forbes considers this a different tree from any of the varieties of *C. sempervirens* that he is acquainted with. He says, it is readily distinguished from them by its horizontal branches, and light-coloured minute leaves.

*Cuprèssus fastigiàta*, Pin. Wob. p. 186. Leaves ternate, glaucous, keel-shaped, somewhat subulate, decurrent at the base, obtuse at the apex. Branchlets quadrifarious, erect, rounded, of a dark brown colour.

"In habit of growth, this plant much resembles the *Cuprèssus sempervirens*, but it is readily distinguished from that species by its very blue glaucous leaves, which are also more rounded and keel-shaped, as well as more distant and spreading on the old wood; they are longer, and somewhat awl-shaped, with obtuse apices, and totally different from those of the above-mentioned species. It was received here from Mr. Knight, of the King's Road, Chelsea, under the name of *Juniperus fastigiàta*; but its mode of growth, and other characters, appear to me to be that of the cypress, and not the juniper."

*Cuprèssus lusitànica*, Pin. Wob. pl. 62., Arb. Brit. p. 2477., Hort. Lig. p. 125.

*Cuprèssus Tournefortii*, Pin. Wob. p. 188., Arb. Brit. p. 2480., Hort. Lig. p. 125.

*Cuprèssus glauca*, Pin. Wob. p. 189., Arb. Brit. p. 2477., Hort. Lig. p. 125. Raised at Woburn from seeds sent by Dr. Lippold from Madeira [and in all probability nothing more than *C. lusitànica*, of which *C. glauca* is a well-known synonyme].

*Cuprèssus torulosa*, Pin. Wob. p. 189., Arb. Brit. p. 2478., Hort. Lig. p. 125.

*Cuprèssus Coulteri*, Pin. Wob. p. 190. Discovered in Mexico by Dr. Coulter; "and the plant now in the collection at Woburn Abbey was raised from seeds by Mr. Niven of the Glasnevin Botanic Garden, Dublin, which he procured from the specimens in Dr. Coulter's herbarium, and which had been fifteen years gathered previously to sowing. Mr. Forbes has not yet exposed this species to the open air.

*Cuprèssus Fothergilli*, Pin. Wob. p. 191., Arb. Brit. p. 2480., Hort. Lig. p. 125.

*Cuprèssus articulata*, Pin. Wob. p. 191. In all probability *Thuja articulata*, *Cállitris quadrivalvis*, Arb. Brit. p. 2462.

*Thuja occidentàlis*, Pin. Wob. p. 193., Arb. Brit. p. 2454., Hort. Lig. p. 125. The branches, when bruised and mixed with hog's lard, are said to cure the rheumatism.

*Thuja plicata*, Pin. Wob. p. 195., Arb. Brit. p. 2458., Hort. Lig. p. 125. Discovered by Mr. Menzies, and introduced by him in 1796.

*Thuja orientàlis*, Pin. Wob. p. 196., Arb. Brit. p. 2459., Hort. Lig. p. 125.

*Thuja pèndula*, Pin. Wob. pl. 63., Arb. Brit. p. 2461., Hort. Lig. p. 125.

*Thuja orientàlis*  $\gamma$  *tatàrica*, Pin. Wob. p. 197., Arb. Brit. p. 2459., Hort. Lig. p. 125.

*Juniperus virginiana*, Pin. Wob. p. 199., Arb. Brit. p. 2495., Hort. Lig. p. 126.

*Juniperus lycia*, Pin. Wob. p. 200., Arb. Brit. p. 2502., Hort. Lig. p. 127.

*Juniperus phænicea*, Pin. Wob. p. 201., Arb. Brit. p. 2501., Hort. Lig. p. 127.

*Juniperus Oxycèdrus*, Pin. Wob. p. 201., Arb. Brit. p. 2494., Hort. Lig. p. 126.

*Juniperus commùnis*, Pin. Wob. p. 202., Arb. Brit. p. 2489., Hort. Lig. p. 126.

*Juniperus commùnis*  $\beta$  *nàna*, Pin. Wob. p. 203., Arb. Brit. p. 2489., Hort. Lig. p. 126.

*Juniperus suècica*, Pin. Wob. p. 203., Arb. Brit. p. 2489., Hort. Lig. p. 126.

*Juniperus cracòvia*, Pin. Wob. p. 204. The plant to which this name is attached in the arboretum of Messrs. Loddiges appeared to us identical with the common juniper.

*Juniperus prostrata*, Pin. Wob. p. 204., Arb. Brit. p. 2360., Hort. Lig. p. 127.

*Juniperus canadensis*, Pin. Wob. 204., Arb. Brit. p. 2489., Hort. Lig. p. 126.

*Juniperus excelsa*, Pin. Wob. pl. 64., Arb. Brit. p. 2503., Hort. Lig. p. 127.

*Juniperus bermudiàna*, Pin. Wob. p. 205., Arb. Brit. p. 2498., Hort. Lig. p. 126.

*Juniperus Sabina*, Pin. Wob. p. 206., Arb. Brit. p. 2499., Hort. Lig. p. 126. There are several plants of this species at Woburn, 12 ft. high, and forming densely clothed pyramids.

*Juniperus Sabina a alpina*, Pin. Wob. p. 206., Arb. Brit. p. 2499., Hort. Lig. p. 127.

*Juniperus Sabina*  $\beta$  *tamariscifolia*, Pin. Wob. p. 207., Arb. Brit. p. 2499., Hort. Lig. p. 127.

*Juniperus Sabina*  $\gamma$  *cupressifolia*, Pin. Wob. p. 207., Arb. Brit. p. 2499., Hort. Lig. p. 126.

*Juniperus oblónga*, Pin. Wob. p. 207., Arb. Brit. p. 2489., Hort. Lig. p. 126.

*Juniperus sibíríca*, Pin. Wob. p. 207., Arb. Brit. p. 2489., Hort. Lig. p. 126.

*Juniperus chinénsis*, Pin. Wob. pl. 65., Arb. Brit. p. 2505., Hort. Lig. p. 127.

*Juniperus Hudsoniána*, Pin. Wob. p. 208., Arb. Brit. p. 2499., Hort. Lig.

p. 127.

*Juniperus dáuríca*, Pin. Wob. p. 209., Arb. Brit. p. 2489., Hort. Lig. p. 126.

Gmelin observes, in his *History of the Plants of Siberia*, that the Cossacks burn the twigs of this plant to fumigate those that are afflicted with obscure diseases, or those which they superstitiously suppose to be excited by devils, of whose agency they are extremely credulous, and whom they believe to be pacified with smoke and hideous noises, as being congenial to their own nature.

*Juniperus recurva*, Pin. Wob. p. 209., Arb. Brit. p. 2504., Hort. Lig. p. 127.

*Podocárpus nerüfólius*, Pin. Wob. p. 211., Arb. Brit. p. 2100., Hort. Lig.

p. 117.

*Podocárpus elongátus*, Pin. Wob. p. 211., Arb. Brit. p. 2100., Hort. Lig.

p. 117.

*Podocárpus chinénsis*, Pin. Wob. p. 212., Arb. Brit. p. 2100., Hort. Lig.

p. 117.

*Podocárpus latifólius*, Pin. Wob. p. 220., Arb. Brit. p. 2100., Hort. Lig.

p. 117.

*Táxus baccáta*, Pin. Wob. p. 213., Arb. Brit. p. 2066., Hort. Lig. p. 117.

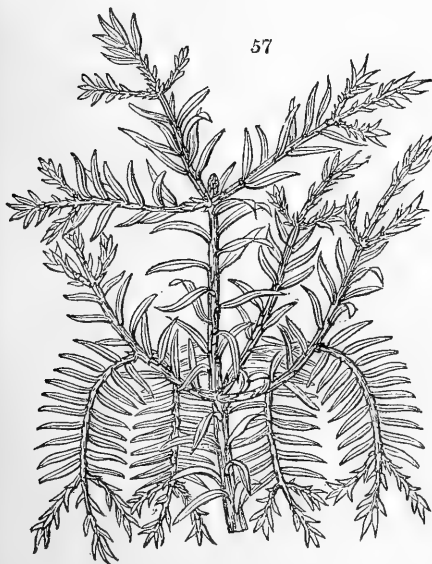
The Duke of Bedford has, in his library at Woburn Abbey, a table made of a yew tree, which was found in the fens of Cambridgeshire, four years ago, whilst excavating the ground for the Nene outfall, 20 ft. below the surface of the ground, standing in an upright position, and rooted in the soil. Professor Buckland thinks it possible that it may have existed there before the deluge.

*Táxus baccáta*  $\gamma$  *variegáta*, Pin. Wob. p. 214., Arb. Brit. p. 2066., Hort. Lig. p. 117.

*Táxus canadénsis*, Pin. Wob. p. 215., Arb. Brit. p. 2093., Hort. Lig. p. 117.

*Táxus fastigiáta*, Pin. Wob. p. 215., Arb. Brit. p. 2066., Hort. Lig. p. 117.

*Táxus stricta*, Pin. Wob. p. 216., Arb. Brit. p. 2066., Hort. Lig. p. 117.



*Táxus Harringtónia*, Pin. Wob. pl. 68., and our *fig. 57.* reduced from that plate; and *fig. 58.* showing the leaves of the natural size. This we considered to be the *Táxus macrophýlla* of Thunberg, a native of Japan, and noticed as such

in our Arb. Brit. p. 2190., and in Hort. Lig. p. 117. Whether it is distinct or not, it is a very handsome species, well deserving of cultivation, and it appears to be tolerably hardy. It was introduced in 1837, by Mr. Knight of the Exotic Nursery, King's Road, Chelsea, and named by him "in compliment to the Earl of Harrington, who is devotedly attached to this tribe of plants, and who has formed extensive avenues, and various objects, with the yew, at Elvaston Castle." The following specific character and descriptive particulars are given by Mr. Forbes:—

"Leaves distich-flat, from 1 in. to 1½ in. in length, dark green and shining on the upper surface, of a white glaucous hue beneath, with the exception of the midrib and revolute margins, which are of a bright green colour. The apex mucronate, footstalks short, branches round and furrowed.

"The *T. Harringtonia* is readily distinguished from all the well authenticated species by its longer revolute leaves, which are of a silvery glaucous colour on the under side; the edges are bright green, as well as the midrib, which is very prominent on the upper surface. The branches are rounded, and striated, forming a somewhat pendulous habit of growth."

*Tárus nucífera*, Pin. Wob. p. 218., Arb. Brit. p. 2100., Hort. Lig. p. 117. There is a good plant of this very rare species in the ample collection of W. Harrison, Esq., at Cheshunt, Herts.

*Tárus Makóya*, Pin. Wob. p. 218. Leaves linear, acute; edges slightly revolute; dark green, and shining above, pale beneath; midrib prominent. This appears to be a very distinct-growing plant from any of the species already described, producing much narrower leaves, which vary in length from 1 in. to 1½ in., and are terminated by a sharp point. It was discovered in Japan by Dr. Siebold. The species was sent to the Woburn collection by Mr. Low.

*Dacrýdium cuprésinum*, Pin. Wob. pl. 67., Arb. Brit. p. 2100., Hort. Lig. p. 117.

The Duke of Bedford, in an addendum, states that, whilst the *Pinetum Woburnense* was in the press, a severe storm occurred on the morning of January 6. 1839, which destroyed several very fine trees in Woburn Park and plantations; amongst these were a cedar of Lebanon, 83 ft. high, and containing 220 ft. of timber; a silver fir, 100 ft. high, and containing 120 ft. of timber; and a Scotch pine, 86 ft. high, and containing 72 ft. of timber. These trees were planted in 1743.

The chief circumstance in which the *Pinetum Woburnense* and the article on *Abiétinæ* and *Taxæcæ* in the *Arboretum Britannicum* differ, is in the former making species in several cases where we make only varieties. The following comparative list will show the cases to which we refer, and may prove useful to the young gardener:—

PINETUM WOBURNENSE.	ARBORETUM BRITANNICUM.
<i>Abies cærúlea</i>	<i>Abies (nigra) rubra</i> 2 <i>cærúlea</i>
<i>Frasèrii</i>	<i>Picea (balsàmea) Fràseri</i>
<i>Pícta</i>	( <i>pectinàta</i> ) <i>Pícta</i>
<i>rùbra</i>	<i>Abies (nigra) rubra</i>
<i>Cuprésus articulàta</i>	<i>Cállitris quadrívalvis</i>
<i>gláuca</i>	<i>Cuprésus lusitànica</i>
<i>Juníperus canadénsis</i>	<i>Juníperus commúnis</i> 6 <i>canadénsis</i>
<i>Hudsoniàna</i>	<i>Sabìna</i> 4 <i>prostràta</i>
<i>oblónga</i>	<i>commúnis</i> 4 <i>oblónga</i>
<i>prostràta</i>	<i>Sabìna</i> 4 <i>prostràta</i>
<i>suécica</i>	<i>commúnis</i> 2 <i>suécica</i>
<i>sibírica</i>	<i>commúnis</i> 3 <i>nàna</i>
<i>Làrix intermèdia</i>	<i>Làrix europæ'a</i> 10 <i>intermèdia</i>
<i>sibírica</i>	<i>europæ'a</i> 8 <i>sibírica</i>
<i>Pínus Mùghus</i>	<i>Pínus sylvéstris pumílio</i> 4 <i>Mùghus</i>
<i>Pallasiana</i>	( <i>Larício</i> ) <i>Pallasiana</i>



<p><i>Pi.</i> pumflio              Fishèrù              scariòsa              uncinàta  <i>Táxus canadénsis</i>              fastigiàta              stricta  <i>Thùja plicàta</i></p>	<p><i>Pi.</i> (sylvéstris) pumílio              (sylvéstris) pumílio 3 Físcheri              sylvéstris 8 scariòsa              sylvéstris 3 uncinàta  <i>Táxus</i> (baccàta) canadénsis              baccàta 2 fastigiàta              baccàta 4 erécta  <i>Thùja</i> (occidentàlis) plicàta.</p>
--	--

Species and varieties of *Coníferæ* in the *Pinetum Woburnense*, not included in the *Arboretum Britanicum* : —

- Cuprèssus Coultèrù* (a seedling)  
     fastigiàta (doubtful)
- Juníperus cracòvia* (a variety of the common Juniper)
- Pìnus japònica* (a seedling, doubtful)
- Táxus Harringtònia* (very distinct, see the fig. in p. 273.)
- Makóya* (a seedling, doubtful)

The species and varieties of *Taxàcææ* and *Abiétinæ* in the *Arboretum Britanicum* not included in the *Pinetum Woburnense* are numerous; but, as they are chiefly of kinds plants of which cannot be procured in this country, it is nor worth while to give the names; more especially as they may be learned at a very small cost from the *Hortus Lignosus*.

We have now gone through the *Pinetum Woburnense* with the care and attention which were due to such a magnificent contribution to botanical science. The plates have been drawn and engraved by Mr. Weddell; the same artist who was employed by Mr. Lambert to execute the plates for the last two volumes of his *Monograph of the Genus Pinus*. It is therefore almost unnecessary to state that they could not have been better executed by any other artist in this country. They have been also coloured under Mr. Weddell's inspection; so that, for all purposes of reference, they will be of the greatest value to the botanist. The letterpress is not less creditable to Mr. Forbes and the Duke of Bedford than the plates are to Mr. Weddell. The activity of Mr. Forbes in collecting and describing so many species and varieties in so short a period, and, at the same time, managing so extensive a concern as the gardens at Woburn Abbey, is to us altogether astonishing.

ART. IV. *Catalogue of Works on Gardening, Agriculture, Botany, Rural Architecture, &c., lately published, with some Account of those considered the more interesting.*

BRITISH.

*SCHOOL Botany; or, an Explanation of the Characters and Differences of the principal Natural Classes and Orders of Plants belonging to the Flora of Europe, in the Botanical Classification of De Candolle. For the Use of Students preparing for their Matriculation Examination in the University of London. By John Lindley, Ph. D., F.R.S., &c. &c. London, 1839. 8vo, pp. 218, numerous woodcuts.*

We are delighted to see that, "by the regulations of the University of London, it is required of all students, that, two years previously to proceeding to their examination for their first degree, they shall be examined, among other subjects, in 'the characters and differences of the principal natural classes and orders of plants belonging to the flora of Europe, in the botanical classification of De Candolle.'" This "regulation" of the London University will effect wonders for the spread of rational botany; and, as Dr. Lindley expresses it, of making "young men acquainted with the names and properties of the common

objects that surround them." The university has shown great wisdom, in our opinion, in preferring the natural system of De Candolle, and limiting the examination to the flora of Europe; not that De Candolle's system is perfect, but it is better known than any other, and sufficiently perfect for the grand object of all natural systems, that of studying plants in masses.

Dr. Lindley appears to us to have been equally judicious in his selection of plants, having "generally chosen such as are nearly within any man's reach." "A very small sum," the doctor adds, "will enable any schoolmaster to cultivate all the species in a garden, where they may be constantly at hand." Would that we could see a national system of education established, with a workshop for teaching mechanics and chemistry, a kitchen for cookery and women's work, and a garden for vegetable culture, attached to every school-house! We might then hope for something like general improvement and happiness in every grade of society; for a superior degree of intellect, morals, and manners in the lowest grades would not fail to operate powerfully on those above them.

Chap. I. treats Of Plants in General; II. Of the Classes of Plants; III. Of the Subdivisions of Exogens; IV. Of the Thalamifloral Exogens; V. Of Calycifloral Exogens; VI. Of Corollifloral Exogens; VII. Of Monochlamydeous Exogens; VIII. Of Endogens; and IX. Of Cryptogamic Plants, or Acrogens.

This little book may therefore be considered a succinct introduction to botany, by the hand of a master in the science.

*Conversations on Vegetable Physiology; comprehending the Elements of Botany, with their Application to Agriculture.* By Mrs. Marcet. Third edition, 8vo, pp. 449, 4 plates. London, 1839.

A new edition of one of the best works that have ever appeared on the subject of vegetable physiology. In short, as the authoress informs us in the preface, it contains the essence of Professor De Candolle's lectures. This work, and Dr. Lindley's *Ladies' Botany*, ought to be in the library of every family where there are daughters to educate; for who would wish to have a daughter brought up in ignorance of botany and entomology?

*The Floriculturist, comprising Essays on the History, Growth, and Management of Fancy and other Flowers.* By James Pile. Illustrated with coloured Portraits, from some of the finest Specimens. In monthly Numbers, royal 8vo, 2s. each. Numbers I. and II. To be completed in 24 Numbers. London, 1839.

A very commonplace treatise on florist's flowers, with badly coloured plates; and such botanic names as occur badly spelt. As a proof, the following appear in the last 18 lines of p. viii. of Number I.: Astu, for Aster. Humea, for Humea. Iria Lobelia? Chrysanthenun, for Chrysanthemum. Dianthus cariophyllus, for Dianthus Caryophyllus. Malvia, for Malva. Calendrina, for Calandrinia. Ranunculas, for Ranunculus. Album? And a comma between nearly all the generic and specific names: such as, Argemone, speciosa; Salvia, coccinea; Gladiolus, floribundus; Fuchsia, globosa; Collinsia, bicolor; Delphinium, sinensis picta; Gilia, tricolor; and many others.

*A Review of the References to the Hortus Malabaricus of Henry Van Rheede Van Draakenstein.* Not published. By L. W. Dillwyn. 8vo, pp. 69. Swansea.

In his preface, the author observes that the *Hortus Malabaricus* has been so generally cited in all works on botany for nearly a century and a half, that "this review can hardly fail to be of some use, particularly to the students of Oriental botany. Opposite to the number of each plate I have given, so far as I could collect them, the various synonymous names of the species to which the figure belongs; but more particularly those for which it has been quoted;

and the names of the authors, when they have given a direct reference to the plate, are printed in Italics. In a paragraph below, I have noticed those other references which I believe to be erroneous, and have offered a few occasional remarks on the species."

The references occupy sixty-nine pages, and must have cost the author immense care and labour. They can only have been made by a profound botanist, possessing an excellent library, and they will be highly valued by those for whom they are intended. We have noticed a number of references to our *Hortus Britannicus*, which we shall take advantage of in a new edition; and some also to our *Arboretum Britannicum*. The author quotes ninety-two different works, which shows the great extent to which references have been made to the *Hortus Malabaricus*.

*Every Man his own Gardener, being a complete Gardener's Calendar, and General Directory.* By Thomas Mawe and John Abercrombie. Twenty-fourth Edition. By James Main, A.L.S. 8vo, pp. 420. London, 1839.

This long-established and well-known work has been thoroughly revised and greatly improved by Mr. Main, than whom we do not know a better man for such a task. In the introduction a brief but comprehensive view is taken of all that has been done in gardening since the time of Abercrombie, which is well calculated to give the reader full confidence in Mr. Main's knowledge of the subject.

*Practical Hints on the Culture of the Pine-Apple.* By R. Glendinning, gardener to the Right Hon. Lord Rolle, Bicton. 18mo, pp. 55, one folding plate. London, 1839.

The object in writing this essay, Mr. Glendinning informs us, is to improve the mode of cultivating the pine-apple in that part of Devonshire over which the Devon and Exeter Botanical and Horticultural Society has influence; "for, although there may be successful cultivators of this unrivalled fruit in the county, the exhibitions have not evinced a proportionate progress in this, as in other productions. (*Advert.*, p. iv.)

The work is divided into seven chapters. In the first, which is introductory, Mr. Glendinning notices the remarkable and gratifying fact, that, a few years ago, the culture of the pine-apple was confined "to a very few gardens of pre-eminent notoriety, where generally first-rate gardeners were kept;" but that, at present, "almost every place, however limited in means, with, perhaps, only a few temporary glass structures, makes the attempt, and sometimes not an unsuccessful one." "Innumerable failures and disappointments have arisen from adopting what are termed cheap modes of culture; again, the thirst for novel theories and marvellous experiments predominates to such an extent, that well matured plans and systems, supported by practical authority, are alike contemptuously rejected."

"The high temperature necessary to bring the pine-apple to perfection renders it an expensive fruit to cultivate; yet, when we reckon its intrinsic value, in conjunction with its distinguished position in the dessert, it is, perhaps, the cheapest, because it is indisputably the best of all exotic fruits. There is none that will so amply repay the gardener for his watchfulness, nor any I know, on which he can calculate with such *certainty*: care, labour, and attention must here insure him an abundant and valuable return." (p. 4.)

Chap. II. treats of the kind of structures in which pine-apples are grown, the modes of heating, and the different systems of culture. Mr. Glendinning considers two kinds of structures necessary, to be differently treated: a pit for growing the young plants in tan, which may be excited by linings of dung; and a fruiting-house, also, with a tan-pit. Hot water, he considers as the preferable mode of heating the fruiting-house. He allows that the pine-apple may be brought to perfection without bottom heat; but that this mode of cultivation will be "attended with additional trouble to maintain the indis-

pensable degree of humidity and heat, and prevent that fluctuation in either, of which an atmosphere so charged would be extremely susceptible." "The safest and best plan to adopt, is that, which combines a bottom heat with an otherwise excited atmosphere." This chapter is illustrated by a section of a pit to be heated with linings of dung; and by a section of a stove with a bark-pit, the atmosphere of which is to be heated by hot water. On the drawing of these sections we will make a remark for Mr. Glendinning's benefit as a garden architect, which is, that, in the flooring of his bark-pits and pits for dung linings, the bricks are shown bevelled off in a manner that would never do in practice. This mode of representing the bricks is probably a mere mistake of the draughtsman; but, as these sections, in point of general form and arrangement, well deserve to be taken as models, nothing ought to have been introduced into them but what is plain and practicable.

Chap. III. treats of the different sorts of pine-apples, proper soil, &c. Mr. Glendinning prefers turfy loam from a clayey soil, mixed with deer or sheep dung, at the rate of 3 to 6, with 1 part of leaf or vegetable mould. When these have been mixed, and lain together three or four months, they are fit to be chopped up for use. They form a rough cloddy mixture; but in such a soil, the roots grow with much greater vigour than in one of finely sifted mould. Mr. Glendinning had two specimens of soil sent him from the Bahamas, in which the pine luxuriates in that country: they are of a stiff light brown loam, and that which is marked the best approaches to a perfect clay.

Chap. IV. treats of potting and plunging, &c.; Chap. V. of the management of the bark-bed, watering, liquid manure, &c.; Chap. VI. treats of the atmosphere, shading, &c.; and Chap. VII. of insects, concluding with a monthly table of temperature, and the following passage:—

After giving an account of a gentleman who had discovered a mode of growing pine-apples of enormous size at the expense of one penny each, he adds: "After some years of absolute failure, the same gentleman applied to me for *some advice* on the subject. Another gentleman, who had been pretty fortunate in this department of forcing, had seen some plants growing very well on what is termed *Mr. Knight's* system, and immediately set about filling up his pits, and placing his pots of pine plants, like so many geraniums, on a stage, without apparently being aware of the necessity of a different treatment being necessary from their first insertion as crowns and suckers, and alike ignorant of maintaining a very different circumambient atmosphere. The result, as might have been expected, was utter failure, and recourse was had to his former mode of culture. Indeed, I could adduce many such examples of the infatuation in lovers of wonderful inventions and marvellous discoveries."

On the whole, this little tract is highly creditable to Mr. Glendinning, and will be found a valuable assistant to the young pine-grower. When it comes to a second edition, which we hope it will soon do, we would recommend Mr. Glendinning to shorten some of the sentences, so as to render them more easily understood by the ordinary reader, as well as to omit or change some terms, such as adlucing process, desiccated atmosphere, &c.; for his style is rather ambitious, a common fault in young authors.

The pine-apple, being a monocotyledonous plant, is, as such, subject to certain laws; as a native of a tropical climate, it is subject to laws of another kind; and its artificial culture must rest on these two sets of laws as a foundation. In common with all monocotyledonous plants, the pine-apple suffers much by a check in its growth; for monocotyledonous plants which are natives of hot climates either grow all the year, as the pine-apple, which is a native of moist shady woods; or they grow rapidly at a particular season (the rainy season), and then become dormant for the rest of the year. Even the monocotyledonous plants of temperate regions, such as our bulbs, grow rapidly in the spring, and, after flowering, die down to the ground, and are in a dormant state three fourths of the year. The perennial grasses of temperate regions are in a state of continual growth. Again, the

roots of all monocotyledonous plants are, like their stems and leaves, simple in their constitution. From the hyacinth up to the palm, they seldom or never separate into branches; and hence no one ever thinks of shortening the roots of a pine-apple or a hyacinth, in order to increase the number of their spongioles. When the roots of these plants, and even those of the asparagus (which, as they branch a little, may be considered as forming an exception), are shortened, they invariably die back to the collar or plate, and no good is done till new roots are sent out from the plate. Hence the practice of disrooting pine-apple plants, that is, cutting off all the roots close to the stump, is theoretically proper; because, if they were only shortened, the parts which remained would be of no use. The circumstance of the roots of monocotyledonous plants in general not branching, but merely elongating, shows the necessity, or at least the advantage, of having a great perpendicular depth of soil for them to grow in; and hence the hyacinth and the common onion, when the bulbs are to be produced of a large size, require a rich soil, 3 or 4 feet in depth; and, as the growth is rapid, this soil must be abundantly supplied with water. When the pine-apple is grown in pots, the roots compensate themselves, so to speak, for the want of a deep soil in which they can run perpendicularly down, by running round and round the insides of the pots; and hence the advantage of beginning with small pots, and repeatedly shifting into larger ones, till the whole mass or ball contained in the pot consists of a series of circumvolutions of roots alternating with thin strata of soil; the roots only drawing their nourishment from their extreme points. The same observations will apply to the hyacinth grown in pots. But to render what we have said of much practical value, would require more time and space than we can at present devote to the subject. What we have said is with a view to induce the reading gardener to think on the subject, in order that he may deduce all his modifications of culture from scientific principles, as well as from experimental essays, and from precedent; or, as it is called by philosophers, empirical practice.

*Treatise on an improved and cheap Method of cultivating Asparagus.* By Ninian Niven, Landscape-Gardener, late Curator of the Royal Dublin Society's Botanic Garden, Glasnevin, Author of the "Botanic Garden Companion." Pamph. 12mo, pp. 31. Dublin, 1839.

About nine years ago, Mr. Niven began to pay attention to the culture of asparagus, from being situated in a place where, previously to his management, the crop had always failed. He adopted as a principle the enriching of the surface soil and the encouragement of the surface-feeding roots, in opposition to the usual practice of deep trenching and deep manuring. We can easily conceive that the result of this would be earlier and better-flavoured heads; but Mr. Niven also found that the produce of cultivation on the surface-feeding principle was even more bulky than that of watery or deep preparation feeding. Mr. Niven plants in rows 4 ft. apart, with the plants 6 in. from each other in the row. The surface of the soil to be planted with asparagus is enriched with half-rotted leaves and rotten hot-bed dung, to the depth of 3 in., to which is added, where it can be obtained, a stratum of sea-weed. Before planting, the ground is laid up in ridges 4 ft. apart, and the roots of the plants are "set down on the little ridge or saddle prepared for them, as a man sits upon horseback;" a person following with a barrow full of sand, which, with the spade, he "lays over the roots and crowns, about an inch thick, observing to tread successively both sides of each line as he proceeds, with one foot, to firm the sand to the plants, so as to secure them from the action of the air, until the process of planting is concluded, when a second and final covering of about 4 in. of rich compost of dung and rotten leaves is to be put over the ridges or lines, which is to be firmly trodden to the line of plants, as before. A small portion of the original surface between the rows may then be thrown up with the spade, right and left, dressing neatly between every two lines as you proceed, and the process of planting, which is exceedingly simple, is finished." (p. 22.)

The produce of two rows, treated in this manner, Mr. Niven has found "fully equal in quantity to any one bed with three rows on it, besides being much superior in quality."

The plants appear growing out of elevated ridges; and in May, when the short grass mowing begins, a portion of grass is shaken in between the rows so as to fill the hollow space quite up to the necks of the plants. This supplies nourishment and retains moisture, while the slight degree of fermentation which takes place, heats the soil and stimulates the roots. When the shoots come up, they are thinned, by cutting away the weakest, "so that by the end of the first season, not more than two, or at least three, shoots are left to grow to maturity on each plant. Proper attention to the thinning of asparagus, in the first instance, immediately after planting, during the first and second years, and afterwards also in cutting for use, is of essential importance towards the future welfare of the plant." Mr. Niven's object is to leave a supply of strong shoots regularly over the bed, in order that the buds formed at the base of these shoots may be strong and fit to throw up vigorous heads next year.

We may here observe that the practice of the market-gardeners in the neighbourhood of London is, to cut over every shoot, whether small or large, up to a certain day in June; after which the beds are left untouched till the time for winter dressing. This, it would appear, is found to be the most profitable mode for a market-gardener, because he sorts his heads into three sizes, and finds a demand for each; whereas the private gentleman's gardener can send no head to table that is not large and finely grown.

But to return to Mr. Niven's practice. In November, when the tops having become yellow are cut over, the crown of the ridge is reduced a little with the hand, and about 4 in. of sea or "rabbit" sand is laid along over the line of plants, while rotten dung, leaves, and sea sand are slightly stirred into the soil between the ridges. But it is needless to go farther into routine culture. Suffice it to say, that Mr. Niven has fully established the superior advantages of surface culture, which, had the subject been duly reflected on, might have been foreseen. The same principle is now being very generally applied to the culture of every description of useful plant, and more especially to the culture of fruit trees. In short, the subsoil is beginning to be considered as chiefly useful as a reservoir of water, and the surface soil as a store-house of food.

We are glad to find Mr. Niven disapproving of cutting the heads of asparagus a few inches below the surface; "for what useful purpose this is done," he says, "we are at a loss to conceive, inasmuch as the white or blanched part of the grass is so usually hard and stringy as to be scarcely fit for use; whereas, by allowing the heads to grow the proper length above the surface, say about 8 in. or so, they will not only still be compact, but the whole of the grass will be tender and eatable." (p. 27.)

We conclude by strongly recommending this tract, which is sold at the low price of a shilling, to all who are anxious to grow asparagus of superior quality. Mr. Niven is now established in Ireland as a landscape-gardener; and we cannot help suggesting to the proprietors of Ireland the idea of employing him, not only as a landscape-gardener, but as general inspector of their gardens, several times a year, with a view to the improvement of their culture and keeping. There are many points of culture and management which the head gardener only requires to have pointed out and explained to him; such, for example, as the general application of the principle of surface culture, and the consequent necessity of mulching in the dry season, and of thatching the vine borders of forcing-houses in the winter season. In how many cases are not the fruit trees in kitchen-gardens barren from being too deeply planted, or from having the ground too deeply dug about their roots. There are yet hundreds of gardeners of the old school, both in Britain and Ireland, who do not understand the use of leaves, and who persist in the practice of cutting down all plants the moment they have done flowering. Such an inspector as Mr. Niven, at once scientific, of an engaging address, and kind-hearted, might do

an immense deal of good by explaining matters of this kind to gardeners and their employers throughout Ireland; and by repeatedly visiting the same place, so as to make certain that his instructions and suggestions were carried into effect. It is very difficult, however, to convince a gentleman of the importance of scientific knowledge to gardeners, who has no kind of scientific knowledge himself.

*Transactions of the Society for the Encouragement of Arts, Manufactures, and Commerce, during the Session 1837-8.* Vol. LII. Part I. 8vo, pp.170, woodcuts. London, 1838.

The most valuable article for the cultivator, in the present part, is one on hoeing wheat, by Col. Le Couteur of the Island of Jersey, whose work *On the Varieties, Properties, and Classification of Wheat* we have noticed in Vol. XIII. p. 607. In the paper before us, Col. Le Couteur has shown that the proper time for hoeing wheat is when the coronal roots first protrude from the stems, in spring. If these roots, "on emerging to perform their office, find themselves in a hard dry soil," or among numerous weeds, the wheat plants receive a check, and change from a healthy green to a sickly yellow; but, if at this period "a deep, careful, and rapid hoeing" be given, a sudden and extraordinary change will soon take place, and the plants will become of a dark green, vigorous, and spreading. Where land is foul, a second hoeing is required; but this must be "exceeding light and superficial, merely to skim off any weeds that may have sprung up since the first hoeing, in order not to cut or disturb the coronal roots. Here, then, we have the hoeing of wheat founded on a particular principle; as the hoeing of field crops generally is founded on a general principle. Col. Le Couteur uses a hand-hoe, formed like the common Dutch hoe of gardens, but with a narrower and sharper cutting blade. At the end of his paper, Col. Le Couteur mentions that he grew, in the year 1837, 260 varieties or subvarieties of wheat, including the 54 sorts sent us by M. Vilmorin, of which an account is given in our Vol. XIII. p. 45., and which we distributed to Col. Le Couteur, Mr. Taylor (see p. 92.), Mr. Gorrie (p. 24.), Mr. Rivers (p. 23.), and others. Of the 260 varieties grown by Col. Le Couteur, he says, "some have ears greatly increased in size, being 8 and 9 inches long, two or three inches longer than their original types; but the moist weather which prevailed at the period of ripening, discoloured them so much as to destroy their beauty, and almost their resemblance to the parent."

Another paper in the *Transactions* describes a "a ball valve for shallow water cisterns," which may be useful in the immediate neighbourhood of large towns, where gardeners receive their supply of water from public companies. There is also an account of "an adjustable step-ladder," which may be found extremely useful in pruning standard fruit trees growing on sloping ground, or on any description of irregular surface. "Each of the two legs of the step-ladder is furnished with a sliding piece, by drawing out which, the legs may be either equally or unequally lengthened."

*A Dictionary of Arts, Manufactures, and Mines: containing a clear Exposition of their Principle and Practice.* By Andrew Ure, M.D., &c. Parts. VIII., IX., and X., p. 873. to p. 1334., which complete the work. 8vo, numerous woodcuts. London, 1839.

This excellent work is now completed. In the numbers before us are a great many articles interesting to the gardener and the domestic economist. Mustard, under which the French mode of preparing is given, well deserves the attention of cooks; Oils, in which a list is given of the plants which furnish the principal oils of commerce, the most productive of which are the cocoa nut, next the *Ricinus communis*, *Resèda lutèola*, the *Euonymus europæus*, and common flax. Pine-apple yarn and cloth is an interesting article; as is Pit Coal, which occupies many pages, and is illustrated by numerous

cuts; also Potato, Potash, Pottery, Putrefactions, Pyroligneous Acid, Resin, Saffron, Salt, Scouring, Slates, Soda, Sponge, Stained Glass, Starch, Stone, Stone (Artificial); Stove, in which is an extract of two pages and a half from an article by the doctor in the *Architectural Magazine*, though that work is not once referred to; Sugar, including Beet-root Sugar and Maple Sugar; Sulphur, an article frequently used by gardeners; Sumach; Tan, including a table showing the tannin in 100 parts of a variety of substances; Tea; Thermostat, an apparatus for regulating temperature, invented by Dr. Ure, but never, as far as we have been able to learn, used by any one but himself; Tobacco, Ventilation, Wax, Wells (Artesian), Wheel Carriages, Wine, Wood; and finally Zinc, which may be used for various purposes in gardening, and, among others, very conveniently and economically for plant labels.

The immense mass of valuable original matter in this volume, and which is to be found nowhere else, must insure it a place in every library.

*Illustrations of Mechanics.* By the Rev. H. Moseley, M.A. F.R.S., &c. &c. 8vo, pp. 436, numerous cuts. London, 1839.

*A Treatise on Mechanics, applied to the Arts; including Statics and Hydrostatics.* By the Rev. H. Moseley, M.A., &c. Second edit. improved. 8vo, pp. 310, numerous cuts. London, 1839.

The object of these two works is, to explain the mechanical principles of action of the more common objects both of art and nature, to persons who have no knowledge of mathematics, or who have made but little progress in mathematical reading. As far as we are aware, they are the only works having that object which have yet appeared in this country, unless we except *Animal Mechanics*, in two numbers, published by the Society for the Diffusion of Useful Knowledge, and some parts of Dr. Arnott's *Physics*. Both Mr. Moseley's volumes deserve a place in every garden library.

*The British Almanack of the Society for the Diffusion of Useful Knowledge, for the Year 1839.* 8vo, pp. 96. London, 1839.

*The Companion to the Almanack; or Year Book of General Information, for 1839.* Sm. 8vo, pp. 252. London.

These singularly cheap and truly useful works continue to appear annually. In the *Companion* for this year the first paper is on the supposed influence of the moon upon the weather, the result of which is that this difference is very trifling; at the same time, the author observes, "I think that the determination of any well defined lunar inequality in the atmospheric pressure, however small, would be of great interest," although it would be of no service in prognostication of the weather; for "nothing can be so utterly groundless as the disposition to refer the ordinary changes of the weather to the influence of the moon."

The next article is "On the Electricity of the Atmosphere;" a long and most interesting paper, containing a general view of the present state of knowledge on this subject, and from which we shall endeavour to extract the essence, in so far as we think it will be interesting to the practical gardener; premising, however, that, to those who take an interest in the subject, the volume is worth purchasing for this article alone.

Electricity is an element which seems to be "universally present with all aerial changes, but is yet so far anomalous, that we cannot discover any essential part it has to perform, nor any useful influence which it exerts in the natural system of the atmosphere." Nevertheless the cultivation of the subject, by accounting for particular appearances in a satisfactory manner, may eradicate superstition and prejudice, and may prove practically useful in various ways. The conducting rod, the consequence of Franklin's discoveries, while it preserves houses from lightning, by withdrawing from hail clouds the electricity which, by its instantaneous motions, precipitates the more violent



showers, so destructive to vineyards and every other kind of rural crop throughout Central Europe, changes what would be otherwise a violent storm into a gentle shower. But a very small amount of demonstrative truth has been added to the science of electricity since the time of Franklin, nearly eighty years ago.

“In treating of the phenomena of the electricity of the atmosphere, we must premise some remarks on the sources from which it is derived. All the numerous causes of excitation which are constantly in action on the surface of the earth may be said to be sources of more or less of the electricity of the atmosphere. But, as it has been ascertained that one kind predominates greatly, we must look for some origin to which both of these circumstances may be ascribed. The intimate connexion which subsists between the formation of clouds and the development of electricity naturally leads to the supposition of the electricity being dependent upon the vaporous portion of the atmosphere, which is itself liable to similar variations.

“The earlier electricians thought that the vapour necessarily acquired a peculiar electric state in rising from a solid or liquid; but Pouillet, who has recently investigated this theory with remarkable skill, has demonstrated that the conversion of pure water into vapour, at any temperature, is not attended with any disturbance of the electric equilibrium; but that vapour, rising from solutions however weak, gives signs of electricity, varying in kind according to the nature of the substance dissolved. From alkaline solutions the vapour rises with the signs of — electricity; from saline or acid solutions the vapour carries up a charge of + electricity, and leaves the solution in a state of — electricity; and the rule was verified, particularly with regard to solutions of sea salt. It cannot be doubted, therefore, that evaporation from the surface of the sea forms a copious source of atmospheric electricity; and, as no natural collection of water is absolutely pure, lakes and rivers, and the humid soil, must add to it.

“Besides this important modification of the former theory, Pouillet has, by his ingenious and able researches, discovered an unsuspected source. When gaseous bodies unite with each other, or a gaseous body with a solid, one of the uniting bodies always gives out + electricity, and the other — electricity. In the combustion of carbon, hydrogen, oils, &c., the carbonic acid formed by the combination with oxygen is in a state of + electricity, and the unconsumed portion remaining is in the opposite state. As plants, during vegetation, exert a chemical action on the atmosphere, sometimes converting its oxygen into carbonic acid gas, and at others decomposing the carbonic acid already existing in it, assimilating the carbon, and disengaging the oxygen, it was conceived that electricity might be thus developed; and, from the very extensive operation of vegetation, the quantity might be sufficient to influence the atmosphere. The results of experiments confirm this anticipation. When seeds were sown in the earth there were signs of electricity as soon as the germs appeared on the surface; and the electricity became more evident as vegetation advanced. So considerable was the evolution, that it was calculated that a powerful battery might be charged by the vegetation from an area of one hundred square yards. Every green tree and every tuft of verdure is, therefore, continually supplying the atmosphere with electricity; and in hot humid climates, as that of Brazil, the quantity derived from this source must be extraordinary, if we reflect on the vigour with which the growth of the plants is carried on. According to the assertion of a respectable traveller, rain in the evening will by sunrise have given a greenish tinge to the earth; if the rain continue, there will be sprouts of grass an inch long on the second day; and on the third day the grass will be strong enough for the pasturing of cattle.

“The great sources of atmospherical electricity are, therefore, evaporation chiefly, and vegetation; the others to be noticed are comparatively insignificant, and, perhaps, do not coincide in contributing electricity of the same kind.

“The exhalations from the flowers of plants differ in chemical constitution from those of the green parts, and their formation in the corolla must be

attended with electromotive action. In all probability, the electricity is of the negative or resinous kind, and will thus neutralise a small quantity of the + electricity rising at the same time

“In the processes of animal life there are numerous changes, in which electricity is necessarily extricated; but the amount thrown into the atmosphere in this way is thought to be but trifling. Volcanoes and earthquakes are sources of atmospheric electricity, but this department of the subject has not yet been investigated.

“If the surface be covered with water, humid soil, or vegetation, the evaporation and consequent electricity will be increased in proportion to the velocity of the wind; but when ground is so parched that the moisture is entirely exhaled, the air above it partakes of the drought, and both bodies, by their nonconducting qualities, retain the electricity developed, either by the air moving on the surface, or by that which ascends among the dry and heated particles of sand.

“Having thus pointed out the various sources, we may remark that, though each of them must be had regard to in particular cases, yet that the electricity which is constantly present in the atmosphere can be derived only from the process of evaporation, than which there is no other sufficiently copious or prevalent, and corresponding in its fluctuations. Even the electricity of vegetation is subordinate to that, as assimilation in plants is vigorous according to the rapidity of evaporation; and the electricity, on being communicated to the atmosphere, leaves the oxygen or the carbonic acid, for the vapour nascent at the same time, as the better conductor. The electrical effects of the other causes which have been mentioned may be compared, in their amount, with the influence of animal heat and artificial fires, perceptible enough in a small compass, but not interfering with the general distribution of temperature.”

It is assumed, therefore, as a general principle, that the electricity of the atmosphere follows the course of the aqueous vapour. It is continually received from the earth into the atmosphere, and as continually returned to it; its distribution never being equable, but disturbed by the formation of clouds, “in which it is detained, and by the mingling of different strata by the winds, which, bringing successive portions of the air into contact with the earth, the electricity is again absorbed. As might be expected from the nature of the exciting causes, the quantity is extremely variable, according to the climate, the season, and the time of day. In hot climates, not deficient in humidity, it is more abundant than where the air is cold and dry.” In Equinoctial America the intensity of the electricity is much greater than in Europe; and in the polar regions it can scarcely be detected. Change of season is attended with the same variation in electricity, as is produced by difference of climate. Electricity undergoes a succession of changes during every twenty-four hours. “It is first perceptible soon after sunrise. The rise at sunset must be owing to the formation of dew, by which the electricity attached to the vapour is contracted into less space, and its intensity proportionably increased. The oscillation evidently follows the course of the vapour, but it must be understood that its regular outline can be traced only in calm and serene weather, being disturbed by whatever affects the temperature and vapour. By the influence of condensing vapour there is an inversion of the distribution, which ensues in a homogeneous atmosphere. The electricity which has been concentrated in the planes of aqueous precipitation gradually communicates itself to the surrounding air, its intensity becoming weaker as it recedes from the plane. The change is, therefore, stronger as we ascend above the earth. In connexion with this part of the subject, we may mention the periodicity of thunder storms. When the temperature begins to decline, clouds which have formed become more dense, in consequence of receiving additional vapour without a corresponding supply of heat. They may again evaporate, if the neighbouring air be not nearly saturated; but often they are precipitated in showers, after which the weather again clears.

The falling of the drops opens a communication by which the electricity accumulated in the cloud is restored to the earth by conduction. When the intensity of the electricity is great, however, it may overcome the resistance of the air, and, by discharging itself, hasten the commencement of the shower, or even determine the precipitation of a cloud, which might otherwise have evaporated. As the temperature arrives at its maximum at the same time of the day, it is not surprising that the transient storm should occur at the same hour of the day during the continuance of the same kind of weather. This has been observed to happen even in our variable climate, on three or four successive days.

“The intensity of the electricity of the atmosphere has been found by Mr. Crosse to be according to the following order of kinds of weather :—

- |                                       |   |
|---------------------------------------|---|
| 1. Regular thunder-clouds.            | 10. Sky obscured by clouds.   |
| 2. Driving fog, with small rain.      | 11. Mackerel, or mottled sky.   |
| 3. Fall of snow, or brisk hail storm. | 12. Sultry weather, with light hazy clouds.   |
| 4. A smart shower, in a hot day.      | 13. Cold damp night.  |
| 5. A smart shower, in a cold day.     | 14. Cold dry east winds, affecting the feeling to a degree not corresponding with the thermometer.” |
| 6. Hot weather, after some wet days.  |   |
| 7. Wet weather, after some dry days.  |   |
| 8. Clear frosty weather.              |   |
| 9. Clear warm weather.                |   |

The weakness of the electricity which is diffused through the atmosphere makes it incredible that it can have any of the effects which popular opinion ascribes to it, under the designation of “thunder in the air.” It is said to blight vegetation, to taint butcher’s meat, to turn milk sour. We may, with more reason, ascribe these effects to the high temperature and humidity than to electricity, which is more intense in a snow storm or a hail shower (as may be seen in the preceding table), than in the kind of weather in which they are produced. With respect to its supposed influence on the human health, the same causes, combined with diminished pressure, are sufficient to explain the sickness, low spirits, nervousness, and feeling of general discomfort, arising from the contrary actions of stimulation from heat, checked perspiration, and more languid circulation.

The meteorological phenomena caused by simple communicated electricity are somewhat interesting, and are quite harmless, but often give rise to groundless terror among the ignorant or superstitious.

These we must pass over, noticing only a remarkable instance of the electricity which may precede a storm, before any threatening appearances are seen. On one of the bastions of the Castle of Duino, on the shores of the Adriatic, there had existed from time immemorial a pointed iron rod, placed vertically. In the summer, when an approaching storm was apprehended, the sentinel on the bastion presented a halbert to the iron, and when he perceived it to emit sparks or display a small sheaf of fire, he rang a bell to give notice to the country people in the fields, and the fishermen at sea, to seek shelter from the approaching storm.

The writer next considers atmospheric electricity in a state of local accumulation in clouds, in which the intensity of the charge in the cloud is ultimately determined by the rapidity of the condensation of the vapour, and the distance of the cloud from the earth or conductors. The destructive powers of electrical discharges are to be estimated, not by the intensity of the charge within the cloud, but by the quantity; for the greater part of the charge of an extensive cloud may be concentrated into a flash of lightning of small dimensions. “The force of the electricity is proportionate to the square of the thickness of the stratum, and, clouds being most frequently of a flattened form, there is a tendency to diffusion or discharge rather from the edge and circumference than from the central part.” “The path of the electricity is not a straight line between the discharging points; but it is never capricious, being previously probed, as it were, by the subtile fluid which penetrates all

the neighbouring matter, and ascertains the track in which there is least resistance. It is thus sinuous, zigzag, or branching, on different occasions. When the electricity has passed, the air, which has been forced asunder, again rushes into the partial vacuum, and gives rise to the thunder, or the report which follows the discharge. The rolling of the sound is caused partly by the echoes, partly by the report from different points in the track reaching the ear in succession. It is rather the volume than the intensity of the sound which makes it so awful. The loudest peal of thunder can scarcely be heard at the distance of ten miles, and is therefore of less intensity than the report of a cannon. When the air is favourably disposed for the conduction of the electricity, the discharges may be very frequent, but weak, so that no report follows, and the flash is invisible by day. This is what is termed heat-lightning, or sometimes sheet-lightning, though erroneously; the name referring to the recurrence of the lightning on warm humid nights."

The author next accounts for remarkable electrical appearances, such as balls of fire, and other meteors, whirlwinds, pillars of sand, and water-spouts; but this very interesting part of the article we must pass over; earnestly recommending the reader to study the original, which will be found not less entertaining than original and instructive.

Electricity appears to be an agent, which, like heat, is everywhere in operation, both in the earth and air. Every new mixture of earths in the soil, or of earth and air, by turning it over; and every addition of water to soil, occasions electrical changes; and these, it may easily be conceived, must have a powerful influence on plants. Though the subject is still in its infancy, it may be considered of the greatest importance to scientific cultivators, as explaining many phenomena, not otherwise to be accounted for. At all events, when gardeners are watering, abstracting water by draining, mixing soils, adding manures, stirring the surface, digging or trenching, they may consider themselves as preparing the way for electrical changes, which, at some future day, will be accounted for in a more intelligent and specific manner than they can be at present.

Art 3. is on the application of arithmetic to medicine, which shows in a striking manner the great uncertainty of that art as at present practised.

Passing over a number of articles, we come to 24. on Public Improvements, in which many new public buildings are described and criticised, and some beautiful engravings are given.

Two new cemeteries are about to be formed in the immediate vicinity of the metropolis; one to be called the Abney Park Cemetery, at Stoke Newington; the other the West London, at Earl's Court, Kensington, for the buildings connected with which latter there has been a competition, and the designs were sent in on the last day of August. Another more embryo project is that for establishing a public botanic garden in the Regent's Park, the spot selected for the purpose being the whole of the inner circle, which it is intended to lay out in gardens appropriated to plants of different countries, and to ornament with a variety of characteristic buildings. Of these, one of the principal is to be a large rotunda, or circular conservatory, in the very centre, to which a grand promenade will lead directly from the chief entrance, raised on a viaduct or terrace, fenced by balustrades with vases, &c. There will likewise be a very extensive piece of water, forming a deeply indented lake, studded with islets. In conclusion, we strongly recommend this Almanack and Companion as the most suitable work of the kind for gardeners that we are acquainted with.

*The Bee-Keeper's Manual, or Practical Hints on the Management and complete Preservation of the Honey Bee.* By Henry Taylor. Second edition, enlarged, and with numerous additional illustrations; 12mo, pp. 126. London, 1839.

The first edition of this useful little work was noticed in Vol. XIV. p. 295., and, as the author did not think we had altogether done him justice, his

retrospective criticism on our review will be found in the same volume, p. 349. In this second edition of the *Bee-Keeper's Manual*, "the author has been induced to extend the original design and application of this little book, by entering somewhat more *generally* into the subject of the economy and management of bees. Practical utility, without unnecessary prolixness, has still been his main object; and we trust that the improved arrangement, additional information, and variety of illustration, which have been introduced, will render superfluous any apology for an unavoidable increase in the size of the book.

"If we shall have contributed to aid in abolishing the still too prevalent and cruel custom of destroying bees in order to obtain their honeyed stores (a practice nearly unknown beyond our own country), the author will deem no time or trouble misapplied in showing that the interest of the proprietor is best consulted by an observance of the claims of gratitude and humanity." (Pref.)

The work is illustrated by various additional engravings, and may be consulted with advantage by every one who keeps bees, and more especially by such as have tried Nutt's hives, or any hives the object of which is to take the honey without destroying the bees. The author has noticed all the various systems that have been adopted for this purpose, and given his opinion of them with candour and impartiality.

The only circumstance to be regretted with respect to Taylor's hives and Nutt's hives is, that they are rather too dear for the labouring man. Now this evil might very easily be remedied, if some of the patrons of bee culture would induce a Scotch joiner to go and settle anywhere in Norway; say, for example, at Christiania or Dram, and there manufacture bee-hives, cottage furniture, and innumerable other articles for the poor, and send them over to this country. The price of labour and material is so much lower in Norway, that the articles could be furnished in any British port, ready made, for less than we should be obliged to pay for our material. As a proof that this is really the case, we refer to the garden fold-up seats, which are sent over from Norway to Liverpool, and which, after being carried to London, are sold in Charlwood's seed-shop, and at various other places, at 2s. 6d. each. We hope some one, Mr. Laing, for example, or John White, Esq., of Westbourne Green, who has an extensive estate in Norway (see *Arb. Brit.*, vol. iv. p. 2170), will open the eyes of the Norwegians to this source of industry and commerce. We understand that the Norwegians build portable wooden houses for Australia, and we see no reason why they should not manufacture minor articles of deal and oak for Britain and other parts of the world. It would certainly contribute greatly to the comfort of the cottager, if he could get all his household furniture, and his hot-bed frame, shelves, bee structures, and tool handles, at a fourth part of the price which he does at present.

#### GERMAN.

*Grundzüge einer neuen Theorie der Pflanzenzeugung. A new Theory of the Reproduction of Plants.* By Stephen Endlicher. Pamph. 8vo, pp. 22. Vienna, 1838.

We notice this tract in gratitude to the esteemed friend who sent it us; for the subject is far too hypothetical to be entered into with the slightest probability of its being useful to practical men. In the dedication, "An Herrn Robert Brown, Esq., in London," the author states that, in 1835, he endeavoured to explain his views to that gentleman, on whose discoveries he says he has founded his New Theory. Dr. Brown "listened with forbearance" to a doctrine which "appeared paradoxical;" viz. that the pollen was not, as hitherto supposed, a fertilising powder, but the actual seeds of the plant, which, being sown on the stigma, germinate on it, and strike down their roots to the ovule.

ART. V. *Literary Notices.*

*ILLUSTRATIONS of Indian Botany*, or figures illustrative of each of the natural orders of Indian plants described in the author's *Prodromus Floræ Peninsulae Indiæ Orientalis*, with observations on the botanical relations economical uses, and medicinal properties, including descriptions of recently discovered or imperfectly known plants. By Robert Wight, M.D. F.L.S. &c., surgeon on the Madras establishment. Imported from Madras in 4to parts.

*Icones Plantarum Indiæ Orientalis*, or figures of plants. Also imported.

*Kollar's Insects* injurious to gardeners, foresters, &c., will appear in the first week of June.

*Repton's Works on Landscape-Gardening*, No. I., 2s. 6d., to be completed in ten numbers, will appear about the middle of May.

*Horticultural Exercises for Schools.*—We observe with pleasure that, through the exertions of Mr. Simpson, Mr. Wyse, and others (including Mr. Hume, who was one of the very first members of Parliament who expressed a decided opinion on the subject, many years ago, in a letter in the *Morning Advertiser*), the subject of a national system of education is beginning to be agitated; and we therefore think this the proper time to give notice of a kind of school book that we have had in contemplation ever since we saw the school gardens of Bavaria, in 1828. (See *Gardener's Magazine*, vol. v. p. 692.; and our French pamphlet entitled *Des E'tablissemens pour l'E'ducation publique en Bavière dans le Wurtemberg et à Bade*, &c., Paris, 8vo, 1829.) In the school book which we contemplate, we intend to describe all the ordinary implements of the manual labours and operations used in gardening and agriculture; and to show the mechanical principles on which the implements are constructed, and the operations performed. We shall begin, for example, by showing what may be called the mechanics of the human body; viz. the different actions of the muscles and bones, and the changes of position of the centre of gravity that take place in the elementary movements of rising, standing, walking, running, grasping, lifting, throwing, pushing, and drawing. We shall next take the lever, then the pickaxe, and next the spade, and so on. We shall show that the spade is a lever with a wedge at one end, and a handle at the other; and how, in the operation of digging, while separating the spit it is used as a lever of the first kind; and in lifting the spitful with a view to turning it over or throwing it off, as a lever of the third kind. We shall then show by woodcuts all the different positions of the operator in digging, giving under each cut what may be called the word of command for that operation (such as seize spade, enter spade, lift spade, turn spade, &c.), and which the teacher may give to his pupils, one after another being made to go through all the different movements; or if several spades can be got, digging may be taught in the garden in classes, as soldiers are drilled in corps. We shall next state the uses of the spade in all the different country operations that are performed with it, such as excavating, heaping up, levelling, &c.; and, in speaking of trenching and digging, we shall show the use of these operations to plants, in rendering the soil more easily penetrated by the roots, increasing its nutritive powers by the intermixture of manure, in facilitating the admission of rain and of heat by its greater porosity, and for the same reason increasing its nonconducting properties of both heat and moisture.

In like manner, we shall go through all the tools, instruments, and hand machines, used in the manual labour of the gardener, the forester, and the general country labourer, giving engravings of every implement, and of the different steps in performing every operation; thus rendering the whole so clear as to be taught to boys at school in masses, and more as an agreeable recreation than a difficult task.

It is scarcely necessary to enlarge on the advantage that would result to boys when they became men, from being taught country labours and operations scientifically. It would enable the working man to perform them in the best

manner, with ease to himself, and without injuriously straining the implements used, without any other teaching; so that an apprenticeship to a young man intended for a gardener would be rendered in a great measure unnecessary. The independent gentleman, who has been taught these exercises when a boy, will be enabled to employ them when a man as a source of recreation; which will have the advantages over field sports, of being useful as well as more rational and more humanising, as enabling him to sympathise with the labours of all the country workmen on his estate. To boys, whether destined to be workmen or to inherit property, a knowledge of garden and field operations can hardly fail to communicate a taste for gardening and agriculture; and this taste, whether in the poor or rich, is universally acknowledged to be a source of domestic comfort and happiness.

We have gone somewhat into detail in this notice, in the hope of inducing others to produce similar school books for different mechanical trades: one for carpentry, for example, one for smith's work, and one for masonry and bricklaying. The operations of these trades, and of garden and field culture, ought, in our opinion, to be taught at school to all boys whatever; by which means they would be fitted for gaining their bread in any country in the world, whether new or old.

A similar series of school exercises in household matters of every kind ought to be contrived for girls.

## MISCELLANEOUS INTELLIGENCE.

### ART. I. *General Notices.*

*ACCLIMATISATION of Plants.*—The desire to naturalise the many beautiful flowering shrubs and trees, natives of warmer skies, is natural to every lover of plants in this and other northern countries. In furtherance of this object, many experiments have been made to ascertain whether the denizens of warmer climes may be inured to the chilly air and frost of our northern latitudes. Some botanists have imagined that tender plants have a predisposition or constitutional mutability, by which, whatever may be the temperature of the station they are placed in, they will accommodate themselves thereto. But no rule of practice has been founded on this idea; on the contrary, nothing but the actual and gradual exposure of the plants we wish to acclimatise can be a certain test of their ability to bear the rigours of a colder climate. By such trials, the *Aúcuba japónica* was found to be perfectly hardy. Many South American, Chinese, and Australian plants have been found to be half-hardy; and, before this last winter (1837-8), many curious kinds from the above-mentioned countries were supposed to be hardy, which are now dead, or nearly so; the roots only of many of them remaining unharmed. But the frost of last winter was uncommonly severe, many of our hardiest natives having suffered.

That the texture and consequent susceptibilities of plants are varied according to the aspect, or moisture, or poverty of the soil in which they grow, is perfectly obvious. The growth is retarded by cold, drought, and by want of sufficient nourishment; and accelerated by heat, humidity, and by a rich generous soil. Of course, the plants on the north side of a gravelly hill, whether indigenous or exotic, are of a firmer texture, and much more hardy, than those on a rich southern slope. This is the reason why plants in an irriguous valley are sooner destroyed by frost than those on the bleak hill; and also why plants tenderly nursed up are sooner damaged by a colder temperature than if reared in full air. The membranes, in the last case, being more compact and juiceless, and in the other more attenuated and succulent; and, according as these circumstances are more or less extreme, the plant is more or less liable to be destroyed by frost.

The action of frost upon vegetables shows itself in two ways: some plants are only withered by it, but without any disruption of the membranes; and, on the return of a thaw, the leaves regain their rigidity and vigour as completely as before. Other plants, from their natural or accidental succulence, delicacy of membrane, and abundance of watery sap, are, by the internal crystallisation of their juices, rent into shreds, and totally dismembered. Plants having a resinous sap seldom suffer from frost; because no crystallisation of such sap (to hurt the tubular structure) takes place, and thus such plants escape.

The effect of extreme heat and moisture on vegetation excites it to its utmost expansion. Plants, natives of the temperate zones, if exposed to such excitement for a longer time than their natural summer, become eventually quite exhausted, and die in a few months. This happens to many European plants when carried to India, such as the pear and apple trees; and even the grape vine lives in a very weakly condition, and is but partially fruitful, unless grown on the highest hills.

Where vegetation is deficient, there animals are mostly carnivorous; and, where vegetables abound, roots, stems, leaves, and fruit are, for the most part, the food of every living creature. (*Flor. Cab.*, vol. ii. p. 90.)

*The Effect of severe Frost on Plants.*—I have been endeavouring to make out something relating to the effects of frost on different kinds of vegetation, but cannot satisfy myself at present on the subject. All dry substances are less affected by frost than such as are of a moist nature; consequently some kinds of bark, and woody fibre generally, will be less liable to injury than such parts as have a watery basis. The latter must, in a great measure, come under the law by which water undergoes an expansion of volume when converted into ice; and, as this expansion would take place, although confined by a pressure equal to that which would burst a cannon, I cannot conceive how the tender tissue of plants, or even woody fibre, could be preserved from being totally ruptured, unless a compensation were provided for such expansion by a proportionate number of *air-vessels*; and, as the air is not increased, but, on the contrary, goes on diminishing in volume after the watery fluid has passed its minimum state of contraction, room perhaps may be, in consequence, afforded for the adjoining cells to expand, as the fluid they contain is being congealed and expanded. The green leaves of such plants as the holly and ivy, that withstand severe frosts, are, perhaps, protected by some oleaginous substance.

I observed an instance of the destruction of the bark and cambium in a China rose trained against a wall; whilst the wood admitted the free ascent of sap, and young shoots, leaves, and flowers were afterwards made in tolerable profusion: but the return of juices elaborated by the above-mentioned foliage was completely intercepted by the disorganised state of the vessels exterior to the wood; and the consequence was, that the juices, in attempting a descent, burst the bark, and formed callus-like excrescences. As soon as this was observed, the stems ought to have been cut down; for the wood drained and exhausted the roots, without the latter being able to receive the usual descending supply. In the course of the summer, about the time that the young shoots ought to have been receiving a supply direct from the roots through channels of fresh albumen, they began to languish, and ultimately died.—*J. W. L. Nov. 17. 1838.*

*Importance of Selection in setting apart Plants for producing Seed.*—Mankind seem to be just beginning to be aware of the remarkable fact, that mental properties and peculiarities may be transmitted from parents to offspring, as well as physical properties and peculiarities; or, perhaps, we should rather say, that mental and physical properties alike depend on organisation. It has long been observed in a general way, that the offspring resemble the parent in form and disposition; but it has only in a very few cases been noticed that the same thing also takes place in regard to taste. It was mentioned of the man with the iron mask that he was remarkably fond of fine linen; and as this was also the case with Anne of Austria, the then dowager queen of France,



it was taken as a part of the evidence in favour of the opinion that he was her son. If we consider all mental qualities whatever as the result of organisation, the importance of selection in breeding will be obvious; for, assuredly, if the taste, good or bad, can be perpetuated from father to son, the habits, good or bad, may be perpetuated also. Our attention has been directed to this subject by a Report made to government on the State of Crime in Scotland. The author of that Report, Mr. Hill, says, "crime appears to be not only hereditary to a considerable extent, but also in some degree to belong to particular occupations." Carters he finds more addicted to stealing than any other class; and colliers and fishermen, though addicted to drunkenness and to committing assaults, are for the most part honest. On this part of Mr. Hill's Report the enlightened and philosophic editor of the *Scotsman* observes, "Mr. Hill notes the fact, which could scarcely escape so careful an observer: that in many cases crime appears hereditary. He might, however, have gone farther than he does on this subject. Our belief is, that when the son of a criminal walks in his father's footsteps, the effect is not so frequently, as he imagines, the simple consequence of bad example and neglected education, but very often of a disposition to crime which the child receives from the parent with the elements of its existence. In a sound system of penal legislation, the truth or falsehood of this principle is of much importance. If some men are born with an irresistible propensity to cheating, thieving, or acts of violence, they ought to be regarded as moral patients, like idiots and lunatics, and subjected to a very different discipline to what is applicable to individuals whom an accidental combination of unfavourable circumstances have seduced into crime." (*Scotsman*, April 21, 1838.) A reference to these observations may to some of our readers appear to have little connexion with gardening; and we readily admit the want of direct relation between these statements and any thing that takes place in breeding plants. If, however, we can strongly impress on the mind of the young gardener, the fact of like producing like, not only in form, temperament, and disposition, but even in morals, and in shades of opinion, and in taste, in the human species; we think we shall not only do him good, in the character of parent, should he ever become one, but render him far more particular than most gardeners now are, in the selection of plants for producing seeds, whether of flowers or of culinary vegetables, and in selecting blossoms of fruit trees for cross-fecundating other blossoms. — *Cond.*

*The Necessity of Selection of Plants.*—If the vast number of plants which are constantly being introduced to this country were to be subjected to the test of well founded and established criteria, and cultivated only when possessed of real and sterling merit, we imagine that many, which are now allowed a place in our collections solely on account of their novelty, would speedily be discarded, and their place supplied with older, but more truly ornamental and valuable species. (*Paxton's Mag. Bot.*, Aug. 1838, p. 145.)

*Cemeteries.*—The first principle of a cemetery, beyond its being made safe and wholesome, is that it should be cheerful in its aspect. For the sake of the dead, this is right, that their memories may be as welcome as possible to survivors; for the sake of the living, that superstition may be obviated, and that death may be brought into the most familiar connexion with life that the religion and philosophy of the times will allow; that at least no hindrance to this may be interposed by the outward preparations for death. (*Miss Martineau.*)

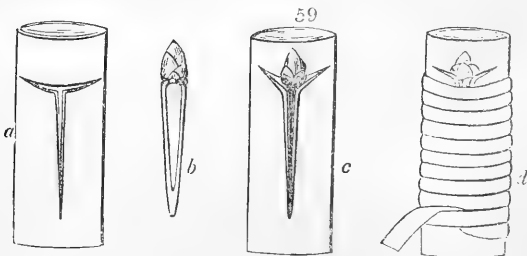
*An economical Pit for forcing Dahlias, &c.*, may be made by building a dry cellar, of from 4 ft. to 6 ft. in depth, under an ordinary pit: the floor of the pit over the cellar may be of large slates, or thin flag-stones placed on iron or wooden joists. On this floor a layer, 9 in. thick, of sawdust, sand, ashes, or rotten tan, may be placed, as a medium in which to plunge the pots of dahlias, &c., to be forced. The heat is supposed to be produced by fresh stable dung thrown into the cellar. (*Cameron in Flor. Cabinet*, vol. ii.) No pit of this kind ought to be attempted except in very dry soil, and we should say

that, in nine cases out of ten, the cellar would require to be made above ground. We have seen the plan tried in loamy soil in the neighbourhood of London, and have tried it ourselves, but always without success.—*Cona.*

*Sporting of Plants.*—A correspondent expresses surprise that a white rose should have produced a red rose on the same branch; and also, that moss roses should sometimes be found without moss, or but partially furnished with that appendage. Such sports, however, are common throughout the whole vegetable kingdom; and it is to them that we are indebted for most of our variegated-leaved plants; for example, our variegated hollies, pines, ashes, maples, &c. In herbaceous plants, double-flowering varieties are frequently sports; as well as those having leaves of abnormal forms or colours. To perpetuate the sport, it is in general only necessary to cut it off, and propagate from it by extension. Mr. Sabine informs us that some new varieties of Chinese chrysanthemums were obtained in this manner in the Horticultural Society's Gardens; but we do not recollect a new variety of fruit having been so obtained.—*Cond.*

*Van Mons's Theory for the Amelioration of Fruits,* more particularly of pears and apples.—According to Van Mons's theory, trees raised from the fifth, sixth, and seventh generations, without interruption, from their first parents, ought to come sooner into fruit, and produce fruit of a better quality than trees of the first generation, or those raised from the first sowing. This, it is alleged by various physiologists, is very doubtful; and, at all events, remains to be proved by facts. As a step towards this, M. Poiteau, in the spring of 1836, received from M. Van Mons 1000 seedling pear trees of two years' growth, raised from the fifth and sixth generations in a direct line from the first parent. These trees M. Poiteau and M. Noisette planted in a favourable situation, at Mont Rouge, in the suburbs of Paris, and they were examined in December, 1837, by a commission named by the Horticultural Society at Paris. The trees were found in a healthy state, but had not then shown flower buds, though M. Van Mons had said that a part of them would fruit at the end of five years. Before planting these trees, the roots were pruned, and all the pieces which were cut off, were planted, and produced shoots; and by means of the plants so raised, MM. Poiteau and Noisette intend to ascertain whether the plants raised from the roots will come into fruit sooner than the seedlings from which the roots were taken. At all events, this is a very ingenious and effectual mode of multiplying seedling rosaceous plants. It is highly creditable to the Horticultural Society of Paris, that, in 1834, they offered a premium of 1000 francs to him who, between that time and 1846, should obtain the best fruit from seedling pears and apples. MM. Poiteau and Noisette, also deserve the highest praise for the exertions they are making to collect together varieties of fruit from all quarters, with a view to proving them and correcting the nomenclature. (*Annales d'Hort. de Paris*, vol. xxi. p. 314.)

*Budding with a terminal Eye.*—The only advantage attending this mode is, that a much longer shoot is produced than when lateral eyes are chosen; the



obvious reason of which is, that the terminal bud, being naturally much more vigorous, has a more powerful capacity of development. Its principal use is

to restore leading shoots; for this mode of budding never can be employed in a general way, for want of a sufficient number of terminal buds. The practice will be easily understood from the figure (*fig. 59.*), in which *a* represents the stock, in which an incision is made in the form of the letter *T*; *b* the bud prepared by paring down the wood on one side, which side is that here exposed to view; *c*, the bud put in its place; *d*, the bud tied to the stock by a coarse woollen thread, or a strand of bast matting. (*Annales d'Hort. de Paris*, vol. xxi. p. 122.)

*Grafting Pinks and Carnations* is said to have been practised in France in the sixteenth century. Some doubt this; but, at all events, it is practised at present by M. Loisel, head gardener to the Marquis de Clermont Tonnerre, at Glisolles, in the valley of L'Ûton, near Evreux; and, in his garden, six, seven, or eight pinks of different colours are found flowering on the same stalk. The operation is performed when the flower buds are about a fourth part of their size; and these buds are inserted in the axils of the leaves of the flower stem of the stock. They are inserted in the slit manner, and merely tied on with a bit of woollen thread. At the end of eight or ten days, the scion will commonly be found united to the stock, when the ligature may be removed. In two or three days afterwards the flowers expand; and, if the varieties have been properly chosen, all those grafted on the same flower stem, will expand at once. In general, the effect of grafting a flower bud, is to retard its expansion from six to eight days. (*Annales d'Hort. de Paris*, vol. xix. p. 68.)

*Grafting the Sweet Chestnut on the Oak.*—This has been performed with perfect success by a gardener at Metz, and the cultivators there anticipate great advantages from being able to give so hardy a stock, and vigorous roots, to a tree which is considered there about as tender as it is in the climate of Edinburgh. (*L'E'cho*, March 7. 1838.)

*Striking Camellias from single Eyes.*—M. l'Abbé Berlèse laid before the Horticultural Society of Paris (July 20th, 1836) a cutting of a camellia with a single eye which had formed roots, taken at random from 1,400 similar cuttings, planted with a view to produce stocks for grafting on, by one of the Parisian nurserymen. (*Annales d'Hort.*, vol. xix. p. 124.)

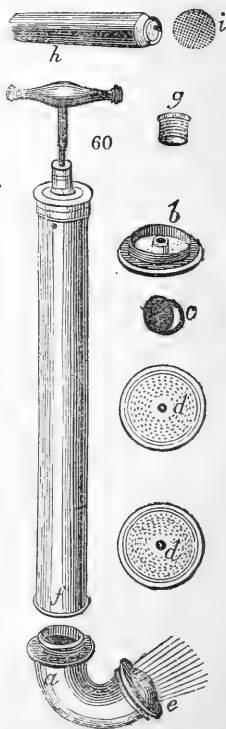
*An improved Method of training Raspberries.*—Cut out all the weakest shoots, so as to leave only about six on a stool; then twist the point of one shoot from one stool with one shoot from the stool adjoining, so as to form an arch. Do the same with two other shoots of each plant, so as to form a triple arch between plant and plant, in the direction of the rows, all through the plantations; the space between the rows being left open as usual. The plants should be 6 ft. apart every way. The fruit produced by the trained canes will be fully exposed to the direct influence of the sun, and to the air, and there will be more room for the suckers. (*Flor. Cab.*, vol. ii. p. 11.)

*Uses of the common Hollyhock.*—A good strong cloth may be made from the fibrous bark of the flower-stalks of the hollyhock. In 1821, about 280 acres of land, near Flint, in Wales, were planted with the common hollyhock, in order to convert the fibres into thread similar to that of hemp or flax. In the process of manufacture it was discovered that the plant yields a blue dye, equal in beauty and permanence to the finest indigo. The seed cases should be collected when ripe, in dry weather, and kept dry, sown in April in beds of light earth, and the young plants removed, when they have six or eight leaves each, into nursery beds, about 12 in. from each other, and watered, if the season be dry, until they have taken root; then kept free from weeds, and planted out where they are to remain until October. Seeds sown as soon as ripe in autumn, and planted out early in spring, will sometimes flower a year sooner than could have been obtained from spring sowing. When not wanted for seed, the choice varieties should have the flower-stalks cut down to the ground when the flowers are decayed, for, if suffered to ripen the seed, it frequently weakens the plant so much, that they decay during the winter. A single flower-stalk will furnish enough seed for a large garden. (*Dunfries Courier.*)

*The Maggot on Onion Crops*, which appears in July, may be destroyed in the following manner. First stir the soil among the plants, and then water them well, either with soapsuds and sulphur, or with lime-water and sulphur. This is best done when the onions are grown in rows, which is always my practice. *Robert M'Nab. Craig, near Dundee, May 19, 1838.*

*Destroying the Caterpillar on Gooseberries.*—Some of my brethren recommend powder of quicklime to be thrown on late in the evening or early in the morning, when the plants are covered with the dew; but this I look upon as a clumsy and needlessly expensive mode. What is it in lime that destroys insects? Is it not the alkali? and cannot this be got by dissolving the lime in water, and then watering the bushes with it, or indeed watering the ground, or any plant where insects or creeping vermin are to be destroyed. Therefore I always use lime-water, and never powder of lime. When I am about to apply it to gooseberry bushes, I take one of M'Dougal's garden syringes, and, screwing on the bent disperser, I apply the water, first under the bushes, which brings down a great portion of the caterpillars, and sends another portion to the upper surfaces of the leaves. To destroy these last I do not use the syringe, but the common watering-pot, with the rose on. The syringe is too powerful an instrument for this purpose, and is apt to cause the caterpillars to drop off, when, in falling to the ground, they cling to some of the branches, and escape, or render it necessary to syringe a second time underneath. Unfortunately, most of my brethren do not attack the gooseberry caterpillar till it is nearly full grown, and consequently has done all the mischief it can. I attack them as soon as they are hatched, when they are little bigger than small points of white threads on the under sides of the leaves. Formerly, I used to have disputes with my mates about the white threads, which are still denied to be young caterpillars by some very worthy gardeners. I believe Mr. M'Dougal first pointed them out to me, and explained their progress from the egg to the full-grown moth; before that, I used to think they came out of the earth full grown. I would strongly recommend M'Dougal's syringe to all gardeners, as the best instrument for applying lime-water, or, indeed, water of any kind, to the under sides of the leaves of bushes.—*Thomas Simpson. Hillside, near Carlisle, September, 1838.*

M'Dougal's garden syringe has been figured in our sixth volume, but we here repeat the engraving (*fig. 60.*) for the benefit of our present readers. In this figure, *f* is the cylinder or tube, in every respect the same as that of the common syringe, except that the end screws off; *a* is a bent tube, which screws into the straight tube when the water is to be thrown upwards; *b*, the inner side of one of the roses, showing the orifice in the centre, by which the water is drawn in; *c*, the flap valve, which may be made either of leather or metal, and beneath which there is a wire grating to exclude impurities, when the water is being drawn in; *d d*, roses for screwing on to the end either of the bent tube or the straight tube, one of the roses having holes twice the size of the others; *e*, a convex rose, screwed on to the bent tube, with lines, showing the manner in which the convexity spreads the water; *g*, a hollow screw for keeping in the valve and netting on the inside of the rose; *h*, a punch, and *i*, a piece of wire netting, which is sent along with the syringe, to enable every gardener to punch out his own leather valves, and replace the wire netting, should it give way.



*Preservation of Fruit.* — Dr. Loiseleur des Longchamps preserves apples three or four years, and pears more than one year, by enclosing them in an air-tight box, and depositing it in an ice-house. Previously to placing them in the box, each pear is wrapped in five or six thicknesses of absorbent paper, which, in case of decay, prevents one fruit from contaminating another. Burying the box, which may be of zinc or lead, or perhaps an earthenware vessel, 3 or 4 ft. deep in the soil, would answer equally well; and even a cool common cellar might be used for the same purpose. (*Annales d'Hort. de Paris*, vol. xxi. p. 196).

*A Benefit Society for Gardeners.* — I have been requested to write to you on a subject, which may be said to come home to the feelings of every gardener in the United Kingdom. It is on the formation of a Benefit Society on a large scale, exclusively for gardeners, to provide relief in sickness, and provision for old age. When we consider the number, the influence, and the respectability of this class, it may seem surprising, that a society of this description has not been established before. The accidents of human life, the improvidence of some, and the misfortunes of others, would by this means be mitigated. If we compare the gardeners of the present day with those of thirty years back, we find them as much improved as the plants they cultivate. It requires only to establish a benevolent society for their sick and unfortunate brethren, to raise them still higher in the scale of humanity. — *E.S.*

We refer our correspondent to the paragraph in p. 196., where the establishment of a Gardener's Benevolent Association is mentioned, the leading particulars respecting which will be found in our Advertising Sheet; and it may be sufficient to state here, that the secretary is Mr. Bowler, at the Gardener's Gazette Office, and at Mr. Wright's Hotel, Strand. — *Cond.*

*Prevention of Hail Storms.* — M. Arago has proposed a plan for discharging clouds, in cases of storms, of the electric fluid which they contain, and thus preventing the frequent occurrence of hail storms; which, as is well known, are generally produced by two currents of clouds, charged with positive and negative electricity, crossing each other. It consists in an improvement upon Franklin's experiment of the kite, with which he obtained an electric spark from a cloud. M. Arago recommends that a small balloon, properly secured, armed with metallic points, and communicating with the ground by a rope covered with metallic wire, like a harp string, should be kept permanently floating in the air, at a considerable height, over the spot which it is wished to preserve from the effects of lightning or hail; and he expects that by such an apparatus as this a cloud might have its electric contents entirely drawn off, without any damage being caused, or that at least the intensity of a hail storm would be greatly diminished. The experiment is so simple that it is well worthy of a trial. (*Galvani's Messenger*, as quoted in the *Morning Chronicle*, April 12. 1839.)

---

## ART. II. Foreign Notices.

### FRANCE.

*La Greffe herbace*, or herbaceous graft, is commonly thought to have been the invention of the Baron de Tschoudy of Metz, who employed it extensively in grafting the pine and fir tribe; but Francis de Neufchâtel says this graft was known in France in the 16th century. (*Annales de la Société d'Hort.*)

*The Grapes of Fontainebleau and Thomery* are, unquestionably, the best produced in the open air in the neighbourhood of Paris. At Fontainebleau, the vines have been cultivated in the Royal Gardens, as far back as the time of Francis I. They are grown against a wall, above half a mile in length, built in the direction of east and west; about 10 ft. high for three fourths of its length, with the remaining portion in the centre from 18 ft. to 20 ft. high. This wall is covered on the south side with a variety of grape called Chasselas

(our Muscadine), the fruit of which variety is said to be very superior at Fontainebleau and Thomery, to what it is anywhere else. This wall, since the time of Francis I., has been many times repaired, and more than once rebuilt, while the vines have been several times replaced by other plants, the fruit of which is supposed to be of a finer quality. The present manager of this vine wall is M. Brassin; and he told M. Poiteau, that there is but one vine plant against the wall at present, of all those which he found there seventeen years ago, when he was appointed to the situation. Even many of the plants introduced within the last seventeen years have been renewed. M. Brassin does not use dung as manure, but a composition formed of the cleansings of ditches, the surface of pasture land, sweepings of roads, &c., mixed well together, and not made use of till after it has stood two years, and been frequently turned over during that time. When the fruit is full grown, instead of thinning the leaves which shade the fruit from the sun, as is the common practice, which is so injurious that the more the leaves are removed the less the fruit ripens, he takes away the leaves between the grapes and the wall, in order that the heat of the sun may be reflected by the wall on the grapes. M. Poiteau truly observes that no leaves can be safely removed by any one who does not possess some just notions of vegetable physiology. (*Annales de la Société d'Horticulture, &c.*)

#### BELGIUM.

? *Dámmara* sp. — I do not know whether you remember what I said to you one day about *Pinus pinnata*. As I could not find specimens of it anywhere in London, perhaps you will feel interested in the following details respecting what I learnt of it in Flanders. I consider this *Pinus* a *Dámmara* or at least some genus nearly allied to it. There is a specimen of it, which formerly belonged to M. Parmentier, at Enghien, who received the seeds from India. He raised six or eight plants, but there is only one alive at present, which is at M. Makoy's Nursery at Liège. All the others are dead. This specimen is 18 in. high. The leaves are about 1 ft. long, and are composed of from three to four pairs of small leaves, with a terminating one. They are of the same consistency as those of the *Dámmara orientális*, but they are only about half the width, and more than two or three times the length. They are of a very glaucous colour, and the leaves are not stiff, but rather droop. The plant is very delicate, and likes heat. M. Makoy keeps it in a heat of from 12° to 15° Réaumur. These are all the observations I have as yet been able to make on this plant, and it is too small at present to furnish more ample details. At all events, it is not a *Pinus*, but a *Dámmara*, or a new genus. It will form a striking feature in the commerce of plants, and, on account of its rarity, it will be one of the most interesting new plants of the age.—*Fred. E. Wagner. Ghent, April 4. 1839.*

*Ghent Floral Exhibition.* — We have had an exhibition far superior to anything I ever saw; the camellias and azaleas, in particular, and also peonies. There were many thousands of plants, arranged with great taste and judgment. It lasted four days; in the mornings for subscribers, and in the afternoon for the public. The prizes were numerous; medals of gold, silver, and copper.—*R. L. Ghent, April 1. 1839.*

#### HOLLAND.

*Gardens of Balconies, in Rotterdam.* — Lines of houses have been built rising out of the water, the liquid quiescent mass pressing against the brick walls, and within 2 or 3 feet of the lower range of back windows of the dwellings. Frequently, for ornament and use, small wooden balconies, with tidily painted railings, have been projected from the edifices over the water, and on these were placed slips of green turf and boxes of plants, forming a species of shrubbery in miniature. In short, a back green, measuring 12 ft. by 3 ft., and possessing the usual accompaniments of such a valuable domestic convenience. There is not only, however, water in front of the house and behind the house,

but also water within the house. Into tanks or dungeons beneath a considerable number of the best order of habitations, the water of the haven flows through channels made for the purpose, and is, from these dismal reservoirs, pumped up to the kitchens in the higher parts of the dwelling. (*Chambers's Edinburgh Journal*, Oct. 20. 1838.)

#### PORTUGAL.

*The Vine* is trained in Portugal much in the same manner as it is in France ; at least in those districts where it is cultivated for the production of wine. The plants are seldom allowed to grow more than from 3 ft. to 4 ft. high, and they are about the same distance from each other. The soil is stirred once or twice a year ; the young shoots are supported on poles of reed, or trained horizontally upon the tops of the others ; and there is only one pruning given in the course of the year, which is in February, or the beginning of March. In general the vines are allowed to ripen as much fruit as they will carry ; but, in this case, the juice produced is neither rich in flavour nor saccharine in quality, and the wine produced is consequently poor and of little value. In the best vineyards, and especially those in which the Port wine is produced, a plant is seldom allowed to bear to maturity more than three or four bunches of grapes. Hence it is, that the wine produced is so superior to others. (*Marnock's Flor. Mag.*, vol. ii. p. 75.)

#### SWEDEN.

*The old Botanic Garden at Upsal* is situated near the house in which Linnæus lived, and in which he died. The building that it surrounds, which is now the house of the East Gothland Students' Society (*Ostgothischen Studenten-Vereins*), was erected in 1740 for the pursuits of Linnæus ; and here he and Thunberg prosecuted their botanical studies. The gardens and the buildings are both kept in the very best order. Several societies in the country have since laid out gardens, and erected buildings in a similar manner.

Forthcoming generations will revere this garden ; and especially for the trees, now of luxuriant growth, still preserved here, which were planted fifty years ago, under the directions of our valued monitor (Linnæus), and tended by his indefatigable hand. With such recollections and feelings, I visited the two patriarchs of botany, J. and P. Afzelius, with the intention of seeing their gardens. That of Professor John Afzelius is, from a waste piece of ground transformed to a beautiful and fruitful garden ; and contains a considerable collection of rare trees and shrubs in the greatest vigour. Among them I observed, particularly, trees from the southern part of North America, which had attained an unusual height. It will undoubtedly appear remarkable, that, so far north as Upsal, is an *Amelanchier vulgaris*, of sufficient size to induce magpies to build their nests on its branches. Several forest trees, such as the different kinds of ash, birch, chestnut, and maple, grow here vigorously.

The garden of Professor P. Afzelius, although not so abundant in forest trees, contains a much richer collection of rare and ornamental herbaceous plants. Large beds of *Narcissus tazetta* and double tulips occupy the upper terraces ; and among these bulbous plants is seen the white narcissus, which almost always produces two flowers on each stem ; and *Galánthus plicátus*, described and figured in the number 183. of *Loddiges's Botanical Cabinet*, a native of Caucasus, and introduced into Europe by Clusius, which was flowering here in the greatest luxuriance ; *Calámpelis scabra* had ripened seed the previous year in the open air, part of which was kindly presented to us. We also found here a considerable collection of several kinds of aconite, anemone, columbine, fritillaria, gladiolus, lily, &c., all arranged according to their natural orders. (*Garten Zeitung*, Sept. 2. 1837.)

*Death of the Daughter of Linnæus.* — Died at Upsal, on the 21st of March, in the ninetieth year of her age, Miss Louisa von Linné, the only remaining daughter of the great naturalist, Linnæus. She left considerable property, which goes to the two great-grandchildren of Linnæus ; one the widow of M.

Martin, the other the wife of M. Ridderbjelre." (*Hamburger Neue Zeitung*, April 5. 1839.)

#### ICELAND.

*Horticulture about the End of the Eighteenth Century.* —The potato had been cultivated upwards of fifty years, and a "medal of merit" had been bestowed on M. Haldorsen, who introduced it, by the king of Denmark. The culinary vegetables which succeed the best between latitudes 65° and 66° are the following: — Curled German greens, white field cabbage, red field cabbage, turnip-rooted cabbage, savoys, broccoli, and cauliflowers, which, however, seldom get sufficiently advanced before winter to show flower. Turnips, radishes, and horseradish, which grows vigorously. Black mustard, which grows to the height of 10 ft., and is used for covering summer-houses. The onion and the garlick, and also lettuce, parsley, &c., succeed to a certain extent. It is rare, however, that any description of corn ripens; and the poorer part of the inhabitants content themselves with collecting, from the sandy wastes, the under-ground shoots of *Arundo arenaria* L., which they dry, and grind into a sort of meal; though it requires forty horse-loads of the plant to produce 4½ cubic feet of meal. — *Journey of MM. Olafsen and Povelsen in Iceland*, as quoted in *Annales d'Hort. de Paris*, vol. xix. p. 91.

#### INDIA.

*The Botanical Gardens of Calcutta.* —I could wish to furnish your readers, through the medium of your instructive journal, with a brief description of these delightful gardens. They are kept in excellent order. The walks are long and well arranged for promenading in, being shaded on both sides by aspiring and spreading groups of palms, cedars, banyans, bignonias, mangoes, and other Oriental timber. The flowers, profusely disposed in all directions, seem to vie with each other in beauty and variety, whilst the groves of orange, citron, and lemon trees, when in full blossom, impart an odour of fragrant richness to the surrounding atmosphere. The varied family of the spice shrubs, comprehending the cinnamon, clove, nutmeg, and "cajeputah," combine to aromatise the air, and numerous "*Tróchili*" (hummingbirds), some of them as minute as butterflies, arrayed in iridescent plumage, are to be seen hovering over the sunny smiles of the opening flowers; the dark groves, all the while, breathing forth sweet and welcome music from the feathered songsters, which, concealed in their shady retreats, "while away the livelong day," in vocal revelry. Here and there, buried amid the luxuriant foliage of aloes and cactuses, is to be detected a grotesque cool-looking villa, the residence of some one of the curators or superintendents of these extensive and interesting grounds, which gentlemen are at all times agreeably disposed to accompany visitors around the premises, and to point out to them the more rare and choice productions, which help to constitute this botanical conservatory. At the extremities of the walks are erected elegant temples, in some of which are carefully situated the busts of those who, in their day, have contributed their means, time, and attention towards improving this horticultural establishment. This Elysium (for such a classic appellation is by no means inappropriate to it) is intersected by four streams, over which are thrown several elegantly constructed bridges on a modern principle. On the banks, bowers and grottoes have been tastefully disposed, mantled with creepers, which, encircling the giant boughs of the lofty trees that impend over them, are encumbered with fairy flowers of every hue, whilst here and there the visitor, amid a wilderness of cinnamon trees, steals a glimpse of the river Hoogly, with its little skiffs flitting with their butterfly sails up and down the stream, his ears catching at intervals the distant song of the merry boatmen, as their paddles sport uniformly upon the spangled wave. These gardens have for some years past been under the immediate superintendence of Doctor Wallich, who has spent much of his time in bringing his charge to the state of perfection at which these grounds have at length arrived. In his arduous



travels through the Nepal country he alighted upon and collected a great variety of plants and seeds, which were not before known to have been indigenous to the climate of India. He, among other valuable exotics, discovered the gentian shrub in Nepal; and it is mainly to this gentleman and to Captain Jenkins, we are indebted for the valuable discovery of the tea plant in Assam. What adds greatly to improve the scenery of the gardens is that goodly edifice, Bishop's College, which stands at the extremity of the northern terminus of the long avenue. It fronts the river, on a green plot of ground, and assumes a commanding feature from the Hoogly. This college is built in the Gothic style. The library is composed of one room, about 65 ft. in length, and is well stocked in ancient and modern literature. The classification of the works is admirably well arranged. The chapel is particularly neat, and modelled after the collegiate style. On the left side of the altar is erected a well-designed marble tablet to the memory of the late Dr. Fanshaw Middleton, the first prelate of Calcutta, during whose episcopacy the foundation-stone of Bishop's College was laid, under the auspices of the Incorporated Society for the Propagation of the Gospel in Foreign Parts. The hall is spacious and airy, and at the south end is a very fine painting, a faithful portrait of the late Bishop Heber in his episcopal robes, which was executed by Chinnery. This building reflects much credit on the architect. I spent two months at this college in the spring of the year, and I am ready to confess that the great pleasure I derived from my visit, during the comparatively short time I tarried there, was such as, had I had no other object in view, would have doubly repaid me for a voyage made out to India and back again. — *Orientalis.* *March* 13. 1839. (*Morning Herald*, April 5. 1839.)

---

### ART. III. *Domestic Notices.*

#### ENGLAND.

*BOTANIC Garden, Bury St. Edmunds.* — William Borrer, Esq., F.L.S., &c., of Henfield, near Brighton, has presented to our Botanic Garden a fine collection of willows (*Sálices*), containing 130 varieties and species, both rare and interesting. A more favourable spot for a salicetum, or willow walk, than the banks of the river Lark, in the Abbey grounds, could not be selected; and the facility by which it can be effected may probably lead to more extensive cultivation of the genus by many of the patrons and subscribers to the garden. (*Bury Post*, Feb. 1839.)

*The Highgate Horticultural Society* has just been instituted under the auspices of a committee of ten respectable gentlemen resident in Highgate or its neighbourhood. The honorary secretary is H. Tatham, Esq., of North Road, Highgate. — *B.*

*Hot-water Apparatus at Capheaton.* — The success of the hot-water apparatus was fairly tested last winter in my garden. Two stoves of 80 ft. by 18 ft. each, heated by one boiler, and the fires not meddled with from eight at night till seven next morning, did not vary, during that period, above four or five degrees, and of course no plants were injured. I have a peach-house, three vineries of 30 ft. each, and a fig-house of 20 ft. (figs will not ripen here but under glass), all heated with one boiler and one fire, and yet so contrived that I can warm each house separately. Fuel is no object here, but the saving of labour is very great. The two fire-places and two chimneys I have just mentioned, which perform the work I have stated, are substituted for fourteen fires; when the houses were flued, it was one man's sole work to look after the fires in spring. All smoke, dust, &c., are avoided in the houses, and the external smoke is nothing now, and no sweeping and taking up flue covers. — *John E. Swinburne.* *Capheaton*, December 1. 1838.

*Hoitza mexicana* is a splendid plant, belonging to the order Scrophularineæ, with an upright habit like *Leonurus*, and other suffruticose plants of the same order. It requires the protection of a green-house during winter; but is as admirably adapted for the flower-garden during summer, as larger *salvias* and the *fuchsias*. It first flowered in 1838, in the collection of James Harris, Esq., at Kingsbury, where there is now (January, 1839) a plant upwards of 6 ft. high, covered with its fine pink blossoms. It ought to be in every flower-garden during summer. — *S. T. Jan.* 1839.

*Paxtonia rosea* Lindl. — In speaking of this plant in the *Floricultural Magazine*, Mr. Marnock, the editor, has the following judicious remarks. We entirely concur in them, not only from our personal knowledge of the circumstances mentioned, but because the Duke of Devonshire has stated to us, himself, that he owed his taste for botany and gardening entirely to Mr. Paxton. "There are but few persons in the present day, whose talents and exertions have conferred more service on the science of botany and gardening, than the gentleman to whom the above compliment has been paid. A few years have only transpired since Chatsworth, so far as gardening was concerned, was below mediocrity, and its noble owner bestowed neither money nor patronage in advancing the art; in fact, he had no taste for gardening; but now he is its best and most influential friend. To promote the objects of gardening and floriculture, large sums are now being expended, and his patronage and influence is rapidly extending itself in the higher walks of society. Thus, now the soothing and peaceful pursuits of floriculture present attractions, which have been embraced by not a few of even those whose interest and attention could seldom be engaged, except in favour of the barbarous and exciting amusements of the race course, or some pursuit equally doubtful in its moral tendency. By our judicious and prudent friend, His Grace has been led on by gradual advances, and is now enthusiastically fond of plants. As proof of this, the largest tropical conservatory in Europe is in course of erection at his princely demesne, Chatsworth; and Mr. Paxton is now enjoying a three months' tour on the Continent, in company with his noble employer, for the purpose of adding additional attractions to his botanical establishment at home. The example and influence of His Grace must be felt, especially in the higher circles, and who dare say that they need no improvement. The effect resulting from this influence is unquestionably due to Mr. Paxton, who is thus, no doubt, the unconscious author of an amazing amount of good." (*Marnock's Flor. Mag.*, vol. iii. p. 161.)

*Melilotus? arborea* Castagne. — A gentleman from Bokhara has brought with him some seeds of what he calls Bokhara clover; which, he says, in its native country, grows to the height of 15 ft., and can be cut four times a year. When not wanted as fodder for cattle, and allowed to attain its full growth, the fibres of the bark are said to make a substitute for hemp. From the seeds, this clover appears to be a *Melilotus*, probably *M. arborea*, which was introduced into England in 1826, and perhaps subsequently lost. A few seeds have been left with us, which we have distributed among our correspondents, who will doubtless favour us with some account of the growth of the plant at the end of the year, and again at the end of the second year. We do not expect that live stock will eat any *Melilotus* with the same avidity as they do common clover; but if *M. arborea* grows 3 or 4 feet high in Britain, it may be a useful addition to our herbage plants. Bokhara, as our readers know, is a country of Central Asia, between 36° and 42° of north latitude, and 63° and 70° of east longitude. The surface of the country is even, and not above 500 or 600 feet above the level of the Black Sea, but it is surrounded by high mountain ranges. The climate is regular and constant, and so warm that melons and grapes arrive at perfection in the open air. There are no natural pastures, but trefoil and other herbage plants are cultivated as substitutes. The coldest month is January; in which the thermometer falls to 27°, and sometimes to 6° Fahr., and occasionally the snow covers the ground for a fortnight. The summer commences with March and lasts till October, during

which period it does not rain ; but the thermometer rises to 90°, and even to 100°. By comparing these facts with analogous ones relative to Britain, the cultivator will be able to form some idea of what he is to expect from the Bokhara clover in this country. We may here observe that we had nothing to do with a paragraph respecting this clover, in which our name is introduced, and which has appeared in several newspapers. See our letter to the *Globe* newspaper on the subject. — *Cond.*

*Cannabis sativa* var. *gigantæa*. — This is a variety of the common hemp, which, in deep rich soil, in the neighbourhood of Vienna, attains the height of 20 ft. in the course of the summer. This our assistant, M. Francis Rauch, states to be a fact ; but he adds that the plant is never made any use of as hemp. We have distributed a few seeds of it. — *Id.*

*Linum usitatissimum* var. *gigantæum*. — This is a Siberian variety of the common flax, which is said to grow to a great height. A few seeds were left with us by Dr. Fränkel, which we have distributed. — *Id.*

*New Herbage Plants.* — As the tendency of agricultural improvement in every country seems to be to stall-feeding, or, rather, to feeding in court-yards with sheds, instead of pasturing in fields, every attempt to make an addition to, or an improvement on, our herbage plants ought to be encouraged. Our idea is, that the time is not far distant when, in the best cultivated districts of Britain, the only animals pastured in the fields will be sheep ; and that these will be folded on portions of verdant surface not larger than they can crop in a day or two, when they will be moved to a fresh portion. Hurdles or net-fencing will be used as substitutes for permanent fences ; and then, of course, hedges and walls will no longer be wanted on most farms, except for an enclosure or two adjoining the farmyard. This will be a saving of the ground occupied by the fences, of their first cost, and of their annual keeping ; while it will, at the same time, destroy the source whence are dispersed innumerable insects and seeds of weeds. In hilly countries, and in valleys, which can be more profitably kept under perpetual grass than under the alternate system of herbage plants and corn, we do not say that fences will not continue to exist ; but we have no doubt whatever of their sooner or later disappearing from all countries which can be subjected to the alternate husbandry ; and more particularly where such countries have long dry summers, as is the case in most parts of the Continent. On the greater part of the Continent, indeed, there is no way of procuring manure sufficient for farming to advantage, but by consuming the herbage crops under cover, and saving and fermenting all the liquid matters produced in the farmyard and in the offices of the house. In this view of things, it will readily be conceived that we attach great importance to the improvement of old, or the introduction of new, herbage plants ; and more especially of those tap-rooted or deep-rooting kinds which are adapted for countries having long dry summers. We have great pleasure, therefore, in introducing the following extract from the letter of an enlightened and scientific correspondent : — “ I have four or five species of *Heraclæum* in cultivation, of the value of which I entertain great hopes, and some new grasses ; one from Siberia, *Alopecurus nigricans*, seems to be valuable for its bulk and earliness, beyond most *Graminææ* which we have hitherto had in cultivation. I think, too, that among several species of *Sónchus* and *Hieracium*, which I am now trying, there are several which will be useful fodder plants on light siliceous soils ; of which, at a future time, when I see more about them, I may perhaps trouble you with an account.” — *W. P. T. April 4. 1839.* Any of our readers who have seeds of new herbage plants, or of plants which they think might prove useful as such, will greatly oblige us by sending a few, in order that we may forward them to our esteemed correspondent, *W. P. T.* — *Cond.*

#### SCOTLAND.

*Agricultural Implements sent to England.* — The Messrs. Drummond, of the Agricultural Museum here, have, within these few weeks, been intrusted with the execution of an order for ploughmen, horses, implements, seeds, &c.,

intended for an experimental farm in Gloucestershire; where, we understand, every thing is to be conducted with a strict adherence to the Scottish system of husbandry.

Besides many other articles of minor import, the commission included four ploughmen, nine horses, six carts, eight sets of cart and plough harness (common), Smith's subsoil and green-crop ploughs, harrows, draining-implements, sowing-machines, Drummond's reaping-scythes, &c.

From what we have heard from judges, the various specimens are such as to do no discredit to the spirited establishment from which they have issued. A notion appears to be prevalent that the horses might have been heavier, but it seems ordinary farm horses were wanted. We consider such an outfit as an honour conferred on the district, in as far as its practical farming and manufacture of agricultural implements are concerned; and while we hope the whole may reach the place of destination in safety, we wish every success to the truly patriotic object.

This important commission having been completed, the ploughmen, with their charge, under the superintendence of a young gentleman from England, set out in travelling order for Carlisle, Manchester, and Warrington, and expect to perform the journey, which is nearly 400 miles, in about twenty days. (*Stirling Advertiser*, March, 1839.)

---

#### ART. IV. *Retrospective Criticism.*

*THE Horticultural Society.* — [Since the publication of our paragraph on this Society in our March Number, p. 145., we have received three letters, from the last of which we make the following extract, because it principally concerns ourselves.]

"You and many others strongly advocated a paid secretary this time nine years, and I think you have by this time been pretty well served by your favourite idol. I have neither time nor inclination now to look over documents in my possession; but I well recollect that you, *in particular*, strongly recommended Dr. Lindley as the fittest person to conduct the affairs of the Society, as a paid secretary; and, of course, you are of this opinion still, when you could *satisfy your conscience* by what you said of those who have the management of the Society's affairs, in the *Gardener's Magazine* for March, p. 145. A large share of the credit or discredit of the management or mismanagement of what has been done or undone for the Horticultural Society since 1830 lies at your door. There now exists a strong feeling against the proceedings of the Society in the minds of many influential persons, and I make no doubt but their whole proceedings must come to a crash. — *S. April 6. 1839.* It does not follow that because we entertained a certain opinion at a certain time we are bound never to change it. In the present case, however, we see no reason for doing so. We still think a paid secretary the best; as, if such a secretary does not do his duty, the remedy is in the hands of the council. — *Cond.*

† *The Analogy between Plants and Animals.* (Vol. XIV. p. 411.) — *Errata.* Page 413., fourth line from the bottom, for "the collar," read "the root"; p. 415., what is said respecting slow and quick grown timber is right in the case of the Coniferæ, but the reverse as regards oak and other deciduous trees; p. 417., second line from the top, after the words "most part," add "like some animals;" and, ninth line from the top, after the words "of the same," add "or nearly allied." — *J. M. March, 1839.*

*Erratum.* — In p. 193., bottom line, for "in flower at Natale," read "in flower at Christmas."

ART. V. *Queries and Answers.*

*FITZWALTERS* known also by the name of the Round House, was situated opposite the nine-mile stone on the London road, in the parish of Shinfield. In 1301 the estate was the property of Robert Earl of Fitzwalter. The mansion, now destroyed, was built by Mr. John Morecroft, in the 17th century, after an Italian model, and was an object of general observation and curiosity, being of an octagon form. Notwithstanding this singular shape each floor contained four square rooms; the centre of the house was occupied by the chimnies; and staircases filled up two of the intervening spaces between the square rooms, while the remainder formed small triangular apartments, devoted to dressing-rooms, closets, &c. The interior was built chiefly of timber, the girders being of very large dimensions. Fitzwalters was many years the property and country residence of Mr. T. Wright, the banker, of Henrietta Street, of whose representatives the late Mr. Hall, grandfather of the present possessor, purchased the property. (*Chelmsford Chronicle*, as quoted in the *Times*, March 30. 1839.)

I should be greatly obliged to you, or to any of your readers, for a reference to any source from which I could procure plans, elevations, and sections of the above-named mansion; a friend in North America having it in contemplation to erect something of the kind in a very elevated site.—*T. S.W. London, April, 1839.*

*Kölreuteria paniculata* and *Liriodendron Tulipifera* are said not to be attacked by insects in this country, and the reason assigned is, "the absence of the insects which prey upon them in their native countries." I find this statement made by Dr. Robert Dickson, F.L.S., in a series of papers written by him in the *Church of England Magazine*, entitled *Natural Theology of the Vegetable Kingdom*, and they occur in the third volume. Not having been aware of the above facts with respect to the two trees named, I shall be glad to know how far the experience of others of your correspondents agrees with the statement. It would also be interesting to be informed whether Dr. Dickson has made the statement on his own authority, or whether he can give chapter and verse for it.—*Clericus. London, Dec. 1838.*

*Grevillea rosmarinifolia*.—In Paxton's *Magazine of Botany*, vol. iv. p. 47., published in 1837, it is stated, that *Grevillea rosmarinifolia* has been found to be completely hardy in the Epsom Nursery. Has it stood the winter of 1837-8?—*J. A. B. January, 1839.*

*The Leek Gros-Court* is said to be a monstrous variety of leek, cultivated by M. Duvillers in the neighbourhood of Paris. It seems to be a perennial, because, when cut over, it soon springs up again. It is said to be found also at Rouen, where it produces stems 13 in. in circumference. Its duration is said to be only three years. It ripens seeds, which reproduce the same variety. M. L. La Croix, a partner in the house of M. Vilmorin & Co., says, it is almost the only leek cultivated at Rouen, and also that it is cultivated in England, under the name of the London Flag. We should be glad to know something more about it, not only for the sake of our readers, but because the leek is a very favourite vegetable of ours, especially when grown to a large size.—*Cond.*

---

ART. VI. *Foreign Botanical and Horticultural Agency, by William Pamplin, Jun.*

"THE death of Mr. Hunneman, who has for a great number of years transacted, in the most prompt and liberal manner, the business concerns connected with the purchase and transmission of books and parcels of so large a portion of naturalists both of this country and the Continent, will be long and severely felt. But it is with great pleasure we can announce that Mr. Wm. Pamplin, jun., botanical bookseller, of Wandsworth Road, London, and

now also of 9. Queen Street, Soho, has succeeded Mr. Hunneman in this department. We have the pleasure to know Mr. Pamplin personally, and are well acquainted with his punctual business habits, his great steadiness of character, his obliging manners, and his ardent attachment to natural history in general, and to botany in particular; and we can with confidence recommend him as a worthy successor to our lamented friend. We have reason to believe that circulars, containing further particulars, will at once be issued by Mr. Pamplin; and we know that he will have the advice and assistance of Mr. Hunneman's family in the first outset of his transactions.—*W. J. H. (Annals of Natural History, No. xv. p. 143.)* To the above testimony of Sir William Jackson Hooker, we can add our own, having known Mr. Pamplin for above a dozen years, and had many transactions with him in the way of procuring or exchanging scarce horticultural books, and invariably with the utmost satisfaction. It will be of immense advantage to literary botanists and horticulturists, if Mr. Pamplin should add to the kind of agency in which the late Mr. Hunneman was engaged, that of importing foreign botanical and horticultural works.—*Cond.*

---

#### ART. VII. Obituary.

*M. TRIPET*, a celebrated tulip-grower of Paris, died in that city on April 8. 1837, in his 55th year. The taste for flowers, and particularly for tulips, may be said to have been hereditary in Tripet's family. Grandfather, father, and son have been celebrated in this way for more than a century. The grandfather was a native of Champagne, possessing but little wealth, but he was fortunate enough to marry a lady of rank in that province, a circumstance which rarely occurred in those days. His son was born in 1749, and his tulip shows, in the Champ Elysées, were celebrated throughout the kingdom. At the revolution in 1789, M. Tripet emigrated to England, where he remained nearly ten years; and soon after his return to France in 1799, he exhibited his collection to the public in his garden, in the Rue Fauxbourg St. Martin. In 1801, he removed to the Champs Elysées, where his garden was visited by all the eminent persons in France, including the ambassadors from foreign powers. In 1814 he was appointed florist to the emperor, and daily sent bouquets to the apartments of the palace, and planted yearly two beds of tulips in the gardens of the Tuileries. This M. Tripet the second had a son equally attached to flowers with the father, and who assisted in the management of his concerns; but he died before his father. M. Tripet's successor is M. Le Blanc, whose establishment for the sale of bulbs and flower seeds is on the Boulevard des Capucins, and whose nurseries are at Maisons-Alfort, and at the Avenue de Briteuil. (*L. L. and Annales, &c., for 1837.*)

*Dr. F. Falderman, C.M.H.S.*, curator of the Botanic Garden, Petersburg, author of *Fauna Entomologica Trans-Caucasica*, 3 vols. 4to, and of various articles in this Magazine, died in the beginning of the present year; the precise time we have been unable to ascertain. Some of our readers will recollect the list of melon seeds given in Vol. VI. p. 339., which we received from him and distributed; and also the list of rare plants sent from Persia to the Petersburg Botanic Garden, in the same volume, p. 321. The last letter which we had from Dr. Falderman was dated October 24. 1838, in which he says that the third volume of the *Fauna Entomologica, &c.*, is in the press, and will be finished before the new year. Dr. Falderman was a scientific botanist and horticulturist; and well acquainted with British practices, having been some time in the Horticultural Society's Garden, as well as in those of his native country (Germany). He was much respected at Petersburg by all who knew him.—*Cond.*

---

THE  
GARDENER'S MAGAZINE,  
JUNE, 1839.

---

ORIGINAL COMMUNICATIONS.

ART. I. *Design for the Leeds Zoological and Botanical Gardens, approved of by the Provisional Committee, and proposed to be erected when a sufficient Sum has been subscribed.* By WILLIAM BILLINGTON, Civil Engineer and Architect, assisted in the Ground Work by EDWARD DAVIS, Botanist and Landscape-Gardener. Communicated to the "Gardener's Magazine" by JOSHUA MAJOR, Landscape-Gardener, Knowstrop, near Leeds.

YOU state (Vol. XIV. p. 194.) that you have neither seen nor heard any thing of the plans which were offered in competition for the Leeds Zoological and Botanical Gardens, with the exception of one by Mr. Pringle (given in the same volume, p. 248.). It was my intention to send you a copy of the successful plan, immediately after the competition plans were exhibited; but it was some time before I could procure one; and since then business has prevented my doing so. However, I now send you a lithographic copy of the plan (see *fig.* 61.); but how far its arrangements may be adhered to I cannot tell, as I have not seen the gardens since the commencement of the works.

I was frequently solicited by some of the gentlemen connected with the Society, to compete for the premiums offered for the best plans, and having myself, at the first outset, fixed on the site for the gardens, and given my opinion as to its eligibility, I naturally felt a wish to do all that I could to promote an object so desirable; consequently, I sent the plan I now hand to you (see *fig.* 69.), with an understanding that it should not be put in competition for the premium offered; as plans are frequently submitted by men inexperienced in the art of laying out grounds, and which have an equal chance with those submitted by professional men, when they are left to the decision of incompetent judges. My plan may be considered incomplete, inasmuch as I have not shown elevations of the buildings proposed to be erected, and in its not being more explicit in the botanical arrangements; but time would not then permit my going more into detail; and, considering the general disposition of the plan as being of the most importance at first, I let that suffice, with the exception of explanatory observations. It is only a few weeks since I received back the plan (in a tattered condition), the coun-

cil having had it in their possession four months, although repeated applications were made for it. I also sent with the plan a criticism on the plan approved by the council, headed by an introductory letter; and, although I have reason to believe advantage has been taken of the suggestions there given, I have not so much as received a reply to my letter. To me this appears very strange, being, for any thing I know, on friendly terms with all the gentlemen forming the council; and what I have done having been gratuitous, and with a view to benefit the institution.

The site fixed on for these gardens offers a capability, I believe, of their being formed equal to any yet in England; and, therefore, the best advice ought to have been obtained.

*Knowstrop, near Leeds, Nov. 2. 1838.*

---

ART. II. *Remarks on Mr. Billington's Plan for the Leeds Zoological and Botanical Gardens, in a Letter to the Council.* By JOSHUA MAJOR, Landscape-Gardener.

“GENTLEMEN,

“I had the privilege, a few days ago, of looking over the engraved plan (*fig. 61.*) adopted by you for laying out the intended Leeds Zoological and Botanical Gardens; and, having given this design a careful perusal, I beg to hand you my observations respecting it. Having myself so long been an advocate for providing Leeds with public pleasure-gardens, this will be a sufficient excuse for the liberty I have taken; and the more so, as I consider the situation fixed on as admitting of gardens being formed in it superior to any public garden yet seen in England. Add to this, that I consider the plan before me as very defective in its arrangements, and ill calculated to effect the object in view, and hence I feel it my duty to endeavour to point out the errors which I think it contains. I have sent the plan (*fig. 69.*) which I left for your inspection some time ago (for laying out the Leeds Gardens), as, perhaps, by referring to it, some of my observations will be better understood.

“I am, Gentlemen, your obedient servant,

“*Knosthorpe, Feb. 9. 1838.*

JOSHUA MAJOR.”

---

*References to fig. 61.*

*Mr. Billington's Design for the Leeds Zoological and Botanical Gardens.*

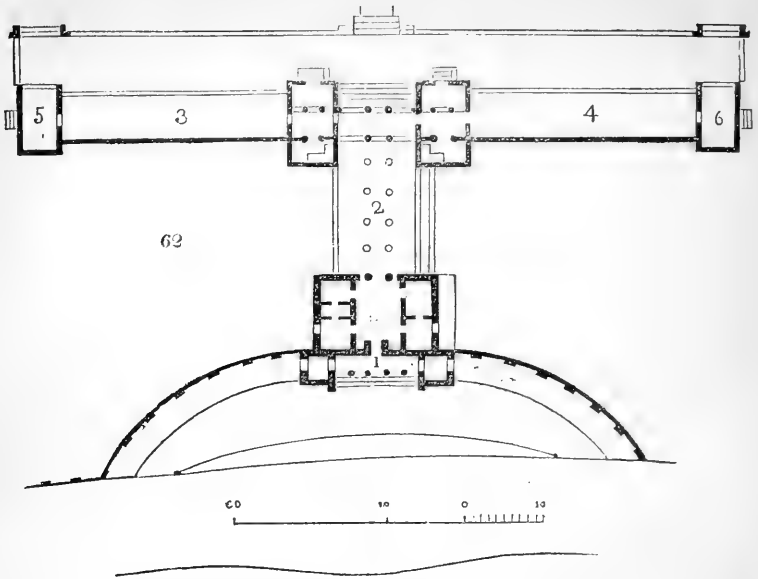
- |  |                    |                                      |
|--|--------------------|--------------------------------------|
| 1, Principal entrance from Leeds.  | 2, Orangery, &c.   | 3, 4, Green-houses.                  |
| 5, 6, Conservatories.  | 7, Large fountain. | 8, Large conservatory for palms, &c. |
| 9, 10, Structure appropriated to plants of temperate climates, with birds intermixed, and to be enclosed with moveable sashes if required. |                    |                                      |
| 11, 12, Conservatories appropriated to tropical fruiting plants.   |                    |                                      |
| 13, Zoological department appropriated to zoological specimens.  |                    |                                      |
| 14, Lake with island and rustic bridge   | 15, Rosary.        |                                      |
| 16, Herbaceous plants, arranged according to the natural system.   |                    |                                      |
| 17, Lake with islands for waterfowl, with a fountain on the largest one.   |                    |                                      |
| 18, Entrance lodge from Burley.  |                    |                                      |

*Note.* The plants forming the arboretum are to be distributed according to their genera, as arranged by Linnæus.





61

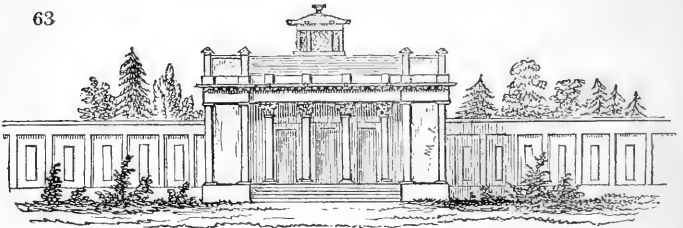


*Ground Plan of the principal Entrance from Leeds, on an enlarged Scale.*

1, Entrance Portico.      2, Orangery.      3, 4, Green-houses.      5, 6, Conservatories.

I consider that the approach from the Otley road to the gardens would produce a much better effect, were it either straight or in one gentle curve than as it at present appears in

63



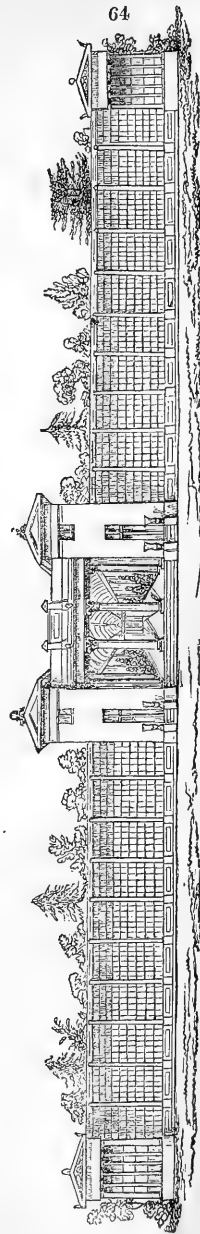
*Elevation of the principal Entrance from Leeds.*

the plan; and the entrance lodge, which I think chaste and pretty, ought to be so placed as to be approached in the most direct manner, and so as to be distinctly viewed at some distance from the above road; but, as it is proposed in the plan, the entrance could only be very imperfectly seen until near to it; and its importance would become much lessened by the indirect and unmeaning zigzag manner by which it is approached.

The site for the stoves I consider bad, inasmuch as it does not afford sufficient space for the intended building, and at the same time admit of plantations and lawns at each end, which are

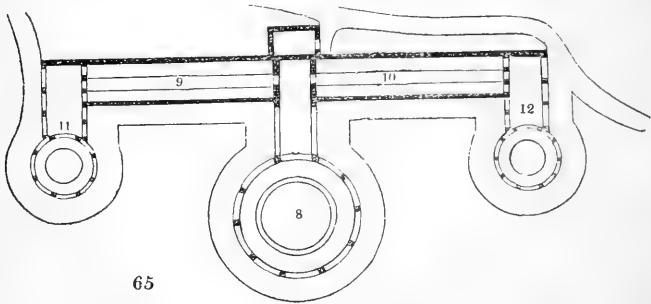
essential, not only to make a finish to the houses and conceal the boundary wall; but also that suspicion may not arise as to there being a want of extent. Indeed, the conservatory on the south-west end of the range, according to the plan, is so placed as to leave not more than three yards betwixt it and the boundary wall; and, if we allow the latter to be 9 or 10 feet high, it must completely shut out the greater part of the afternoon sun from the conservatory nearest to it; and it would be miserable indeed, to have the terrace-walk terminating against an ugly high wall, as represented in the plan. In this range the two end conservatories are too insignificant; instead of being, at least, 8 yards wide, according to the scale they are only 5 yards wide outside, which is less than any moderate-sized private green-house. The two stoves may be useful, but cannot possibly be ornamental, with a sloping roof perhaps 20 ft. or more in length, and with an elevation of only about 4 ft., appearing like fruit forcing-houses, much more suitable for a kitchen-garden, than a pleasure or public garden. Had an elevation something similar to the plant-houses in Sheffield Gardens been proposed in lieu, they would have appeared much more characteristic, and been equally useful. Indeed, I should recommend that none of the plant-houses should have elevations less than 12 ft., and that the whole of the houses have curvilinear span roofs of glass.

If much sun is required for the growth of oranges, which, undoubtedly, is the case, I should say the site proposed is a very unsuitable one, as the buildings in front will shut out the sun nearly the whole of the day, especially in the winter months when its whole power is most wanted; and, indeed, some parts of the house cannot possibly receive its benefits either in summer or winter.



*Elevation of the Orangeries, Green-house & s, Museums, &c. (marked 3, 4, 5, 6, in the plans figs. 1 and 2.), from the Garden Front.*

The elevation of the large conservatory has rather an imposing effect: but, when we consider what it would be when erected, we find it very defective. In the first place, the site is very bad, being fixed in the highest and most exposed situation in the whole ground, and so as to face a few degrees more west than south, a point from which we have the most prevalent high winds, and this without the least shelter, no provision being made for it in the plan. We infer from the ground plan, that the two end conservatories project from the general or straight range of houses about 13 yards, and the centre conservatory about 23 yards. Now, these appendages, with their



65

*Ground Plan of the Conservatories appropriated to Birds and Tropical fruiting Plants.*

8, Large conservatory for palms, &c.

9, 10, Conservatories appropriated to the plants of temperate climates, with birds intermixed, and and to be enclosed with movable sashes if required.

11, 12, Conservatories appropriated to tropical fruiting plants.

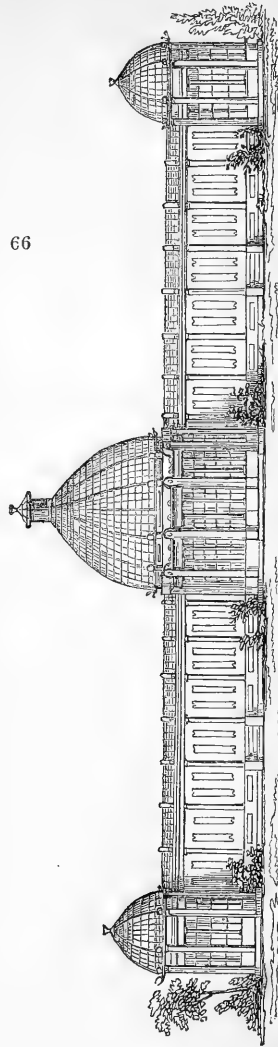
lofty domes, must appear prodigiously heavy, and overbalancing what ought to be the principal range, and of which, they ought only to form parts, instead of which we have here, if I may so speak, all parts, and no principal. Now, were the three conservatories placed in the range, so as to stand in advance on both sides, in equal proportion to what the diameter is more in breadth than the width of the straight range, the whole would appear, I think, architectural and pleasing.

In speaking of the plan of these structures with reference to its utility, we find it not less faulty; for, owing to the centre and two ends projecting out so much (13 and 23 yards), together with their great height, the sun's rays must undoubtedly be kept off from the long range of houses between the domes the greatest part of the day, which is quite contrary to the general rule of obtaining all the sun possible, in order that the plants in the winter months may receive its benefits.

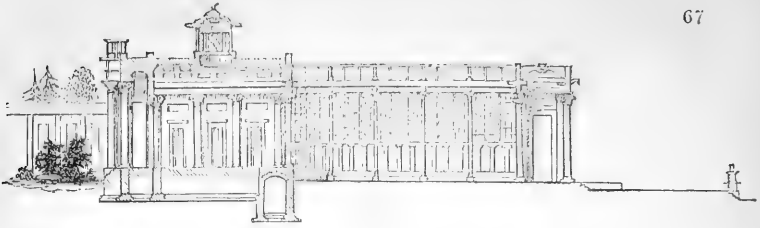
I shall next point out a few of the principal defects in the plan for laying out the grounds, leaving the minor parts unnoticed, for these would be readier explained by comparing the plan *fig. 69.* with the one I am now criticising (*fig. 61.*). In the

arrangement of the walks, we find them too numerous, and all of one breadth, each, apparently, of the same importance, branching in different directions from the entrance, and leaving it very uncertain to a stranger what course to take. It is of the utmost importance, that there should be one principal or main walk leading through or round the grounds, so as to allow the visitor a general inspection, and a ready access to the principal objects. From these main walks, smaller walks of half their breadth should branch at right angles, leading to different compartments, or to display different scenes: thus the visitor could not readily mistake his way; his mind would be free, and at liberty to inspect material objects, and pass through the grounds in the most direct manner, and only turn on these episodal walks when he wishes to view different scenes in detail. [See Vol. XI. p. 649. and 656.] The walks are also defective in not being graceful in their curves, and in there being more than one bend seen at one time, which ought by no means to be allowed. There is a great defect, also, in there being no direct approach to the large or principal range of plant-houses, which ought to be arranged in such a manner as to allow the visitor to view the whole to the best advantage; instead of which, he is led on the east side of the houses, by a circuitous walk, to a considerable distance past them, and at length he is brought, as it were by design, to view them in the worst position possible, viz. the east wing and back wall perspectively, which is barbarous in the extreme; and, if he has no wish to enter the buildings, but proceeds immediately to the entrance gates, the only course provided for him is that lengthened and unmeaning walk, guided by the zigzag line of building, which is much more calculated to offend and perplex the mind, than to afford convenience and pleasure. The

66



*Elevation of the Conservatory for Palms, and of those for Plants of Temperate Climates and Tropical Fruits.*

*Section through the Entrance and Orangery, &c.*

walk which appears round the pond is bad, inasmuch as it betrays the whole of its extent. The large pond in the centre of the garden, I think very tastefully varied in its margin, but not sufficiently long for its breadth. The two bridges crossing it near together, both seen from one point of view, and at the same time appearing of no other use than to approach the island, which is too trifling in extent, can scarcely be in accordance with true taste. But what I consider the most unnatural of all is the site chosen for this pond. The hand of taste could never be so far misled, as to direct that ponds and lakes should be formed on high ground, when at the same time low and more appropriate situations present themselves in the landscape. In this case, the spectator, standing in any position on the high ground, cannot fail to detect an error so barbarous. Moreover, we infer from the plan, that nearly the whole breadth of the pond will have to be formed on the north-east side of the well, in which direction the ground rises considerably, consequently the excavation that will be required, together with the embankment necessary to form a bed for the water, will materially lessen the importance of that beautiful rising ground now existing on each side of the well, and destroy that variety of surface, which every one of true taste would seek to preserve. Indeed, it should be the artist's aim, in these grounds, to increase undulated surface as much as possible.

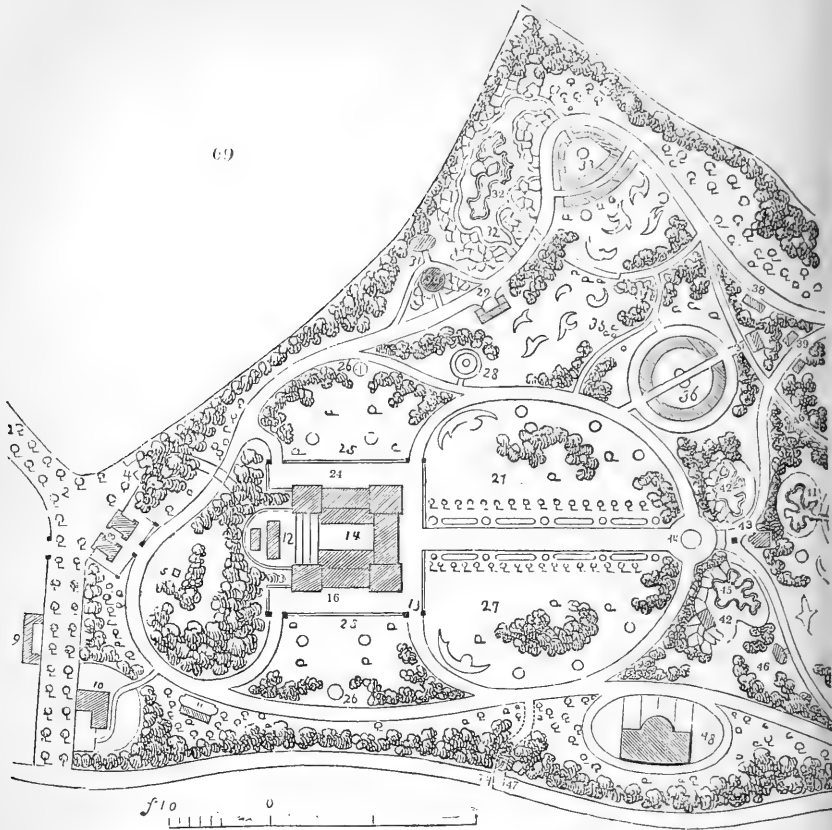
*Elevation of Entrance Lodge from Burley.*

In the arrangement of the planting, two very important defects present themselves. In the first place, shelter has scarcely been a consideration, as there are many breaks, and some to a considerable extent, in the boundary plantation, without a tree; there is also a want of shelter on the high and bleak ground about the plant-houses. Shelter in these grounds certainly is of the utmost importance, not only to afford comfort to the visitors, but, also, because tender plants, and many animals, require all the protection possible from the strong cutting winds. In the

second place, little or no attention has been paid to planting out the boundary wall, which ought to be so screened as in no case whatever to be detected by the visitor. The effect of grouping throughout the ground is generally well managed, as far as the beauty of the plan goes; but, as the natural and broken form of these groups (which are only imaginary) could not possibly be realised without many years' growth, and also can only be effected by allowing the shrubs and trees naturally to break the lines of the beds, or dug compartments, in which they are first planted; and as the beds would be generally under notice, and form principal features in the ground for many years, some having always to retain their form, it is of the utmost consequence that the shape of these beds, or dug compartments, should be of the most beautiful and graceful forms possible; therefore not one step towards planting ought to be taken until a satisfactory plan is given, showing the form or shape of every part to be planted.

There appears to be no specific arrangement made for the arboretum, more than that it is stated to be formed in groups over the ground, according to the Linnæan system. Now, I think it impossible, amongst such a multiplicity of walks and scattered groups of trees and shrubs, to pursue the plants in regular order, without its proving too intricate and perplexing to afford that interest and pleasure to the spectator it would otherwise do, if properly arranged; and, further, there would be a danger eventually of some of the large-growing trees becoming too bulky, and thus overshadowing some interesting spot or important object, which object could not be relieved without taking down a tree or trees; and, in doing this, of course, such specimens would afterwards be wanting to the arboretum. The arboretum ought to be looked to as one grand feature in these grounds, and the site here offers an opportunity of one being formed to equal, nay, I may say, to surpass, any other public arboretum in England. The course I should take would be, to commence at one of the entrances to the gardens, and range skirting under the boundary wall screen all round the garden, until it meets the entrance from which it started. This I should arrange on lawn between the boundary plantation and the principal walk, forming groups of each family in the gardenesque manner, dividing them by broad spaces of lawn, and placing all the dwarf shrubs nearest the walk; and thus the stranger could not fail to command a ready view of every individual tree and shrub, without the help of a guide.

It is a great omission, also, that there is no arrangement made for a general flower-garden or one for florist's flowers, for the exhibition of rare and showy kinds, as they seldom fail to create general attraction. These ought to form principal compartments in the pleasure-ground. The botanical arrangements



- 1, Small lodge and gate to keep the occupation road private.
- 2, Approach, with avenue of trees and footpath on each side.
- 3, Principal entrance from Leeds and Headingley road, with a level platform enclosed by a dwarf wall, on which are placed urns and vases.
- 4, Subterraneous passage to propagating pits, sheds, and compost-ground.
- 5, Sculptural or architectural ornament.
- 6, Keeper's cottage.
- 7, Repository for breeding animals.
- 8, Yard in which provender is to be kept for the various animals.
- 9, Experimental garden and shed for waiting carriages.
- 10, Curator's house.
- 11, House for parrots.
- 12, Propagating-pits and reserve-ground.
- 13, Terrace walk, surrounded by a very dwarf wall, on which urns and vases are to be placed.
- 14, Area for compost-sheds, &c.
- 15, Arcade, forming a passage from one extremity of the houses to the other.
- 16, Orange-house.
- 17, Green-house.
- 18, Heath-house.
- 19, Palm-house.
- 20, Stoves.
- 21, Conservatory.
- 22, Fern-house.
- 23, Orchideous-house.
- 24, Camellia-house.
- 25, Lawn on which are round beds of basketwork, for select flowers, also masses of select evergreen and flowering shrubs.
- 26, Cages for small fancy birds.

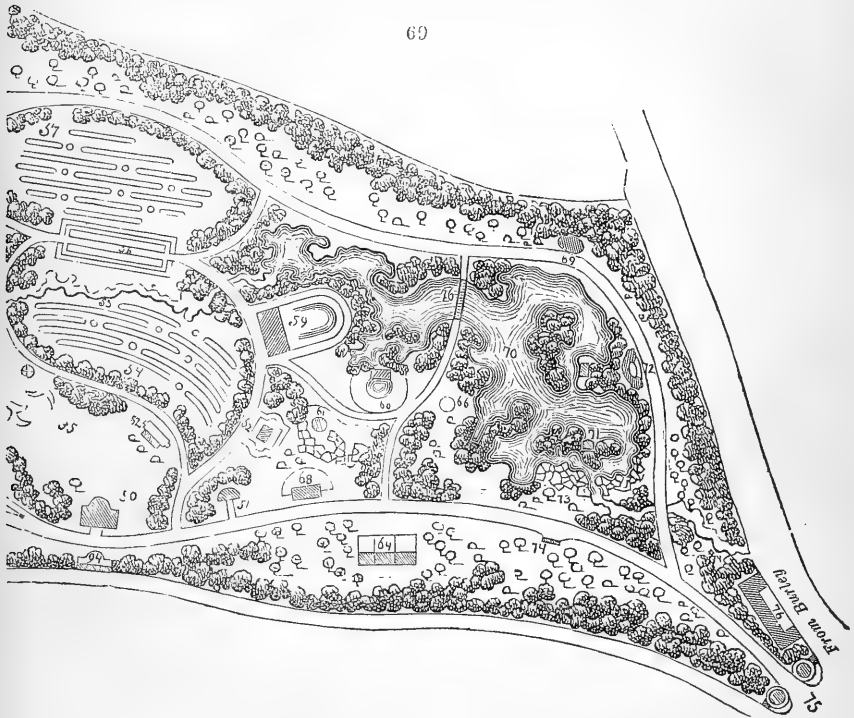
are never considered to stand in place of the flower-garden, as they are calculated to impart greater interest to the botanist, than the generality of visitors.

As this ground affords every opportunity for the introduction



- 27, Lawn, varied with beds of the most interesting shrubs and flowers; also standard roses, *Cytisus purpureus*, *Cotoneaster microphylla*, and other delicate-growing standard shrubs.  
 28, Aviary for various birds. 29, Monkey-house.  
 30, Bear-pit, to be viewed from a walk on high ground behind. 31, Grotto.  
 32, High source of water from which the fountains and the grounds generally are to be supplied.  
 33, Winter repository for animals.  
 34, Subterraneous passage, leading to and from the rockery and natural fountain.  
 35, General flower-garden. 36, Lions, tigers, and other carnivorous animals.  
 37, House and enclosure for reptiles. 38, Cage for squirrels. 39, Portable cages.  
 40, House for owls. 41, Pond and enclosure for alligators.  
 42, Rockery, water, and enclosure for otters. 43, Refreshment room. 44, Fountain.  
 45, Rockery, and enclosure for pelicans and storks. 46, Seat.  
 47, Tunnel, leading under public footpath to proposed horticultural gardens, &c.  
 48, House and enclosure for zebras and kangaroos, &c. 49, Gold and silver pheasants.

60



- 50, Museum, library, and committee-room. 51, Seat. 52, Turtle doves and pigeons  
 53, Garden for florist's flowers.  
 54, Botanical Garden for the natural arrangement, surrounded by a border of finest varieties of roses. 55, Rivulet, suitable for aquatic plants.  
 56, Structure for half-hardy shrubs, creepers, herbaceous, and aquatic plants.  
 57, Botanical arrangement according to the Linnean system, surrounded by American plants.  
 58, Mass of all the best kinds of rhododendrons.  
 59, House, paddock, and pond for an elephant. 60, House and enclosure for beavers.  
 61, House and rockery for eagles. 62, Structure for rapacious birds.  
 63, House and paddock for rhinoceros. 64, House and enclosure for deer and goats.  
 65, Boat-house. 66, Umbrella seat. 67, Bridge. 68, Seat. 69, Moss-house.  
 70, Pond. 71, Houses for swans and wild ducks.  
 72, Houses for vultures, hawks, and falcons.  
 73, Rockery suitable for rock-plants, with a small waterfall. 74, Seat.  
 75, Entrance-gates from Burley. 76, Sheds for waiting carriages and horses.

In the arboretum round the boundary, the trees are represented with stems, and the shrubs without stems.

of a rivulet, I cannot but feel surprised that it should have been omitted. It will be admitted by every one, that a natural rill, at one time rippling cheerfully amongst stones and pebbles,

occasionally thrown into increased murmurings by passing over groups of stones, pebbles, &c., and at other times spreading into small and silent lakes, is not only gratifying in itself, but affords suitable convenience for the growth of aquatic plants, which necessarily require such provision being made.

There is no space assigned for experimental garden, propagating-houses, reserve-garden, or compost-ground. How such a neglect could have happened, I am at a loss to conceive, as no public, or even private, gardens of any pretensions are ever without such conveniences. I think it also highly necessary, that there should be conveniences near to the garden entrances for waiting carriages, but nothing of this kind is shown in the plan.

---

ART. III. *Design for the Leeds Zoological and Botanical Gardens, presented to the Provisional Committee by Joshua Major. Communicated to the "Gardener's Magazine" by Mr. MAJOR.*

[THE plan (*fig.* 69.) described in the following references, is that to which Mr. Major alludes in the preceding article. It certainly appears to us to be far preferable to the plan of Mr. Billington in various respects, which are in a great measure independent of the locality; such, for example, as shutting out the boundary fence; extending the arboretum round the whole; keeping the water in the lowest part of the grounds; having a main walk and subordinate walks, &c. There are, however, various other points in Mr. Major's letter, of which it is impossible to judge without knowing the locality. The letter itself, taken as a whole, contains many excellent remarks of a general nature, and shows such a thorough practical knowledge of landscape-gardening, that the publication of it cannot fail to be useful, if not to the Leeds Committee, at least to the enquiring young gardener.]

(The plan and references are, for the sake of convenience, given in the two preceding pages.)

---

ART. IV. *Historical Notice of the Botanic Garden of Padua.*  
Communicated by Signor GIUSEPPE MANETTI, of Monza.

I SEND you the historical notices of the Botanic Garden of the university of Padua, which I received not long ago from Signor Robert de Visiani, Director of that establishment and Professor of Botany.

The garden of the university of Padua was founded by a decree of the senate of the republic of Venice, bearing date 30th

of June, 1545, in compliance with the request of the professors and students of medicine in the college, and more particularly at the entreaty of Francis Bonafede, at that period lecturer on simples, which is equivalent to what is now called Professor of *Materia Medica*. The reformers of the study next rented five squares and a half of land from the monks of Sta. Giustina, and, on the 5th of the following July, a public agreement was ratified with them. The formation and planting of the garden were intrusted to the celebrated Daniel Barbaro, native of Aquileja. The garden being founded, the direction of it was intrusted to Louis Anguillara, a Roman, with the title of herbalist and master, summoned from Bologna by a letter from the reformers, dated 18th August, 1546; and this was the first curator of the garden of Padua, in which charge he continued till 1551; to him succeeded Peter Anthony Michieli of Venice. Michieli was succeeded, in 1561, by Melchior Guilandino of Königsberg. He was desired by a letter from the reformers of the study to read, expound, and demonstrate, the herbs in the said garden to those scholars who went to see them, and therefore, from this period (20th February, 1563), we may consider the chair of botany to be instituted, which was called *Demonstration of Herbs*, to distinguish it from the *materia medica*, which was called *Lectures on Herbs*. To Guilandino succeeded, both in the garden and in the chair, James Cortuso of Padua, in 1590. After him the celebrated Prospero Alpino of Marostica, in 1603. To Alpino succeeded John Prevozio of Basilea, in 1616; then John Rodio of Denmark, in 1631; then Alpino Alpini, son of Prospero, in 1633; John Veslingio of Minden, in 1635; George della Torre of Padua, in 1649; James Pighi of Verona, in 1681; Felix Viali of Padua, in 1687; the illustrious Julius Pontedera of Lonigo, in 1719; John Marsili of Venice, in 1759; Joseph Anthony Bonató of Padua, in 1794, who vacated the chair in 1835; to which office the above-named Signor Robert de Visiani was nominated in 1837. In many of these professors the teaching of botany and that of the *materia medica* were united in the same person, viz., in Melchior Guilandino, Prospero Alpino, Alpino Alpini, John Veslingio, and George della Torre. The study of botany was highly esteemed by the republic, it being every year at considerable expense in sending intelligent persons to its islands in the Levant, Egypt, and even to India, to collect plants to enrich this garden. Under the Austrian government it has been increased by fine hot-houses, and with three movable conservatories, that is glass structures which are removed in spring.

The garden is situated between the two basilicæ of St. Antonio and of Sta. Giustina, a few paces distant from the large square of statues, called *Prato della Valle*.

It is surrounded on the north and west by a branch of the river

Brenta. It occupies an area of 20,664·37 square metri. The central part is enclosed and surrounded by a wall surmounted by a cornice, on which there is an elegant stone balustrade. This part is divided into many regular compartments edged with stone, and protected by iron rails. The area of these compartments is also subdivided into beds, divided from each other by means of borders of violets. Each bed contains only one species of plants, which by this means are more easily taken care of and cultivated. One of the four large compartments is allotted to the growth of medicinal plants which can grow in the open air, and which serve for the instruction of the pupils in medicine. Four large walks intersect the part just described, in the form of a cross; at the end of each there is an entrance gate, furnished with colossal pilasters, ornamented at top by an Etruscan vase of stone, containing the figure of a plant (generally an agave) of iron painted green, and closed by massive and elegant iron rails with bronze ornaments. Twelve fountains play in this enclosure. Besides these, there are also two large reservoirs for aquatic plants.

Southward lies the grove, or arboretum, of the garden, which, although almost destroyed by the memorable hail in 1834, has still some trees remaining, which, by their girth and height, attest the antiquity of this establishment. For example, a *Plátanus orientális* 21·78 metri (a metro is 39·3 in.) in height, and 2·25 metri in diameter, which, according to tradition, is coeval with the foundation of the garden, that is, almost three centuries ago. A tulip tree (*Liriodéndron Tulipífera*) 28·8 m. high, and 87 m. in diam. An *Ailántus glandulòsa* 29·88 m. high, and 0·65 m. in diam. A *Jùglans nìgra* 32·15 m. high, and 1 m. in diam. A *Vibúrnum pyrifòlium* 10·38 m. high, and 0·29 m. in diam. A *Pinus Cèdrus* (*Cèdrus Libàni*) 16·75 m. high, and 0·42 m. in diam. A *Quércus coccífera* 8·8 m. high, and 0·36 m. in diam. A *Salisbùria adiantifòlia* ♂ [male] 5·5 m. high, and 0·47 m. in diam. A *Sàlix annulàris* 7·9 m. high, and 0·2 m. in diam. An *Acer Pseùdo-Plátanus* 25·4 m. high, and 0·57 m. in diam. A *Quércus Ilex* 16·3 m. high, and 0·46 m. in diam. A *Mèlia Azédarach* 18·4 m. high, and 0·6 m. in diam. A *Gledítschia triacánthos* 27·2 m. high, and 0·75 m. in diam. A *Cárpinus Bétulus* 28·2 m. high, and 0·75 m. in diam. A *Cárpinus orientális* 18·15 m. high, and 0·22 m. in diam. A *Vítex Ágnus cástus* 6·45 m. high, and 0·25 m. in diam. A *Plátanus occidentális* 20·8 m. high, and 0·95 m. in diam. A *Pópulus álba* 25·8 m. high, and 1 m. in diam. A *Stýrax officinále* 4·6 m. high, and 0·28 m. in diam.

To the north of the central part, already described, are situated the ample magazines, sheds, reserve-ground, &c., of the garden, the conservatories, and the hot-houses. The latter

buildings are scientifically constructed, and command a fine view. The range is 55 m. [180 ft.], long, and is divided into seven houses, the largest of which is in the centre, and serves as a stove: at the right and left of this are two houses, which are not heated; that on the right contains a stage for plants; the other, on the left, is beautifully arranged for the reception of seeds and fruit. After the first of these houses, there is a warm green-house, or dry stove, to which succeeds a house of equal size, which contains the green-house plants. Next to the seed-room a hot-house (*serra*) runs to the left, in which the plants are not in pots, but planted in the borders, and the heat circulates under the borders. This hot-house contains beautiful specimens of banana (*Musa paradisiaca*), some of which flower and ripen their fruit almost every year; and a *Ficus stipulata*, the infinite ramifications of which have covered the entire walls of the house with their beautiful verdure. After this comes another house, similar to the former, where green-house plants are kept, and principally those from New Holland. The hot-house (*caldario*), and the two temperate houses (*tepidarii*) are warmed by fire heat.

This garden is celebrated for a rich collection of succulent plants, which, thanks to the assiduity of the present director, is continually on the increase. In the central part we behold a beautiful specimen of the tree variety of *Chamærops humilis*, of the height of 5.50 m., which is covered, however, in winter; and two beautiful specimens of *Magnolia grandiflora* in the open air, the highest of which is 15.24 m. high and 0.46 m. in diam., the other is 14.48 m. high and 0.51 m. in diam., which are covered every year with numerous flowers.

To the west are situated two houses, a smaller one, which is occupied by the two gardeners of the establishment, and a larger house, which is the dwelling of the director and professor of botany, and in which the herbarium of the garden is kept. It contains more than 6000 species (the herbarium belonging to the present professor is much richer), a collection of fungi in wax, one of exotic fruits, and a library, chiefly botanical, of more than 5000 volumes, left for the use of his successors by the praiseworthy Professor Bonato.

The garden of Padua, from the elegance of its arrangements, the number and size of its buildings, and the goodness of its soil, from the copious supply of water which is diffused throughout by the application of a hydraulic machine, which is opposite the entrance gate; from its position between two splendid edifices; and from the superior construction of its hot-houses, is in no degree inferior to the botanical gardens of any other university, as it is superior to them in antiquity; that of Pisa, which some assert to be anterior, being founded after this, as Mathioli satisfac-

torily proves, in the preface to his *Commentaries*; an author who was contemporary with the foundation of both gardens, and worthy of belief.

*Monza, near Milan, February 21. 1839.*

---

ART. V. *Results of certain Experiments in Kyanising different Species of Wood for being used as Garden Tallies; with Remarks on the Effect of Kyanising Hop-Poles.* By W. MASTERS, F.H.S., &c.

AT our last interview we had some conversation on the efficacy of Kyan's patent for the preservation of wood. On that occasion I promised a more detailed account of my experiments, which I now proceed to give.

About four years ago, I had portions of oak timber sent me, that had been placed in what is called the Fungus Pit, at Sheerness. They were represented as portions of the selfsame tree, that, at the same time, had been placed in the pit, which was air-tight, and in which was other timber in a decaying state from the effect of what is commonly called dry rot. The difference between the two pieces sent was remarkable; the one literally dropping to pieces, and showing the concentric plates almost without the longitudinal fibre, and the other firm, compact, and preserving its sharp edges, as though it were but recently cut from the tree. It is needless to say the one piece had been subjected to the patent process, and the other had not.

Upon the fact becoming generally known, the most extravagant results were anticipated; our large landed proprietors began to fear that, so soon as timber generally was subjected to the Kyanising principle, as there would be no more decay, the greater part of the wood grown would become of no other value than for fuel; whilst the carpenter plainly saw the end of his industrious earning, if, when a fenced gate or a house were once formed no after repair would be necessary. Nor was this all; it soon became confidently asserted that the least valuable of wood, such as that produced from poplar, willow, sycamore, elms, and other quick-growing trees, after being saturated with the chemical liquid, would become in all respects equal to heart oak.

In our district the hop-growers seized the idea, and fondly imagined that they had found what had years ago been promised by Cobbett, "everlasting hop-poles. Under this impression, thousands of poles of beech, birch, and other soft woods were placed in Kyan's tanks in Canterbury, mingled indiscriminately with those of ash and chestnut. In order the more perfectly to

ascertain its effects, I caused to be cut down from the nursery specimens of all the British and foreign trees that I could spare, and having had them shaped into number-sticks, sent them to the tank that was to confer upon them equal durability. With these sticks freshly cut down, and with the sap in them, I sent others that had been shaped a year or two before, and had become well seasoned. Soon after they were returned to me I applied them to the purpose for which they were originally intended, and now, at the lapse of between two and three years, I proceed to give you the result.

On no one specimen of those that were cut down green and immediately immersed has fungus of any kind appeared, be the wood hard or soft, British or foreign; but on some of those that had been previously seasoned, small quantities now and then appear, thus proving to a demonstration, that, for complete success, it is essential that the active vital principle of the wood should not be obliterated.

We now come to the question of durability. In the eagerness of first discovery, the advocates of the process entirely overlooked the fact, that wood was injured or destroyed by other agents than by *dry-rot*, and hence a great disappointment has ensued among the hop planters, because, during the tempestuous weather of the past autumn, when the poles were supporting the greatest weight, those Kyanised would not resist the wind better than those that had not been submerged in the solution. The truth is this, the preparation can only preserve such fibres as it has to act upon. When applied to woods that have inherently no strength, on account of the want of interlacing of the concentric and longitudinal fibres, it would be unreasonable to suppose that, by preserving from decay, it could give texture and resistance equal to those kinds of wood where toughness and durability are naturally obtained by the arrangement of fibre. It follows, then, that at least one of the evils may effectually be prevented to which all hop growers are subject, namely, by choosing their poles of proper woods, and by sending them, while in a green state, to the tank, they will prevent the necessity for *sharpening at each successive year*; and, as far as I can at present judge, if a good pole would, in the ordinary course, last three or four years, its duration will, in all likelihood, be extended to double that period; but where the material is bad, although the pole is not destroyed by its parasite, it is equally subject to the accident of wind.

*Exotic Nursery, St. Peter's, Canterbury,*  
March 20. 1839.

ART. VI. *Remarks on the Gardens of the Royal Botanic Society of London, Inner Circle, Regent's Park.* By the CONDUCTOR. (See Vol. XIV. p. 530. 559.)

THE following letter appeared in the *Times Newspaper* of May 10. 1839:—

Sir, I take the liberty of addressing you on the subject of the prospectuses and engraved plans issued by the "Royal Botanic Society," and the works now going on in laying out the gardens of that Society in the Inner Circle, Regent's Park. I should have done this long ago, but I had not, till yesterday, an opportunity of visiting the site of the intended garden, nor was I aware, till I was on the grounds, that a second plan for its arrangement had been engraved and circulated. The circumstance of this second plan being very different from the first, and the glaring faults which I see in both, have occasioned me to trouble you with this letter, in the hope that your publication of it may induce the Botanic Society to reconsider their plan and prospectus before proceeding any further in laying out their grounds. This I am most anxious that the Society should do, being decidedly of opinion that if either of the engraved plans be carried into execution, the garden of the Royal Botanic Society will be a disgrace to the taste of the country, and altogether discreditable to the noblemen, ladies, and gentlemen, whose names appear on the prospectus, as vice-patronesses, vice-presidents, vice-patrons, members, and proposed fellows. Any one may receive the prospectus and last engraved plan, simply by asking for them at the Society's offices in Pall-Mall, and in the Inner Circle, Regent's Park; and at the latter place he may also see the operations going forward on the grounds. When both have been examined by any person at all conversant with the subject of laying out grounds, he will, I think, be astonished at the circumstance of so much ignorance and presumption as the plans, the prospectus, and the operations evince, being backed by so many of the names of our first nobility and gentry, many of whom are well known to be persons of refined taste in landscape-gardening. As it is quite evident that these persons must be perfectly unaware of the absurdities which are being committed under the sanction of their names, I consider it a duty which I owe to them, as well as to the public at large, to entreat them to reconsider the subject of the Institution which they are patronising.

Having referred to the engraved plan and the prospectus, which every one who wishes it, may readily procure, it will be unnecessary to go much into detail. The prospectus states that the Botanic Society is to be an institution with extensive botanic gardens, library, museum, studio, hot-houses, conservatories, &c. ;



and though the Inner Circle appears to me too much in the smoke of London for the cultivation of a large proportion of the plants which are necessary to form a tolerably complete botanic garden, and though the soil is one of the worst that could be found for this purpose, being a stiff clay on a wet bottom, yet I consider the situation excellent; and I think that an ornamental botanic garden might be formed, which would prove a most agreeable scene of recreation, and a source of useful instruction, to a great proportion of the inhabitants of the neighbourhood. I say this from a knowledge of what can be done in the stiffest clay soils by an effective system of under drainage; and from the additional fact, somewhat remarkable, that many plants which require to be grown under glass, and more particularly tropical plants (being in an artificial climate), can be grown almost as well in the immediate vicinity of London, and other large towns, as in the purest air in the country. As a proof of this, I may refer to the palms and other tropical plants, and to the camellias, in Messrs. Loddiges's hot-houses and green-houses, at Hackney. I do not say that Cape or Australian shrubs, such as heaths, proteas, banksias, &c., can be grown as well in the Regent's Park as in Kew Gardens; but I again refer to the glass structures of Messrs. Loddiges, to prove that they can be grown there tolerably well. With respect to hardy trees and shrubs, the point as to how far the more delicate species will thrive in the Inner Circle of the Regent's Park, may be ascertained in a satisfactory manner by examining the arboretum of Messrs. Loddiges. This admirable collection contains specimens of all the trees and shrubs indigenous or introduced, that will endure the open air in Britain. Messrs. Loddiges's collection has been planted nearly 20 years; and hence, to ascertain what trees will bear the London smoke, it will be only necessary to look through it, and to observe what kinds are thriving, and what merely live and look miserable. With respect to herbaceous plants, all the commoner kinds, and, perhaps, many of the more rare species, will thrive, or at least live, in the Regent's Park; and a number of delicate alpins and European orchises, which would only last a year or two there, could be renewed from their native localities, or by exchange or otherwise, with botanic gardens in the country, where the air is purer.

I state these particulars, to show what I meant by saying that, notwithstanding the disadvantages of the Inner Circle, I think it might still be made a most delightful and instructive garden. I object to both the engraved plans for laying out the Inner Circle, as I think that they are not calculated to attain this object, from attempting a great deal more than can be carried into execution, so as to have an efficient effect in a space containing

only 18 acres. There are to be Italian, English, Dutch, Swiss, Oriental, and American gardens, besides gardens attached to the botanical museum and library, a medico-botanic garden, a rosarium, arboretum, and shrubberies, mound with observatory, lawn surrounded by foliage for busts of celebrated botanists, promenade, lake for aquatic plants, and small islands, with many other particulars, including statues, vases, sundials, and other works of art, liberally scattered over the whole space. In short, the plan contains all the elements of a cockney garden, or rather of several cockney gardens huddled up into one. The consequence of attempting to get so many kinds of gardens and other scenes and objects into so confined a space is, that the ground will be frittered down into a multiplicity of small parts, round, square, or polygonal, and connected by winding walks, inosculating or crossing one another in all directions, giving the whole the appearance of a collection of arbours for a Parisian tea garden; such a *jardin Anglais* as we have seen attached to a *guinguette* in the environs of the French capital a few years ago. The plan displays no leading feature, and the hot-houses are scattered up and down in such a manner as to produce no grand general effect.

On the ground I observed some lines and forms staked out, which I was told were different from either of the plans published; from this, and from the manner in which the draining has been commenced, I conclude that the members of the Botanic Society have not yet finally fixed on their arrangements, and that it is not too late for them to reconsider their proceedings. That they may do this, and ultimately produce a garden worthy of the situation, and of the present state of taste in, and knowledge of, gardening, is my sincere wish; and, as I have already said, is my object in troubling you with this letter.

*Bayswater, May 9. 1839.*

The first step to be taken before forming either a ground plan of the garden scenery, or elevations of the different buildings, is to take the levels of the surface with perfect accuracy, and to measure the depth of the surface soil throughout. The situation of the walks and buildings being next fixed on, a system of under drainage must be devised, which will admit of repairs, without disturbing either the walks or any of the buildings. Estimates ought to be given of the expense of executing every particular object, accompanied with suggestions respecting what must of necessity be carried into effect, and what may be deferred, in case there should not be sufficient funds. All the plans, details, and estimates being made, the plans ought to be lithographed, and accompanied by a description, and by reasons for every thing proposed. This would form a work which ought to be put in circulation, and

the members of the Society, and the public generally, and more especially the public press, ought to be invited to send their criticisms on it. After a sufficient period had elapsed, it would then be for the competent authorities to determine how far the plan was to be carried into execution.

---

ART.VII. *List of Coniferous Trees in the Pinetum of Baron de Serret, at Beernem, near Bruges.* Communicated by BARON DE SERRET.

I HEREWITH send you a list of my collection of coniferous and resinous trees [referred to in the *Arboretum Britannicum*, vol. iv. p. 2452.], where, as you will observe, the species and varieties are given in the order in which they are described in the *Arboretum Britannicum*.

The collection which stands on my estate and country residence at Beernem (a village distant about two leagues to the south of Bruges) was commenced in the year 1802, with the sole object in view at the time, to provide the means of ascertaining whether some at least of the many trees which botanists have classed amongst the varieties of the *Pinus sylvéstris* do not, in fact, afford such differences, either in their habits or the quality of their timber, as to entitle them to be ranged amongst the species. The plantation was, in consequence, limited, for the first and second years, to such species and varieties; seeds or plants being procured from every quarter (the north of Europe in particular) where they were known to grow; and these were planted on a spot of ground exclusively adapted for the purpose, either apart or in groups or masses, according to the quantity of plants obtained. Without in the least abandoning this plan (in which I still persevere), I soon determined to collect all the species of the genus actually known and obtainable. Where these were sufficiently hardy to endure the open ground in our climate, they were planted in succession and on the same spot as the former, in masses or groups, if the species were not a rare one, and single, if for the moment it happened to be so. The tender sorts are kept in pots or boxes, and removed to the green-house during winter.

By the successive additions which in this manner have been made to the original plantation, it now occupies a surface of about seven English acres; and many of the exotic species, such as the American spruces, larches, hemlock, and balsam firs; *Pinus Ströbus*, *Thùya*, *Cuprëssus thuyöides*, &c., are so far acclimatised, that they multiply to a considerable extent by self-sowing. This circumstance may, indeed, be partly attributed to the nature of the soil, as the same here occurs with the *Rhododéndron máximum*, *Rh. pónticum*, and *Rh. punctátum*, the

*Kálmia latifolia* and *pùmila*, the *Azàlea pòntica*, the *Myrica pennsylvànica*, and a few American deciduous trees.

- Casuarina equisetifolia*, Arb. Brit. p. 2060.  
*Éphedra distachya*, 2063.  
*Taxus baccata*, 2066.  
*fastigiata*, 2066. var. 2.  
*procumbens*, 2067. var. 3.  
*Podocarpus macrophyllus*, 2100.  
*elongatus*, 2101.  
*Pinus sylvestris*, 2153.  
*horizontalis*, 2155. var. 2.  
*rùbra*.  
*rigensis*, 2157. var. 5.  
*genevensis*, 2158. var. 6.  
*uralensis*.  
*uncinata*, 2156. var. 3.  
*pumilio*, 2186.  
*Mughus*, 2187. var. 4.  
*altissima*.  
*Banksiana*, 2190.  
*inops*, 2192.  
*variabilis*, or *mitis*, 2195.  
*pungens*, 2197.  
*Laricio*, 2200.  
*caramànica*, 2201. var. 3.  
*calábrica*, 2201. var. 4.  
*taúrica*, 2202. var. 7.  
*austriaca*, or *nígricans*, 2205.  
*Pallasiana*, 2206.  
*pyrenàica*, 2209.  
*resinosa*, 2210.  
*marítima* *màjor*, 2213.  
*minor*, 2216. var. 4.  
*Massoniana*, 2218.  
*Pinea*, 2224.  
*halepensis*, 2231.  
*brùtia*, 2234.  
*Tæ'da*, 2237.  
*rígida*, 2239.  
*serótina*, 2242.  
*ponderosa*, 2243.  
*Sabiniana*, 2246.  
*Coultéri*, 2250.  
*longifolia*, 2252.  
*Gerardiàna*, 2254.  
*austràlis*, 2255.  
*canariensis*, 2261.  
*sinensis*, 2264.  
*insignis*, 2265.  
*pátula*, 2266.  
*Llaveàna*, 2267.  
*adúnca*, or *califòrnia*, 2268.  
*nepalensis* } supposed to belong  
*serenagensis* } to sp. *longifolia*.  
*Drummondii* (nova species).  
*Cembra*, 2274.  
*sibírica*, 2275. var. 1.  
*Pi. Stròbus*, 2280.  
*compréssa*, 2230. var. 4.  
*montícola*, 2291.  
*pygmæ'a*.  
*excélsa*, 2285.  
*Abies excélsa*, 2293.  
*péndula*, 2294. var. 4.  
*Clanbrasiliana*, 2294. var. 6.  
*pygmæ'a*, 2295. var. 8.  
*tenuifolia*, 2295. var. 9.  
*gigantèa*, } Loddiges's Cat.  
*NovæHollandiæ*, } 1838.  
*álba*, Arb. Brit. p. 2310.  
*nìgra*, 2312.  
*rùbra*, 2316.  
*Morinda*, or *Smithiana*, 2317.  
*mexicàna*? Parmentier's Cat.  
*Douglàsii*, Arb. Brit. p. 2139.  
*canadensis*, 2322.  
*Picea pectinata*, 2329.  
*Pichta*, 2338.  
*balsamea*, 2339.  
*Fraseri*, 2340.  
*nóbilis*, 2342.  
*Webbiana*, 2344.  
*taxifolia*, Loddiges's Cat.  
*Làrix europæ'a*, Arb. Brit., p. 2350.  
*sibírica*, 2352. var. 8.  
*dahùrica*, 2352. var. 9.  
*intermèdia*, 2352. var. 10.  
*microcarpa*, 2399.  
*péndula*, 2400. var. 2.  
*Cèdrus Libàni*, 2402.  
*Deodàra*, 2428.  
*Araucària imbricàta*, 2432.  
*brasiliàna*, 2439.  
*excélsa*, 2440.  
*Cunninghàmii*, 2433.  
*Cunninghàmia sinensis* } 2445.  
*or Bèlis jaculifolia* }  
*Thùja occidentàlis*, 2454.  
*orientàlis*, 2459.  
*tatàrica*, 2459. var. 3.  
*articulàta*, 2462.  
*Warreàna*?  
*Cuprèssus sempervirens*, 2464.  
*horizontalis*, 2465. var. 2.  
*zhuyòides*, 2475.  
*gláuca*.  
*péndula* var. *lusitànica*, 2477.  
*tríquetra*, 2464.  
*torulosa*, 2478.  
*dísticha* (*Taxodium*), 2481.  
*péndula*, 2481.  
*imbricàta*.  
*Tournefòrtii*, or *thurífera*

Cup. capénsis, Loddiges's Cat., 1830.	Ju. bermudiàna, 2498.
austràlis.	dàurica, 2500.
articulàta.	phœnicea, 2501.
repànda.	lýcia, 2502.
occidentàlis.	thurífera, 2503.
Juníperus commúnis, Arb.Brit., p.2489.	excélsa, 2503.
Oxýcedrus, 2494.	recúrva, 2504.
drupàcea, 2494.	chinénsis, 2505.
virginiàna, 2495.	Sabìna, 2499.
hùmilis, 2495. var. 2.	prostràta, 2499. var. 4.

*Bruges, March 11. 1839.*

---

ART. VIII. *Remarks on the Usefulness of Birds in Agriculture and Gardening.* By G. ORD.

I HAVE been reflecting much upon the conversation which we had together, a few evenings ago, on the subject of the usefulness of birds to agriculture. The farmers of Great Britain, as well as those of North America, are influenced by prejudices which a little investigation of the economy of nature would tend to remove. The rook is by many esteemed a noxious bird; and yet his services, in the grub-destroying way, are beyond estimation. There is no knowing what would be the disastrous result of his extirpation. The common sparrow is a favourite bird with me. Were I an English farmer, I should encourage this industrious and lively little fellow to take up his abode with me, under the full persuasion, that the little grain he would devour would be more than compensated by the thousands of harmful insects that he would destroy. The sparrows have entire liberty at Walton Hall, the seat of our friend, Charles Waterton, Esq.; but we hear no complaint of their depredations. Even of the choice fruit they take but a little, and this is not begrudged them by their generous protector.

When residing in the interior of Pennsylvania, I made an interesting experiment. Being fond of rearing poultry, I had a large stock at seed-time, between four and five hundred domestic fowls. My wheat field was near the house, and my farmer maintained that, unless the fowls were locked up, there would be no crop. Not being disposed to imprison my favourites, I gave orders to sow a piece of ground alongside the barn, about half an acre, with wheat, for the sole use of the poultry. I must confess that I did not suppose many grains would have the liberty of vegetating, so thorough a scratching did the place undergo. However, the wheat began to spring, and gave indications of a crop. When the grain was ripe, my farmer said he thought it was worth cutting, as it appeared to have received but little injury from the fowls. In short, the damage done by the fowls did not, in our estimation, amount to

two bushels of wheat, whilst we had the benefit of the produce of the poultry in eggs and chickens, of far greater value than what they destroyed in the way of grain; to say nothing of their invaluable services in the insect-destroying way. My farmer was greatly astonished; and confessed that the *hens*, as he called them, were not so destructive as he had always imagined they were. I must observe that it was my practice to feed regularly my poultry; under the persuasion that a good meal was quite as beneficial to the fowls as to myself. Let all those who attend to rural economy pay attention to this matter, and they will find their interest in it.

In my late journey into Holland, I had the gratification of observing the good feeling of the Dutch, with respect to the feathered creation. Their fondness of the stork is well known; but they also protect the rook, the jackdaw, the wood pigeon, &c. In Rotterdam I lodged in a hotel, situated on the quay of the Meuse, called the *Boompjes*. This quay is ornamented with a row of venerable trees, which are inhabited by jackdaws, ringdoves, starlings, and sparrows; all living in friendship, building their nests and rearing their young, in perfect security. A stranger, unaccustomed to such a spectacle in a busy commercial city, would be surprised, as I certainly was, on being awaked, at early dawn, with the cawing of the daws, the chattering of the starlings, and the cooing of the doves, in a place where no sounds would be expected but those which are the concomitants of a maritime port. Whilst sitting in my window, to enjoy the morning air, the ringdoves would alight within a few feet of me, without manifesting the least alarm; thereby affording me an opportunity of admiring the graceful form, and glossy plumage, of this beautiful bird. I really envied the Dutch their happiness in this particular.

*London, May 10. 1839.*

---

ART. IX. *Note on the Jalap Plant of Commerce.* By D. BEATON.

AT the last November meeting of the Botanical Society of Edinburgh, Dr. Graham stated that *Ipomœa pûrga* is now believed to be the plant which produces the true jalap of commerce. That he received a tuber of it from Dr. Christison, which flowered freely in a stove, and proved to be quite distinct from the *Ipomœa* hitherto in cultivation in our stoves as the jalap plant. In the *Annals of Natural History* for this month, in which I read a notice of the above meeting, the authority for the specific name *pûrga* is not stated, and I cannot find it in any work to which I have access. The true *Ipomœa*, or *Convólulus Jalàpa*, was cultivated in the Chelsea Botanic Garden

in Miller's time. After his death, the plant was lost to that garden, and to the collections of this country. Sometime afterwards *Ipomœa macrorhiza* usurped the place of the jalap plant in our stoves. Curious collectors latterly had each his jalap plant in his stove. At Haffield, we had our jalap plant, but not *Ipomœa macrorhiza*.

My present esteemed employer received a few tubers last year from his Mexican collector: they were from Xalapa; and from the appearance of their foliage, when they began to grow, I took them to be a species of *Dioscœrea* (the venation of the leaves in that genus being no index to its botanical affinity), and paid little attention to them. One I kept all the season in the *Cácti* house where it flourished well, and seemed quite at home, but did not flower; another I planted in the open garden, against a rhododendron bush, a good plan for all duplicate novelties from such a country as Mexico, from which both hardy and tender species have been received. This latter plant showed a considerable number of flower buds in September, in twos and threes on short peduncles in the axils of the leaves. Only one of these, however, expanded, owing to the lateness of the season; and it had a long narrow tube, and a spreading medium-sized limb of a delicate violet colour; and the plant altogether appeared a graceful climber. You may guess my surprise on sending this flower to one of the first botanists of the age, to be told that it was the plant which produced the true jalap of commerce, *Convólulus Jalapa*. I think from this statement we may safely infer that the true jalap plant will flower better in a cool house than in the stove. I expect our plant will flower well out of doors this season, being preparing it now for that purpose. It was received last year in May, and, of course, lost much time of the growing season. If this is different from the Edinburgh *I. púruga*, I shall be glad to send a dried specimen of it to the Botanical Society there; but I shall learn this "time enough" from Mr. M'Nab, who, I am happy to see, is one of the councillors of that Society.

*Kingsbury, April 6. 1839.*

---

ART. X. *Some Remarks on Brazilian Esculents and Fruits.*

By Dr. JOHN LHOTSKY.

ALTHOUGH the objects, to which the following paper relates are mostly known, as far as their botanical description is concerned, their economical, horticultural, and similar relations have been hitherto but little broached. Besides, every thing connected with practically useful plants, is so far important, as no one can say whether any, less known or not properly appreciated at the present moment, may not become hereafter of a paramount importance. The most useful esculent substance of the Brazils, is the *Farinha*, the fecula or farina produced from the roots of *Játropa Mánihot* L., *Janípha Mánihot*

Kunth. Of this, three varieties are grown: the *Mandiocca* *preta*, *branca*, and the *Impin*.\* The first is the most common, and has a thick substantial root, at times quite conical, attaining a weight of from 8 lb. to 10 lb., brown externally, and the epidermis of which consists of small scales; internally it is white, and the whole root, on being wounded, yields a milky juice. The stem also is bigger and darker, than in the two other varieties. The root of the *Mandiocca* *branca* does not attain so large a size, and it is more elongated, and externally paler than that of the preceding kind. The cultivation of all varieties of *Játropha*, is attended in Brazil with very little trouble. The stem is entirely covered with knots (the remnants of the old leaves); which, even after having been a long time out of the ground, remain in a fresh and vegetative state, as I had some in my house, which, after they had been there for six weeks, without any attention being paid to them, vegetated vigorously. The way of growing the *Mandiocca* is, therefore, simply to cut pieces of the stem, from 4 in. to 6 in. long, and to plant them at any season of the year. They like a dry and loamy soil, and yield without farther trouble, in three or four months eatable, and in ten or twelve full-grown, roots; yet they remain for five years in the ground without injury. The roots of the *Mandiocca* *preta* are grated in small pieces by a machine turned with a wheel, the pieces are then freed from their poisonous juice by compression, and afterwards dried, an operation which has been already described in Piso's *Historia Naturalis*, who wrote in the seventeenth century. Nearly in the same way, the *Mandiocca* *branca* is prepared. The roots of the *Impin* finally are boiled or roasted, and do not require much cooking; their flavour is between that of the celery and the potato. The varieties of *Játropha* attain generally the height of from 5 ft. to 7 ft., being the most important produce of every Brazilian farm. The farina resembles grits, and may be eaten raw, but more generally it is scalded with hot water or broth, and forms then, under the denomination of *Pirão* or *Angú*, a dish, the more extensive introduction of which into Europe, and far more on board ships, would be highly commendable. In this state it is partly jelly-like, and more delicate than either grits or rice, and therefore well adapted to serve as a substitute for fresh bread, in which capacity it is used in the Brazils.

The next important tropical esculent is the Inghame (the common yam), the tubers of *Dioscòrea* *sativa*, which acquire a weight from 1 lb. to 3 lb. There are two varieties, the Inghame *da terra* and *I. da agua*. The tubers are more or less cylindrical, and of a darkish brown colour. These plants are propagated in the same manner as our potatoes, viz. the root is cut in circular pieces, and planted in rather a light and damp soil. They are served up either boiled or mashed, and their flavour is between that of a potato and a parsnep. The *batatas* (*Convólulus* *Batàtas*) are tubers, much resembling a small kidney potato with a thin red epidermis. Their flavour is indifferent, and they become, after being boiled, a soft sweetish mass, not unlike that formed by the Jerusalem artichoke. Another esculent is the Chiavo, the unripe capsules of *Hibiscus* *esculentus*. When about 2 or 3 inches long, these capsules are boiled with meat, and form a rather tasteless, but nutritious food. Interesting also are the Mandubi beans or Brazilian earth nuts (*Arachis* *hypogæa*), which grow under the ground, and are of a reddish colour, like kidneybeans. They yield, when pressed, a great deal of oil.

A most important, although not indigenous, sort of esculent in the Brazils are kidneybeans, especially a small black variety. The ripe seeds of these, boiled with salted or dried meat until they are nearly broken to pieces, are the common food of the negroes and of the poorer classes. For spice, several kinds of pimenta (*Cápsicum*) are cultivated; the small fruits of which are squeezed and scalded with a little broth, and used in that way, with either

---

\* Martius mentions only the *mandiocca* and *aypim* roots. (See *Reise*, &c., vol. i. p. 118.)



fish or flesh ; or they are mixed and boiled with the food, and considered very wholesome.

Every traveller, on leaving Europe, is very anxious to become acquainted with the tropical fruits, as, with the exception of their botanical definition, they have not been much noticed. But to European palates and constitutions, they do not afford that relish which our native fruits do, and, accordingly, I must confess that (with the exception of the ananas) none of them, at least in their present state of cultivation, can be compared with the peaches, pears, raspberries &c., of Europe. The general character of all Brazilian fruits is a certain mucilaginous sweetness, which is more or less insipid, and without much fragrance, to which, besides, in most of them (for example, in the manga and pitanga), a terebinthine taste is perceptible. The most important fruit tree of the Brazils is the banana (*Musa paradisiaca*), the charming and characteristic ornament of all tropical gardens and fields. There are two varieties grown, of which the Banana de St. Tomé yields smaller and more delicate, and the B. da terra longer but coarser, fruit. Although extensively used, it has not much flavour, and is of a dry farinaceous quality ; but, roasted with butter, it is much better. To sea-faring people it is of great importance, as its bunch of fruit, weighing from 12 lb. to 30 lb., if gathered before it is perfectly ripe, and suspended in an airy place, will keep for a long time, and be improved by keeping.

Of oranges, citrons, and limes, there are many varieties, of which the following are the most general: Laranja da Terra, L. da China, L. Tanjera, L. Tanjerina, L. Celetra, L. d'Embigo, Limon acedo, L. doce, and L. Cedro. This list I obtained at the Quinta dos Lazaros, at Bahia, a garden which is very celebrated for the growth of these fruits, for which, indeed, the whole province of Bahia is renowned. The Laranja d'Embigo (seedless orange) is certainly the best ; yet, people who have tasted good oranges at Malta, or in Portugal, do not eat oranges in the Brazils, but with sugar. Another particularity of most of the Brazilian oranges is their pale skin, and the last-named variety has a quite green appearance, even when arrived at maturity. It has been said in the Brazils, that the orange is indigenous, having been found in some of the primeval forests of the interior. Yet, even if this should have been the case, I would still doubt the above assertion, in a country brushed, as it were, for the last 300 years by Europeans.

With respect to the pine-apple (growing here in a half wild state), I have only to mention, that it ripens in Rio a month later than in Bahia, at which latter place, the period when all fruits are most plentiful, is the month of December. It is said of the pine-apple as well as the orange, that those growing in the Brazils, have not so much flavour, as those reared in the pineries of Europe.

The following Brazilian fruits are not of such great economical importance, as those, which have been already mentioned. A very interesting one is the Acajú, or cashew nut (*Anacardium occidentale*), which is of a most extraordinary shape ; as a part of the enlarged peduncle forms the eatable fruit, which is fleshy and like a pear, above which is the nut, shaped like a large bean ; the fruit is yellowish or reddish, rather soft, and of an acidulous particular taste. It is sometimes eaten entire ; but more generally a sort of lemonade is expressed from it, to which depurative and antisiphylitic qualities are ascribed, and which is drunk here generally, and very copiously. The nut contains, between the external shell and the kernel, a milky narcotic juice, the evaporation of which by roasting renders the kernels edible.

One of the finest fruits is the Mango (*Mangifera indica*) ; and the tree is equally worthy of admiration ; its majestic and gigantic stems overshadowing whole streets with its dense and dark foliage. The fruit is drupaceous, of the shape of a compressed ostrich's egg, the colour is yellowish green, and at times partly red. If this fruit be cut, its flesh, which is orange-coloured, presents a fine contrast with its green skin. The mango has a sufficiently good taste, with the exception of the above-mentioned turpentine admixture.

In the East Indies it is said to be most delicious, and without any terebinthine taste. Perhaps its culture in the last-mentioned country is more ancient; a remark which would lead us into theories of tropical horticulture, unnecessary to be broached on the present occasion.

Frutta de Conde (*Anona squamosa*) is of a roundish form, pointed at the base, scaly, and of a yellow-green colour. It contains many blackish seeds, surrounded by a whitish flesh. This is one of the best tropical fruits, delicately sweet, and somewhat spicy. The Mamão, or Melon tree (*Cárica Papáya*), is planted around the Brazilian houses, on account of its rapid growth, and bears a whole row of fruit on short peduncles, and which come out of the upper part of the simple stem. The fruit resembles a small melon; the flesh, however, is soft, and without any particular qualities.

The Pitanga (? *Eugènia pedunculata*, ? *Eugènia Michèlii*, *Cerisier de Cayenne*), which is a drupaceous fruit like a cherry, yet angular, has most probably run wild in the forests of Bahia, where, therefore, it is one of the very few wild fruits, which comfort the weary traveller, yet its terebinthine quality impairs its flavour.

The Grumjama, or Brazilian cherry (most probably also an *Eugènia*), is twice as big as a large black-heart cherry, and also of the same colour. The best fruit, however, of this tribe is the Cambuca, round, yellow, and of the shape of a very small apple. Around the solitary, rather large, kernel is the delicate flesh, of a yellowish red colour, which, especially that next to the kernel, has an excellent vinous and acidulous taste. Of a similar form and size, but yellowish green, are the Rose Apples (*Jambos*, *Eugènia Jambos*). This fruit possesses a powerful odour of roses, and the same taste is imparted to the flesh; which, however, is somewhat leathery. If ever it were possible to improve this fruit by cultivation, scarcely anything, probably, could be found to excel it. The tamarinds (*Tamarindus indica*) are sufficiently known: the flesh, which contains free acid, is only used to make lemonade; but a particular use is made of the thin branches by the negroes, who are continually rubbing their teeth and gums with it, for which reason, these really handsome trees, can rarely attain their proper size near habitations. The bread-fruit (*Artocarpus incisa*) is not yet of any utility in the Brazils, the largest tree which I saw in Bahia was 30 ft. high; but on account of its large shining leaves, which are nearly  $1\frac{1}{2}$  ft. long, it is very ornamental. The fruit, which are like melons, scaly, and 4 or 5 lb. in weight, have been hitherto of little use. Much more important is the other species, which is called Jaca (*A. integrifolia*). The fruit attains sometimes the weight of 20 lb., and is covered with very prominent scales. The numerous bean-like, white seeds are surrounded by a fleshy parenchyma, which tastes sweetish, and is eaten by the negroes; it is also extensively used as fodder for cattle.

A very delicious fruit is the Cacao (*Theobroma Cacao*), which grows in Bahia, but not in Rio. It is as big as a lemon, and of the same shape, the seeds being surrounded by a very palatable and piquant rosy flesh. The Genipapa (*Genipa americana*) is apple-shaped, with a leathery brown skin: it tastes sourish, but is not much in use. Much more so is the Araça, or Guava (*Psidium pyriferum*); pear-shaped, and internally also resembling the pear; its reddish flesh is of a pleasant cooling taste. There are more sorts of Araça known: one is yellow, and of the shape of a very small Muscatelle pear; and the other is reddish blue, of a similar shape, which latter especially has a very delicate flavour; but both are rarely to be met with.

Besides the imposing majesty of the cocoa tree and the noble groves it forms about Bahia, the nuts are an important article of exportation; and I will add, that the yet liquid kernel (a real vegetable milk), refreshes wonderfully on these torrid shores. But not only these species of palms, but most of the others, are made use of, on account of some small portion of their seed. They form one of the petty luxuries of the negroes, and there are at least eight or nine species of such fruit sold in Rio.

This is, therefore, a list of Brazilian esculents and fruits, which, however, may admit of some additions in one or two instances, still forming the first outline of a *Pomona equinoctialis*.—The Brazilian, exempted from the influence of paralysing and torpifying severe winters, has no occasion for preserving or drying his fruits to any extent. Still, one economical use is made of them, and these are the preserves (*Doçe*), which are made especially of the *Araça* (*Guava*) and others, to a very great extent. They are prepared with the admixture of the white of eggs, most of them are quite solid, and sold in different shapes. They are the necessary addition to every Brazilian meal; and, as they are exceedingly cheap, and keep for a long time, they deserve to be made extensive use of during long sea voyages.

---

ART. XI. *On the Culture of the Mushroom.* By ALEX. FORSYTH.

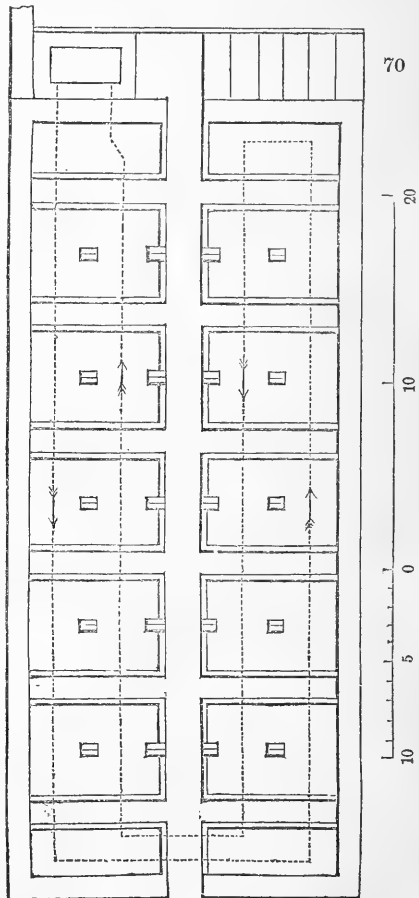
THE mushroom is an acceptable article at table all the year round; to supply this regular demand various plans are resorted to, and that which I have proved to be the cheapest and most efficient mode I shall here detail. By cheapness, however, I must not be understood to mean that false economy which short-sighted persons practise, of saving in the first outlay, and afterwards paying a greater sum, as it were, by instalments, or yearly rent, without an adequate return, or the possession of a creditable and satisfactory article. The culture of the mushroom, in many of our gardens, is an admirable specimen of this sort of economy. Instead of building workmanlike mushroom vaults (*figs.* 70, 71, 72.), with bricks, mortar, and cement, not subject to the dry-rot, nor to any other kind of rot, with the look and the reality of stability and usefulness, we find either ridges in the open air, covered with litter and mats, which must be taken off and put on at every gathering, or else, which is worse, the mushrooms growing in a shed behind the hot-houses, on shelves half-consumed with the dry-rot, and the wooden roof over head, as a matter of course, in the same predicament.

*Preparing the Spawn.*—Cake or brick spawn is the only sort that I consider worth making, and there is only one sort of materials that I think advisable to make it of, and these are, equal portions of horse-droppings, cow-droppings, and loam, well mixed, and pounded or beaten, adding just only as much water as will bring the materials to the consistency of brickmakers' moulding mortar. Then let a circular mould without a bottom, 9 in. in diameter and 2 in. deep, be placed on a table, with the wide end uppermost, and filled with this mortar and stroked level; before it is turned out of the mould, let three holes be made in each cake, with an iron-shod dibber,  $1\frac{1}{2}$  in. deep: the mould must be shaped like the frustum of a cone, that the cakes may easily part with it. When the cakes are all but hand dry, let them be spawned, by putting

a piece of spawn about the size of a pigeon's egg in each hole, enclosing it with a little of the original mortar. Then pile the cakes in pairs, with their spawned ends together, resembling a cask; and in this state let them be cased up in brick-shaped batches, and sweated and kept up to about  $85^{\circ}$ , by placing a layer of sweet dung all round and over the batch, varying it in quantity, to obtain the desired heat. The spawn must be examined as it runs in the cakes, and when one is broken and appears mouldy all through, and smells of mushroom, it is mushroom spawn in the highest state of perfection. To preserve it, however, it must be thoroughly dried in an airy loft, and kept dry for use. It will retain its properties for several years.

*To grow the Mushrooms.*

— Collect a quantity of horse-droppings, dry them a little in an open shed, then lay a stratum of loamy turf, 2 in. or 3 in. deep, in the bottom of the bed, and over this three layers of droppings, each about 2 in. deep, rendered as compact as possible, by giving each layer a good pummeling with a hand-mallet. When the last layer is made up, thrust a few "watch sticks" into the bed, in order to ascertain when it begins to heat. When the heat is getting pretty strong, let the bed be first beaten all over, then make holes with an iron-shod dibber, 9 in. apart, and deep enough to reach the stratum of loam: these will soon cool the bed; and when the heat has declined to about  $80^{\circ}$ , the holes may be bored by a conical block of wood, to about 2 in. in diameter, at 2 in. deep, in order to receive the spawn. These holes must be filled up, to about 3 in. from the surface, with loam and horse-droppings mixed; then insert a bit of spawn, about the

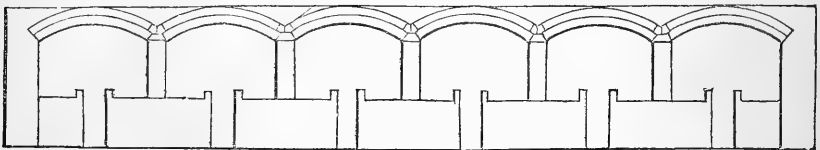


size of a hen's egg in each, and fill the holes up level with the surface, with the loam and droppings. The holes being closed, the heat will increase, and must be attended to: if violent, a few deep narrow holes may be made to let it escape; and, if too slight, it may be aided by a covering of dry hay, or a layer of warm dung; and when all danger of violent heat is gone by, and the spawn beginning to run, put on the upper stratum of loam, mixed with a little cut hay or dry horse-droppings to make a tough firm crust, about 1 in. deep. A temperature of  $55^{\circ}$  to  $60^{\circ}$ , I consider is best for the atmosphere in the house, and about  $90^{\circ}$  of bottom heat will set the spawn actively to work. The beds must not be allowed to get too dry, a layer of moist hay will prevent this; and, if too wet, a dry atmosphere can be got by gentle fires and open ventilators, which will aid them a little: but a bed once allowed to get thoroughly wet after spawning is, in my opinion, hopeless; and such a bed I should certainly remove without loss of time. Mushroom spawn, planted in loam and dung, or in either, and screened from sun and rain in summer, will produce this vegetable in abundance; and the same materials will produce the same effect, under favourable circumstances, in winter; such as being placed in boxes or baskets in a stable or warm cellar. In gathering mushrooms for present use, they may be cut; but, if they are to be kept a few days, they must be got with the stem entire. Half-dried droppings of highly fed horses, good spawn, and a gentle moist atmosphere, are the principal things to be attended to in cultivating the mushroom.

*Fig. 70.* represents the ground plan, which shows the size and shape of the beds and alleys, the piers for the arches, the boiler, and the direction of the pipes.

*Fig. 71.* is a longitudinal section, showing the kerbs of the beds, and the form of the stalls or arches.

71

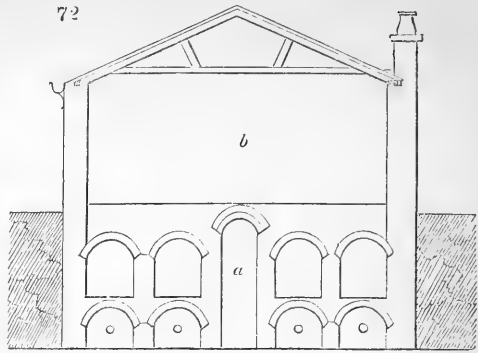


*Fig. 72.* is a transverse section, showing the arches under and over the beds, the thoroughfare *a* in the middle, and the position of the hot-water pipes: *b* is an open shed and general workshop; the receptacle for every thing requiring protection, too clumsy to be otherwise housed. A shed of this description is an indispensable adjunct to every well ordered garden;

and, in the present case, it serves as a roof to the mushroom-house. In the centre of each vault, shown in *fig. 72*., a circular ventilator, 9 in. in diameter, will be made, having a stone or cast-iron stopper, with a folding ring.

Cast iron shelves are objectionable in mushroom-houses, on account of the rust; and so are slate shelves, they being generally cold and damp, and, therefore, not suitable to the purpose; but I know of no objection to shelves built of bricks and mortar, and kerbed with hewn stone 3 in. wide, battled together with lead. Shelves have been executed in this manner at the seat of Sir Simon Clarke, East Barnet.

*Isleworth, Dec. 26. 1836.*



## REVIEWS.

**ART. I.** *Sertum Orchidaceum; a Wreath of the most beautiful Orchidaceous Flowers.* Selected by John Lindley, Ph.D. F.R.S., &c. Parts III. and IV.: Folio.

THE first and second parts of this splendid work have been noticed in our preceding volume (p. 148. and 287.); and the two before us maintain the high character of this publication, which we have before given.

Part III. commences with plate 11., a drawing combining singularity and beauty in an eminent degree. It represents three plants of *Leptotes serrulata* on a portion of the trunk of a cedrela tree. "This charming plant is especially remarkable for the sweet odour of the lilac which its flowers exhale. It is found in blossom in the month of December, on the trunk of cedrela trees, in the ancient Rocas of Brazil, where, without any sign of suffering, it survives the conflagrations that destroy so many other plants. The stems are cylindrical, creeping, and covered with a sort of dry smooth membrane, of a silvery whiteness, which spreads over a portion of the base of each leaf. The leaves are cylindrical, thick, succulent, fusiform, deeply channelled on the upper side, glaucous green or bluish, and dotted with violet purple, especially underneath. The flower-buds are of a yellowish rose colour, protuberant at their base. The flower is very large and stellate; the sepals are riband-shaped, rather broad, and white as the purest enamel; the petals narrower and thinner, but equally white. The lip has at its base two short rounded auricles; otherwise, it is strap-shaped at the base, with a white centre, whence there radiate numerous lines of the most brilliant lilac, and is afterwards dilated into an ovate pointed or lanceolate limb of a beautiful white."

Plate 12. is *Cyrtopodium punctatum*, already figured in the *Botanical Magazine*, and, consequently, included in our Floricultural Notices. The figure in the *Botanical Magazine*, however, Dr. Lindley observes, "seems to have been taken from a bleached specimen." Plate 13. is *Schombúrgkia marginata*, a Surinam species, from a drawing made in that colony, under the direction of

J. H. Lance, Esq. It has been introduced, but is now lost. (See Floricultural Notices.) Dr. Lindley's figure is truly splendid; the general appearance is "very like the Spread Eagle plant," which has not yet flowered in Britain, and which, Dr. Lindley adds, "may be a Schombúrgkia. Plate 14. is *Cymbidium élegans*, a native of Nepal, figured from a drawing belonging to the East India Company, and "corrected from dried specimens." The leaves are from 1½ to 2 ft. long, rising from a broad fleshy base or bulb. The flower-scape is about 18 in. long, pendulous; and the flowers are pale, yellow, nodding, and forming a close raceme. Plate 15. is *Aérides affíne*, a native of Sylhet, and figured from a drawing in the possession of the East India Company, "assisted by dried specimens." It has flowered in the collection of Messrs. Loddiges. (See Floricultural Notices, p. 138.)

Part IV. contains:—Plate 16. *Cynòches chlorochílon*, which will be found in our Floricultural Notices. Plate 17. *Saccolábium ampulláceum*, found on trees in the forests of Sylhet, which Dr. Lindley has described from Dr. Wallich's MS., is the copy of a drawing belonging to the East India Company. The stem is short and simple; the leaves distichous, thick, and spotted with purple on both sides (which is not, however, shown in the plate), and the flowers are in axillary racemes, much shorter than the leaves, and of a deep rose-colour. Plate 18. *Dendrobium cærulésceus*. (See Floricultural Notices, p. 137.) Plate 19. *Camaròtis purpúrea*, a beautiful and graceful climbing plant, with fragrant flowers, from the forests of Sylhet, figured from drawings belonging to the East India Company. The leaves are linear and coriaceous; the stem is two-edged, and the racemes of flowers straggling, ascending sometimes twice as long as the leaves; sometimes much shorter. Plate 20. *Stanhòpea Wárdü*, a splendid plant, which, being in cultivation at Messrs. Loddiges's, Mr. Low's, and in the garden of Mr. Barker of Birmingham, is included in our Floricultural Notices, p. 136. From examining the anatomical structure of this species, Dr. Lindley has arrived at the conclusion "that the varying tints of colour which are found in flowers are not produced by colours proper to the tissue of which they are composed, or by a confused mixture of colouring matter below the surface, but are caused by different colours, separately deposited in separate cells, which are themselves uniformly colourless."

---

ART. II. *Elenchus Plantarum novarum minusque cognitarum quas in Itinere Hispanico legit Edmundus Boissier*. Geneva, 1838.

THIS is the forerunner of a more ample and complete work, which the author has promised to give with illustrations, &c., of the results obtained by him in the course of four months and a half, which were spent in examining the botanical riches of the country between Gibraltar, the Sierra Nevada, and the shores of the Mediterranean; the diversified soil and elevation of which, ranging from the climate of Siberia to one nearly approaching that of the tropics, afford an ample and comparatively little explored field to the botanist.

This little list contains 200 species which the author considers to be new; out of more than 1800 collected by him, or seen in the herbals of native botanists who had studied in the same distr.ct. Roxas de San Clemente, a Spanish botanist, spent several years in exploring the same country, but the results of his indefatigable labours are locked up at Madrid; and, imperfect as we conceive the present work must necessarily be, it will be a valuable addition to our knowledge of the botany of Europe.

The author commenced his tour at Motril, a semi-African town at the very foot of the Sierra Nevada, near which the principal stream descends by a precipitous course to the Mediterranean. It is in the middle of the "Tierra

Caliente," or semi-tropical region of Spain, and on its vega, or plain, the sugar, cotton, cherimoya, and coffee are to be seen. For a district like this the 1st of April was rather late to commence; and, although on the whole the season from that date until the middle of August, which appears to have been that devoted to his tour, is the best for the purpose, we may easily imagine that some species must have been overlooked, which would have shown themselves had the observations been made during other periods. The principal part of the species were collected by the author: but he appears to have been assisted by M. Hantsler of Malaga, and a botanist called Rambur, whom we suppose to be of the same place; and he has had the advice and assistance of his illustrious countryman Decandolle in arranging his collections.

We have two valuable recommendations in favour of the work: one, the care with which the species nearest allied to the newly described ones are given, or their points of difference indicated; the other, the attention which has been paid to the elevation at which the plants were found, an invaluable point to every one, but especially so to those acquainted with this the most curious and interesting district in Europe.

We shall proceed to give a few of the more remarkable species of which the descriptions are full in the book, to which we must refer those who may be desirous of more detailed information, and more especially of those found at a great elevation.

We have five species of *Ranunculus*, of which the more interesting is a variety of *R. montanus*, very much like a species from Persia and Mount Libanus, found at an elevation of 8000 ft. to 9000 ft. on the Sierra Nevada. A beautiful *Pæony* was found at 5000 ft. to 6000 ft. on the Sierra Nevada and Tejada, nearly connected with *P. corallina* and *P. lobata*. The *Ptilotrichum purpureum*, a beautiful species near the *Alýssum*, was found on the Sierra Nevada at 8000 ft. to 10,000 ft. elevation. Another species, the *P. longicaulis*, was found to flower in August, though placed as low as 2500 ft., proving what we have already observed, that the period allotted is too short to give a complete flora. We have five *Heliánthema*, most of which appear to be mere varieties of well known species; but one, under the name of *Caput Felis*, is described as of uncommon elegance. A violet very nearly resembling *V. montensis* was found at 9000 ft. to 11,000 ft. A species of *Acer* under the name of *A. granatense* is given, which is allied to *A. monspessulanum* and *neapolitanum*, and was found at 5000 ft. to 6000 ft. A *Ulex* was found near Ronda, which appears to be a variety of *U. provinciális*, but differing in the larger size and form of the flowers. Two new varieties of *Cytisus*, and one of *Genista*, were found in the vicinity of Malaga; and a very elegant *Adenocarpus*, growing 15 ft. to 20 ft. high in the warm valleys of the Sierra Nevada, at 4000 ft. to 5000 ft. elevation, which would be a valuable addition to our shrubberies. Several extremely interesting genera amongst the other *Leguminosæ* were found at various altitudes; amongst others *Anthyllis tejedensis*, which forms beautiful carpets in the Sierra Tejada and Nevada, at 3000 ft. to 6500 ft. amid the limestone of those districts, the aridity of which few plants are able to brave. A beautiful *Coronilla* (*ericarpa*) was found in the same locality, nearly similar to *C. squamata* of Cavan. The *Hippocrèpis prostrata*, near to the *H. comosa*, was found at the foot of the precipitous rocks called the *Vacares* on the Sierra Nevada, 7000 ft. Of the *Rosaceæ*, *Prunus Rhamburei*, a variety of *P. spinosa*, was found amongst the deserts of the Sierra Nevada, 5000 ft. to 6000 ft. The *Potentilla nevadensis*, with yellow flowers, somewhat near *P. ambigua* and *P. geranioides*, was found very rarely in the fissures of the rocks near the summit of the Sierra Nevada, 9000 ft. to 10,000 ft. A new *Cotoneaster* (*granatensis*), resembling, but distinct from, *C. Fontanèsia*, occurs in the higher valleys of the same range, 5000 ft. to 6000 ft. *Cratægus granatensis*, an interesting tree, which is described as from 25 ft. to 30 ft. in height, and with a trunk almost the size of a man's body, was found in the valleys of the Sierra Nevada, where it was growing with *Lonicera arborea*, *Sorbus Aria*, *Acer granatense*, *Taxus baccata*, &c., 5000 ft. to 6000 ft. It is nearly identical with *C. heterophylla*, but is thorny, and has the leaves less smooth and differ-



ently shaped. The fruit is ovoid and pedunculated. An elegant species of *Sedum* (*rivuläre*) was found in the streams and moist meadows of the Sierra Nevada, 8000 ft. to 10,000 ft. The *Erýngium* *glaciäre* was discovered on the barren summits of the Sierra Nevada, 8000 ft. to 10,000 ft. *Bünium* *niväle*, a variety distinct from *corydälinum*, was found in the Sierra Nevada, at 7500 ft. to 9500 ft. *Reütera* *grácilis* and *R. procúbens* were gathered, the former at 5000 ft. to 6000 ft. the latter at 8000 ft. *Séseli* *intricatüm* was found on the Sierra Gatoza, where are the famous lead mines, and which is dry arid limestone, at 5000 ft. to 6000 ft. The *Heraclëum* *granatënsë*, a variety from *H. Sphondýlium*, inhabits the banks of torrents on the Sierra Nevada, from 4000 ft. to 6000 ft. *Butinia* *buniöides* was found in hollows and dry rocks in the higher parts of the Sierra Nevada, 8000 ft. to 9000 ft. We have two most interesting additions to our list of *Caprifoliäcæ*: the *Loniceræ* *spléndida*, an evergreen quite distinct from *L. impléxa*, to which it has the nearest affinity, which grows in the lower parts of the Sierra Nevada, and exhales a most sweet perfume; and the *Loniceræ* *arbörea*, which was found in the upper valley of the same Sierra, 6000 ft. to 7000 ft. The trunk is described as being  $1\frac{1}{2}$  ft. in diameter, and 25 ft. to 30 ft. in height, distinct from all others, but of the section *Xylósteum*. This most curious species, there is no doubt, is perfectly hardy, and might easily be added to our collections. Four new varieties and species of *Aspérula* are mentioned as being found at different elevations. Between thirty and forty species are added to the great family of *Compósitæ*, most of them being *Seneciönes* and *Centaurææ*. Of the *Campanuläcæ*, the *Jasiöne* *amethýstinus* was found on the summit of the Sierra Nevada, 8000 ft. to 10,500 ft. It is nearly allied to *J. hümilis* *Lois*. The *Gentiána* *Pneumonánthe* var., and *G. Böryi*, were found at 8000 ft. to 9000 ft. An elegant species of *Convólulus* (*C. nitidus*) grows in the arid limestone of the Sierra Nevada, 5000 ft. to 7000 ft. A species of *Lýcium*, distinct from *L. europæum* and *bárbaram*, was found along the shores of the Mediterranean, but rarely. A very elegant *E`chium* (*álbicans*) occurs in the arid mountains of Granada, from 2000 ft. to 6000 ft. A *Digitális* *laciniaäta*, a name improperly, as he says, conferred by his friend Hænsler, from whom he received it, inhabits the Sierra de Estepona, &c., 1000 ft. to 2000 ft. A variety of *Linària* *organifölia* *Dec.* was found in the Sierra Nevada, 9000 ft. to 10,000 ft.; and a beautiful species, resembling in leaves, but quite distinct from, *L. reticuläta*, is given as *L. Cleméntæ* from M. Hæntsler's herbarium. It inhabits the middle mountains near Malaga. The *L. glaciälis*, nearly related to the lovely *L. alpina*, was found but rarely in the states of the Sierra Nevada, 9000 ft. to 10,500 ft. *L. Ravéyi* inhabits Sierra de Tejada, 5000 ft. to 6000 ft. *Odontites* *granatënsis*, a new variety differing from *O. vérna* and *serötina*, was found on the Sierra Nevada, 6000 ft. to 7000 ft. The *Lavándula* *lanäta*, a variety of *L. Spica*, but distinct, was found on the mountains to 6500 ft.; the *Spica* on the lower grounds. The *Thýmum* *serpyllöides*, distinct from *T. angustifölius*, inhabits the higher parts of Sierra Nevada, 8000 ft. to 9000 ft.; another species, named *T. granatënsis*, inhabiting a lower elevation, 5000 ft. to 6000 ft. about which elevation two other species, *T. longiförus* and *T. membranäceus*, are also found. Six species of *Teucrium* are described, some new, and others already known, which inhabit an elevation pointing them out as desirable additions to our shrubberies. A *Quércus* is given under the name of *alpéstris*, why or wherefore such an appellation has been conferred we are not told; probably the author's remembrance of his native mountains may have been the cause. This species is from 20 to 30 ft. high, nearly allied to *Q. Pseudö-Süber* *Desf.*; it was observed in Sierra de la Nieve, abundant along with *Picea Pinsäpo*, at from 3000 ft. to 6000 ft. above the level of the sea. It was seen only in that locality, the elevation of which proves that it is hardy, and would consequently form a valuable addition to our ornamental trees. The pinsäpo has been too recently described to require more mention here. We shall conclude by noticing some grasses, of which fifteen species are described:—*Hólcus* *cæspitösus*, *Agróstitis* *nevadënsis*, *Trisëtum* *glaciäre*, *T. velutünüm*, *Festüca* *Cleméntei*,

*F. rivularis*, *F. indigésta*, *F. Pseudoéskia*, *F. élegans*, *F. granaténsis*, were found on the higher parts of Sierra Nevada, to 9500 ft.; and some others of the respective genera at lower elevations. *Aspidium nevadéense* was found on the rocks of the Sierra Nevada, at 8000 ft.

We have now to mention the strangest fact of all we find in this little work. Out of the number of new species enumerated, four are found\*: where? reader, can you credit? on the rock of Gibraltar! A spot a league in extent, which has been nearly a century and a half in our possession, and the botany never examined! It is absolutely a national disgrace that such a fact should transpire. We might apply to our successive governments a parody on the famous dictum of Oxenstiern: "Nescis, fili mi, quam parva *scientia* regitur mundus."

We have remarked on another occasion, the little use Gibraltar was made of, but as a fortress and smuggling depôt. The fact is, the whole country which this Swiss gentleman has so much to his credit examined, might and ought to have been explored years since from Gibraltar, where there is every facility of making excursions; the Spanish government would always give assistance, and the individuals are very much disposed to do every thing in their power. This tour has been made during the civil war, and the worst period. We earnestly hope that from Gibraltar some means may be taken to obtain the *Q. alpestris*, which we should beg to call *rondénsis*, the *Cratægus*, *Acer*, *Loniceræ*, *Adenocárpus*, &c.; all which may be obtained at the proper season with the greatest facility. — *S. E. C.*

---

ART. III. *The Genera of South African Plants, arranged according to the Natural System.* By Wm. Henry Harvey, Esq. 8vo, pp. 429. Cape Town, 1838.

FOR a sight of this volume we are indebted to our friend W. Christy, junior, Esq. It comprises a brief, but comprehensive, Introduction to Botany; a Glossary of Botanical terms used in the work; a Synopsis of a Flora Capensis, according to the Linnean System; and what occupies by far the greater part of the volume, an Arrangement of the Genera of South African Plants according to the Natural Method, as modified by Dr. Walker Arnott, in the seventh edition of the *Encyclopædia Britannica* now in course of publication.

In his Preface, the author informs us, that, being often requested by the admirers of flowers to recommend some introductory work on Botany, after various schemes had passed through his mind, it at last struck him, that a short Introduction, joined to a Flora Capensis, would best satisfy the wants of the colony.

"And it struck me also," he observes, "that by publishing now, thus showing that I was in earnest in my wish to undertake a Flora Capensis, it might be the means of introducing me to many persons interested in botany, and living in remote districts of the country, who might, perhaps, be willing to unite with me in amassing materials from which a future flora should proceed. That there are many such I am willing to believe: for it is hardly possible that a well educated person can have continually under his eye so many and such beautiful flowers as are scattered all over the country, without occasionally feeling an admiration of their structure, and a desire to learn something of their affinities and properties. A little sympathy and encouragement are often all that are wanting to make botanists of these. Intercourse by letter, and interchanges of specimens, foster the incipient taste, till it takes root downward, and bears fruit upward." (Pref. p. vi.)

"But I fear that many who might, from their position, materially assist the progress of botanical science, by making observations on, and collections of, the plants of their neighbourhoods, lie under the erroneous supposition that, because they have little or no knowledge of systematic botany, they are incapable of making collections or observations that can be useful to a

---

\* A Silène, a Brássica, a Cerástium, and a Thymus.

botanist. These should recollect that the greatest botanists are at best only students. There was a time when Linnæus and Jussieu were as ignorant as themselves, and would have continued so had they waited for intuitive knowledge. Sharp eyes and willing hands are the grand requisites for a botanical collector, and, if these be once set in motion, knowledge of affinities and structure will gradually follow as operations extend. Many of the most successful collectors of plants, by whose labours in all countries the science has been so extended and enriched, have been persons ignorant of, or but slightly acquainted with, botany at the time of their mission.

“There is one simple way in which all such persons may render important services, and by which they may gradually acquire the experience which they would fain possess at starting; namely, by collecting and drying specimens of the plants of their neighbourhood indiscriminately, without favour or affection, from the tall forest tree to the moss or the lichen on its trunk.” (Pref. p. vii.)

The general plan of this work is taken from Beck's *Botany of the Northern and Midland States of North America*, and Nuttall's *Genera of North American Plants*. The characters, arrangement, and restriction of the natural orders, are from the text of Dr. Walker Arnott, as already mentioned. The number of genera described is 1086, distributed under 133 orders, and the estimated number of species is 8500. The orders containing the greatest number of species are, Geraniaceæ 350, Diósmeæ 110, Oxalídeæ 110, Polygaleæ 100, Byttneriaceæ 100, Leguminosæ 700, Crassulacæ 300, Ficoidææ 500, Umbellíferæ 120, Compósitæ 1000, Campanulacææ 140, Ericacææ 450, Asclepiadææ 240, Scrophulariacææ 250, Verbenacææ 100, Proteucææ 200, Euphorbiacææ 100, Orchídeæ 150, Íridææ 300, Amaryllidææ 100, Asphodèleæ 450, Cyperacææ 160, Gramíneæ 160, Fílíceæ 150, Músci 150, Hepáticææ 100, Algææ 220. Of Lichènes and Fúngi there are no genera noticed, and of the other Cellulàres mentioned there are only 4 or 5.

In a note to the Preface, it is stated, that M. Zeyher dries and prepares collections of specimens for sale, at the moderate charge of 2*l.* per hundred species; and that collections for European subscribers will be forwarded to Sir W. J. Hooker and N. B. Ward, Esquire, who have kindly undertaken to receive them. We may add that Mr. W. Pamplin, junior, of Queen Street, Soho Square, London, successor to the late Mr. Hunneman, is a very fit agent for all matters of this kind.

We shall now glance over the natural arrangement, and note down any thing that we think may be interesting or instructive to the British gardener. Under Crucíferæ, we find a number of British annual weeds naturalised; and, indeed, the number of naturalised plants, introduced by the settlers from Europe incidentally, probably exceeds a hundred species, and in time will doubtless amount to thousands; for, comparatively speaking, all the annuals of cold countries will grow and perpetuate themselves in warm countries; as, indeed, will many of the annuals of warm countries in cold countries having hot summers.—*Viola arvensis*, an annual introduced from Europe, is a common weed in all cultivated grounds, extending even to Caffreland; and the mignonette is nearly so.—*Geranium*. The South African species are few and inconspicuous.—*Eròdium*. “Few and weed-like.”—*Pelargonium*. “This vast genus, the glory of the order, is almost exclusively South African. The species are very numerous and difficult to be defined, from the very great facility with which they form hybrids, running into innumerable varieties by seed. . . . Even in the field, the *Pelargonia* vary extremely, especially the tuberous-rooted species, and the greatest care is necessary to trace the forms to their common types, and note what characters are variable and what constant. When this shall have been fully done, (for the whole genus wants a ‘searching reform,’ and an extensive clipping,) I feel confident that the true species will be found to be very much fewer than authors generally state them.” (p. 42.)

*Oxalis*. A charming genus scattered over the globe, but reaching its highest

perfection in South Africa, where it abounds in species, and forms the ornament of winter and spring at the Cape. The leaves contain oxalic acid in various states of combination. "The species want revision and examination. The proportion between the styles and stamens, a character insisted on by authors, is of no importance, as it varies in the same species, or even in different flowers of the same specimen. This character being set aside, many supposed species fall to the ground." (p. 45.)

*Pittosporum viridiflorum* has the scent of jasmine, and must therefore be a very desirable green-house shrub.—*Diósma*. "A large and beautiful genus peculiar to South Africa, abounding in species, which are scattered extensively from one end of the colony to the other, and in many places so abundant as to impart a character to the vegetation. They are small shrubs, seldom above two feet high, much branched, &c." (p. 50.)

*Willemètia africàna Brong.* (*Ceanòthus africànus L.*) is not uncommon in gardens, and is found wild in the eastern districts.—*Phýlica*. "The foliage of many species is exceedingly pretty; especially those of the tribe of *P. plumosa*, the flowers of which are subtended by long feathery bracteæ, forming a beautiful plume at the summit of the branches."—*Virgília capensis* is a very common tree throughout the colony.—*Crotalària arboréscens*, the Cape laburnum, is very common in gardens, but not indigenous. *Melilòtus* is not a Cape genus, though three or four species are weeds in and near cultivated ground; among these are *M. arborea*, said to grow 15 ft. high in the neighbourhood of Constantinople, with stems nearly 3 in. in diameter. (See p. 300.)—*Trifolium*. The Cape species are few, and most of them plants of civilisation.—*Vicia sativa* is perfectly naturalised.—*Rùbus*. There are several wild species, many of them equalling or surpassing in the flavour of their fruit the best European species, always excepting the raspberry.—*Mýrtus*. "The discovery of the plants of this genus in Africa is a most interesting fact in geographical botany."—*Enothèra*. An almost exclusively American genus, but two species are naturalised at the Cape.—*Citrùllus*, the water melon. Two species, *C. cáffer*, and *C. amàrus*, are indigenous.—"*Sempervivum africanum Mill.*, a very doubtful plant, is the only Cape species enumerated. It is supposed to be the same as *S. arboreum*, a native of southern Europe and North Africa, and very common in gardens in this colony. All the other species are natives of Europe, or of the Canary Isles, Madeira, &c." (p. 120.)

*Mesembryáthemum*. An immense and truly beautiful genus of herbs or shrubs, with succulent leaves, and flowers of every hue, often intensely and dazzlingly brilliant. Almost all the species are South African, and Decandolle enumerates 316, which, however, comes considerably short of the reputed number; and our deserts probably still retain many more." The Celery and Parsley are naturalised in cultivated ground, as is the Fennel, the Lovage, and several other umbelliferous plants.—*Víscum*. There are several South African species of Mistletoe, and five or six of *Loránthus*. The latter "forms splendid draperies to the stunted acacias, with their large clusters of rich crimson flowers, and bright yellow-green leaves. Growing, as they do, in a wild and often parched country, few objects can be more refreshing or delightful to the eye of a traveller." It were to be wished that some of these species of *Loránthus* were introduced into British conservatories.

*Nàbea* Lehm. "This genus, named in honour of Mr. M'Nab, of the Edinburgh Botanic Garden, includes a single species, *N. montana Lehm.* a pretty shrub, with the habit of *Erica*, or rather of the European genus *Calluna* (heather or ling), with which it agrees in the dehiscence of the anthers."

*Erica*. Of this beautiful genus, between 300 and 400 species are described, the majority of them natives of South Africa, where, strange to say, they have no colonial name. All have very much the same general habit, being bushes with linear verticillate leaves; but they differ extremely in the shape and size of their flowers; some having large tubular corollas of the most brilliant colours, others small insignificant bell-shaped ones. In the memoir of Klotzsch in the *Linnaea*, vol. ix. p. 360., the species will be found described with great minuteness. (p. 212.)

*Técoma capénsis* grows wild, and is also a favourite garden shrub. — *Uncària Burch.* The grapple plant, so called from its hook-lobed fruit, is a most desirable plant to introduce into gardens; but though seeds have been sent to Ludwigsburg Garden, at the Cape, they have not yet germinated. — *E'chium.* The species are common wayside plants, and very ornamental. — *Nicotiàna.* The common and the Virginian tobacco are almost naturalised as weeds in cultivated ground. — *N. fruticòsa*, by some considered a native of the Cape, has probably been introduced from China. — *Datiira Stramòonium*, "the common thorn apple, an extremely virulent poison, is common in many places as a weed, but probably introduced by civilisation. It is equally wild in Europe, Asia, and America." — *Phýsalis pubéscens*, the Cape gooseberry, is "very common in the neighbourhood of cultivation, but is perhaps not strictly wild." — *Plantàgo lanceolàta*, the ribgrass plantain, "which has been introduced by Baron Ludwig, is admirably adapted, as Mr. Bowie informs me, for a permanent grass in our arid soil. It resists the greatest drought, and at all seasons presents a wholesome herbage." — *Atrapháxis undulàta* abounds on the mountains round Cape Town, flowering in January and February.

*Zàurus bullàta*, our only species, is a tall forest tree, whose fine-grained dark-coloured wood is much used in cabinetwork, under the unpromising name of "stinkwood," so called from the offensive smell of the fresh-sawed timber. When made into furniture, the better specimens have much the appearance of rosewood, and take a fine polish.

*Pròtea mellifera*, "the sugar-bosch, is a beautiful shrub, which grows 8 or 10 feet high, has glossy lanceolate leaves, and for 9 months in the year is covered with its large pink and white cup-shaped flowers, sitting in the axils of the branches. It often occurs in aggregate masses, covering, together with *Leucospermum conocarpum*, a whole hill-side: few plants can be more striking to the eye of a stranger."

*Brabèjum stellàtum.* A large and handsome tree, with fruit resembling a chestnut. "If prepared by soaking in water for some hours, it may be eaten, but, when fresh gathered, it is extremely deleterious."

"*Ricinus communis* (the castor-oil plant, or palma Christi) is common in this country, in India, and in North Africa; and perhaps Sprengel is correct in considering the other reputed species as mere varieties of this common one. Few plants are more affected by climate in development; what is in the climate of England a tender border annual becoming in the tropics, and even in this country, a tree continuing many years, and often reaching a large size." (p. 303.)

The oak, poplar, and chestnut are almost naturalised in most parts of the colony. — *Táxus latifòlia* produces the yellow wood. — *Sàlix gariépina* "is, according to Burchell, one of the greatest ornaments to the banks of the noble river whose name it bears." — Not a single species of *Abietíneæ* is mentioned as indigenous or naturalised in South Africa. — *Zàmia.* The colònia is *Caffer-broid.* — *Orchidàceæ.* The Cape genera belong to the two tribes *Vàndeæ* and *Ophrýdeæ.* — *Írìdeæ.* "The species are very numerous. They are not confined to any one district, soil, or elevation, but abound from one end of the colony to the other, covering the ground in the months of September and October with a sheet of blossoms, that resemble nothing so much as a shower of gaudy butterflies."

*Brunsvígia*, the "candelabra flower," is common on the flats in the summer months. — *A'loe.* This "is one of the great characteristic genera of the South African flora, though by no means equally distributed through the country. The species are most abundant in the Karoo Plains and the eastern districts, diminishing gradually as they proceed westward."

*Bowièa* Haw. "Two species are described, both discovered by Mr. Bowie (now curator of Ludwigsburg Gardens), after whom this genus has been named by Mr. Haworth, and who, by many years of patient labour in the interior of Southern Africa, during which time he enriched the gardens of Europe with a greater variety of succulent plants than had ever been detected by any

traveller, has amply earned any compliment which it is in the power of botany to confer. I am anxious to take this opportunity of expressing my own obligations to Mr. Bowie, for considerable assistance towards the present undertaking." (p. 347.) We are also happy to have an opportunity of publicly expressing our obligations to Mr. Bowie, for several valuable communications to this Magazine. We should be glad if he would add to them some account of the Ludwigsburg Gardens, now under his care. — *Lachenalia*. Mr. Harvey once met with a double-flowering variety, not unlike a double hyacinth in miniature. — *Juncus serratus* (Palmiel) is a noble plant, with tall, thick, trunk-like stems, surmounted by a dense crown of large, broad, serrate, channeled leaves, from the centre of which rises the much-branched panicle of flowers. — *Phoenix reclinata* is the only palm indigenous in South Africa. — *Zantedeschia æthiopia* (Cállæ æthiopia L.) abounds by waysides and water courses, where its flowers are conspicuous at almost all seasons. — *Typha latifolia* is common in wet places by the flats in water courses. It is given by Thunberg as a naturalised plant, but in Mr. Harvey's opinion unjustly.

This truly interesting work must have been one of immense labour to its author; but it has evidently been one that afforded him great delight; it is a valuable addition to our botanical literature, and will establish his name in all future times as a scientific botanist.

---

ART. IV. *Fifth Annual Report of the Jersey Agricultural and Horticultural Society for 1838.* 8vo, pamph. pp. 70. Jersey, 1839.

THE Jersey Society appears to be one of the most useful of its kind in any country. The first part of this report notices the progress made in the agricultural department; and here several farms are named as having been examined by the committee and found greatly improved. Liquid manure, in Jersey called "purin," is beginning to be collected by all classes of cultivators, from the cottager upwards, and is found "an invaluable manure, of easy transport, perfectly free from seeds or weeds, and, when judiciously applied to grasses, of astonishing value." The loss sustained by British farmers from allowing the liquid matters about farmeries to run to waste is incalculable; and even where liquid manure is collected and carried out to the field, its fertilising powers are not half what they would be if it were kept a sufficient length of time to undergo fermentation. This any person may prove on a few yards of grass land, or on a bed of onions or carrots; watering one half with recent liquid manure, and the other half with stale or fermented liquid manure. Draining generally, furrow draining or frequent draining, subsoil ploughing, soiling or yard feeding, and the saving and grinding of all bones, and the saving of all waste liquids whatever, are words which ought to form the text of every author who wishes to instruct his readers in the great secret of improving the agriculture of England as at present practised.

In the horticultural department it is particularly gratifying to observe the improvement which has taken place in cottage gardens. "The encouragement given to the cultivation of the small gardens belonging to cottagers, by judicious and liberal distribution of rewards, has produced an improvement among them which is evident to every one who frequents our markets; the supply of fruits and vegetables, as to quality, being from this source equal to the same products from the gardens of the rich proprietors; and, in the department of vegetables, the improvement is so important, that the market-gardener from England has frequent recourse for his supplies to the Jersey gardener. At the same time, the Board have the satisfaction to announce, that, while there has been an increased attention to this more profitable branch, there has been a marked improvement in the floriculture of the island.

"The Visiting Committee saw the gardens of several cottagers in the spring and autumn, and, according to their rules, took the opportunity of inspecting their cottages, and enquiring into their general domestic economy. It is with

much satisfaction the Board have to repeat this year their high sense of the improvement in cottage gardens in general, and that in all the instances there were a neatness and cleanliness in their dwellings which are the fruits of industry and good management."

That "spirited florist and nurseryman, Mr. B. Saunders, continues to increase his collections, and the Committee found his gardens in the best order, and tastefully arranged; and M. Rene Langelier has lately directed much labour and expense to a very extensive collection of pear trees. Since the Society was formed, several nursery gardens have been established, which of itself proves the increased encouragement given to the horticulture of the island." A vineyard has lately been planted by M. E. Nicole, jun. Among the objects for which premiums are given to cottagers are fowls of every description, including pigeons; to which might be added rabbits, pigs, and bees.

At the end of the *Report* is a list of plants indigenous to Jersey, made by Professor La Gasca while residing in that island, arranged according to the Linnæan system.

ART. V. *The Vegetable Cultivator; containing a plain and accurate Description of all the different Species and Varieties of Culinary Vegetables, with the most improved Method of cultivating them by natural and artificial Means, and the best Mode of Cooking them; alphabetically arranged: together with a Description of the Physical Herbs in general Use, &c.; also, some Recollections of the Life of Philip Miller, F.R.S.* By John Rogers. 12mo, pp. 343. London, 1839.

"EMBOLDENED by the success of a former work on fruits, which has reached a third edition, the author offers the present to a discerning public, in the hope that a similar success may attend it; and, while he would not attempt to undervalue other horticultural writings, he would yet venture to call attention to the circumstance, that few, if any, will be found to contain an equal amount of practical information condensed in the same compass, and at the same price."

Mr. Rogers's *Fruit Cultivator* was reviewed in a former volume, in which we noticed the great age of the author, to which he recurs in the concluding paragraph of his preface, thus:—

"Whether he shall himself survive long enough to find reason to be gratified with such success, his great age renders somewhat doubtful; but, if so, it will be pleasing to him to find that he has been useful in his day and generation; and, at any rate, he may be allowed to indulge in the reflection, that this has been his object."

Most sincerely do we wish prolonged life and health to this very worthy man. His book contains nothing but what is practical; and at the end there is a very interesting memoir of Miller. In this memoir we learn that Miller's father was a Scotchman, who, "after having lived for some time as gardener to a gentleman at Bromley in Kent, commenced business on his own account, as a market-gardener, near Deptford." Mr. Watts, one of Miller's men, informed us, some years ago, that Mr. Miller's widow told him that Miller's father was an Englishman; but, from the details into which Mr. Rogers has entered, we have no doubt of his correctness.

ART. VI. *The Journal of the English Agricultural Society.* Vol. I. Part I. 8vo, pp. 112. London, 1839.

THE origin of the English Agricultural Society will be found in our preceding volume, p. 181. It now appears to be firmly established, and this first

Part of its *Journal* is in every way worthy of such a body. The following are the titles of the papers which it contains:—

I. Some Introductory Remarks on the present State of Agriculture as a Science in England. By Ph. Pusey, Esq., M.P.

II. On the Selection of Male Animals in the breeding of Cattle and Sheep. By the Right Hon. Earl Spencer, President of the Society.

III. On Deanstonising, as distinguished from and compared with the furrow-draining and deep ploughing of the Midland Counties of England. By the Right Hon. Sir James Graham, Bart., M.P., F.R.S., &c.

IV. Report of several Operations in Deanstonising at Oakley Park, Shropshire. From the Hon. R. H. Clive, M.P.

V. Account of Subsoil Ploughing on a dry Soil, Heckfield, Hants. By C. S. Lefevre, Esq., M.P.

VI. Account of an Experiment on the relative Values of several Varieties of Wheat. By John Morton, Esq.

VII. On Gas Water as a Manure. By John Paynter, Esq.

VIII. An Essay on the Analysis of Soils. By the Rev. W. L. Rham, A.M.

IX. On the Progress of Agriculture in Scotland since the Formation of the Highland Society. By Mr. John Dudgeon.

Miscellaneous, including the rules and regulations of the Society, prizes offered, list of governors, list of members, &c.

In the first article the subject is handled both statistically and scientifically. After stating the gross produce of cultivated lands, and the average produce of wheat, the author says: "If by a better selection of seed we could raise this average produce from twenty-six to twenty-seven bushels per acre, we should add to the nation's annual income 475,000 quarters, which would be equal to a capital of twenty-four millions sterling, gained for ever to the country by a trifling increase in the growth of one article alone, and that in England and Wales only." We are sorry we cannot spare room to abridge this article, which is the most generally interesting of the whole. The next so is the last article, which may be designated A History of Agricultural Improvement in Scotland from the Commencement of the eighteenth Century to the present Time. It is exceedingly well drawn up, from the most authentic sources, and in part from the writer's own experience, he being a practical farmer in the neighbourhood of Kelso. The other essays are all more or less interesting and instructive; and, on the whole, Part I. of this *Journal* is a very favourable specimen.

We have more than once stated in this Magazine, that the farmers of England were the only class who did not read, and that till they became a reading class they would remain stationary as agriculturists. We are satisfied of the correctness of this opinion, from our own observation. In the year 1806, with a practical knowledge of the best farming in the Lothians, in Berwickshire, and Northumberland, we made a six months' tour in England and Wales, and we have subsequently repeatedly been in the same districts, and found no change whatever in the mode of cultivating the soil. The same cumbrous plough, drawn by three or four horses, with a driver going at a snail's pace, and turning up a furrow of 5 or 6 inches in depth, may now, as then, be seen in many parts of the country. The pockets of the landlords, however, for some years past have been sensibly touched, as, indeed, have those of all classes since the peace of 1815; the consequence of which is, that we have become a comparatively thinking people; with the single exception, we should say, of a certain proportion of the farmers, who are incompetent to derive improvement from reading and reflection. The *Journal of the English Agricultural Society* will induce many country gentlemen to become practical farmers; which will at once afford them a rational and profitable source of recreation, reform the practices of their tenantry, ameliorate the condition of farm labourers, and add to the beauty, and increase the agricultural produce, of the country. An immense deal, we think, will be gained by bringing the country gentleman in more close contact with his tenants and with country labourers. At present,



the gulf between the squire and the labourer is as that between Dives and Lazarus. We wish we could see every country gentleman holding the plough, sowing his own grass seeds, and pruning his own trees. We are convinced that this would add much to his health, happiness, and usefulness.

## MISCELLANEOUS INTELLIGENCE.

### ART. I. *Domestic Notices.*

#### ENGLAND.

*DIPLACUS puniceus* (*Bot. Mag.* 3655.) and *Petræa volubilis* (*Bot. Mag.* 628.).—Both these plants are now finely in flower here. *Petræa volubilis* is an old stove plant, the racemes of which are exquisitely beautiful. Indeed, I do not know a more graceful stove climber than this. It is not so gaudy as *Ipomœa Horsfalliæ*, but fully as desirable. The clusters of flowers are in the way of those of *Wistaria sinensis*, and something of that colour, but the flowers are didynamous (*Verbenacæe*). The starry calyx of each floret is longer than the petals; they are of a beautiful light or greyish blue, while the petals in the centre are of the most intense blue, with a small delicate white blotch at the base of the lower petal. They are produced on spurs of last season's growth, and the plant ought to be pruned like a grape-vine, in order to get these spurs distributed all over the plant. This delightful climber ought to be refigured in our modern works, in order to bring such a floral treat more prominently before the public. Compared with it, *Wistaria sinensis* is absolutely coarse.

The *Diplacus puniceus* will prove a "nice morceau" to afford a contrast by the deep scarlet tint of its blossoms. From the contrast these afford to the orange tint of *Diplacus glutinosus* (formerly *Mimulus glutinosus*), the hybrids raised from these plants may reasonably be expected to partake of the glowing tints of their parents, and to emulate in beauty those which have already been obtained between *Azalea coccinea* and *A. pontica*, which are of the same colours. Besides, the poor old *Mimulus glutinosus* has been almost neglected, because it refused to mix with its congeners, the herbaceous *mimuluses*; yet, when well grown, it is a very desirable plant, and I hope more attention will be paid to it, now that we have procured, through the exertions of our spirited nurseryman, a fit partner to it; and that the shrubby *mimuluses* will soon be as fashionable as the herbaceous ones. How far botanists are consistent in naming these species of *Mimulus* a separate genus is not for me to say, seeing that the genus is as good as many genera that we already possess; and it is of little use to trouble our heads with such nice distinctions, provided we get really good flowering plants, like the one now under consideration. I ought to add that Mr. Low's collectors procured twenty-five fine plants of the *Diplacus puniceus* in North America, but on the arrival of the box in November, 1837, it was found that every one of them had died on the passage. Mr. Low, however, succeeded in introducing it last season, and from him I obtained my plants. I believe it is in some other nurseries by this time; at any rate it must find its way soon into every nursery and garden.—*D. Beaton. Kingsbury Gardens, May 13, 1839.*

We observed at Mr. Low's nursery, on the 5th inst., one of the imported plants of *Diplacus puniceus* forming a very handsome shrub upwards of 4 ft. in height.—*Cond.*

*Kew Gardens, May 3.*—We scarcely ever recollect to have seen these gardens in better order, chiefly owing to the backwardness of the spring, and the dryness of the weather, which allowed the work of stirring and dressing the surface to be brought forward, while the growth of the plants and weeds was comparatively stationary. Though a great number of the half-hardy articles trained against the walls have been killed, yet the vacant spaces have been replanted, partly last year and partly during the present season, with other half-

hardy shrubs, which are doing remarkably well. A number of green-house plants have also been turned out into the borders, where they will make fine plants in the course of the summer, and may be taken up and repotted in autumn. Wherever there are green-house plants to spare, they cannot be used to better purpose than turning them out into the open borders or against walls; because, even if they live only one season, they form more rare, and consequently interesting, objects to the botanists than any other open ground plants whatever. The magnificent architectural conservatory was stocked with Australian and Cape shrubs about this time last year. They are all in boxes, tubs, or large pots, and they have thriven so remarkably well that they already appear rather crowded. The beauty of all large plants in a conservatory depends much on their isolated appearance, by which alone can be displayed their individual character; and, to produce this effect, they should never touch one another. Hence the great advantage of growing conservatory plants in boxes or pots, so as to admit of their being moved more or less apart from one another as they increase in size, or die down, or become mutilated by age or accident. This large conservatory forms a very handsome Grecian temple, externally, about three times as long as it is broad; but in the interior it is much disfigured by two rows of cast-iron columns without creepers or climbers around them, and which distract the eye in looking on the plants. The columns are just so far from the path as to be seen along with the plants, and, being painted white, they attract the eye more than the green of the leaves; whereas, had they been close to the path, the plants would have been seen between them, without interruption or distraction. A single row of slender columns along the centre of the house would have been quite sufficient to support the roof, and would not in the slightest degree have interfered with the effect of the plants; but even there they ought to have been so contrived at the base as to allow climbers to be trained round them. Some of the banksias and dryandras in this house are now in flower, and of singular beauty.

A number of specimens in the arboretum and in the botanic garden have been recently named with handsome cast-iron tallies. We suggested the propriety of this some years ago (see Vol. I. p. 352.; II. p. 315.; VII. p. 687., &c.), but it was not till Mr. Glenny took up the subject that our suggestion was carried into effect; a proof that with some minds something more than mere suggestion is required to produce action. This is a fact not very creditable to human nature; but it would appear that, in certain stages of the progress of society, abuse is more effective than fair words or sound reasons.

The opening of the Kent Zoological and Botanical Gardens, the progress of the Royal Horticultural Society's Garden, Structures at Stafford House under the direction of Mr. Hakewell, Mr. Corstein's Hyacinth Show, Mr. Groom's splendid Tulip Show, and a number of other matters, want of room prevents us from noticing at present. — *Cond.*

## ART. II. *The Garden of the London Horticultural Society.*

CIRCUMSTANCES prevented us from visiting the Horticultural Society's Garden this year till April 24., when we devoted the greater part of that and the two succeeding days to looking through every part of the grounds, and all the houses, pits, and frames, as far as they are shown to strangers. We never saw the grass and the gravel looking better, if so well. The walks are filled to the brim, firmly and smoothly rolled; and the edges are neither deep, nor showing a harsh line of earth between the grass and the gravel, as is too frequently the case, but shallow, while the leaves of the grass grow down, and come in close contact with the gravel. These, it may be said, are small matters; but they contribute much to the beauty and enjoyment of a garden; and their absence is almost always symptomatic of general bad keeping and want of taste.

In the arboretum a number of clumps have been thinned out, and the

ground laid down in turf; an obvious and very great improvement, which, in our opinion, ought to be extended to all the remaining clumps in that part of the garden.

The arboretum has been extended in the form of a belt, 45 chains and a half in length, extending along part of the east, through all the south boundary, and on the west and north through the interior of the garden. The average width may be about a chain (22 yards). A more definite idea may be obtained of the situation of this belt by turning to *fig. 73.* in p. 352., in which the belt occupies the following portions: A 1 and A 1 to the east of B 2 and A 2; A 3, A 3, A 3, A 5, and A 6.

The idea of extending the arboretum in the form of a belt is what we are sure every one will approve of; but, as there will necessarily be differences of opinion as to the manner in which this idea is carried into execution, we shall express ours on the present occasion, and leave the reader who examines the garden and our arguments to judge for himself.

Before, however, examining the details of this belt, we cannot help recurring to a recommendation which we have repeatedly given in this Magazine, viz. that before any part of the general plan of the garden is altered, that alteration ought to be indicated on paper, and submitted to the general examination of the fellows of the Society. Indeed, we have always stated that a plan ought to be drawn out and delineated, which should comprehend all the contemplated reforms; and that every alteration made should have reference to carrying this plan into execution. On such a plan the position of every tree and shrub intended to be planted, or, at least, to remain permanently, ought to be indicated, with as much care and exactness as the situation of all future walks, hedges, and buildings. One great object that would be gained by such a plan would be, the distribution of the trees and shrubs which constitute the British arboretum at such distances as could be afforded to each species and variety; adjusting such distances to the extent of the ground that could be spared for them, and to the normal magnitude of the tree or shrub. Now we admit that the extension of the arboretum in the form of a belt is an attempt at something of this kind; but it is evidently made at random, as all such alterations must be, unless they are previously laid down in a plan which shall comprehend the arrangement of the whole of the garden. For example, a certain space in this belt is devoted to the oaks, another to the horsechestnuts, and a third to the limes; but what evidence is there that there is a proportionate space left for the other genera and species of trees and shrubs? No evidence whatever, as far as we can learn, but the mere opinion of the parties concerned. We repeat, therefore, that before any alteration whatever is made in the Society's garden, a general plan ought to be laid down, which shall comprehend all contemplated alterations, even to the position of every tree and shrub. Such a plan is more particularly necessary for the arrangement of the arboretum, so as to give as much room as can be spared to each of the species. The present extension of the arboretum, without any definite plan having been laid down which has reference to the whole collection, we should consider discreditable in the case of any nursery or private garden; and it is evidently much more so in the case of a public garden, one object of which is to fit young men for holding situations as head gardeners.

We have before stated that we have no evidence that the proper space has been allotted to each genus; but we shall take it for granted that this has been the case. Supposing it to be so, we object to the commonplace mixture of extraneous trees and shrubs introduced among the kinds that are permanently to remain. This is done, we are well aware, to give the whole an ornamental and clothed appearance at first; but the grand object of the garden should never be sacrificed to appearances of any kind. In this belt, as at present planted, the trees and shrubs which are temporary, and put in merely to fill up, or clothe the ground, are much more conspicuous than those which are finally to remain; and they give to the whole, in the mean time, a sameness of appearance throughout, not different from that of the commonest shrubbery. The effect produced is said to be ornamental; but, to be truly so, a shrubbery

ought to contain variety as well as beauty ; and, to produce variety, one kind of tree or shrub should always prevail in one place, and another in another place, so as to create a difference in the different parts which compose the whole. Where this has not been done, the general appearance of the shrubbery or belt is the same throughout, or in other words monotony is produced ; and this we contend is now the case with that in the garden.

To combine an immediate ornamental effect with scientific arrangement and instruction the number of each species and variety of tree and shrub should have been increased, to such an extent as to clothe the ground, that is, five or six plants of each species or variety ought to have been planted together, instead of one ; the intention being to thin them out gradually to one, as the plants advanced in growth. Here would have been created a degree of beauty and variety the very highest that a belt or shrubbery is capable of producing ; and one, we will venture to assert, that every one that has the slightest knowledge of, or taste for, plants, would have been delighted to look on, and which would have left a lasting impression on all who have any taste for trees and shrubs. It will be objected to this mode of planting, perhaps, that some of the species could not be procured at all, and that others would have been too expensive. We admit that a few rare species of pines and firs could not at present be obtained in this country, but we assert with confidence that more than nine tenths of all the species and varieties of hardy trees and shrubs in the Horticultural Society's garden could be had from the London nurseries ; and we are of opinion that money would be much better spent in purchasing these than in building the new range of conservatories ; the money indeed that they would require would be, when compared to the cost of these conservatories, but a mere trifle.

The Horticultural Society, however, disapproves of this mode of planting, and has adopted the commonplace mode of indiscriminate mixture ; but even in this they appear to us to have been unfortunate ; for, by distributing certain conspicuous kinds of shrubs and herbaceous plants equally throughout the whole plantation, they have given it a sameness of appearance, that at the time we saw it, when the *Ribes sanguineum* was in flower, and the *Lupinus polyphyllus* in full leaf, appeared quite ridiculous. We are sure that, if such an effect had been produced in the shrubbery of a private gentleman, the gardener who planted it would have been reprimanded for it, and that most properly. To us it seems like a mockery or a defiance of the public taste. We have mentioned that the length of belt is in all  $45\frac{1}{2}$  chains (a thousand yards.) Will our distant readers, who have no opportunity of visiting the gardens, and who have paid some attention to ornamental effect, believe that, on one side of the walk through the plantation of this length, there are nearly equally distributed throughout 65 plants of *Ribes sanguineum* and an equal number on the other side ; that of *Lupinus polyphyllus* there are about 250 plants on each side ; and that the total number of plants of the genus *Ribes* in the plantation exceeds 460 ? The evergreens are chiefly common laurels, of which the number planted is 282 ; but, though we took the trouble to count the total number of trees and shrubs, we will not go further into detail. We only ask such of our readers as are in the habit of visiting the Horticultural Society's garden to look at this plantation, and reflect on what we have said respecting it.

It happens, unfortunately, that the portion of this belt on the west is so placed as to shade, and render in a great measure useless the east aspect of the fruit wall which formed the western boundary of the kitchen-garden ; and it also interposes between the sun and a range of glazed pits which have been recently formed against the south wall of the forcing department. All this shows the result of planless proceedings on the part of the garden committee. Two other objections to this belt, and we have done for the present. The first is, that the specimen trees have been planted on the flat surface, and not on slightly raised hillocks, as recommended in Vol. XIII. p. 156, and the excellent effect of which may already be seen both in Hyde Park and Kensington Gardens ; our suggestion having been immediately adopted by the Office of

Woods and Forests in planting single trees. The consequence of neglecting this mode of planting will not only be a want of beauty in the appearance of the trees, but a want of thriving, in consequence of the sinking down of the soil on which they are planted, and consequent burying of their collars by the levelling of the surface which necessarily follows to prevent the tree from standing in a hollow. This burying of the stem seldom fails to bring on canker in fruit trees, and every planter knows that it stunts the growth of all trees whatever. Our next objection is to a double thorn hedge planted as a boundary to this belt on the side next the orchard. We object to the boundary, as producing the appearance of confinement, and recalling to mind the confined walks in the belts of plantations, so admirably ridiculed by Price and Knight. But supposing that some line of separation were deemed necessary between the belt and the orchard, would not a single line of thorns have been sufficient? A single line is found to produce an excellent fence in Berwickshire, the first county for hedges in Britain. However, we merely mention this to show the commonplace careless way in which things appear to us to be conducted in this garden, by the garden committee.

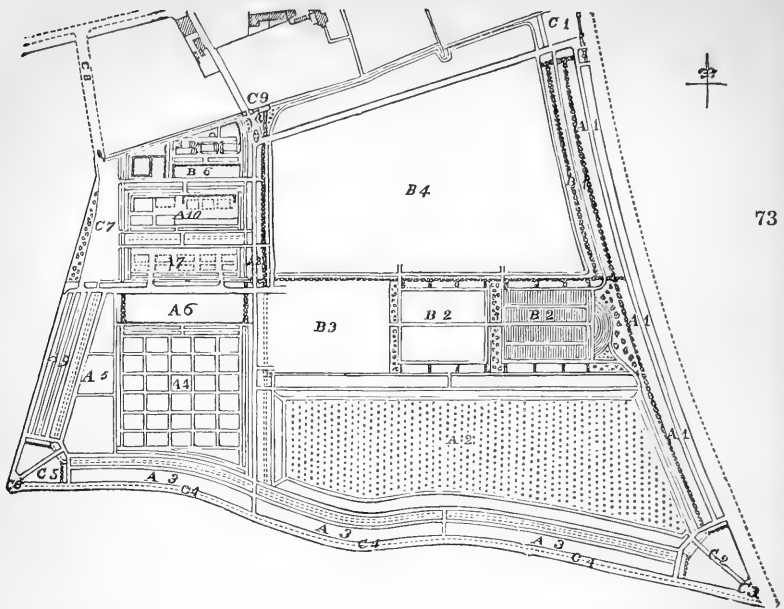
We have alluded above to the new conservatory which has been begun in the Society's garden, and, having never seen the plan, we wrote a letter to the secretary, requesting permission to see it, and to take a tracing for publication. The following is an extract from the secretary's answer:—

“As many points of detail in the construction of the conservatory are reserved until the erection of the outline shall enable us better to judge of the effect, no other than working plans and elevations have been made, and we are anxious that no plan should be published until the first wing is actually finished; the precise form of the central dome, which cannot be begun upon for the present, is left for future consideration.”

Under the above circumstances, we are precluded from making any remarks on the elevation or the mode of heating, the walks, whether the plants are to be planted in the soil or kept in pots or boxes (see what we have said on the plants in the conservatory at Kew Gardens, p. 348.); but we may be permitted to remark on the haphazard way in which the garden committee are going to work, by beginning to build a part before they have fixed on the design for the whole. At least this is the point of view in which the proceeding strikes us. We also object to the situation in which the conservatory is to be placed. We stated in our letter to the secretary, immediately after seeing the foundation, that we thought the site objectionable as being in one corner of the arboretum; because it must be recollected that the whole of what was originally the flower-garden is now laid down in grass and added to the arboretum. To our objection Mr. Bentham's reply is: “The site and direction of the houses were fixed when the conservatory was originally laid out, and the ground was left accordingly. I am sorry you differ so much from the whole of the committee on these points, but I would beg to observe that the site is very near the centre of the garden, and I cannot conceive how it can be said to be thrust into one corner even of the arboretum.” With due submission to Mr. Bentham, what was a valid reason when the flower-garden was kept distinct, and separated from the arboretum, cannot be a valid reason now that these two departments are united. If our readers will turn to the plan of the garden in Vol. VI. p. 250., and here repeated *fig. 73.*, they will perhaps better understand what we mean.

In that figure, B 4 is the arboretum, B 2 the flower-garden, and B 3 the site for ornamental glass. Now, as every person who has walked in the gardens, and will compare them in his mind with this plan, must be aware, the fences which separated B 2 and B 3 from B 4 are removed, and the whole thrown into one; consequently B 3 becomes a corner, and this corner bounded on the south by the fruit-shed at the back of the peach-wall, and on the west by another fruit-wall. This, we think, makes good our assertion, that the conservatory is to be placed in “a corner.”

The direction of the foundation is east and west, in consequence of which the plants on the north side will never look so well as those on the south



side ; and the house, as we think, will be more easily overheated in bright sunshine, and cooled when the wind is in the north. As far as we have been able to observe ourselves, and to hear the result of the experience of gardeners, a house with glass on both sides should always stand south and north, except in the three following cases: 1. when it is separated lengthwise by a wall or other division along the centre, in which case the north side may be kept at a different temperature and degree of atmospheric moisture from the south side ; as in the case of Messrs. Loddiges's camellia-house ; 2. when the house is of massive architecture, in which case, the effect both of light and of cold winds is moderated by the thickness of the columns or pillars of the sides, and the rafters of the roof ; and 3. when orchideous or other plants requiring constant shade on the south side are to be grown. We admit, however, the force of the following passage in Mr. Bentham's letter in answer to our objections :—" As to direction, it appears to me that the cold winds, which are seldom *due north*, are as likely to strike on an east as on a north side, and the inconvenience arising from the unequal distribution of the sun's rays must be much less in a house with glass on all sides, than in any other. Indeed I should think that the disadvantages you mention would be much less felt in an east and west house of this description, than in a north and south one ; whilst there are greater facilities in regulating the protection from sun on the one side and from cold on the other, and in the advantageous arrangements of the plants within side."

We reserve some remarks made by different correspondents on the expense of this conservatory, and the risk which they allege is being incurred of plunging the Society as deeply in debt as before, till a future occasion ; sincerely hoping that matters are not so bad as some assert them to be. We have now done what we conceive to be our duty ; we trust without giving personal offence to any one connected with the gardens, and with the chance of doing some good to a certain portion of our readers.

THE  
GARDENER'S MAGAZINE,  
JULY, 1839.

---

ORIGINAL COMMUNICATIONS.

ART. I. *Descriptive Notices of select Suburban Residences, with Remarks on each; intended to illustrate the Principles and Practice of Landscape-Gardening.* By the CONDUCTOR.

NO. 12. REDLEAF, THE SEAT OF WILLIAM WELLS, ESQ., F.H.S.

THE estate of Redleaf, near Penshurst, lies along the north side and in the bottom of a valley distinguished by the boldness of its undulations, the large proportion of the surface which is under wood and in pasture, the fortunate existence of a fine river, and the cropping out of some rocky strata. The whole surface of this part of the country appears, at no distant period, to have been native forest, or, at all events, under coppice-wood; and hence, in many of the fields, and in all the hedgerows, there are groups of oak trees, aged thorns, maples, and hollies, which give the face of the country the woody appearance of a park.

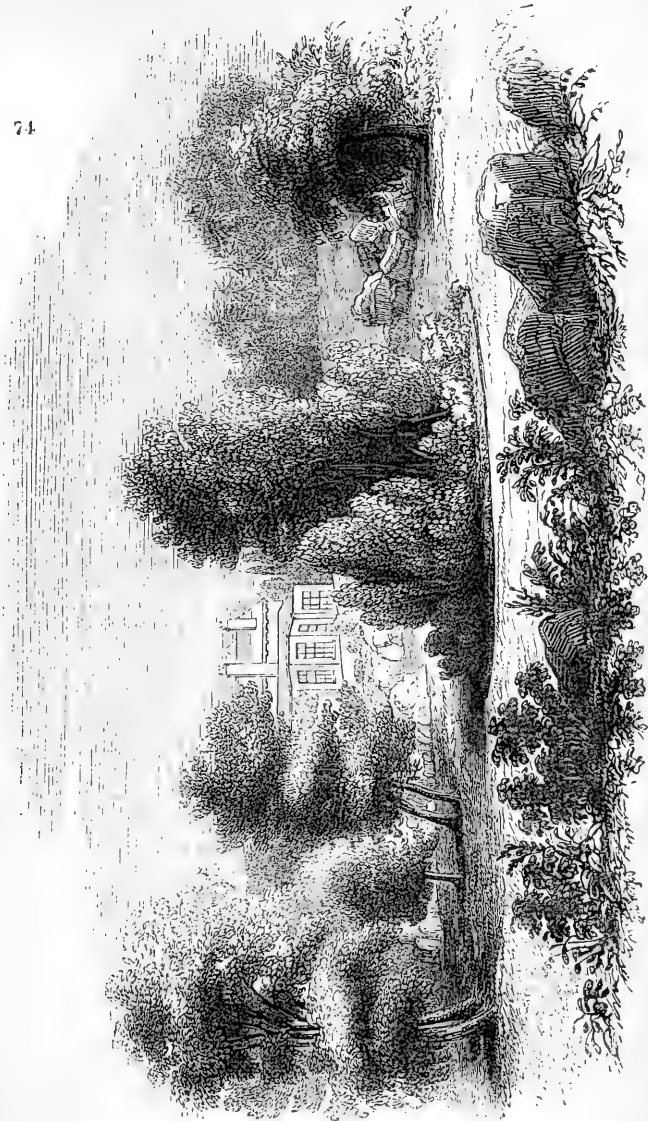
That portion of the estate which Mr. Wells has laid out as a residence occupies a steep undulating bank, facing the south-east, with a deep broad valley at one end, lying in the direction of north and south, and joining the valley of the Eden, a river which afterwards takes the name of the Medway, and joins the Thames at Sheerness. The road from London to Redleaf is one of great variety and beauty. Passing through Lewisham and ascending Bromley Hill, we have a general view of Bromley Hill Park; and, further on, we have a very striking descent, through a beech wood, to the vale of Seven Oaks. Near this town there are several seats, all more or less seen from the road; such as Chipstead Place, Chevening, Montreal, and Knowle; the latter being one of the most ancient baronial residences in England. From Seven Oaks to Redleaf, the road is comparatively private, passing through a wilder and more densely wooded country; the surface boldly undulated, and presenting at every step a change of scene.

The bold and varied undulations of the grounds at Redleaf, the fortunate disposition of the wood, and especially of the single trees and small groups, left very little for art to do upon a large scale. In some places, a field or a part of a field might

require to be planted, in order to form, add to, or connect, masses of wood; and, in others, a coppice might require to be thrown into pasture, and added to the park. But nature or accident had every where furnished so many trees in groups, that it became altogether unnecessary to plant; and hence there was no necessity for forming those heavy clumps by which so many places in every part of the country are disfigured. Another advantage of Redleaf is, that there is no marked boundary to the property; the mixture of wood, pasture, corn field, hill, and dale, being so much alike in general feature, in every part of the country, that it is utterly impossible for a stranger to tell where any man's estate begins or ends. Hence, there was no temptation to perpetrate that deformity which so often accompanies the clump, viz. the belt; a most unsocial plantation in a moral point of view, as shutting out all one's neighbours, whether poor or rich, and one which, as it regards pictorial beauty, generally destroys all harmonious connexion of the residence with the surrounding country. Mr. Wells's operations on the park scenery of Redleaf were therefore comparatively few, and not such as in any degree tended to alter the character of the place. He widened the river in one situation, and altered its direction in another, in order that it might be better seen from the windows of the house; he removed hedgerows, and laid down arable lands in pasture, so as to give extent and unity to the park or lawn; he added to or diminished the masses of wood, for the same purpose; and he formed a walk, so as to enable a stranger to make a general circuit of the place. These were the great features of improvement; and they have been executed with so much success, that a stranger, when he arrives at the house, and looks at the views from its windows, is so struck with the beauty and natural appearance of the scenery, that he cannot conceive that anything more is wanting to render the place perfect of its kind. But the most beautiful scenery in the world, whether the work of nature alone, or the result of nature aided by art, will soon cease to please, unless it bears marks of its appropriation to man, or can raise up associations of that kind. Hence, the tourist, who admires natural scenery in travelling through a beautiful country, endeavours to make it his own, and to let others know that he has done so, either by describing it in words which he can read to his friends, or which he can print, and thus publish to the world (thereby showing that he has as fully enjoyed the beauties of the scenery as if it were his own); or he commits the scenery to paper by a sketch, by which he seems also to appropriate it to himself. The purchaser of a portion of the finest scenery in the world never rests satisfied until he has done something to it; and it is not enough to do something, however great a change that something may have produced, unless it be



74



*View of the House, from a distant Part of the Rocky Lawn.*

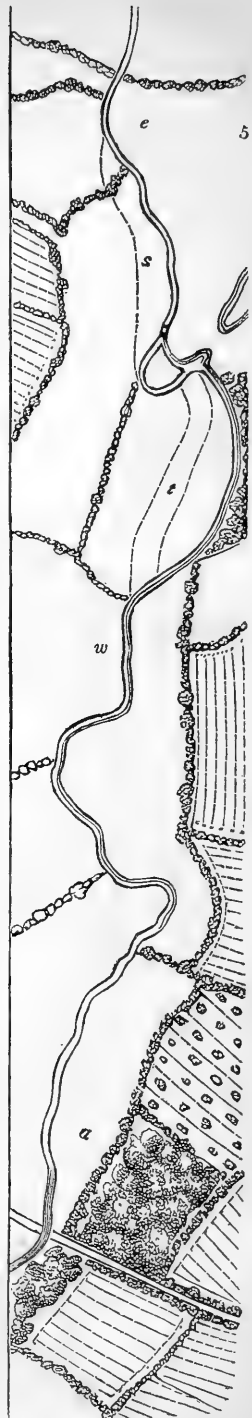
such as to be recognised by the rest of mankind. It is absolutely necessary that what is done should be discoverable as a work of art and taste. Hence, among purely natural scenery, some work of art must be introduced. Building is the common resource: but even a gravel walk, to show off the natural beauties of the scene, with seats or resting-places formed along it at proper points of view, will suffice. Admitting this principle to be

founded in nature, it is not to be supposed that Mr. Wells, after having improved the general scenery of Redleaf, would rest satisfied with admiring what he had done: on the contrary, having improved the natural beauties of the place, he immediately set about adding to them the beauties of art, by the formation of what may be strictly called garden scenery. Now, the great merit of Mr. Wells as an amateur artist is, that, while he has heightened and improved the natural beauties of Redleaf, he has been constantly employed, for the last thirty years, in creating artificial beauties there, which do not, in the slightest degree, interfere with the great leading natural features of the place. There are very few other proprietors who would not, while improving such a place as Redleaf, have done violence to the natural character of the place, by the evident intrusion of art.

Mr. Wells has obviously been guided by two principles; viz., first, that, in the views from the house, the natural character and expression of the surrounding country should be preserved; and, secondly, that all the garden scenes should be kept subordinate, or as episodes to the main features of the place. In order to preserve the general character of the country in the views from the house, it was necessary that the same character

*General Plan of Redleaf, previous to Mr. Wells's Improvements.*

- a b c* Shows the direction of the valley in front of the house, through which the river Eden winds from *a*, in the direction of *b c*.
- d d*, A broad undulating valley, on the north-west side of the house, which joins the valley on the south-west side of it.
- e e, &c.* The highest part of the grounds.
- f f*, Road from Seven Oaks to Tunbridge Wells, by Redleaf.
- g*, Cross country road from the Penshurst Road.
- h h*, Ledge of sandstone rock, rising several feet above the surface, 30 ft. or 40 ft. in width, and much weather-worn; presenting an appearance, at a distance, which reminds one of the surface of some parts of the Giant's Causeway; the rock having separated into polygonal faces, with chasms between, indicated by strongly marked lines.
- i*, Dwelling-house. *j*, Stable offices. *k*, Wood-shed.
- l*, Kitchen-garden. *m*, Farm buildings. *n*, Timber-yard.
- o*, Field barn and straw-yard. *p*, Cow-yard and shed.
- q*, Corn field. *r*, Coppice-wood to be removed.
- s*, Part of the river, afterwards widened.
- t*, New bed for a portion of the river.
- u u, &c.* Corn fields to be laid down in grass, and the separating hedges removed.
- v v*, Farm road to be removed. *w*, Situation of Penshurst Park

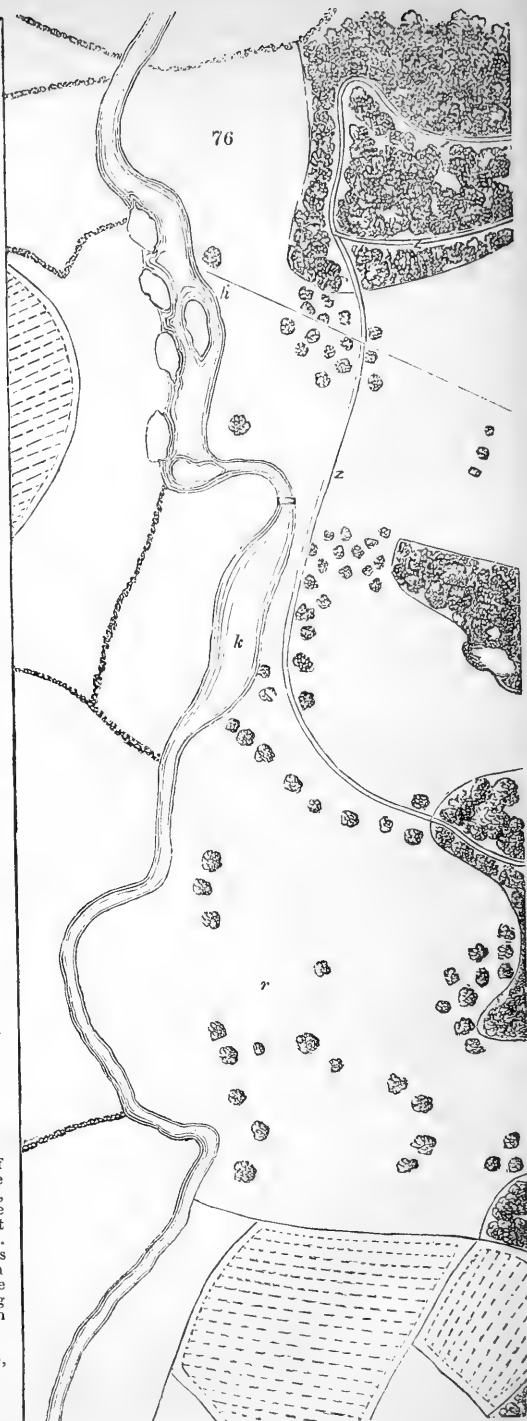


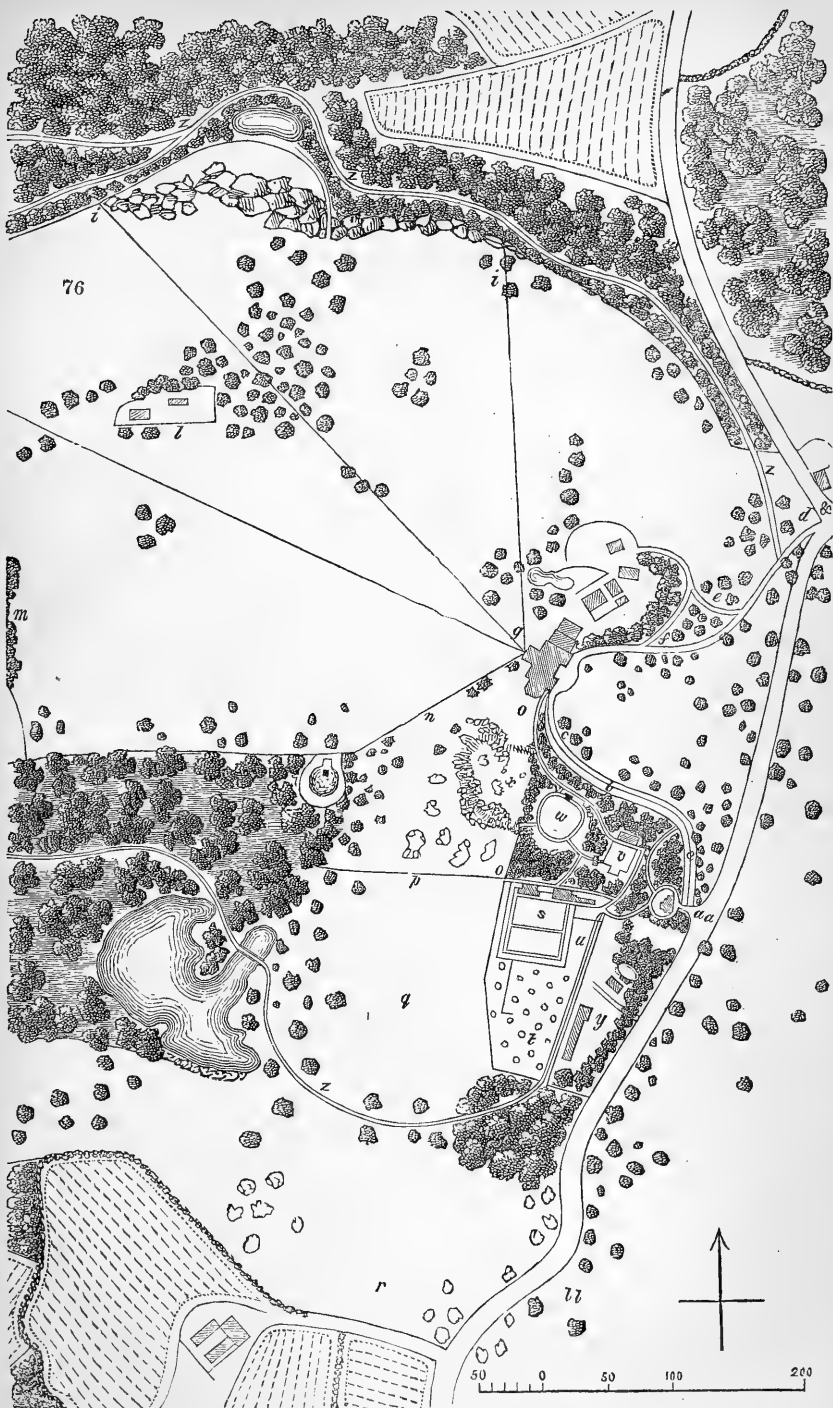


should prevail in the foreground which exists in the different distant parts of the scene; and, hence, no flower-beds are introduced immediately before the windows of the living-rooms. Something of this kind might, no doubt, have been done, though in a sparing manner, had Mr. Wells rebuilt the house, and surrounded it by an architectural terrace or basement; but, without such a medium for uniting the house with the grounds, flowers in the foreground, Mr. Wells judges, and in our opinion most justly, would have too powerfully attracted the eye. We must confess (such is the force of habit) that, the first time we saw Redleaf, we thought we felt the want of an enriched foreground

Plan of the Grounds at Redleaf, as they now exist.

- n*, Wire fence, separating the great valley pastured with sheep (*i l m*) from the mown lawn (*o*).  
*p*, Wire fence which separates the lawn from the sheep pasture (*q*), and from the cow-pasture beyond (*r r*).  
*s*, The kitchen-garden.  
*t*, The orchard.  
*u*, The frame-ground.  
*v*, The Dutch garden.  
*w*, The English garden.  
*x*, The rockwork garden.  
*y*, The farm-yard, timber-yard, &c.  
*z*, Walk forming the general circuit of the place. Along this walk are several seats and resting-places, open and covered, all of which, like all the other garden structures at Redleaf, were designed by Mr. Wells, and executed from his working-drawings by his own workmen. Some of these seats are formed round the trunks of living trees, as shown in *fig. 78*, of which *fig. 79* is a section.  
*g*, The London entrance and lodge.  
*aa*, The Penshurst entrance and lodge, of which a view is shown in *fig. 80*.  
*bb*, Part of Penshurst Park.

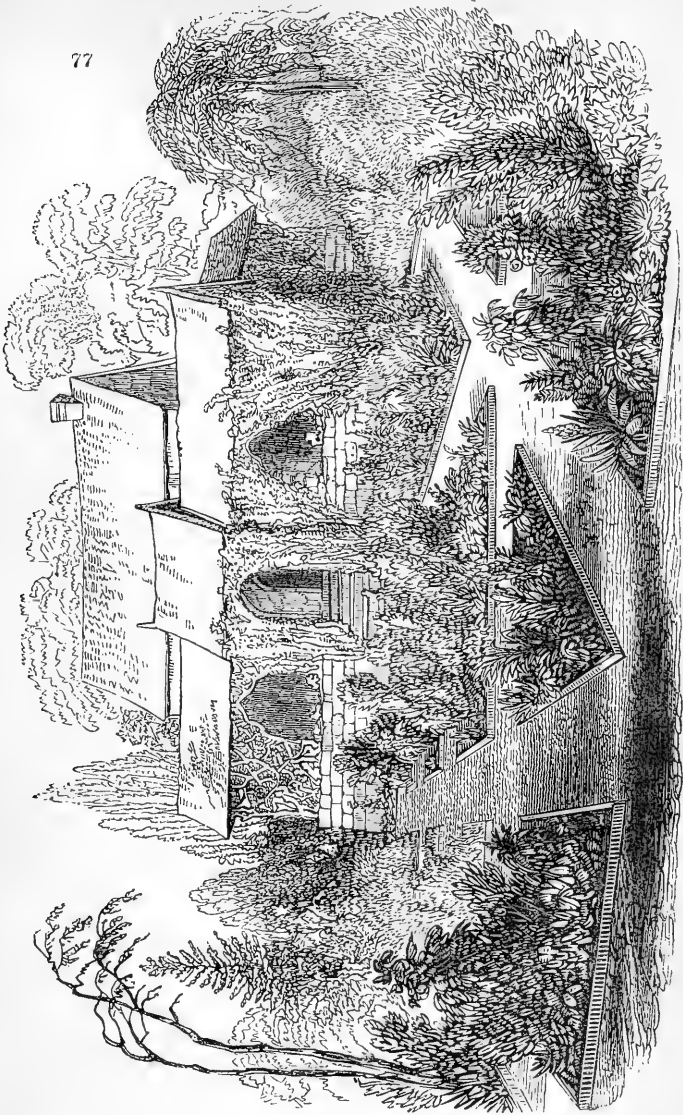




to the views from the house ; and another gentleman (the Rev. J. Mitford), a very eminent critic in all that relates to the landscape scenery of country residences, acknowledges that he had, and still has, the same feeling. On mature reflection, however, we are convinced that Mr. Wells is right, and that his taste is the purer of the two. Were Mr. Wells not as great an admirer of flowers as of pictures, and were his collection at Redleaf of the one not as select and excellent as that of the other, it might be supposed that he was so wholly absorbed in landscape, that he had no taste for flower-gardens ; but the reverse of this supposition being the case, proves to us that Mr. Wells's taste is the result of genuine correct feeling.

We must confess that it is sometimes a matter of difficulty to determine when a flower-garden should be laid out immediately in front of a house, so as to form a foreground to the distant scenery, and when it ought to be concealed or disguised. In general, this must be determined from the natural expression of the situation, and the views. When these are of a decidedly marked character, and make a strong and elevating impression on the mind, the introduction of a flower-garden in the foreground will interfere with this impression, and ought therefore to be avoided, or introduced in such a manner as to be altogether subordinate to the natural features ; but, on the other hand, when these features are bad or tame, and comparatively uninteresting, a flower-garden judiciously introduced will create an interest which was naturally wanting. For example, when the foreground is a flat or even surface, with little to vary it except trees and shrubs, and when there is no strongly marked feature in the middle distance, then beds of flowers, and flowering shrubs, form a valuable resource, and may render a naturally dull place gay and interesting. This is very well exemplified at Chevening near Sevenoaks, the seat of Earl Stanhope, where the foreground on the lawn front is an extensive flower-garden on an even surface, with a considerable piece of water bordered by lawn and trees in the middle distance ; and where the background is scenery of the same description, without the appearance of hills, or any marked feature, natural or artificial. At Eastwell Park in Kent, the seat of the Earl of Winchelsea, where the whole of the surface seen from the lawn front is flat and uninteresting, an extensive flower-garden is very properly introduced ; without which the views from the windows of that side of the house would have very little beauty. On the other hand, the lawn front at Linton Place in Kent, the seat of the Earl of Cornwallis, looking down on a steep descent, at the foot of which is a stream winding through a fertile valley, beyond which is an extensive and somewhat varied distance, flowers in the foreground would here escape notice ; or, if extensively displayed, would interfere with the strongly marked natura

77



*Restic Billiard-Room in the Dutch Garden.*

character of the scene. These may be considered as rules generally applicable, because they are founded on the fundamental law of the necessity of unity of expression to complete enjoyment; and this fundamental principle has evidently influenced the decision of Mr. Wells at Redleaf; but, as taste should be free, allowance must be made for that of individuals who may prefer having a peculiar and conspicuous feature in a

scene, to its picturesque beauty and unity of expression as a whole. In analysing the beauties or defects of every place, it is always instructive to be able to separate what is peculiar to the situation, or the taste of the individual, from what is general, or founded on universal principles.

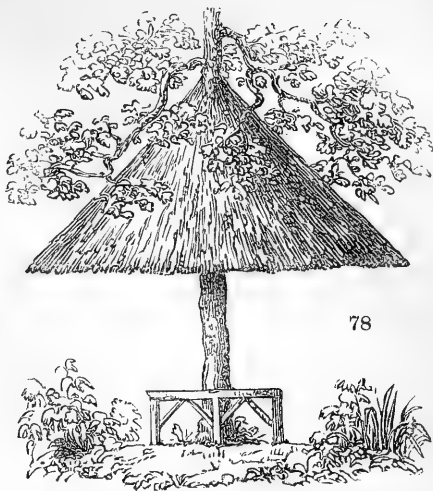
The garden scenery at Redleaf consists of a kitchen-garden, an orchard, an English flower-garden, a Dutch flower-garden, and an anomalous description of flower-garden, which may be called the rock-garden. This last garden constitutes by far the most singular feature of the artificial scenery of the place, and is totally different from anything else of the kind in England. The idea of forming it seems to have arisen from the existence of a ledge of rocks in another part of the grounds, and from the abundance of rock, of a kind easily quarried (red sandstone), under most parts of the surface. This part of the grounds at Redleaf is so original in character, that it is difficult to convey a correct idea of it without larger engravings than this work admits of; but we shall nevertheless make the attempt.

Before proceeding to describe the ground plans and views, we consider it useful to observe that the whole of the improvements at Redleaf, whether in altering the grounds, or in the construction of the buildings, were not only solely contrived by Mr. Wells, but all the working-drawings were made by him. The working-drawings, also, for some very picturesque cottages, and for a rustic conservatory, a rustic billiard-room, and various rustic seats, open and covered, were made by Mr. Wells, and have formed a source of amusement to him for many years, which was greatly heightened by the adaptation of the crooked branches and roots of trees to the architectural forms proposed. Recreations and amusements of this kind are, in our opinion, particularly suitable both for gentlemen and ladies who live on their country seats. We would have the ladies, like Lady Grenville, design all the garden structures, and the gentlemen study the improvement of the farm and other buildings necessary for the general business of the estate.

*Fig. 76.*, in p. 358, 359., is a plan of the grounds at Redleaf as they now exist, exhibiting Mr. Wells's improvements. On comparing this plan with *fig. 75.* in p. 356, 357., the principal alterations made by Mr. Wells appear obvious at first sight. One of these, essential to the beauty of the place, is the plantation made in the direction of *a b c*, in *fig. 75.*, parallel to the approach from Penshurst. Without this plantation, which is chiefly of evergreens, the eye of the stranger arriving from Penshurst would have seen all the natural beauties of the grounds before entering the house; because the ground slopes from that line of approach on the left towards the valley, and rises on the right towards the public road. The same thing would happen to a stranger arriving by

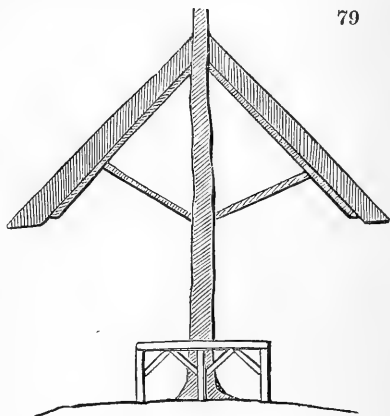


the London approach, were not the trees disposed along it in the direction *d*, *e*, *f*, which shuts out the great north-western valley, except near the entrance approach; where the eye may detect between the trunks of some large trees just as much of the commencement of the valley as to set the imagination at work to guess its extent. As the wood is now disposed, the stranger, whether he arrives from London by Seven Oaks, or from Tun-



bridge Wells by Penshurst, drives up to the house, admiring the finely scattered groups of oaks, thorns, and hollies, on the rising grounds on one side of the approach, without being aware of what is concealed by the plantation on the other side. Entering

the house, from the bay of the drawingroom at *g*, he is struck with astonishment at the extent of the prospect, and at the fine reach of the river at *h*; beyond which, up the valley, he can see nearly as far as Godstone, where some trees on the summit of a hill above that town mark its situation. If, from the centre window, he turns his head to look through the window on his right hand, he sees the whole range of the Redleaf rocks; and if he

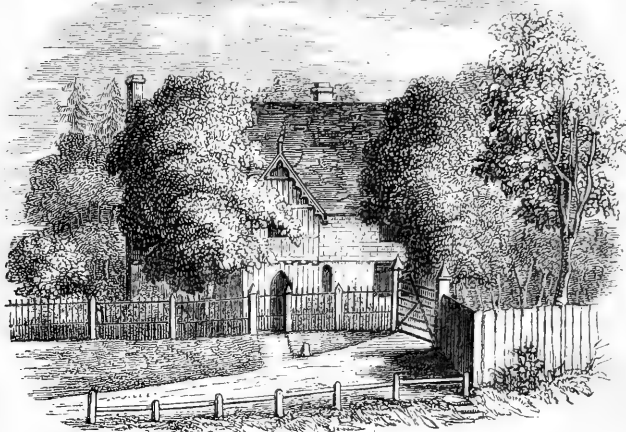


turns to the left-hand window, he sees another reach of the river appearing beyond a wood. The surface of the water of the river is probably 200 ft. below the level of the drawingroom floor from which it is seen; the chain or causeway of rocks, *i i*, 100 ft. below it, and the cottage *l*, and wood *m*, rather lower.

The effect of the woodman's cottage at *l*, which may be described as one of the aboriginal cottages of the country, is exceedingly good, as seen from the drawingroom, by the strong contrast which its humble appearance and the associations connected with it, afford to the richness and high art displayed in

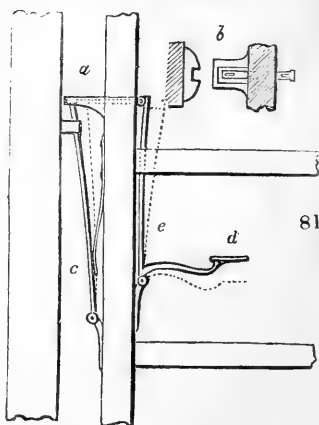
the house. In this extensive view, no gentleman's house is to be seen, no church, and scarcely a farm-house or cottage, so completely are almost all the objects of art concealed by the hedge-row trees. In winter, after the leaves drop, are to be seen some human dwellings, and two or three churches.

80



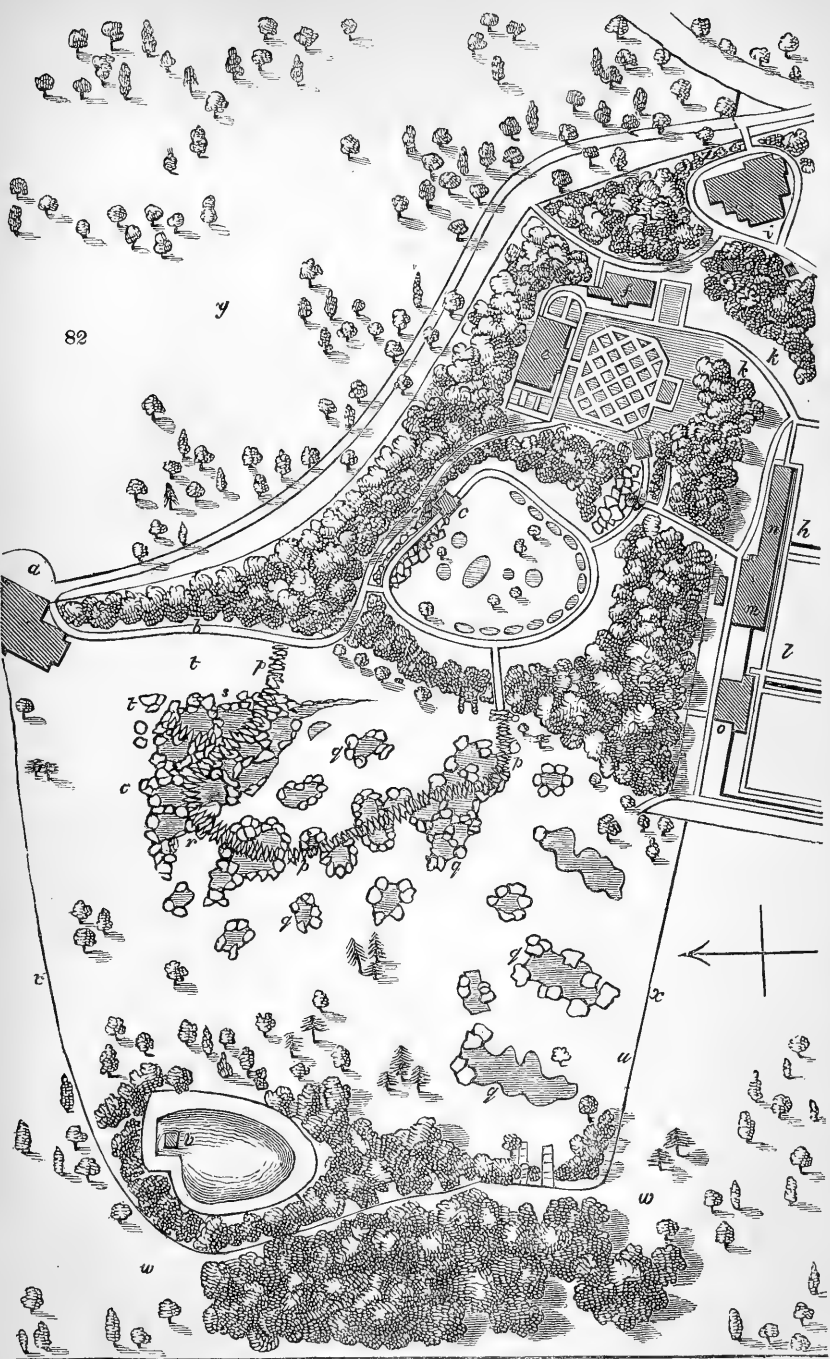
*Penshurst Entrance Lodge and Gate.*

The gate fastening at the Penshurst Lodge (*fig. 80.*) is somewhat peculiar in construction; but, by those familiar with different kinds of gate fastenings, it will readily be understood from *fig. 81.*, in which *a* is a side view, and *b* a transverse section. The upright latch *c* is held in the catch by a spring, so that it cannot easily be shaken out by the rubbing of cattle, or the shaking of boys, or idle persons; while it can be easily opened by a person on horseback, placing the end of his whip or stick in the hollow thumbpiece (*d*), which, acting as a lever on the upright piece, *e*, pulls back *c*, and compresses the spring, by which the gate is readily opened.



From the plan *fig. 76.*, as compared with that shown in *fig. 75.*, it will be seen that the corn field *q*, in the latter figure, is planted and the coppice-wood at *r* removed; but the most important features of improvement are, the widening of the river at *s*, and the altering of its bed at *t*, as indicated by the dotted lines in *fig. 75.*

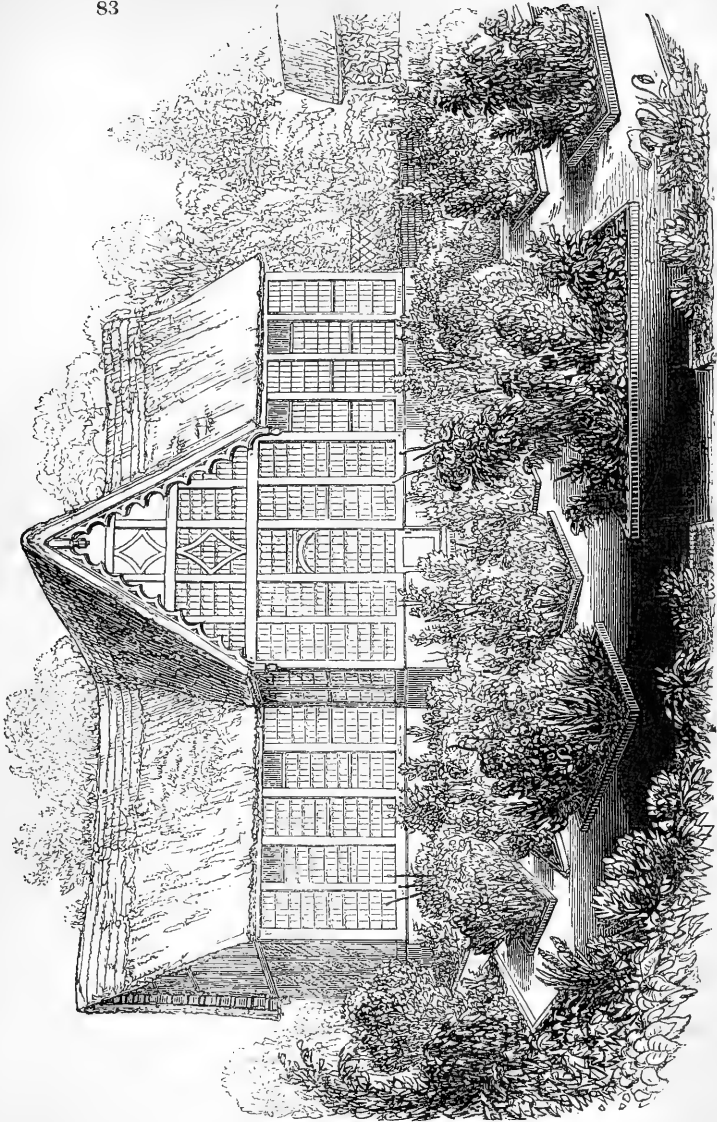
*Fig. 82.* shows a plan of the lawn and flower-gardens at Redleaf, on a larger scale.



- a*, A portion of the house.
- b*, Walk from the house to the garden scenery.
- c*, Summer-house in the English garden. This structure, of which a view is shown in *fig.* 84. p. 369., is placed on a ledge of rock, which, before the garden was made, formed one side of a stone quarry; hence, immediately beneath this summer-house there is a very considerable hollow. The rest of the flower-garden has an undulating surface, and the beds are chiefly oval or circular. Among the single low trees are two specimens of the common berberry, which, trained to single stems, form very handsome objects. They are profusely covered with bloom in spring, and, in autumn, so completely clothed with their long red fruit, as to resemble, at a short distance, gigantic specimens of scarlet fuchsia. The rustic structure is curiously and exquisitely executed of different kinds of wood, but chiefly of oak with the bark removed, and of hazel. The floor is paved with oak chumps; and there is a table inlaid with different kinds of native woods; and chairs, as well as a bench, chiefly formed of hazel rods.
- d*, Continuation of the walk *b*, on the top of a ledge of rock still higher than the walk which passes through the summer-house (*c*). The walk *d* conducts us to the Dutch garden, the buildings in which are an orangery and rustic billiard-room.
- e*, An orangery constructed of oak, placed on a basement of rustic masonry, and thatched with reeds, of which *fig.* 83. is a view.\* It is placed in the north side of the Dutch garden, some of the rhomboidal beds of which may be seen in the engraving. In this orangery there is a space in the centre, which is occupied as a sitting-room, and is furnished with chairs, tables, &c., for eating fruit or taking tea. From this scene there is a door to a Chinese dairy, richly fitted up with Chinese porcelain, many of the specimens of great size, and exquisitely painted. Amongst the flowers, we observed the blue tree peony, an imaginary variety of the Chinese, but one which never can be found in nature, since it supposes one primitive colour to be changed into another, which never takes place in flowers. Corresponding with the dairy is a small room over the stoke-hole, with a fireplace. The dairy is not used as such, but is merely to be considered as a collection of Chinese dairy porcelain. This conservatory, having a thatched roof, and being in a situation sheltered from high winds, requires very little artificial heat, even in the most severe winters. It is used to protect orange trees, large myrtles, and such green-house plants as are in a comparatively dormant state during our winters. In summer, most of the plants are turned out, and others brought from the green-houses and forcing-houses, as they come into flower; it being found that in this comparatively cool and shaded house the bloom is retained much longer in perfection than it otherwise would be. We remarked here some orange trees, lemon-leaved myrtles, and camellias, which had not been turned out into the open air for several years; and, though the young shoots were etiolated to a considerable extent, yet the intensely dark green of their leaves appeared to show that shade was more favourable to them than sunshine. The thatch, being of reeds, has a handsome appearance.
- f*, A billiard-room, with a rustic veranda, also placed in the Dutch garden, and

---

\* The sketch from which this engraving was made was taken in November, 1837, on a very rainy day; which is the reason, we suppose, that the draughtsman has made a slight inaccuracy in the windows, by making the panes of glass parallelograms, instead of long octagons, which have a much better effect. *Figs.* 77. and 84. were taken at the same time, by the same artist; but all the other engravings given to illustrate this article have been made from sketches taken in June, 1838, in fine weather; and their accuracy may be depended on.



Rustic Orangery in the Dutch Garden.

of which *fig. 77.* in p. 361. is a view. It is raised on a rustic stone basement ; and the veranda, which is returned at the angles, is paved with oak chumps, and forms a most convenient place for taking exercise in during rainy weather ; a use which harmonises well with that of the billiard-table, which, to an amateur gardener, is chiefly valuable as affording him salutary exercise when he cannot be at work out of doors.

All the walks in the Dutch garden are paved with white brick, and edged with stone ; and, as they have all a gentle inclination so as to throw off the rain

rapidly, they are better adapted than any other description of path for walking on after a shower; thus permitting a lover of plants to examine them in one of the most interesting states in which they can be seen in spring and summer, that is, when just revived by a shower, and while yet covered with drops of rain. The beds are planted with a very choice selection of herbaceous plants, perhaps unequalled in the country for combining compactness and neatness of growth with beauty and rarity. The walks are  $2\frac{1}{2}$  ft. wide, and the beds 6 ft. wide; so that any person can reach from the margin of the bed to the middle without putting a foot on it. The space beyond the circumferential walk is planted with a collection of all the best azaleas; not crowded together in one mass, as collections of this shrub and rhododendrons commonly are, but in distinct bushes, so that each is covered with flowers from the ground to the summit on every side. To insure this gardenesque appearance, the plants are taken up, reduced, and replanted in fresh peat soil, as soon as ever they begin to grow out of bounds. To this practice, our attention was first directed by the late Rev. Thomas Garnier (see Vol. X. p. 126.), who followed it with all his American shrubs, and, indeed, with his roses, and with all his shrubs that were valuable for the beauty of their flowers; and it cannot be too strongly recommended for imitation.

g, An aquarium, on the margin of a bank of rockwork, of which *fig. 90.* in p. 375. is a view, which extends from the English garden nearly to the Dutch garden. The walk connecting these two gardens, and also a branch from it to the conservatory and kitchen-garden, are covered with an arcade of creeping shrubs, sufficiently open on the sides to admit a view of the bordering plants, which are all of the more rare and beautiful kinds. There are here, also, various *sanctums*, and minor compartments for small plants, not shown in the plan; and also a large space for setting out the green-house plants during summer.

h, Experimental garden. Here seedlings of various ornamental plants, such as dahlias, heartseases, herbaceous calceolarias, picotees, polyanthuses, &c., are reared till they come into flower; when the more beautiful sorts are selected, and the rest thrown away. It was in this garden that the first dwarf dahlias were raised by Mr. Joseph Wells, Mr. Wells's gardener, in the year 1825.

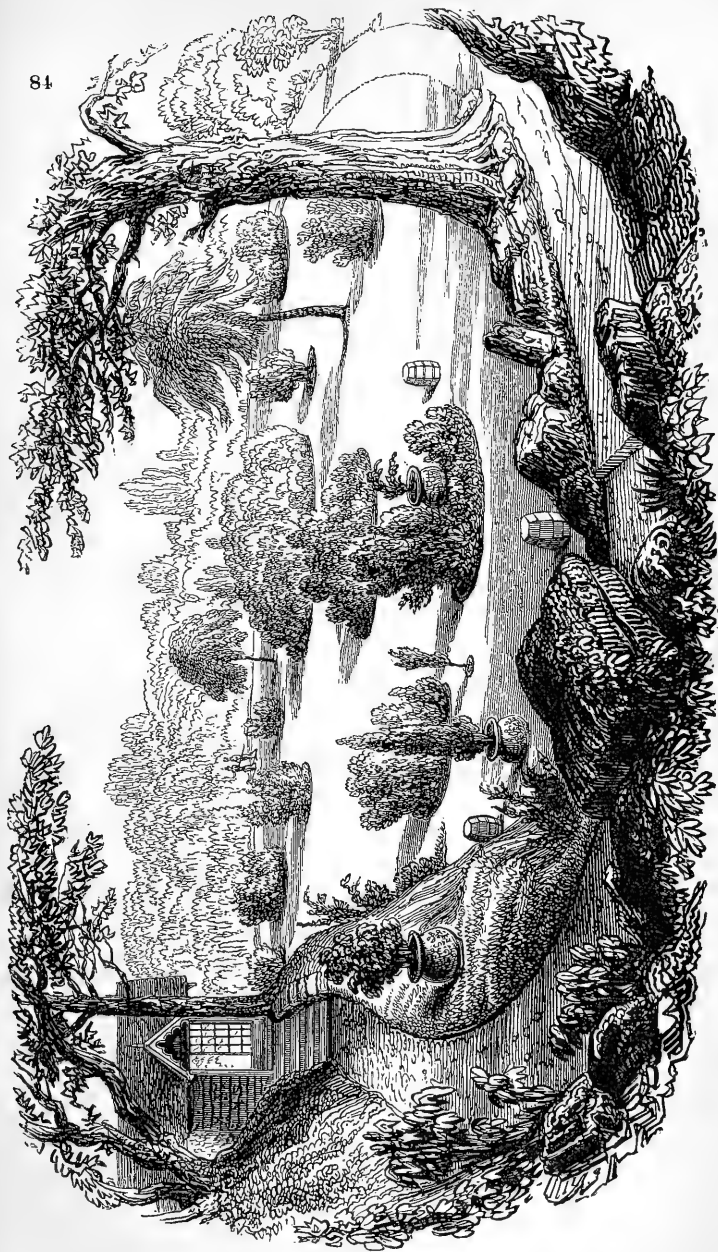
i, Gardener's house, which serves, also, as a lodge to the Penshurst entrance, of which *fig. 80.* in p. 364. is a view.

k k, Borders of azaleas, rhododendrons, and other American flowering shrubs

l, Kitchen-garden.

m n, Conservatories and green-houses. In one of the conservatories, there are some remarkably large and luxuriant specimens, particularly of *Wistaria sinensis*, the Madras citron, *Clíanthus puníceus*, and *Enkiánthus quinqueflórus*. In an adjoining conservatory, the back wall is covered with camellias, which are not trained in close to the wall, like fruit trees, but have their young shoots projecting out like a camellia hedge; and the intensely dark green of their leaves, and the profusion of flowers which they produce under this treatment, show how well it is adapted to them. In general, it may be observed that these conservatories exhibit the true kind of beauty which a conservatory ought to produce; viz., free, luxuriant, and seemingly uncontrolled growth; presenting every where a picturesque appearance; and directly opposed to the beauty of the green-house, in which the plants are kept in pots on stages, and in which trimness, neatness, and the close training of climbers (in a word, the gardenesque), ought every where to prevail. It may be useful, both to amateurs and to gardeners, to bear in mind these distinctive characters of the conservatory and the green-house. The orangery presents an aspect somewhat different; because the plants, instead of being in small pots on stages, are in large pots, boxes, or tubs, and, for the most part, placed on the floor: but still the arrangement of the interior is every where guided by the principles of the gardenesque.

84



English Garden and Summer-house.

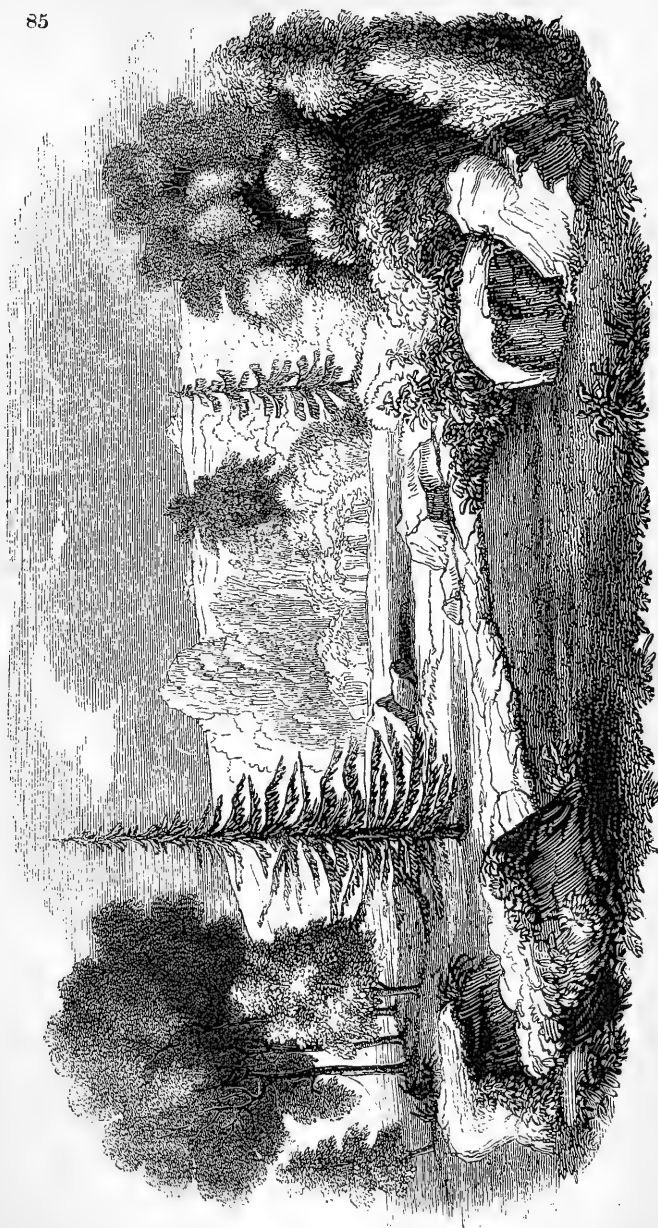
- o, Vinery and plant stove.
- p p p, Rock-walk, giving a general view of the rockwork garden.
- q q, &c., Beds of prepared earth, raised above the surface, and supported by large blocks of stone, forming an irregular rocky margin to each bed.
- r, A well, or basin, supplied by a spring, and furnishing abundance of water for watering the plants.
- r s, Direction of an excavation of 8 or 10 feet, forming an irregular precipice on the side next the house, with a bottom sloping in the opposite direction, from which all the rock was obtained for paving the rocky walk, and enclosing the raised beds. In the views from the windows of the house, none of this rockwork appears; the ground at t t t being sufficiently high to carry the eye over it to u. The plants in the rocky beds are partly half-hardy; such as fuchsias, myrtles, and other shrubs generally planted against conservative walls; a fine collection of azaleas and rhododendrons, particularly on the rocky precipices; *Berberis*, *Mahonia*, *Garrya*, and, in short, all the finer shrubs that are rather tender, and some of the more rare trees. There are also some fine specimens of perfectly hardy shrubs; such as of *Cotoneaster Uva-ursi* and *Juniperus Sabina repens*: the latter covers an entire bed.\* Among the more rare trees was one of *Pinus sinensis*, raised by Mr. Wells from seeds imported from China in 1829, and which had attained the height of 16 ft., and produced cones, before it was killed by the severe winter of 1837-8. (See *Arb. Brit.*, p. 2264.) *Araucaria imbricata* is here quite hardy; and *Picea Webbiana* has attained a considerable size, though much injured by the same winter. There are also remarkably fine specimens of *Abies Douglasi*, and of various other species of pines and firs. There are some remarkably fine young cedars, which, in 1837, when measured for the *Arboretum Britannicum*, were from 36 ft. to 52 ft. in height. One of these, which had been raised from seed exactly twenty years before, the cone having been purchased in a London seed-shop in 1816, was, in 1836, 36 ft. high, and the girth of the trunk, at 3 ft. from the ground, was 4 ft. 6 in. Another, 27 years planted, is 52 ft. high, with a trunk of 5 ft. 6 in. in circumference at 3 ft. from the ground. (See *Arb. Brit.*, vol. iv. p. 2406.) Among the herbaceous plants are most of the Californian annuals and heartseases, and all the finer half-hardy plants, such as petunias, lobelias, &c., and a great variety of pelargoniums. In short, if the reader imagine all the plants introduced into this country that it is desirable to cultivate in a flower-garden, or against a conservative wall, and in a select shrubbery, he will form a good general idea of what are planted on the rocky lawn at Redleaf.
- v, Engine-house, fixed over a pond, for throwing up water to the house.
- w w, Wood, in which many species of exotic trees and shrubs are introduced among the native kinds.
- x x, Wire fence, which separates the mown lawn from the pasture lawn.
- y, Pasture lawn; the surface of which is beautifully undulated, and finely varied by groups of oaks, thorns, and other trees. The thorns are, in some instances, of great age, and are often covered with a profusion of mistletoe, which in the winter season gives them the appearance of evergreen trees, and in spring interferes with that general covering of blossom, which, from its uniformity and whiteness, sometimes gives a large hawthorn the appearance of an immense cauliflower, or gives a spotty appearance to the landscape. We may observe, here, that there are various scarlet thorns distributed through these grounds; that two of them, in front of the Penshurst Lodge, are of an intensely dark red; and that others, which are seedlings of these, present different shades of colour, some being only a pale pink.

---

\* When Douglas, the botanical collector, visited Redleaf, and saw this juniper, he uttered an exclamation of delight, and threw himself down upon it, observing that he had slept many a night on such a bed.

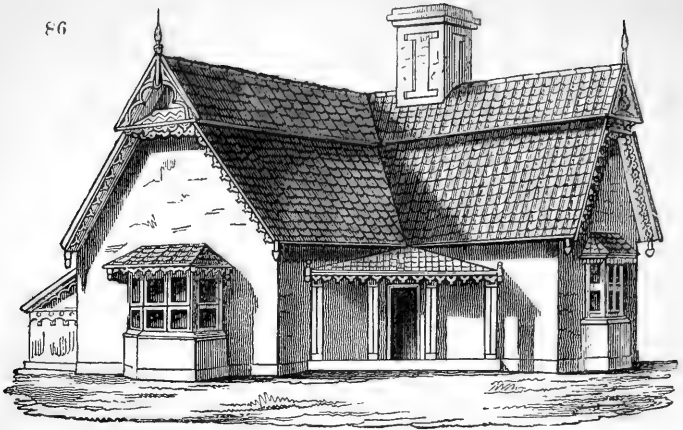


85



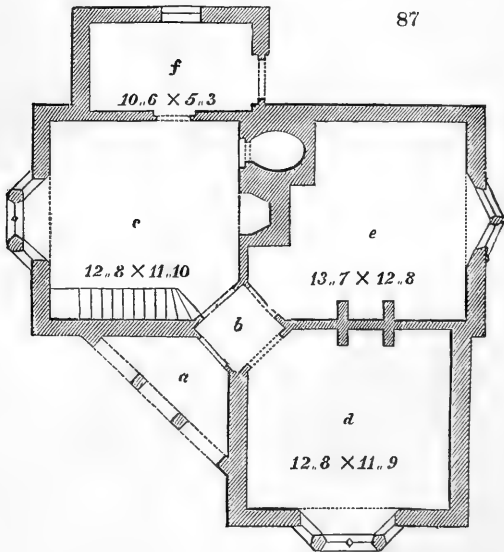
Entrance to the Rocky Lawn from the English Flower-Garden. The tree on the left is a cedar, upwards of 30 ft. high. The rocky precipice is slightly indicated in the middle distance, and the rocky walk in the foreground.

86



Elevation of Penshurst Lodge.

*Fig. 86.* is the elevation of the Penshurst Lodge, a perspective view of which is shown in *fig. 80*, in p. 364; and *fig. 87*, is the ground plan. This cottage is the dwelling of Mr. Wells's head gardener, Mr. Joseph Wells, who was born on the

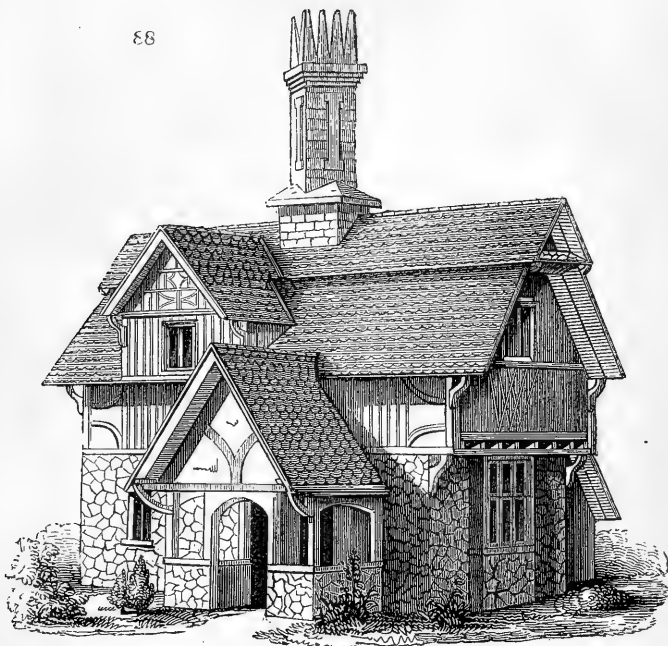


87

grounds, and succeeded his father as gardener. The plan exhibits an entrance porch, *a*; lobby, *b*; kitchen, *c*; parlour, *d*; family bedroom, *e*; and dairy, *f*. From the kitchen a stair-

case leads to three sleeping-rooms in the roof, and down to a cellar, pantry, &c., under the parlour and family bedroom floor. A shed for fuel, which in this part of Kent is chiefly wood, a drying-ground, small kitchen-garden, and other requisite conveniences, are placed adjoining, and appropriately arranged.

88

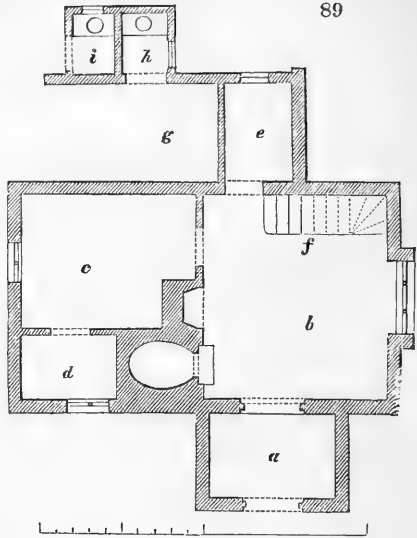


*Elevation of a Cyclopean Cottage designed for the Residence of an under Gardener.*

*Fig. 88.* is the elevation of a Cyclopean cottage, designed by Mr. Wells, and erected under his direction, as a residence for an under gardener. The term Cyclopean, as here used, applies only to the lower part of the walls of the cottage, which are formed of large irregular blocks of sandstone, without the slightest indication of horizontal or vertical courses. The effect, as contrasted with the numerous straight perpendicular lines formed by the studwork in the upper part of the walls, and with the horizontal lines of the tiling of the roof, is exceedingly good. The studwork is filled in with brickwork plastered over; the smoothness and finished appearance of which, as contrasted with the rudeness of the Cyclopean part, produces a forcible, and at the same time pleasing, effect. A great beauty in this cottage results from the horizontal division of the main body of the roof; the upper part of which projects

slightly over the lower part. The chimney top is massive, and original in design.

The plan (fig. 89.) contains a porch, *a*; kitchen, *b*; parlour, *c*; light closet, *d*; pantry, *e*; a staircase, *f*, to two good bedrooms above, and to a cellar under the parlour below; also an open shed, *g*, for fuel. A privy for women and children is shown at *h*, and one for men at *i*; the former being conveniently and privately entered from the wood-shed. The oven in the kitchen is shown large, to suit the description of fuel in general use by cottagers in Kent, viz. faggot-wood. We have shown, in Vol. VI. p. 143., how this fuel may be grown by every cottager for himself; and also how, by placing the oven in a cellar under the sitting-room, the waste heat might traverse under the kitchen floor in brick flues, and thus warm the whole house.



The roof is covered with plain tiles; but, if this building were imitated in America, or in any country where wood is substituted for tiles, it would be found, from the high pitch of the roof, particularly well adapted for shingles. Where stone was not plentiful, the lower part of the walls might be of brick or mud, on a foundation of brickwork or masonry; or of common brickwork or stone covered with cement, and blocked out into Cyclopean forms.

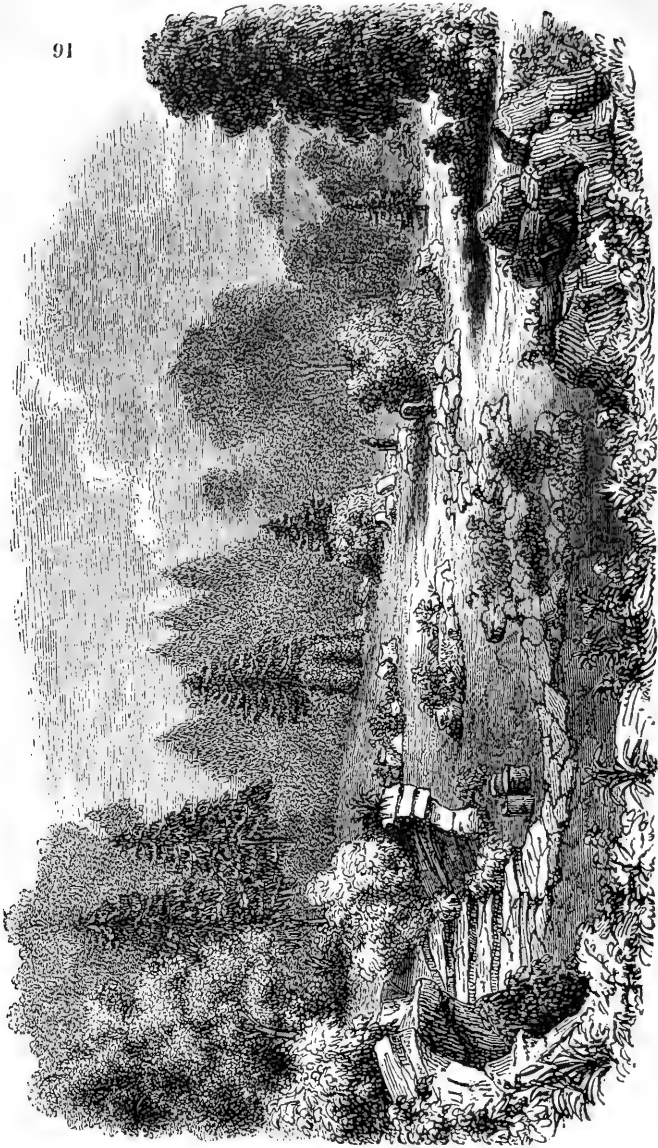
These two cottages were not only designed by Mr. Wells, but executed under his direction from his own working-drawings, and wholly from materials found on the estate; excellent sandstone rock, clay for bricks, and oak timber, being abundant, and chalk for burning into lime near at-hand.

In the house at Redleaf there is an excellent collection of pictures, chiefly by living artists, and including some of the best productions of Wilkie and the Landseers; Mr. Wells being one of the greatest encouragers of living native talent.

*Remarks.* The most original feature at Redleaf, as we have already observed, is the rocky lawn; and respecting it there are several points which require to be noticed. In the first place, a slight scar, or protruding rock, which appeared above the surface

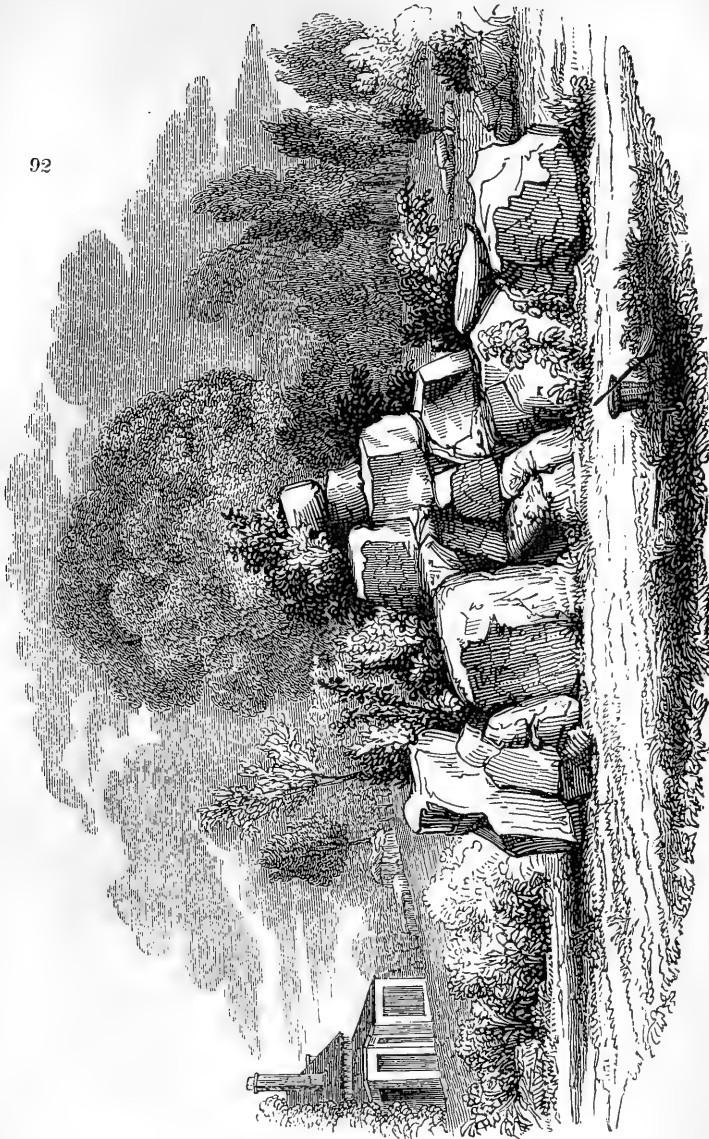


before any of the improvements were commenced, indicated that the same rock was abundant beneath the surface; secondly, the general slope of the grounds admitted of making a large excavation at this scar, and yet preserving the surface perfectly dry; thirdly, this excavation enabled Mr. Wells to get an extensive flower-garden near the house, which, at the same time, should not be seen from it; and, fourthly, this lawn was in harmony with the



*View across the Rocky Lawn, showing the Descent of the Rock Walk to the Rocky Hollow.*

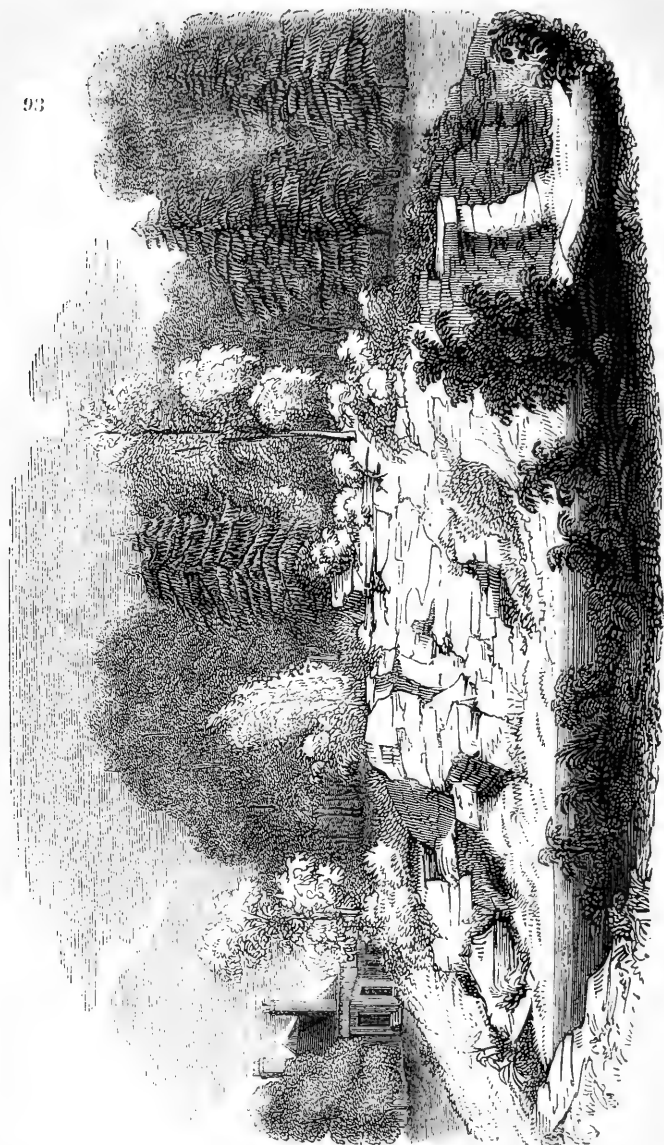
rocky bank in the English garden, and with the ledge or causeway in the rocky valley ; which ledge may be said to form, as it were, the key-note to the place. The suitability of the stone walk to this rocky garden is worthy of notice : not only does the material harmonise with the margins of the beds, and the rocky bank,



View of Part of the Rockwork on the Lawn.

better than gravel would have done, but, being on a steep slope, it is not liable to be washed away, as that material would have been, by every shower of rain. The walk is formed by flat laminæ of the sandstone, from six inches to a foot in thickness, not very even on the surface, and joined together in the most irregular

93



*View of the Rocky Precipice forming the North-East Boundary of the Rocky Hollow.*

forms, like the lava pavements in Portici, and other towns in Italy. The stones rise from 3 in. to 9 in. above the surface of the grass; the width averages from 4 ft. to 5 ft.; but sometimes, where very large stones occur, the walk is double that height. Sometimes we are inclined to think that, if this rocky walk only rose an inch or two above the surface, instead of 6 or 8 inches, the effect would



be better, and the walk would have the appearance of being more solid and secure, and it would, perhaps, also be less conspicuous at a distance; but we throw out the hint, as we do every other where Mr. Wells's taste is concerned, with great doubts. One valuable practice which is adopted at Redleaf is, that, in every part of the garden scenery where the slope is considerable, the walks are paved with brick, and have brick or stone edgings. Some great advantages result from this practice. The walks are never injured by rain, but rather improved by being washed clean; and, as no weeds can grow in them, nor can they get soft with rain, nor powdery with dry weather, they never require rolling. Gravel walks must be turned or partially renewed every two or three years; and the box, which is annually clipped, should also be taken up and replanted, sometimes every six or seven years. Brick or flagstone walks, or walks of asphalt, however, with brick or stone edgings, if properly laid at first on a solid foundation, and with such drainage as will admit of no water stagnating beneath the bricks, will last ten or twelve years, without any repairs whatever.

---

ART. II. *The Ancient History of the Rose.* By RANDLE WILBRAHAM FALCONER, Fellow of the Botanical Society, Edinburgh, &c.

(Read before the Botanical Society, Jan. 11. 1838.)

To the horticulturist the early history of the Rose may form a pleasing subject of study, while, perhaps, the scientific botanist will not find in it anything worthy of his attention.

In the following pages no attempt has been made to identify the kinds of roses mentioned by ancient writers, except in one or two instances, as the descriptions given of them are much too vague and indefinite to allow of any just conclusions being formed in regard to their respective species. The chief objects have been to enumerate and give the description of the roses mentioned by ancient writers, to show the periods of their flowering, their localities, the modes by which they were propagated, and the various uses to which they were applied.

Among both the Greeks and Romans some attention appears to have been paid to the cultivation of flowers, as offerings or as ornaments; as offerings in the temples of their deities, and as ornaments on occasions of public or private festivity. The Romans, however, appear to have esteemed flowers more than the Grecians, and the origin of this greater regard for them; may not improbably be found in the imitation of that luxury and splendour which the Romans had witnessed in eastern countries.

The rose is mentioned by Homer and by Anacreon. By

the former, in the hymn to Ceres; by the latter, in many of his odes; through which we learn that it was a flower remarkable for the beauty of its petals; that it grew amidst thorns; that it had a divine fragrance; was of the colour of the human complexion; that it was the most beautiful of all flowers; “the queen of flowers;” the “flower of love.”

Theophrastus and Pliny state that roses may be distinguished one from another by the roughness, smoothness, colour, smell, and the greater or smaller number of their flower leaves or petals. The latter writer, speaking of the rose generally, thus describes it: — “The rose grows upon a thorny, rather than on an herbaceous, plant; it grows also upon a plant similar to a bramble. There it has an agreeable smell, but not perceptible at any great distance. The whole flower sprouts at first enclosed in a calyx full of seeds, which in a short time swells, and becomes pointed at the summit like green alabastri.\* By degrees the flower grows, opens, and expands itself, containing in the middle of its calyx the erect yellow stamina.” This author then proceeds to enumerate eleven kinds of roses, which, he says, were well known to the Romans. They are the following: —

- |                     |                    |
|---------------------|--------------------|
| 1. Rosa Prænestina. | 7. R. centifolia.  |
| 2. R. Campana.      | 8. R. Græca.       |
| 3. R. Milesia.      | 9. R. Græcula.     |
| 4. R. Trachinia.    | 10. R. moscheuton. |
| 5. R. Alabandica.   | 11. R. coroneola.  |
| 6. R. spineola.     |                    |

Four other kinds of roses are mentioned by Pliny, in different parts of his *Natural History*; but of these he gives no description; they do not appear to have been in such high repute as the above, though somewhat esteemed for their medicinal properties. These kinds are called R. alba, pallida, spinosa, and quinquefolia.

Of the first two kinds of the eleven more particularly described by Pliny, the Campanian was the earliest in flower, and the Prænestine the first which ceased blowing. The Milesian was of a very bright colour, and consisted of not more than twelve petals: it was the latest which came into blossom. The Trachinian rose was less red than the Milesian. The colour of the petals of the Alabandic rose inclined to white: it was less esteemed than any of the preceding. The Rosa spineola had a large number of very small petals, and was the least esteemed of all. The Rosa centifolia, or hundred-leaved rose, had many small petals. It grew in Campania in Italy, and in Greece near Philippi; to the latter place, however, Pliny says it was not indigenous. It grew also in the vicinity of Mons

\* The “alabastrus” was a perfume-box which the rosebud resembled in form.

Pangæus; and the neighbouring inhabitants, taking it from this place, cultivated it for profit. The rose called Græca by the Romans, but by the Greeks Lychnis, had only five petals; it was of the size of a violet, and grew only in moist situations: it was scentless. The petals of the Rosa Græcula, which were very broad, were rolled or convoluted into a ball; they did not expand, except when forced by the hand, and had the appearance of always growing. The Rosa moscheuton had petals shaped like an olive, and grew upon a stem like that of the mallow. (“Funditur è caule malvaceo.”) The Rosa coroneola was an autumnal rose, and, when compared with other kinds of roses, had a flower of a middle size. All of the above-mentioned roses, according to Pliny, were destitute of fragrance, with the exception of the R. coroneola. The Prænestine and Campanian roses obtained their names from their respective localities. The Trachinian rose appears to have been a native of Thessaly, and grew near the city of Heraclea, called also Trachinia. The Milesian and Alabandic roses were probably foreign kinds; the former deriving its appellation from Miletus, a city in the Island of Crete, where it was first found; the latter from Alabanda, a city of Caria, in Asia Minor.

Mentzelius, in his *Lexicon Plantarum*, regards the Prænestine, Trachinian, and Milesian as varieties of what he calls the Rosa rubra saccharina; which he considers the same as the R. Græcula of Pliny. Mentzelius and Clusius both agree in calling the Milesian rose, the Rose de Provence. Ferrarius, in his work entitled *Flora, seu de Florum Cultura*, states that the rose called by him “Rosa alba multiplex” has, by different authors, been regarded as either the Rosa spineola, Campana, or Alabandica of Pliny. He says, also, that some authors consider the Rosa damascena multiplex to be same as the Rosa coroneola, while others, again, think it is the Rosa spineola, mentioned by Pliny.

The flower enumerated among the roses by Pliny, and which was called by the Romans R. Græca, but by the Greeks Λυχνίς (Lychnis), is the flower mentioned by Dioscorides under the name Λυχνίς στεφανωματική, or Lychnis coronaria. It is generally considered to have been a species of our present genus *Lýchnis*, commonly known as the rose campion. Dioscorides says, the “Λυχνίς στεφανωματική is a flower resembling the white violet, but of a purple colour.” It was woven into crowns, hence called στεφανωματική, or coronaria.

There is one other rose mentioned by Pliny, but not classed by him with the kinds most celebrated among the Romans, namely the Rosa sylvestris. This rose, called also Cynorhodon, by Pliny, and by Scribonius Largus R. canina, grew upon a briar, according to the former author, and had a leaf resembling

the impress of a man's foot. Theophrastus, who also mentions this rose, says it bore fruit of a red colour. Dioscorides agrees with this account, and says the fruit resembles the nucleus of an olive. Pliny, however, states that this plant bears a black berry; which, Bodæus a Stapel remarks, no other author has mentioned, and considers that the passage in Pliny refers to another plant, subsequently mentioned by that author. Among the thorns of the stem of the *Rosa sylvestris* grew a round sponge-like substance, resembling a chestnut; the presence of this excrescence upon this kind of rose is also mentioned by Marcellus, an old writer on materia medica. Pliny says it grew *particularly* upon the cynorhodon, and that it contained a worm or grub which produced the insects called cantharides. The same insects are mentioned by Aristotle to issue from a worm found upon the *κυνακάνθη*, or "dog-briar" (?). In the spongy substance alluded to, we recognise the moss-like prickly excrescences which are found upon all rose trees, but especially upon the *Rosa canina*, and which are the habitations of the insect called *Cynips rosæ*.

Commentators on Pliny regard the *R. sylvestris* of this author to be the *R. Eglantéria* of Linnæus, now the *R. rubiginosa*, which, according to Fries, Linnæus for a long time referred to the species *R. canina*. The cynorhodon of Theophrastus, the cynosbaton and oxyacantha of Dioscorides, the cynacantha of Aristotle, and the *R. sylvestris*, cynorhodon, cynosbaton, cynapanxim, and neurospaston of Pliny have been generally considered as identical. There still appear, however, to have been some doubts upon this point, which are not yet satisfactorily explained. It would be uselessly occupying space, to enter at length upon the consideration of this question. The *R. sylvestris* appears to have obtained its synonyme, *R. canina* or cynorhodon, from a supposition that its root was a beneficial remedy for bites of mad dogs; an instance of its curative powers is cited by Pliny.

The roses mentioned by Theophrastus are few in number, when compared with the list given by Pliny: four only are enumerated, viz.—

- |                      |                      |
|----------------------|----------------------|
| 1. Ῥόδον πεντάφυλλα. | 3. Ῥ. εἰκοσάφυλλα.   |
| 2. Ῥ. δωδεκάφυλλα.   | 4. Ῥ. ἑκατοντάφυλλα. |

The first of these is considered by Stackhouse to have been the same as the *Rosa canina* of Linnæus\*; the second has not been referred to any species with which we are at present acquainted; the third is thought to resemble the *R. cinnamomea*; and of the fourth, or hundred-leaved rose, Theophrastus says, "The inner petals are exceedingly small; for the blossom-

\* Illustrationes Theophrasti, &c. Auctore J. Stackhouse. Oxon. 1711.

ing is such, that some are inward and some outward. The greater number of such," he adds, "are about Philippi."

Theophrastus gives no detailed account of the roses he has named; he merely says that they are not large, and have *not a pleasant smell*. He enumerates the rose tree among perennial and woody shrubs; also among those plants which have their fruit placed under their flowers, "a peculiarity," he remarks, "which, on account of its great size, is most plainly to be seen in this plant." Some classical writers, who have endeavoured to show that the odes of Anacreon which eulogise the rose are frauds, have gone so far as to say that Theophrastus never saw a rose, and support this opinion from the very cursory manner in which he notices the plant. It is impossible, however, to coincide with them.

It is singular that Pliny has not mentioned the twice-blowing roses of Pæstum, so often referred to by Roman poets. Is the Prænestine or the Campanian rose to be regarded as the Pæstan rose, or a species of it? If so, is it not probable that Pliny would have noticed them more particularly? Of the Pæstan rose, we unfortunately possess no detailed accounts. They appear to have been extremely beautiful and fragrant, and to have grown very abundantly at the place from which they took their name. Virgil, Martial, Ovid, and Propertius constantly allude to the Pæstan roses, speaking at one time of their abundance, at another of their fragrance and colour.

But there is a rose which still blooms amid the ruins of Pæstum; and it is thus noticed by Mr. Swinburne, in his *Travels in the Two Sicilies*: "The Pæstan rose, from its peculiar fragrance, and the singularity of its blowing twice a year, is often mentioned with predilection by the classic poets. The wild rose, which now shoots up among the ruins, is of the small single damask kind, with a very high perfume. As a farmer assured me on the spot, it flowers both in spring and autumn." The Pæstan rose, according to most authorities, appears to have been of a deep red colour: yet Pomponius Fortunatus, in his notes upon Columella, says it was almost white; he further observes that it flowered in May and September.

Of the ancient Rosaria, or places set apart for the cultivation of rose trees, no account has reached us, as to the manner in which they were laid out. Pliny and Columella mention March and April to be the months during which the Rosaria should be dug up, and otherwise prepared for the reception of plants. Neither Columella nor Palladius mention by their names the kinds of roses which were cultivated in these plantations. This omission may, perhaps, be attributed to the kinds of roses used for wreaths, chaplets, &c., being generally known, since we learn that none but those so employed were planted in the Rosaria.

The most celebrated of these rose plantations were at Pæstum. It may here be mentioned, that the custom of rearing large plantations of rose trees still exists in the East, and in Russia, as appears from the following extract from Van Halen's account of his journey in that country. "On the following morning, we left our place of bivouack, in the vicinity of Kuba, with the rising sun, and proceeded through *picturesque fields covered with rose trees*. The exquisite fragrance emitted by them, and which the morning dew rendered more fresh and grateful; the varied warbling of a multitude of birds, who had their nests in these delightful bowers; and the sight of several cascades, whose playful waters leaped from their steep summits, produced on every sense an indescribable feeling of delight. One of the nobles belonging to the suite of Ashan Khan made me a present of a small flagon of oil extracted from these roses; and which, when some months after I compared with the best otto of roses of Turkey, surpassed it in fragrance and delicacy. Beyond these *woods of roses* spreads an extensive forest."

Roses, according to Theophrastus and Pliny, were raised, in some cases, from seeds; but they say that the growth of the plant when so propagated was slow, owing to the seed being situated within the bark under the flower, and having a woolly covering. Shoots or cuttings were also planted, and this mode of propagating the plant was preferred to the above, because their growth was more rapid.

The cuttings, according to Pliny, were four fingers or more in length, and were planted soon after the setting of the pleiades, perhaps, about April, and were afterwards transplanted during the following spring. The young plants were placed one foot distant one from another, and were frequently dug round. They required a light soil, not rich nor clayey, nor one in which there were springs. Their favourite soil was ground covered with the rubbish of old buildings.

The following account of the cultivation of rose trees is given by Didymus in the *Geoponics*.

If you wish, says the above writer, to have a constant succession of roses, plant and manure them every month. But roses are planted in various ways; some transplant them with the root entire; others take them up with the root, and cut them down to the size of four fingers in length, and plant all that is cut off the roots, and what grows from them, at the distance of one foot and a half from each other. Some weave wreaths of rose plants, and plant them for the sake of their fragrance. But we ought to recollect that roses will have more fragrance when they are grown in dry places, in the same manner as lilies have. Roses come early both in baskets and in pots, and require the same attention as gourds and cucumbers. If you wish those

rose trees already planted to bear flowers early, dig a trench two palms in breadth from the plant, and pour into it warm water twice a day. Democritus says that if a rose is (thus?) watered twice every day, in the middle of summer, it will bear flowers in the month of January. Florentinus says a rose may be grafted, or in-eyed, into the bark of an apple tree, and that roses will appear at the same time the apples do. If from a few plants you wish to make more, take cuttings of them, and, making them four fingers or a little more in length, set them into the ground. When they are a year old, transplant them at the distance of a foot from one another, and tend them by careful digging, and removing all the rubbish from about them.

It was customary among the ancients to cut back and burn down rose trees, by which means the trees were increased in size, and produced a larger number of flowers. Theophrastus says that the flower by these means was rendered more beautiful.

The rose, like the vine, appears to have grown most rapidly when transplanted; and Theophrastus informs us that, when this was done frequently, a more beautiful flower was produced. The rose tree cuttings required to be put into the ground deeper than young fruit trees, and not so deep as vines; the latter being sunk in the earth to the depth of two feet. Didymus observes that the fragrance of the rose is increased and improved by being grown in the vicinity of garlic.\*

The rarity of early roses made them valuable, and, like all vegetable productions obtained out of their season, they were eagerly sought after, and bore a high price.

“Rara juvant : primis sic major gratia pomis,  
Hibernæ pretium sic meruere rosæ.”

MARTIAL. lib. 4. epig. 29.

“The rare delights : we find first apples nice,  
And winter roses bear a tenfold price.”

ELPHINSTON'S *trans.*

The employment of warm water for forcing roses has already been mentioned. Palladius and Seneca both allude to this custom, and Pliny states that the time when it should be put into practice is when the calyx of the rose begins to sprout. Columella and Pliny state that it was usual to cover plants with the “*lapis specularis*” (talc), when it was an object to make them produce their fruits early; and this plan appears from Martial to have been pursued with respect to flowers also : —

\*

“The Pæstan rose unfolds  
Her bud more lovely near the fetid leek.”

PHILIPS, *Cider*, v. 254.

“ Condita sic puro numerantur lilia vitro,  
 Sic prohibet teneras gemma \* latere rosas.”

Lib. 4. epig. 22.

“ So through the crystal are the lilies told :  
 So does the gem the blushing rose unfold.”

ELPHINSTON'S *trans.*

Before quitting this portion of the subject, we must allude to a singular practice mentioned by Didymus in the passage from the *Geoponics* above quoted, namely the weaving of wreaths, and planting them; because Casaubon, in his *Comments upon Athenæus*, where a passage is quoted from Nicander's *Georgics*, in which it is mentioned, that frequently a complete crown made of ivy is planted, says, “Ridiculum est, . . . interdum coronam ipsam hederaceam cum suis racemis esse plantandam.” It is probable that Casaubon had not met with the passage in the *Geoponics* which proves the possibility of forming wreaths thus; and, moreover, shows that it was by no means an uncommon practice to “plant crowns.”

According to Nicander, in his *Georgics*, beautiful roses grew at a place called Themis, or Thetis; and at Olenum, a city of Achaia, not far from Patræ, now called Patras. Next to these places, Megara, Nisæa, Phaselis, and Tenedos were celebrated for their roses; but the finest grew at *Magnesia ad Mæandrum*, a city of Lydia, now called by the Turks *Gysel Hisar*, or the Beautiful Castle. One of the speakers in *Athenæus* is made to say that what is related by Æthlius Samius, in his work upon the singular occurrences which take place at Samos, namely, that in that island figs, grapes, apples, and roses are produced twice a year, appears neither improbable nor untrue. Cyrene, also, according to Pliny, was celebrated for its roses; and, according to Herodotus and Martial, Egypt was also renowned for these flowers. Herodotus says that in the gardens of Midas roses grew spontaneously, and that some had sixty flower leaves, and were more fragrant than the rest. †

According to the Calendar of Natural Occurrences in Greece, the rose blossomed in March, the *Rosa Græca*, or *Lýchnis coronària*, in May. In the Roman Calendar we find early roses were in blossom in April, and that in May they were generally in flower. In Egypt, according to Theophrastus, the rose blossomed two months before it appeared in Italy, and continued in flower for almost as long a time in the former country, after it had ceased blowing in Italy. In the latter country it succeeded the blossoming of the violet and the lily.

Among the ancients, the rose was employed as a medicinal

\* By “gemma” is to be understood the talc with which the roses were covered in gardens.

† See Miscellaneous Tracts, &c., on Natural History, by William Falconer, M.D., F.R.S.



remedy; at their festivals and sacred ceremonies; and as an article of luxury at their banquets. Of the medicinal uses of the rose frequent mention is made by Oribasius, Actuarius, Marcellus, Myriscus, Celsus, &c., together with many ancient writers on pharmacy; the accounts afforded by these writers are not sufficiently interesting to claim particular notice.

In alluding to the more general uses of the rose among the Greeks and Romans, the employment of flowers generally must, in some degree, be referred to; but the rose was unquestionably the most esteemed of all flowers.

By the Greeks and Romans flowers were frequently employed. It was usual for them to adorn the temples, altars, and statues of their gods with them. (See *Euripides: Hippolytus, Troades, Helena, &c.*) Wreaths of flowers were also worn by those who were present at, or assisted in, the celebration of sacred rites (*Eurip. Iphigenia in Aulide*). They were also offered to those divinities to whom they were considered most grateful. It was a Grecian custom, according to Athenæus, to decorate the doorposts of houses where a maiden, about to become a bride, resided. The dead were crowned with flowers.\* Sophocles has represented Electra and Orestes as repairing to their father's tomb, to deck it with garlands, and honour it with libations. The relatives of the deceased wore garlands of roses during the days of mourning, as emblematical of the shortness of life, which passes as quickly away as the beauty of those roses would which formed the mourner's crown. The tombs of the dead were decorated with roses, under the idea that they possessed the power of protecting the remains of the deceased, and were peculiarly acceptable as an offering to their manes. Other flowers besides the rose were selected as having a special fitness for these purposes. The Greeks also used the amaranthus, which is commonly regarded as the flower now known by the name of "everlasting." Parsley and myrtle were also funereal plants. But the rose has been for ages the favourite flower for funereal and all other purposes.

Among the Romans all flowers of a purple or white colour were regarded as grateful to the dead. They were so fond of the rose, that we find inscriptions which refer to legacies left in their wills, for the express purpose of providing roses, with which their tombs were annually to be decorated.

. . . . DONAVIT SUB HAC CONDITIOE

UT QUOTANNIS ROSAS AD MONUMENTUM EJUS DEFERANT.

(See *Le Antichità d'Aquileja*, Giandomenico Bertoli: Venezia, 1739: p. xix. ccxxxvii., &c.)

Roses were also strewed on the tables at their convivial en-

\* It is still a custom in the Levant to strew flowers on the bodies of the dead; and in the hands of young persons to place a nosegay.

tertains, and on the floors of the rooms in which they feasted. Pacatius says: "Delicati illi et fluentes parum se lautos putabant, nisi luxuria vertisset annum, nisi *hybernæ* poculis *rosæ* innatassent."\* Suetonius relates of Nero, that he spent upwards of thirty thousand pounds at one supper, in the purchase of roses. This custom is supposed to have been introduced during the time of Horace; an opinion which has been formed from one of his odes (lib. i. od. xxxviii.), thus translated by Francis:—

" I tell thee, boy, that I detest  
The grandeur of a Persian feast;  
Nor for me the linden's rind  
Shall the flowery chaplet bind:  
Then search not where the curious rose  
Beyond his season loitering grows."

Cleopatra is said to have expended a talent in the purchase of roses for one banquet, on which occasion the floor of the apartment was covered with roses to the depth of a cubit, or one foot and a half. (*Athenæus, Deipnosoph.* lib. iv. cap. ii.)

The chief use of the rose at feasts was to form crowns and garlands, which were placed upon the heads, and around the necks, of the guests. The garlands were generally provided by the master of the house. Those who attended on the guests were also crowned, and even the drinking-bowls were wreathed with flowers. Owing to this use of the rose, we learn from Anacreon that a crown composed of them was regarded as an invitation to festivity; they were also considered as preventives of drunkenness; though certainly, in some instances, the flowery wreath seems to have been a well understood mark of inebriation.

" Capiam mihi coronam in caput, assimilabo me esse ebrium."

PLAUTUS, *Amphitryon*, act. iii. sc. 4.

" I will place a chaplet on my head, and pretend to be drunk."

Rich unguents and oils were also prepared from the rose (see *Homer, Il.* xxiii. 186.), which were used on the same occasions as the rose flower itself.

There are many other less remarkable uses of the rose, which it would be necessary to mention, in order to render the above by any means a complete account of this flower; their importance, however, does not warrant their insertion here. To the philosophic botanist the above account of the rose will not, it is believed, be attractive; to the horticulturist it may present many pleasing features; to the classic reader, it will recall customs most intimately blended with the beauties of Grecian and Roman poetry. The feeling, too, which dictated some of the most striking and touching uses of the rose especially, and of flowers

\* "The soft and luxurious thought themselves not sufficiently refined, unless their extravagance changed the course of the seasons, unless winter roses floated in their cups."

in general, is universal and natural to nearly all nations. The decoration of the tombs of the dead with flowers was an inexpressibly beautiful custom; and, though strenuously denounced by the early Christians, as savouring of idolatry, the hearts of men soon wandered back to so simple, so elegant, so natural a mode of testifying affection. This is a custom which has been well said to be “of the heart, and to speak to it, and has therefore maintained its ground in every age and region, unaffected by the constant changes in customs merely arbitrary and conventional.”—*Edinburgh, April 29. 1839.*

---

ART. III. *Observations on the geographical Extension of the Cácti in Brazil.* By PROFESSOR VON MARTIUS.

(Translated from the “*Garten Zeitung*,” vol. i. p. 134., by J. L.)

THE family of the *Cácti* appears to have an extensive range in Brazil. Many species are found in the south, as far as the tropic of Capricorn, where I have been; and it frequently happens that a great number of the same species are found near each other. Towards the south, however, they begin by degrees to be more scarce, and at the river La Plata but few species can stand the night frosts. The climate also towards the west, under the same degree of latitude, in open extensive plains, where it is rather cold, appears but little favourable to the growth of the *Cácti*; and still further westward, in Chile, they are only found in considerable numbers on the warm rocky shores of the ocean. From La Plata northwards, the *Cácti* are found every where, and even throughout all Brazil, as far as the equator, and from there northwards as far as the boundary of the kingdom. They do not, however, appear in equal numbers all over this great extent of country; but those parts in which they are found the most numerous and characteristic are in the provinces of Pernambuco, Paraiba, Rio Grande do Norte, and Ciara; therefore the space between the 9th and 5th degrees of latitude may be considered as the most striking locality of the *Cácti* in Brazil.

The extension of the localities of the species appears to me more limited generally; because, probably, species, such as those of the genera *Cèreus* and *Opúntia*, which are considered as belonging to most of the tropical countries of the new world, are not distinct species, but only varieties nearly allied to each other. Particular attention ought, therefore, to be paid by travellers, when accompanied by an artist, if they wish to give a systematic and geographical description of these wonderful plants; because, on account of the difficulty of conveying them on a journey, and the similarity of their forms, the pencil of the artist can alone be had recourse to as the only certain means of displaying botanical

distinctions; and, although the cultivation from seed and cuttings succeeds very well in European gardens, the peculiarity of the species cannot with certainty be preserved. Whoever has seen the *Cácti* in their native country, and has observed the truly wonderful and grotesque character which they assume as a feature in the landscape, and has also observed their inclination to sport in our gardens, will not oppose the above statement. Such an enquiry into the difference of the species seems particularly necessary with regard to the genus *Opúntia*, because botanical writers know but little of them in their native country.

It is possible, certainly, that many species of this genus, such as *Opúntia spinosíssima*, *Tùna*, *polyántha*, *elàtior*; *Ficus índica* and *vulgàris*; and several species of *Cèreus*, such as *C. triangularis*, *trigònus*, *quadrangulàris*, and *pentagònus*, may have the most extensive localities: at least I have observed them under different latitudes in Brazil, and in different localities; and they were introduced into our gardens, before all the others, from the Antilles.

The *Cácti* require a dry, little variable, warm, and even hot climate, and a clear and almost unclouded sky. Such a climate as this is called in Brazil *mimoso*. These plants are therefore found in abundance in open plains, where there are no evergreen forests; but which are covered either with low bushes, leafless during the droughts of summer, or with small plants. We must not, therefore, look for the *Cácti* in forests which have a warm and damp climate; as their cool shade is as little favourable to the *Cácti*, so eager for the light, as it is for the *Agàve*, which is never found in such places, and is therefore erroneously so placed by artists in their views of tropical forests.

According to my observations, the *Cácti* are found on very different kinds of stone; and perhaps it is not so much the chemical formation of the soil, as the situation and temperature, which insures their successful growth. In Peru and Mexico they are frequently found on porphyry and many trap formations, and also on hard lava. In Brazil, I have seen them on granite, chalk, quartz, and mica slate, and more rarely on clay and chlorite slate, the latter of which appears to be less favourable to their vegetation than the others mentioned. They prefer a hard stony sandy soil or the crevices of rocks, to a light soil or rich loamy earth. Open, sunny, warm situations, on which even grass and other low plants can hardly grow, are often thickly covered with *Cèrei* and *Opúntiæ*, and *Mammillàriæ*; *Echinocácti* and *Melocácti* are frequently found, like our houseleek, on perfectly naked rocks. The *Peréskiæ* alone, which, from the nature of its leaves, announces that its respiration is more analogous to other plants, is found under trees and shrubs, and forms an excellent natural hedge, whereas the *Opúntia* requires to be planted when used for the same purpose.

The *Cácti* do not appear particularly affected by the different degrees of currents of air. It is well known that they are found near the sea, as well as on high mountains, where they grow abundantly wherever they have a sunny situation, and a clear and dry atmosphere; and where the glass is always a few degrees above the freezing point. They are found in Brazil, close to the sea, and on islands that have never been overflowed by it, above the line where vegetation ceases; and many species of *Cerei* are found on the dry hard sea shore. Most of the *Opúntiæ* are found more in the interior of the country, at a height of from 500 to 1500 and 2000 ft. above the level of the sea, and the *Melocácti* are also found high up the mountains. An attentive observer may perceive that in our gardens many species of *Cácti* require a variation of temperature, particularly during the winter months. Those who have such plants from Malpays, and the other warm districts of the *Tierra caliente* of Mexico, from the narrow hot valleys of New Granada and Peru, or the sea coast of Brazil, may observe that they frequently become sickly when they are exposed to a change of temperature of  $+ 6^{\circ}$  or  $8^{\circ}$  Reaum., while others, which are natives of high plains and of mountains, are much less susceptible.

Having made these general observations, allow me more particularly to add what I have had an opportunity of observing respecting the extension of the *Cácti* in Brazil. In the province of Rio Janeiro, which for the greater part is mountainous and covered with forests, I have only found species of the genera *Cereus* and *Opúntia* on the sea shore, and on dry high-lying places. They were tolerably numerous, so that they gave a very peculiar character to the landscape. The latter is used as a hedge for enclosures. The species, on the contrary, belonging to the division *Epiphýllum Herm.* (*Cerei alati De Cand.*) are very abundant in this tract of land, and ornament the trees of the forests, and the mossy rocks of the so called Organ Mountains (*Serra des Orgãos*), with their splendid-coloured flowers. Farther towards the south, in the province of San Paulo, the *Jamacarú* (*Cereus Jamarácu Dec.*) is very much cultivated in gardens, and also in dry fields. It forms a stem 30 ft. high, and is highly valued by the natives on account of its edible fruit. In this province, and in that of Minas, there are several species of the genus *Mammillària*, though they are but few in number compared with those above mentioned, because this genus appears to me properly to belong to Mexico. That part of the province of Minas which, in its vegetation, corresponds with the western territory of Espirito Santo and Porto Seguro, and which is partly shaded by thick and humid forests, and is the native place of the white topaz, the aquamarine, and the chrysoberyl, can produce but few specimens of the *Cácti*; but further to the

west, and more in the interior of the country, a great many *Opúntiæ* and *Cèrei* are found in bare sunny situations, and give quite a peculiar and romantic character to the landscape. The *Opúntiæ* are found more abundant in this district, on the mountains, and the *Cèrei* in the warm valleys. Other picturesque plants of the country, such as the tree lily (*Barbacènia* and *Vellòsia*), the tree fern, and shrubby kinds of grass, or the Brazilian fir (*Araucària brasiliàna*), are seldom found with the *Cácti*; so that, where the latter abound, they almost give the decided character to the landscape. In the rocky country of Comarca do Cerro Frio, the traveller is often struck with amazement at the numerous *Melocácti* which grow on the flat and naked rocks which abound with gold, quartz, and mica slate. There are many species of this genus, which are distinguished by the number of their ribs and spines; but as yet but very few of them are botanically known. They are called there, Monk's pate. This *Cáctus* is seen on the tops of high mountains in Minas Geraës, and in Peru and Mexico. I also observed it on the Itambé da Villa do Principe, and indeed even to its summit, where it grows with some species of *Xýris*, *Eriocaúlon*, several grasses, and the *Barbacènia excássa*, at a height of 5,590 ft. above the level of the sea. In the provinces of Bahia and Pernambuco, towards the north, the *Opúntiæ* are not so numerous as in Minas and San Paulo; but the prickly cereus is found in greater abundance, sometimes as a stately branched tree, from 30 to 40 ft. high, and sometimes spread out in the form of a many-branched candelabrum, or in thick espalier-like rows of trees growing very close together. They form here a part of the vegetation, which I have called the *Caatingas*, or sometimes the leafless forests. Some species of *Mammillària* are found here, particularly in the bare open plains; and the dry, bare, rocky districts, where the rivers are dried during the droughts of summer, seem to be the true localities of the *Cácti*. Where the mountains are from 3,000 to 4,000 feet in height, the same species are found on them as in Minas. In this part of the country the *Cácti* form an essential article of food for the numerous herds of cattle, to which may be added the fruit of the *ambú* (*Spóndias tuberòsa Arruda*) and the *joazebro* (*Zízyphus Joazeíro* Mart.). The cattle are very often attracted to the juicy stems of the torch thistles; and it not unfrequently happens, when they are tormented with thirst, that they attack the prickly branches to suck them, and get their mouths so wounded that mortification ensues. It is therefore quite an act of humanity, which the natives, while travelling, never fail to perform in these lonely districts, to cut off the young shoots of the *Cáctus* trees by the road sides, with their long forest knives, and in this manner to open a vegetable fountain

to the animals. The horses often try to obtain refreshment from the branches, by kicking off the spines with their hoofs. These spines are nearly a span long on some species (perhaps not yet well known to botanists), and they render the greatest prudence necessary when on horseback, and pursuing a narrow winding road. Where these species of *Cácti* grow in great numbers together, a part of the vegetation of shrubs and low trees generally disappears; such as that produced by the genera *Euphórbia*, *Tràgia*, *Cròton*, *Játropha*, *Túrnera*, *Echites*, *Big-nònia*, *Mýrtus*, *Terminàlia*, *Convólulus*, *Cæsalpínia*, *Erythróxy-lon*, *Sida*, *Tillándsia*, *Bromèlia*, *Pitcaírnia*, &c.; and the eye beholds nothing at a distance but the aspiring forms of the leafless *Cácti* against the dark blue stormy sky. The extensive deserts on both sides of the Rio de San Francisco, in the provinces of Bahia and Pernambuco, which, taken at an average, are from 500 to 1,500 feet above the level of the sea, consist of a bare granite, void of earth, or of limestone formation; and similar districts in the northern provinces of Paraíba, Rio Grande do Norte, and Ciara (those districts of Brazil in which the *Cácti* most abound), are remarkable for their great accumulation of sea salt, which oozes out of the ground after the rainy season. Here and there are found large caves of saltpetre, and remains of megalonyxes and mammoths, and in the chalk strata of Serra dos Cagrirês, there are petrified fish, which may be compared with those of Solenhofen. These geognostical appearances arise from the sea having formerly covered those parts, and, after its sudden retreat, the loose earth becoming separated from the stones, the lower animals inhabiting it were destroyed by the dryness of the ground, and the scorching heat of the sun. If such hypothesis could be proved, the *Cácti* (which, on account of their peculiar organisation, do not subsist so much from the nourishment of the soil, as from the state of the atmosphere), and other similar plants, such as liverwort, moss, &c., might be considered as precursors of a more exalted race on a more fruitful soil, like those leafless masses of gigantic plants which are found, the relics of the antediluvian world. The districts in which the *Cácti* are found at present in such abundance enjoy without exception the *clima mimoso*, already mentioned: and it has been observed that this climate is also favourable for producing the finest cotton on the cotton plants; while, in the northern provinces of Maranhão and Parà, though the plants are strong, the cotton is not of so fine a quality. These plants, also, are not cultivated where the *Cácti* grow, but in moist and shady places. The chain of mountains of Ibiapaba, consisting here and there of granite and strata of limestone, divides the land of the *Cácti* from the western province Piauby, a beautiful hilly country, gently sloping towards the north-east, and in

which the predominating stratum is sand and limestone. The *Cácti* are not so numerous here, and the extensive plains are ornamented with bushes, the joazeiro, and two kinds of palm (the *indaia*, *Attàlia cómpita M.*, and the wax palm, *Córypha cerífera Arr.*); yet sometimes groups of *Opúntia* may be seen, and enormous *Cèrei*, on hills exposed to the sun, the latter with stems frequently 18 in. in diameter at their base. Further north than Rio Parnahyba, the *Cácti* become more rare, and consequently, in the forests on the banks of the Amazon, they no longer form a picturesque and decided character in the landscape. I do not remember to have seen a stone, or a single plant of *Cèreus*, in the uninviting, dense, shady, and damp forests; but here and there a few species of *Peréskia* are seen in the hedges, and *Rhípsales* and *Epiphýlla*, and the large-leaved *Aróideæ*, *Bromèliæ*, and *Orchídeæ* on the stems of the old trees, filling up the narrow spaces between them. In the garden at Parà alone, I found, to my great astonishment, some *Cèrei* planted.

---

ART. IV. *Botanical, Floricultural, and Arboricultural Notices of the Kinds of Plants newly introduced into British Gardens and Plantations, or which have been originated in them; together with additional Information respecting Plants (whether old or new) already in Cultivation: the whole intended to serve as a perpetual Supplement to the "Encyclopædia of Plants," the "Hortus Britannicus," the "Hortus Lignosus," and the "Arboretum et Fruticetum Britannicum."*

*Curtis's Botanical Magazine*; in monthly numbers, each containing seven plates; 3s. 6d. coloured, 3s. plain. Edited by Sir William Jackson Hooker, LL.D., &c.

*Edwards's Botanical Register*; in monthly numbers, new series, each containing six plates; 3s. 6d. coloured, 3s. plain. Edited by Dr. Lindley, Professor of Botany in the London University.

*Paxton's Magazine of Botany, and Register of Flowering Plants*; in monthly numbers; large 8vo; 2s. 6d. each.

*The Floral Cabinet*; in monthly numbers, 4to; 2s. 6d. each. Conducted by G. B. Knowles, Esq., M.R.C.S., F.L.S., &c., and Frederick Westcott, Esq., Honorary Secretaries of the Birmingham Botanical and Horticultural Society.

*The Botanist*; in monthly numbers, each containing four plates, with two pages of letterpress; 8vo; large paper, 2s. 6d.; small paper, 1s. 6d. Conducted by B. Maund, Esq., F.L.S., assisted by the Rev. J. S. Henslow, M.A., F.L.S., &c., Professor of Botany in the University of Cambridge.

#### RANUNCULA'CEÆ.

1596. PÆO'NIA 28364 Brównii Bot. Reg., 1839, 30.

*Capparidæcæ* or *Sapindæcæ*.

*Diplopétlis Hugèlii Endl.* A beautiful plant, "with corymbose panicles of pink flowers, resembling those of a Cleome." It was raised by Mr. Toward



at Bagshot Park. Dr. Endlicher, who first described and named the plant, considers it to belong to Sapindacæ; but Dr. Lindley thinks it an anomalous form of Cappariacæ. (*B. M. R.*, No. 70., June.)

*Malvacæ.*

+ *Abutilon striatum* Dick. "A green-house shrub of the easiest culture and great beauty, being covered all the year long with a profusion of bell-shaped orange flowers, strongly veined with crimson, and dependent from long slender stalks." (*B. M. R.*, No. 53., May.)

*Balsaminæ.*

**BALSAMINA**

*Mastersiana* Paxt. Mr. Masters's  $\square$  or 1 my.o C Khosea 1837. S co Paxt. mag. of bot. [vi. p. 75.]

A very pretty annual species of balsam, found on the Khosea Hills by Mr. Gibson in 1837, which continued in flower during the whole summer of 1838 at Chatsworth. It is named in honour of Mr. Masters, of the Botanic Garden, Calcutta. (*Paxt. Mag. of Bot.*, May.)

*Rutacæ.*

1154. **CORRÆA**

*ferruginea* Hook. ferruginous  $\square$  or 3 ap.l G.W Australia 1836. C p.l Bot. no. 124.

Many new hybrid corræas have lately been introduced into our gardens; but this is a genuine species from Van Diemen's Land, where it was discovered by Major Dunn. It is a handsome shrub, with elegant foliage; and the flowers, though not brilliant in their colour (being of a greenish white), are large and well shaped. (*Botanist*, June.)

*Leguminosæ.*

1985. **LUPINUS**

*Hartwegii* Lindl. Mr. Hartweg's  $\circ$  or 3 jn.o Dk.B. Pk Mexico 1838. S co Bot. reg. [1839, 31.]

A very fine half-hardy Mexican annual, sent home by M. Hartweg. It has brilliant dark blue flowers, with a shade of pink, and obtuse very hairy leaves. It grows from 2 ft. to 3 ft. high, and flowers freely "from the end of June, until destroyed by frost in autumn." (*Bot. Reg.*, June.)

1940. **HOVEA** 30088 púngens Paxt. *Mag. of Bot.*, vi. p. 101.

1964. **CYTISUS** 17523 triflorus *Fl. Cab.*, No. 102.

+ *Isotropis striata* Benth. A very pretty little green-house shrub, with clear orange-yellow flowers, strongly marked with rich crimson veins. A native of the Swan River settlement, introduced by Robert Mangles, Esq. (*B. M. R.*, No. 61., June.)

+ *Gompholobium versicolor* Lindl. A climbing shrub, introduced by Mr. Mangles, with large flowers of a reddish-yellow, changing to a deep chocolate-red. (*B. M. R.*, No. 62., June.)

+ *Eysenhardtia amorphoides* Humb. Bonpl. and Kunth. A beautiful Mexican mountain shrub, or rather small tree, with small pinnated leaves, like those of an acacia, but distinctly marked with glandular dots. The flowers are small and white or pale yellow, and they are disposed in an erect compact spike, 2 in. or 3 in. long. (*B. M. R.*, No. 55., May.)

2144. **KENNEDYA** 19383 coccinea.

*Synonyme*: *Zichya coccinea* Benth.

+ *Chorozema varium* Benth. Another green-house shrub from the Swan River, introduced by Mr. Smart. Its leaves are greenish-grey, and its flowers orange and crimson. (*B. M. R.*, No. 62., June.)

+ *Acacia cyanophylla* Lindl. An acacia from the Swan River, also introduced by Mr. Smart, with long, glaucous, wavy leaves, "and a profusion of axillary racemes of yellow flowers." (*B. M. R.*, No. 64., June.)

*Philadelphææ.*

1479. **PHILADELPHUS** 30450 *Gordonianus* Bot. Reg. 1839, 32.

*Deutzia corymbosa* Wall. This very pretty Himalayan shrub, which was received under the name of *D. canescens*, has produced flowers for the first time in England, in March, 1839, in the Horticultural Society's Garden, in the

green-house. The flowers were "white, about half the size of those of *D. scabra*, lemon-scented, and arranged in copious cymes." (*B. M. R.*, No. 49., May).

*Loasacæ.*

2193. *LOASA* 30194 *lateritia*. *Synonyme*: *Caióphora lateritia Benth.*

The fact of the plant commonly called *Loasa lateritia* belonging to *M. Presl's* genus *Caióphora*, was first pointed out in *Mrs. Loudon's Ladies' Flower-Garden*, No. iv. p. 60.; but, as she observes, the plant is probably the *Caióphora punicea* of *Presl*, which is the *Blumenbáchia punicea* of *Mr. G. Don*, and the *Loasa punicea* of *Ruiz and Pavon*.

*Cactacæ.*

3359. *ECHINOCACTUS*

+*Scópa Hort. Berol.* Broom  $\square$  or  $\frac{1}{2}$  ap Y.s Brazil 1838. C s.p Bot. reg. 1839, 24.  
*Synonymes*: *Cactus Scópa Link*; *Cerèus Scópa Dec.*

A very beautiful and curious species of this curious genus, with pale yellow flowers, with a scarlet centre. "It derives its name of the Broom Cactus, from having the basis of its stem so long and stiff;" as somewhat to resemble a scrubbing-brush. It is a native of Brazil, whence it was first sent to Prussia. The specimen figured "flowered in the valuable collection of *Thomas Harris, Esq., of Kingsbury.*" (*Bot. Mag.*, May.)

*Compósitæ.*

3586. *LASTHENIA* 30141 *glabrata Lindl* *Synonyme*: *Hologýmne glabrata Bartl.*, Bot. mag. 3730.

1698. *GESNERIA* 30002 *elongata var. fruticosa Graham*, Bot. mag. 3725.

*Synonyme*: *oblongata Part. Mag. of Bot. vi. p. 103.*

The stem of this plant is about 5 ft. high, quite shrubby, and much branched. *Dr. Graham* received it in Sept. 1836, from the *Epsom Nursery*, under the name of *G. oblongata*; but it only differs from *G. elongata* "in its much shorter peduncles, in the more obtuse base of the leaves, in its less angular branches, and in the colouring of the veins and lower surface of the leaves generally." (*Bot. Mag.*, May.) In *Paxton's Magazine of Botany* for June, it is stated that *G. oblongata* is the true name.

*Begoniacæ.*

2654. *BEGONIA*

*sinuata Graham* sinuated  $\square$  pr 2 my.jn W ... 1836. C co Bot. mag. 3731.

A pretty kind of *Begonia*, sent from Berlin to the *Edinburgh Botanic Garden* and *Dr. Neill*, in 1836. (*Bot. Mag.*, June).

*Labiatæ.*

76. *SA'LVIA* *confertiflora Benth.*

A Brazilian species, with rather small orange red flowers. It was found near *Rio Janeiro* by *Mr. Macrae*; and, in the *Horticultural Society's Garden*, it has flowered in the green-house. (*Bot. Reg.*, May.)

*Amaranthacæ.*

\**TRICHINIUM R. Br.* (From *trichinos*, composed of hairs, in allusion to the shaggy flowers.) [1839, 28.  
+*alopecuróideum Lindl.* Foxtail-like  $\square$  cu 1 m.o P.B New Hol. 1836. S co Bot. reg.

This is the first plant that has flowered in Europe of the very remarkable genus to which it belongs, and only six species of which were described by *Dr. Brown*. The genus "is exclusively Australian." The present species was discovered by *Major Sir T. L. Mitchell*, and named by *Dr. Lindley* in a note to *Mitchell's Australian Expeditions*. At *Swan River* there are two other species, one of which *Dr. Lindley* has named *T. Manglèsii*, in honour of *Capt. Mangles*; and the other *T. Stirlingii*, in honour of *Sir James Stirling*. *Trichinium alopecuróides* "is a half-hardy annual, flowering abundantly in the open border during the summer, and although not appearing very pretty in a plate, it is sufficiently striking to deserve cultivation, for the surface of its flowers is glossy, like those of the cockscomb." (*Bot. Reg.*, May.)

*Urticæ.*

3420. *GALACTODE'NDRON* 28561 *ùtile H. B. & Kunth*, *Palo de vaca Span.*, Bot. Mag. 3723, 3724.

This very interesting tree is here figured for the first time in Europe. It was introduced, as appears by the *Hortus Britannicus*, in 1829, but has never

yet flowered in this country. Sir W. J. Hooker has given a general representation of the tree, which bears a close resemblance in height and shape to the celebrated Woburn Beech as figured in Pontey's *Forest Pruner* as a frontispiece; and he has given an engraving of the fruit included in the calyx, and the nut of which is about the size of a walnut; but a nut which we received from Messrs. Loddiges some years ago is a great deal larger. No flowers are given, and the foliage is "done from a living plant in the Glasgow Botanic Garden."

M. de Humboldt was the first to bring the Cow Tree of Caraccas into notice, in his *Relation Historique*, vol. ii. p. 106. "Neither the noble shadowy forests," says Humboldt, "nor the majestic current of rivers, nor the mountains, hoary with sempiternal snows, — none of these wonders of tropical regions so riveted my gaze as did this tree, growing on the sides of rocks, its thick roots scarcely penetrating the stony soil, and unmoistened during many months of the year by a drop of dew or rain. But dry and dead as the branches appear, if you pierce the trunk, a sweet and nutritive milk flows forth, which is in the greatest profusion at daybreak. At this time, the blacks and other natives of the neighbourhood hasten from all quarters, furnished with large jugs, to catch the milk, which thickens and turns yellow on the surface. Some drink it on the spot, others carry it home to their children; and you might fancy you saw the family of a cowherd gathering around him, and receiving from him the produce of his kine."

The representation of the entire tree was made from a drawing sent home by Sir Robert Ker Porter, in a letter dated Caraccas, June 8. 1837. The tree from which the drawing was made stands about 50 miles from Caraccas, on the steep forest-covered face of a mountain, estimated at 4000 ft. above the level of the sea.

"The forest was so densely thick and untravelled, that the people who accompanied us were obliged, at almost every step, to cut a way for us through it with their sword-like knives, while the excessive steepness and slippery state of the mountain rendered our advance both tedious and dangerous. However, after a couple of toiling days, we reached the group of sought-for trees, surrounded in all directions by others no less wonderful to look upon than themselves. The natives lost no time in making a deep incision into the bark of one, down to the very wood, from which burst forth the milk, white and limpid as that of the cow, sweet to the palate, and accompanied by an aromatic smell, but leaving a strong clamminess on the lips, and upon the tongue a slight bitter. In a quarter of an hour, we filled two bottles with the produce of a couple of trees; for, as our visit happened to be made during the wane of the moon, instead of at its increase, the lacteal fluid did not flow so freely as it is said to do when drawn during the latter-named stage.

"The trunk of the *Palo de Vaca*, from which the drawing was made, measured somewhat more than twenty feet in circumference at about five feet from the root. This colossal stem ran up to a height of sixty feet, perfectly uninterrupted by either leaf or branch; when its vast arms and minor branches, most luxuriantly clothed with foliage, spread on every side, fully twenty-five or thirty feet from the trunk, and rising to an additional elevation of forty feet, so that this stupendous tree was quite a hundred feet in all. I saw *others still larger*; but the state of the weather drove us from our position. The leaves, when in a fresh state, are of a deep dark and polished green, nearly resembling those of the laurel tribe, from ten to sixteen inches long, and two or three inches wide.

"With regard to the flower, or the flowering season of the tree, I have made enquiries over and over again, from persons who reside in the vicinity of other trees of the kind, in different parts of Venezuela, but they tell me that *no one ever saw or heard of the cow tree flowering.*

"The imaginary statement of the tree *not flowering* may be accounted for by the nature of the blossoms, being in all likelihood small and inconspicuous,

as in so many of the *Urticæ*, to which natural order it is probably correctly referred; though whether it be a true *Brosimum*, as Mr. Don is inclined to suppose, or a new genus, as Humboldt has suggested, must yet remain a doubt." (*Bot. Mag.*, May.)

*Orchidaceæ.*

2524. *CIRRHÆA* 29710 *fusco-lutea* *Bot. Mag.* t. 3726.

3582. *LÆLIA* + *furfuracea* *Lindl.* scurfy-stalked  $\text{£} \square$  or  $1\frac{1}{2}$  n Pk Mexico 1838. D p.r.w Bot. reg. [1839, 26.]

This species "was found near Oaxarca by Count Karwinski, and is probably not uncommon in collections, large quantities having been received by various persons from Mexico." It should be cultivated in a cooler house than usual for orchidaceous plants. (*Bot. Reg.*, May.)

30133. *autumnalis*, syn. *Blëtia autumnalis* *La Llave*, *Bot. reg.* 1839, 27.

This beautiful species flowered for the first time in England at Woburn. (*Bot. Reg.*, May.)

*L. majalis* *Lindl.*, syn. *Cattleya Grahami* *Lindl.* This plant, the *Flor de Mayo* of the Mexicans, was sent home in 1839, by M. Hartweg, "who found it on the mountains near Leon, growing upon oak trees, at the height of 8000 ft., where it sometimes freezes." From the dried specimens it appears to be a magnificent species; but "it proves exceedingly difficult of cultivation." (*B. M. R.*, No. 42., May.)

3734. *SCHOMBURGKIA* 37708 *marginata*, var. *pétalis sépalisque immarginatis* *Hook.*, *Bot. mag.* 3729.

Differing from the species in the margin of the petals not being yellow, and the lip more waved. It is a native of Surinam, and was flowered by Thomas Brocklehurst, Esq., of the Fence, near Manchester, in Dec. 1838. (*Bot. Mag.*, June.)

2540. *ONCIDIUM* 22693 *papilio* var. *limbatum* *Hook.*, *Bot. mag.* 3733.

*O. sanguineum* *Lindl.* "A noble species of this showy genus," with straw-coloured flowers, having crimson blotches. Imported by Messrs. Loddiges from La Guayra. (*B. M. R.*, No. 68., June.)

*Trigonidium tenue* *Lodd. Cat.*, No. 582. A native of Demerara, with brownish purple flowers. (*B. M. R.*, No. 59., June.)

3590. *LEPTOTES* 30163 *bicolor*, var. *glaucophylla* *Hook.*, *Bot. Mag.* 3734.

This plant was sent to Woburn (where it blossomed in Feb. 1839.), by Mr. Gardner, from the Organ Mountains; and it differs from the species in having very glaucous foliage and a white lip. (*Bot. Mag.*, June.)

2559. *ERIA* + *ferruginea* *Lindl.* rusty  $\text{£} \square$  or 2 mr Pk Calcutta 1837. D r.w.p Bot. reg. 1839, 35.

The foliage of a very dark green, and the smooth delicate pink petals, form a striking contrast with the coarse green shaggy sepals. The lip is most singularly crested, and looks more like the edge of some cowrie shell, than the petal of a flower. (*Bot. Reg.*, June.)

+ *Dendrobium Paxtoni* *Lindl.* A very handsome species of a well known genus, found at the foot of the Khosea Hills by Mr. Gibson, and named by Dr. Lindley in honour of Mr. Paxton. (*B. M. R.*, No. 56., June.)

*Dendrobium Heyneanum* *Lindl.* "This very pretty species has flowered imperfectly with Messrs. Loddiges, who received it from Bombay by the overland conveyance." (*B. M. R.*, No. 41. May.)

*D. macrophyllum* *Lindl.* This, the handsomest species of the genus, has been received by Messrs. Loddiges from Manilla. (*B. M. R.*, No. 46., May.)

+ *Otomèria tridentata* *Lindl.* "A Demerara plant of no beauty." (*B. M. R.*, No. 43. May.)

*Polystachya affinis* *Lindl.* "has lately flowered with Messrs. Loddiges, who imported it from Sierra Leone. It proves extremely different from *P. puberula*." (*B. M. R.*, No. 44., May.)

+ *Isochilus lividus* *Lindl.* "A small dingy-flowered plant, imported from Mexico by George Barker, Esq., of Birmingham." (*B. M. R.*, No. 45., May.)

*Cattleya superba* Lindl. Sert. Orchid. t. 22. A beautiful and very fragrant species, found in British Guiana by M. Schomburgk, who sent a living plant of it to Messrs. Loddiges. (*B. M. R.*, No. 47., May.)

*Epidendrum glutaceum* Lindl. A Brazilian plant, very near *E. fragrans*. (*B. M. R.*, No. 50., May.)

+ *Aganisia pulchella* Lindl. A very pretty new genus of Vandeous Orchidaceæ, sent by Mr. Brotherton from Demerara to Messrs. Loddiges. It is distinguished from *Maxillaria* by the brown sepals not being oblique at the base, and by the nature of the pollen masses; and from *Encnemis* differs in the form of the flowers, and in their regularity. (*B. M. R.*, No. 65., June.)

+ *Govenia lagenophora* Lindl. A "very distinct and curious species" of the genus; from comparing the description of which with Swartz's account of *Cymbidium utriculatum*, Dr. Lindley thinks that plant should be called *Govenia utriculata*. (*B. M. R.*, No. 66., June.)

+ *Brasavola glauca* Lindl. A most curious orchidaceous plant, procured by M. Hartweg near Vera Cruz; the habit of which is so much like "that of a *Cattleya*, that till it flowered it was expected to belong to that genus." (*B. M. R.*, t. 67., June.)

*Cymbidium bicolor* Lindl. This has flowered with Messrs. Loddiges, who imported it from Ceylon. A very handsome species, the flowers being "streaked or stained with very deep crimson." (*B. M. R.*, No. 69., June.)

2542. SACCOLOBIUM 31700 calceolare *Pact. Mag. of Bot.* vi. p. 97.

+ *S. micranthum* Lindl. This plant has flowered at Messrs. Loddiges, and should rather be referred to the genus *Cleisostoma*. (*B. M. R.*, No. 52., May.)

*Cyrtochilum stellatum* Lindl., Sert. Orch. pl. 7. This noble species has lately flowered in the nursery of Mr. Youell, nurseryman, of Great Yarmouth. (*B. M. R.*, No. 54., May.)

2542. CÆLOGYNE [rocks *Pact. mag of bot.* 6. p. 73.  
Gardneriana Wall. Mr. Gardner's £ [ ] or 1 d W.Y Khoseca Hills 1837. D trees and

The finest species of *Cælogyne* yet introduced. It was brought to England in 1837, by Mr. Gibson, the Duke of Devonshire's collector. It grows on trees and rocks in moist shady woods, or near a waterfall. Its flowers are white, with golden yellow bractæ. (*Pact. Mag. of Bot.*, May.)

ODONTOGLOSSUM *Humb. & Kunth.* (*Odous*, a tooth, *glossa*, a tongue; crest of the labellum.)  
cordatum Lindl. cordate £ [ ] el l ... B.P Mexico 1837. D p.r.w Fl. cab. no. 100.

For a description of this species, see *Gard. Mag.*, vol. xiv. p. 378., and *Second additional Supplement to Hort. Brit.* p. 701.

2477. SATYRIUM  
erectum Lindl. erect ¶ [ ] or 1½ f Y C. G. H. 1838. O pl Bot. no. 117.

This very showy species was imported from the Table Mountain, Cape of Good Hope, by Mr. Skirving of Liverpool, in 1838, and it flowered with him the following February. (*Bot. Mag.*)

*Pholidota articulata* Lindl. Also found by Mr. Gibson. The flowers are small, of a dirty white, with a little yellow; and the stem is jointed instead of being pseudo-bulbous. (*B. M. R.*, No. 57., June.)

*Phæus Wallichii* Lindl. in *Wall. Pl. As rar.* t. 158. "Another addition made to the Chatsworth collection, during his stay in India." (*B. M. R.*, No. 58., June.)

+ *Scaphyglottis stellata* Lodd. A native of Demerara, nearly resembling *S. violacea*. (*B. M. R.*, No. 60., June.)

*Iridaceæ.*

128. GLADIOLUS  
rambus *Pact.* branching ¶ [ ] or 5 jl Pk ?C. G. H. 1836. O s.pl *Mag. of bot.* 6. p. 99.

A very beautiful species of *Gladiolus*, growing 4 or 5 feet high, and producing several lateral spikes of large pink flowers. It was sent to this country

from Holland, but is a native of the Cape of Good Hope. It flowered in the nursery of Messrs. Lucombe & Pince at Exeter, in July, 1838. (*Mag. of Bot.*, June.)

*Amaryllidææ.*

3645. SCEPTRA-NTHUS 30681 Drummóndi  
*Synonyme* : *Coopèria pedunculáta Herb. in Bot. Mag. 3727.*

The Hon. and Rev. W. Herbert, having minutely inspected this plant, is "quite satisfied that it belongs to one genus with *Coopèria Drummóndi*, figured in the *Bot. Reg.*, t. 1835." (*Bot. Mag.*, May.)

*Liliáccææ.*

BESSERA Schultes fil. (In honour of *Dr. Besser*, Professor of Botany at Brody, &c.)  
*élegans Lindl. elegant* ♂  $\lambda$   $\square$  or 2 jn.o C Mexico 1839. D p.s Bot. reg. 1838, 34.

A very beautiful bulbous-rooted flower, found by Count Karwinski in Mexico. Another species of the genus flowered in England in 1832, and was figured in the *Botanical Register*, t. 1546., under the name of *Phàrium fistulòsum Herb.*; but the name of *Béssera* having been given to the genus by Schultes in 1829, it must take precedence. The flowers, which are pendulous, campanulate, and form a kind of head, are of a bright orange crimson, with red stamens and green anthers; the pollen, in a few days after expansion, becoming yellowish. (*Bot. Reg.*, June.)

*Melantháccææ.*

ASAGRE'A Lindl. (In compliment to *Dr. Asa Gray*, one of the authors of the *Flora of North America*.)  
*officinális Schlecht. officinal* ♂  $\lambda$   $\square$  cu 5 s.o W Mexico 1839. D Ls Bot. reg. 1839, 33.  
*Synonyme* : *Veràtrum officinále Schlecht*; *Helònias officinále D. Don.*

A half-hardy bulb, with a long spike of white flowers, growing 4 or 5 feet high; found by M. Hartweg near Vera Cruz, where it is called *Sabadilla*. Dr. Lindley considers that it does not belong to either *Veràtrum* or *Helònias*, on account of "the segments of the perianthium having a nectarifluous excavation at the base." (*Bot. Reg.*, June.)

*Aróideææ.*

2672. CALADIUM  
 +petiolátum Hook. petiolated ✱  $\square$  or 1 jn P Fernando Po 1832. T s.p Bot. mag. 3728.

A very singular plant, the tubers of which partly rise above the ground, and are marked with rings, apparently showing their "annual progress, and with scars, whence the old leaves and flower-stalks have fallen." When these tubers were first discovered in the island of Fernando Po, they were supposed to be a kind of potato, and they were unfortunately given to some cattle, which they poisoned. (*Bot. Mag.*, May.)

23484. *C. seguinum Ven.*  
*Synonyme* : *Dieffenbáchia seguinum Schott, Bot. No. 121.*

"The genus *Dieffenbachia* has been separated from *Caladium*, both on account of its being furnished with staminodia, and also from having the lower half of the spadix attached on one side to the spathe." (*Botanist*, June.)

ART. V. *Notice of Galphímia gláuca, and of a new Wistària.*

By D. BEATON.

LAST summer I saw a fine specimen of *Galphímia gláuca* of Cavanilles with Mr. Dodds, at Col. Baker's, M.P., Salisbury, from whom I received a small plant of it. It is now making its appearance in the London trade; and I wish to call the attention of amateurs to it, as a neat, free-flowering, and easily managed plant. When grown to a good specimen, it will be an excellent plant to exhibit in collections. I intended to send you a notice of it last season, on my return from Salisbury,

but the thing went altogether out of my head till the other day, when, in looking over a collection of dried Mexican plants by M. Hartweg, I found a nice specimen of it among the rest, marked No. 13.

The reason for the specific name *gláuca* is not sufficiently obvious: my foreman, an intelligent young man I had from Mr. M'Nab, tells me he had seen it last season in Edinburgh, under the name of *Malpíghia gláuca*. It is a malpighiaceous plant; and, if I had had the first naming of it, I certainly would have called it *Malpíghia spicàta*. It is an upright, much-branched, slender-growing shrub, with terminal spikes of small yellow flowers; the spikes are from 4 in. to 8 in. long, and, being produced on the top of every shoot however small, they have a light graceful appearance. The more the plant is pruned the more shoots it makes, and, consequently, the more it flowers. Two or three plants of it would keep a regular supply of blossoms in a collection all the season, if cut in at different times. It likes loamy soil, as do all woody plants that produce a long succession of flowers. It will flourish equally well in the stove and green-house; and, being from the same locality as most of our Mexican salvias, I have little doubt of its flowering well out of doors in the autumn. It is rather hard to strike; but a brisk bottom heat, bell-glass, and two months' patience and attention, are all that is necessary to propagate it. It will also produce seeds, though rather sparingly, and the flowers ought to be dusted with their own pollen, by way of encouraging it. It will be found a good trade plant, and well worthy of general cultivation.

The new species of *Glýcine*, or *Wistària*, from Moreton Bay, which I exhibited last year to the Horticultural Society, is now making an extraordinary sensation in the London trade. I have it in all sizes and shapes, and in all temperatures, from our hottest stove to the open air. I shall certainly have "bad luck," if I do not flower it first. I have had many enquiries respecting it; and this general notice must suffice for all. It is an exceedingly easy plant to manage, and not difficult to propagate; but, being in such extraordinary demand, it must be a dear plant for two or three years to come. Its foliage is much stronger than that of *Wistària sinénsis*, and consequently less liable to injuries; yet it is fully as handsome. I never rightly heard the exact colour of its flowers. It was sent home under a very flattering character by a good English botanist, Mr. Backhouse, brother to the celebrated nurseryman of that name at York. Mr. Low procured the stock of seedlings, which were only two plants: I got one of them, which soon developed its characters, and grew away freely. Being thus necessarily more acquainted with its habits than any British cultivator, it only remains for

me to say that no one need be afraid of losing it. It is of easy treatment, being not at all fastidious in its habits.

*Kingsbury Gardens, June 8. 1839.*

GREAT merit is due to Mr. Beaton for having brought this plant so early, and so prominently, before the public; having first exhibited it, as soon as he found it developing its characters from the seedling state. When he did this, the plant could hardly be said to exist in Europe. He deserves the greater praise for this liberality, since it too often happens, that the existence of rarities of great value, like this *Wistària*, is kept a secret by their possessor till the plant has flowered; or, what frequently happens, till it is lost to the country altogether. Had Mr. Beaton acted on this principle, this new *Wistària* might not have come into general cultivation for some years to come; whereas even now, we believe, it may be purchased in the Clapton Nursery. — *Cond.*

---

ART. VI. *A Selection of Heaths, made with a View of having several Species in Flower during every Month in the Year, with Remarks on their Culture, &c.* By W. A. MASTERS, late Sub-Curator of the Canterbury Museum.

OF all Flora's beauties, none, perhaps, lay claim to so much of our attention as the different species of heaths; for no one genus produces such a very numerous variety of exquisite forms, or presents such delicate tints of colouring, or such a diversified manner of growth; some of them being miniature representatives of the tallest pines of the forest, while others are so like the moss that surrounds them, as at a little distance easily to be mistaken for it.

It is only within the last few years that I have paid any attention to this truly lovely genus; and in that time I have proved that with a collection of 30 kinds, we may have several species in flower every day in the year, generally, I think, about six kinds, namely, during

*January and February.* *Erìca Linnæàna*, *Archèria*, *scabriús-cula*, *carinàta*, *grácilis*, and *pellúcida*.

*March and April.* *Erìca hírta*, *vestìta*, *árdens*, *hýbrida màjor*, and *cerinthòides supérba*.

*May and June.* *Erìca perspícua nàna*, *odòra ròsea*, *umbel-làta*, *versícolor*, *ventricòsa*, and *grandiflòra*.

*July and August.* *Erìca præ'gnans*, *Coventryàna*, *propéndens*, *verticillàta nòva*, *mammòsa*, and *Bowieàna*.

*September and October.* *Erìca Eweràna*, *acuminàta*, *mutábilis*, *concínna*, *vestìta*, and *vérnix coccínea*.



*November and December.* *Erica Archèria*, floribúnda, grácilis, cáffra, grandinósa, and *Persóluta*.

Having given the names of the kinds, and the order in which they flower, I shall now proceed to make a few remarks on their propagation, cultivation, &c.

For the purpose of increasing heaths, I have had an air-tight box constructed, like the one described by N. M. T. in the present volume, p. 21., which I find to answer the purpose exceedingly well. I think the best time for putting in cuttings is about December, in which case they will be struck and ready to be potted off in March or April; and, after being hardened by gradually inuring them to the air, they may be put into a frame out of doors. Much having been written on the subject of striking heaths, it would be useless for me to say much of it here; but I will make one observation, that is, the necessity of sorting the cuttings into different classes; for instance, the pine-leaved ones, like *E. vestita*, fúlgida, &c.; the hairy ones, such as *E. viréscens*, bícolor, hirsúta, &c.; and the quicker-growing ones, such as *E. Persóluta*, ignéscens, &c., should be kept separate; some of them striking in six or seven weeks, and others requiring three or four months, or even more.

After they have been hardened, they had better be removed to the cold-frame, or airy green-house shelf; I should recommend the former situation at all seasons, for heaths are not so tender as people are apt to imagine. As a proof of this, during the last two winters, they have stood uninjured with us, at St. Peter's Canterbury, in a rather unhealthy situation (it being both low and damp, and heaths succeeding best in a high situation and dry atmosphere), in a common pit of 4-inch brickwork. The bottom of this pit is a bed of coal-ashes, which the pots are placed on (not plunged), and on the top a single mat is thrown over the glass at night, and in case of very severe weather, two mats.

After the frost ceases, if the weather is gloomy, they may be entirely uncovered; if not, it is better to let the mat remain on a few days, giving the plant, at the same time, plenty of air. By this means I have never lost a plant, young or old, in the frame; while, in the green-house, plants are continually getting into an unhealthy state or dying; so that I have entirely left off keeping them in the green-house, except for show, while they are in flower.

One great reason for heaths disliking a green-house is, except when in a house by themselves, that the air is not so pure as when in a frame out of doors, it being charged with the exhalations of other plants. Again, in a green-house, the pots are generally placed on a stone bench, fully exposed to the scorching rays of the sun in summer, which dries them up and burns their delicate roots; and in winter, from the house being

obliged to be kept too close for them, they suffer from want of air, for, even during slight frost, heaths should be permitted to have plenty of air, as they like to feel the wind between every leaf.

Towards the latter end of the summer, heaths are often very much affected by a kind of fungus, which spreads itself over their stems and leaves, and finally kills them. This fungus increases with such amazing rapidity, that one diseased plant will affect a hundred in the course of one week, if not instantly removed. The best cure, and I believe the only cure, is to wet the leaves of the plants affected, and immediately afterwards powder sulphur vivum thickly over them, letting it remain on for a few days, after which it may be washed off, and the plant replaced in the frame.

*London, June 1. 1839.*

---

ART. VII. *A Pine-apple Conservatory.* By ALEXANDER FORSYTH.

I AM perfectly certain, that, if the culture of pines, planted out in a stratum of rich mould on a gentle bottom heat, were more generally understood, it could not fail to be generally practised. If you ask the opinions of practical men on that point, they will be almost unanimous in saying, "We have no doubt that pines planted out produce heavier and more perfect fruit than those cramped in pots; but, since we can have no control on their coming into fruit, when once they are established in luxurious liberty, we prefer growing them in pots." It will therefore be allowed, that if they could be controlled, so as to show fruit immediately after they have attained proper size, and got their roots well established in the border, the great desideratum would be gained, and prize-fruit growers would find this the surest system to surpass the pot-bound productions of their rival brethren. Now, having seen various systems adopted, in order to induce pine plants to show fruit, or, in other words, to arrive at maturity, I think they all may be reduced to two, either patiently and perseveringly aiding and encouraging the plants by kindness till they arrive at that maturity where nature seeks no further; or else, by unnatural strides of starvation and excitement, producing partial decay, and premature fructification at the proper cost, namely, a deficiency in the fruits, both in weight and flavour.

Having been placed lately under rather peculiar circumstances with a stock of pine plants, after milder means had failed to excite their *visible* qualities, I resolved to get them up (that is into fruit) at all hazards. They were in number about 30, and the greatest part of them not less than three years old, when I planted them out in a stratum of turfy loam and leaf soil, on a bed of leaves, at the hottest end of a fruiting

pine-pit. As soon as the roots began to run in the fresh soil, the leaves lengthened and strengthened very fast; and, finding them so much at home in their new situation, I resolved to make them accommodate themselves to the place they seemed so much to enjoy. As soon, therefore, as their leaves reached the glass, I took the tip off every one, even down to the innermost leaf in the centre of the plant, by means of small French pruning shears, the blunt crooked points of which peculiarly adapt them to this curious operation of tipping one leaf closely folded on another, without pricking the rest. The leaves, thus shorn of their extreme points, lengthened very little after; but those which were so young and small as to be out of sight in the socket at the time of shortening advanced in height rapidly; those also I tipped, as soon as they came within reach of the guillotine; and the result was, that I had not only the satisfaction to see an old and inveterately backward stock of pine plants show and swell off respectable fruits, but the stools allowed to remain, after taking off their lower leaves and earthing up the stem, soon produced suckers of a very superior size, and in great abundance.

*Alderley, Cheshire, August 6. 1838.*

---

ART. VIII. *Remarks on the Cultivation of the Vine.* By JAMES HUTCHINSON, Gardener at Cranston Hill, near Glasgow.

WHEN I came to this place, in November, 1834, I found the vines of one of the hot-houses trained irregularly under the roof of the house; when pruning them, I cut most of the young shoots down to five eyes, some to four, and such as were weakly to two or three eyes. I obtained a tolerably good crop of grapes by this system; but, unless particular attention is paid to summer pruning, vines cut by it soon assume a very confused appearance. However, I may observe that I consider this a very safe mode of pruning; for, if the young wood has been sufficiently ripened, there is every reason to expect a fair crop.

In the winter of 1835-36, I loosened all the vines in one of the hot-houses, and trained an old shoot underneath each rafter, and another under the centre of each light, with the intention of introducing the "spur system." In this winter's pruning, I cut a good many of the young shoots down to two and three eyes. The shoots of moderate growth that were cut in this manner bore a fair crop; but of all the strong-growing shoots that were cut to two or three eyes, not above one or two bore fruit. However, I don't mean to insinuate that I consider the "spur system" a bad one; for I am well aware that good crops of grapes have been produced by that method, in various

parts of the country. I merely assert that it failed, in a great measure, with me; so that were a young man to take the management of a vine-house, and adopt the "spur system" with all his vines indiscriminately, he might find, to his disappointment, that he had made a mistake. The "spur system" may be well adapted for weak vines, or for hot-houses that are forced early in the season; but should never be applied to vines of strong and vigorous growth, that are intended for late forcing.

For the last two years I have endeavoured to introduce the "long system" of pruning; and, as the vines are healthy and vigorous, I have now got my intentions effected in the greater part of the house which has been the chief subject of my experiments. My present mode of pruning and training is very simple. The vines are trained under the roof of the house, about 1 ft. from the glass; and the length from the foot of the trellis to the top of it is about 20 ft. This space would require one line, consisting of five young shoots, under each rafter, and another line of young shoots under the centre of each light. The distance between these lines is 1 ft. 9 in. These shoots should have from eight to ten or twelve eyes, according to their strength; and the upper end of each shoot, when pruned and tied in winter, will reach to the lower part of the one above it, or nearly so, with the exception of the uppermost. The young shoots which come from these, and which bear the crop the following season, are all, with the exception of the leaders, tied close in to the main line of shoots, and stopped at the first joint above the fruit. The leaders, I train about 6 in. distant from the main line. For example, the first leading shoot is trained to the right of the main line; the second to the left; and so on alternately, leaving a space of 9 in. between them and the leaders of the adjoining main line. There will be two leaders on each side of the main line during summer, besides the new leader at the foot of it. As the uppermost shoot of each main line will be cut off in the following winter's pruning, the leader arising from it may be trained along the top, and stopped at the first joint above the fruit. The leaders I allow to run from 5 ft. to 8 ft., in proportion to their strength. In the following winter's pruning, all the young shoots are cut away, with the exception of the leaders, or those at the foot of the trellis, intended to become leaders. The leaders belonging to each main line are cut down to eight, ten, or twelve eyes, and trained in one line, as before mentioned.

It will be evident to many gardeners, that, by this system, a shoot must be cut from the top, and another introduced at the foot of the trellis, at every winter's pruning; and care must be taken to have a reserve always at the foot of the trellis, by cutting down a young shoot to two or three eyes. Supposing that such a shoot emits two young shoots, one of them can be trained as a

leader, and the other cut down as formerly. But I frequently have shoots emitted from the old wood, and from the very roots of the vines, which furnish better succession than any that I cut down for that purpose.

As to the advantages of this system, I am quite convinced of its superiority over every other mode. The vines are easily managed in summer, and have at all times a neat and systematic appearance; and I may venture to say that there is no system of pruning by which so great a crop of grapes can be obtained.

However, it would be of no use to leave so much wood on weakly vines, as I have recommended. If vines are in a weak state, the border in which they grow should be renewed; as no system of pruning will cause such vines to bear a great crop. Many object to the "long system" of pruning, by saying that it is useless leaving eight or ten eyes on a bearing shoot, as only three, or, at most, four, will break. Such is not the result with me. Every eye uniformly breaks with me, with the exception of two, or perhaps three, at the foot of each shoot.

This leads me to say a few words relative to the temperature necessary for the vine. I commence forcing about the end of February, or beginning of March; previously to which, I cover the vine border, to the depth of 10 or 12 inches, with horse dung of the best quality. Before this dung is laid on the border, it should be thrown up in a heap for two or three days, until it begins to heat properly. It should then be laid on the border without delay, as its powers will be greatly weakened by the process of fermentation. The temperature of the surface of the border will be raised, by means of this dung, to about  $50^{\circ}$  Fahr.; a point of great importance. It is evidently contrary to nature to be forcing the vines, when the roots are exposed to cold, or, at least, deriving no warmth to stimulate the juices of the plants. I keep the temperature in the hot-house at about  $50^{\circ}$  in the morning, at first; and about  $55^{\circ}$  during the day, if dull weather. If the nights are very cold or frosty at the commencement of forcing, if the thermometer is  $48^{\circ}$  in the morning, I am satisfied. This heat is continued until the buds are all broken; after which the thermometer may be allowed to range between  $50^{\circ}$  and  $55^{\circ}$  in the morning, and about  $60^{\circ}$  during the day, if dull weather. In clear weather, from the commencement of forcing, I open the upper door of the furnace, merely keeping the fire in during the day; and allow the temperature to rise in the hot-house to  $70^{\circ}$ ,  $75^{\circ}$ , or even  $80^{\circ}$ . Were there a continuance of clear weather at this stage of forcing,  $80^{\circ}$  would be too high; but, for a day or two, it does not matter, although the thermometer should rise to  $80^{\circ}$  in the middle of the day. This temperature should be continued during the day, should the

weather be clear, until the first leaves of the vines are fully expanded; when the temperature may be kept between  $85^{\circ}$  and  $90^{\circ}$  in the day time, in clear weather. When the vines are in flower, I keep the temperature between  $55^{\circ}$  and  $60^{\circ}$  in the morning; and between  $65^{\circ}$  and  $70^{\circ}$  during the day, if dull weather, and about  $85^{\circ}$ , if sunshine. After the grapes are set, the thermometer may be allowed to rise to  $90^{\circ}$  or  $95^{\circ}$  during the day, in clear weather. In dull or wet weather, in summer, instead of kindling fires at night in the ordinary way, I cause the flues to be heated in the morning, in order to raise the mercury in the thermometer to about  $70^{\circ}$  during the day; and allow the fire to burn out towards night. The temperature, in the day time, from the commencement of forcing, should be regulated, in some measure, by the heat of the vine-house during the night. For example, if the house has been colder during the night than I could wish, I keep up a greater heat than usual during the following day; and, if it has been warmer during the night, than I consider requisite, I give less fire during the day than usual; or more air, according to the state of the weather. In order to have the young wood sufficiently ripened, if there is any appearance of frost at night, towards the end of autumn, I cause a small fire to be kindled just sufficient to keep the frost out of the house. This is continued, when the nights are frosty, until the leaves are all down. As regards exposure of the vines in winter, I had my vine houses shut all last winter, as I see no use in exposing the vines in winter.

Many may object to the lowness of the temperature that I have recommended during the night, when the grapes are in flower; but all the kinds cultivated here, including the Tokay, black Hamburg, white sweetwater, &c., uniformly set well with the heat above-mentioned. Indeed, when the nights have been frosty during the time my vines were in flower, I have seen the thermometer as low as  $52^{\circ}$  in the morning; and I never observed that they sustained the least injury by this low temperature. Too much dependence has hitherto been placed on the influence of fire heat in the forcing of hot-houses. The great art is to do with as little fire heat as possible; and to take the utmost advantage of the heat derivable from the sun's rays, consistent with giving a sufficient quantity of air. The legitimate use of fire heat is to prevent the bad effects of frosts, snows, and inclement weather.

I may now say a few words on giving air. In clear weather it should always be given early in the morning, and taken away early in the afternoon. For example, let a small portion of air be given between eight and nine o'clock in the morning, and if the day continue clear, give more between ten and eleven, and take it all away at three o'clock. I seldom let air into my vine-

houses after three o'clock in the afternoon. If air be admitted until the house is completely cooled, a large fire may be necessary to support the requisite temperature; and it is evident that sun heat is better and cheaper than fire heat. In cold dull weather, when there is no sunshine, unless the day should be stormy, a little air, although only for a quarter of an hour in the middle of the day, will be beneficial. This will be unnecessary in dull weather, before the buds of the vines are well swelled. From this stage, until the first leaves of the vines are fully expanded, plenty of air should be given during the day, in clear weather; but, as the plants become covered with foliage, less air will be requisite, until the grapes are nearly ripe; when air should be more copiously admitted, so that the fruit may be well flavoured. The details of watering, &c., are generally known to gardeners. Those who want grapes early in the season must, of course, commence earlier than I do; and, perhaps, give a little more heat during the day, in dull weather, than I have recommended; but the temperature I keep my vines at, during the night, is quite sufficient for a vinery. Vines in pine stoves must, of necessity, be subjected to different treatment; but in vine-houses where grapes are not required until the end of July, or beginning of August, the plan that I have recommended will be found an easy, economical, and successful mode of obtaining a good crop.

*Cranston Hill Gardens, Sept. 22. 1838.*

---

ART. IX. *Historical Notices respecting the Training and Pruning of the Peach Tree in France.* Extracted from a Report made to the Horticultural Society of Paris in July, 1836, and published in the "Annales d'Horticulture," vol. xix.

SINCE the age of Louis XIV., the commune of Montreuil has been celebrated for the culture and training of the peach; and its industrious and laborious inhabitants are almost all exclusively devoted to the same pursuit, and with equal success. The fame of Montreuil attracted the attention of the famous La Quintinie, the founder and director of the fruit and kitchen garden at Versailles. La Quintinie, who was then considered the first trainer of trees in Europe, was astonished to hear that these simple villagers were successful, by following principles different from his own. He therefore engaged the son of Pepin, one of the most distinguished persons employed in training the peach in Montreuil, to leave his native village and come to Versailles, and train the trees in the royal gardens under his immediate inspection. It is unnecessary to mention the disputes that arose between young Pepin and his master, and we need only say that they did not agree; that the young Pepin returned to train his father's trees

at Montreuil, and that the *taille à la Quintinie* has continued to be prevalent everywhere. No doubt, these words are used hyperbolically; but I will be forgiven this presumption, when it is recalled to mind that under Louis XIV. servilism and mimicry were carried to the greatest excess; that the nobles and courtiers liked their gardeners to train their trees *à la Quintinie*; that all sensible gardeners refused to do so, and preferred leaving their places, or to be turned away, rather than submit to the absurd system of *Quintinie*. It was a true revolt of good sense against an absolute folly.

However, justice was at length rendered to the Montreuil method, and that of the director of the fruit-garden of Louis XIV. was condemned, as alike contrary to nature and the interest of the cultivator. This equitable judgment, declared a century after the death of *Quintinie*, and confirmed by experience, can no longer be questioned. In short, the system of *Quintinie* was founded on this axiom, "defer enjoyment, in order to enjoy for a longer time;" an axiom very just in many things, but altogether false in the culture of fruit trees. *Quintinie* cut in very much, in order to keep the trees growing without producing fruit, and in the hopes of thereby making them live much longer; but it so happened, both to *Quintinie*, and to those who followed his principles, that trees which bore fruit naturally after being two or three years planted, did not do so when treated *à la Quintinie* till after ten years, and then only in a very small quantity, and sometimes not at all; while trees pruned according to the Montreuil method, at the age of ten years, paid a hundred times their cost, and a hundred times the rent of the land they occupied.

It is not a little remarkable, that the pruning of peach trees was brought almost to perfection at Montreuil about the time of Louis XIV., people do not know very well how, and that it has remained in the same state till within the last dozen years. During that short period, it has been brought to perfection, as M. Lelieur has demonstrated in his *Pomone Française*. The pruning of peach trees in France has been reduced to three schools, viz. :—

The school of *Quintinie*, of which the principle was to cut short, and to retard the production of fruit, and to lengthen the lives of the trees.

Second, The school of Montreuil, of which the principle is to cut long, and the end to obtain abundance of fruit. Rogers Schabol is the most ardent of the numerous panegyrists of this mode.

Third, The modern school, of which the principle is the same as that of the school of Montreuil, and the end to obtain trees full and regular in their branches, without these being confused



or crossing each other, and well furnished with fruit. M. le Comte Lelieur was the founder of this school in 1817, in collecting its scattered elements, which already existed in the practice of many cultivators, and in joining thereto the results of his own experience. The addition which Count Lelieur may be said to have made to the Montreuil method consists in filling up the two sides and the centre of the tree with branches. In the Montreuil method, as those of our readers who have looked into our *Encyclopædia* must be aware, there are two main branches allowed to every tree. These are, in general, trained in at an angle of  $45^{\circ}$ , and the side branches proceeding from them are laid in in such a manner as to cover great part of the wall. There is always, however, a space in the centre of the tree, and also one on each side of it next the ground, which is left naked. Now, the grand object of Lelieur's method, or that of the modern school, is to fill up these naked spaces with bearing wood. This is to be effected by shortening the two main branches when young, so as to produce four branches, and the side shoots of these being trained in with care, the wall will generally be found filled up. In doing this, when the lower branches of the tree are found weak, they are not trained in like the others, but allowed to grow right out for two or three months, during which time they acquire a degree of strength as great as that of the branches on the upper part of the tree. The methods of the three schools are evidently different modifications of what in England is called fan-training; and there can be no doubt whatever, that the modern method, its object being to cover the wall completely with wood, is by far the best.

The origin of training the peach and the vine against walls is thus given by Rogers Schabol. A cultivator of Montreuil having by chance thrown the stone of a peach against a wall with a south aspect, it grew up and produced fruit, which, from the shelter and heat of the wall, were found to be larger, more succulent, and of better flavour, than those produced on standard trees. This cultivator seeing that the heat of the wall was favourable to the peach, fastened the shoots to it with nails and ties, and found the fruit still larger and better. In what year this cultivator lived is not stated; but he is considered as much more likely to be the inventor than Girardot, to whom it is generally attributed. This Girardot lived in the time of Louis XIV., when training the peach had already been practised at Montreuil sufficiently long to produce young Pepin, who was the pupil of his father, already celebrated for training the peach.

ART. X. *On shading Melon and Cucumber Plants.* By JOHN WIGHTON, Gardener to Lord Stafford, at Cossey Hall, Norfolk.

It is a very common practice to shade melon and cucumber plants from bright sunshine; but I am convinced that more harm than good is the result of such a practice. Of late years, I have not shaded my plants; and, though the glass which I use is very clear, I never find the plants injured by the sun, when plenty of air is admitted. There are two cases in which the plants seem to require shading: first, when the plants are very weak, or newly planted; and, secondly, when there has not been enough air admitted to the plants during sunshine. In the first case, a little shading is required when the sun shines; but it must not be long continued, otherwise the plants will be weakened for want of light. In the second case, no shading is requisite, provided that plenty of air is admitted.

The evil of too much shading has arisen in a great measure from the false notion, that the leaves are burnt by the action of the sun through the glass; but the truth is, that this is occasioned by the hot air confined in the beds. When shading is once resorted to, it must be continued through the season. If it be once neglected, the plants will certainly be injured; for they are rendered so weak by the practice of shading, that they cannot bear the glare of the sun.

Some will deny this, alleging that plants not grown under glass, are never injured by the bright sun. But the reason of this is, that they are not confined and surrounded by hot air to scorch their leaves like those grown under glass. Moreover, glass affords some little shade, by excluding in every case a certain proportion of the sun's rays. For if glass were removed from plants grown under it, they would be burnt by the sun; and if glass were placed over plants unaccustomed to it, for a few days, and then removed, the plants would be scorched, as in the other case. This proves, that glass affords some degree of shade; and it must be injurious to plants grown under it, to shade them more than the glass does, except in particular cases. For it is well known, that melon and cucumber plants, grown without the protection of glass, do not thrive, except in hot sunshine.

It is not uncommon to see melon and cucumber beds shaded with mats from eleven till two o'clock, when the sun shines bright. But this is very injurious to the plants, as it affords them less light in the middle of the day than in the mornings and evenings. I have always observed that plants accustomed to much shade were very weak, and that they often received injury by the occasional neglect of shading; because, being used to this, they could not bear the hot sun. I am persuaded, then,

that melon and cucumber plants require no shading, except when very weak, or newly planted; provided, however, that plenty of air is admitted when the sun shines.

*Cossey Hall Gardens, Dec. 28. 1838.*

## REVIEWS.

ART. I. *Catalogue of Plants cultivated in the Birmingham Botanic Garden, arranged according to the Natural and Linnæan System; together with their Systematic and English Name, native Country, Time of Introduction, the Soil in which they thrive best, and where figured: also, a copious List of Synonymes, collected from the best Authorities.* Pamph. 8vo, pp. 16. Birmingham.

THIS catalogue has no date, but we presume it to have been printed in 1838, certain species being omitted in it which we lately saw in the garden. It contains the trees and shrubs arranged according to De Candolle's *Prodromus*, as far as *Cratægus* inclusive. We much regret that this catalogue was not put into our hands till we were just leaving the garden, otherwise we think we could have shown that some of the names put down in it as species are only varieties. For example, in p. 1. *Magnolia máxima* *Lod. Cat.*, which is only a variety of *M. acuminata* *L.*; and, in the last two pages, *Cratægus ovàlis* *Dec.*, *C. elliptica* *Ait.*, *C. caroliniana* *Lod. Cat.*, *C. salicifolia* *L.*, *C. lineàris* *Dec.*, and *C. prunifolia* *Willd.*, which, as well as several others, are all varieties of *C. Crús-gàlli* *L.*; and *C. xanthocarpa* *Hort.*, *C. præcox* *Swt.*, *C. Oliveriana* *Bosc.*, *C. eriocarpa* *Lindl.*, *C. monógyna* *Jacq.*, and *C. melanocarpa* *Willd.*, and others, which are only varieties of the common hawthorn. For proofs we refer to the article *Cratægus* in our *Arboretum Britannicum*, at the end of which are two lists, which we beg leave to quote for the benefit of all those who have purchased collections of *Cratægus* from Messrs. Loddiges, previously to the autumn of 1837, at which time the plants of *Cratægus* in the Hackney arboretum were replanted, and some changes then took place in the application of the names. We have also observed, in one or two collections received from Messrs. Loddiges, that some names have been inadvertently tied to the wrong trees; for example, in the Sheffield Botanic Garden, *C. maroccàna*, which is a variety of *C. Azaròlus*, is applied to a variety, if our recollection is correct, of *C. coccínea*.

“ App. iii. *Alphabetical List of Sorts of Cratægus in the Arboretum of Messrs. Loddiges, as given in their Catalogue, 16th edition, 1836; with some Additions, taken from the names placed against Plants in their Nursery, but not in the Catalogue; referred to the Species and Varieties of Cratægus as given in this work.*

“ The use of this list is to assist persons who have purchased collections of *Cratægus* from Messrs. Loddiges, according to the names of the 15th and 16th editions of their *Catalogue*, 1833 and 1836, in identifying them with our names. Most of the collections of *Cratægus*, not only in Britain but on the Continent, having been procured from the Hackney arboretum, we think this list will be of considerable utility both to nurserymen and amateurs. It is proper to observe, that the numerous synonymes in this list, and in that following (App. iv.), arise from the circumstance of Messrs. Loddiges collecting annually, from all quarters, whatever appears from the name to be a new sort, and growing the plants with the names attached to them which were received with them, for two or three years, till it has been clearly proved

whether they are really new or not. It is only by this practice that collections of any kind can be rendered complete.

"Those names which are applied to the same plants, both in the *Catalogue* of Messrs. Loddiges, and in the *Arboretum Britannicum*, are in small capitals.

Names placed against the Plants in the Arboretum of Messrs. Loddiges.	Names which the same Sorts bear in the 'Arboretum Britannicum.'	Names placed against the Plants in the Arboretum of Messrs. Loddiges.	Names which the same Sorts bear in the 'Arboretum Britannicum.'
altica.	purpurea.	odoratissima.	orientalis.
apiifolia.	apiifolia minor.	Oliveria.	Oxyacantha Oliveriana
major.	apiifolia.	orientalis.	Oxyacantha Oliveriana
arbutifolia.	Crus-galli splendens.	OXYACANTHA.	OXYACANTHA.
axillaris.	parvifolia.	APE'TALA.	APE'TALA.
AZAROLUS.	AZAROLUS.	AU'REA.	AU'REA.
betulaefolia.	parvifolia.	CAPITA'TA.	CAPITA'TA.
caroliniana.	Crus-galli prunifolia.	fl. pleno.	fl. multiplex.
carpathica.	nigra.	fl. roseo.	rosea.
Celsiana.	Oxyacantha Celsiana.	FOL. ARGE'NTEIS.	FOL. ARGE'NTEIS.
cerasifera.	Crus-galli splendens.	FOL. AU'REIS.	FOL. AU'REIS.
COCCI'NEA.	COCCI'NEA.	inclsa.	laciniata.
MA'XIMA.	MA'XIMA.	lutescens.	? lutea.
corallina.	corallina.	PE'NDULA.	PE'NDULA.
CORDA'TA.	CORDA'TA.	platyphylia.	melanocarpa.
CRU'S-GA'LLI.	CRU'S-GA'LLI.	PRE'COX.	PRE'COX.
cuneifolia.	nigra.	PUNJ'CEA.	PUNJ'CEA.
dentata.	Crus-galli ovalifolia.	REGI'NE.	REGI'NE.
Douglasi No. 1.	punctata.	STRI'CTA.	STRI'CTA.
DOUGLA'SII No. 2.	DOUGLA'SII.	tortuosa.	flexuosa.
edulis.	punctata flava.	PARVIFOLIA.	PARVIFOLIA.
elliptica.	Crus-galli ovalifolia.	pectinata.	Oxyacantha pteridifolia
eriocarpa.	Oxyacantha eriocarpa.	pentagyna.	purpurea.
fissa.	Aronia.	pterifolia.	Oxyacantha pteridifolia
FLA'VA.	FLA'VA.	pubescens.	tanacetifolia.
flavens.	punctata flava.	punctata.	pyrifolia.
florida.	parvifolia.	PURPU'REA.	PURPU'REA.
georgica.	spathulata.	pyracanthifolia.	Crus-galli pyracanthifolia.
GLAU'CA.	GLAU'CA.	pyrifolia.	Crus-galli pyracanthifolia.
glandulifera.	pyrifolia.	quercifolia.	Oxyacantha quercifolia.
GLANDULO'SA.	GLANDULO'SA.	radiata.	pyrifolia.
grossulariaefolia.	Crus-galli prunifolia.	salicifolia.	Crus-galli salicifolia.
HETEROPHY'LLA.	HETEROPHY'LLA.	sanguinea.	purpurea.
hybrida.	Crus-galli prunifolia.	sibirica.	Oxyacantha sibirica.
inclsa.	Oxyacantha laciniata.	SPATHULA'TA.	SPATHULA'TA.
indentata.	coccinea indentata.	spinosissima.	flava lobata.
ingestria.	? coccinea maxima.	splendens.	Crus-galli prunifolia.
Kilmansi.	Oxyacantha laciniata.	stipulacea.	mexicana.
laciniata.	parvifolia.	subvillosa.	glandulosa subvillosa.
linearis.	LOBA'TA.	TANACETIFO'LIA.	TANACETIFO'LIA.
LOBA'TA.	Crus-galli pyracanthifolia.	GLA'BRA.	GLA'BRA.
lucida.	MACRACA'NTHA.	tomentosa.	orientalis.
MACRACA'NTHA.	MACRACA'NTHA.	TRILOBA'TA.	TRILOBA'TA.
melanocarpa.	Oxyacantha (fructu rubro).	VIRGI'NICA.	VIRGI'NICA.
monogyna.	Oxyacantha monogyna.	viridis.	parvifolia.
napolitana.	? coccinea.	xanthocarpa.	Oxyacantha aurea.
NIGRA.	NIGRA.		

"In the above list, and in that which follows, there are one or two cases attended with some doubt, from the smallness of the plants; they being only received into the collection the last or the preceding spring, and having not yet flowered. The principal case of doubt is *C. lutescens* Lodd. *Cat.*; and we have accordingly put a point of interrogation before *C. Ox. lutea*, which we consider to be its synonyme. Before those names which we consider somewhat doubtful, we have also placed points of interrogation.

"App. iv. *Alphabetical List of the Species and Varieties of Crataegus described in the 'Arboretum Britannicum,' with the Names which are appended to the Specimen Plants of these Sorts in the Arboretum of Messrs. Loddiges.*

"The use of this list is to make known to intended purchasers of sorts of *Crataegus*, figured or described in the *Arboretum Britannicum*, under what names they must ask for them from Messrs. Loddiges. There are only a very few sorts not in the collection at Hackney, but we have indicated where they may be procured. There are very full collections of *Crataegus* in the Hamersmith Nursery, in the Fulham Nursery, in the Camberwell Arboretum, and in Mr. Donald's arboretum at Goldworth; but these collections are without a number of sorts which are contained in the arboretum at Hackney.

“Those names which are applied to the same plants, both in the *Arboretum Britannicum* and in Messrs. Loddiges's *Catalogue* for 1836, are in small capitals; and those taken from the Hackney arboretum *Catalogue*, where there are more synonyms than one, are in italics.

Names in the 'Arboretum Britannicum.'	Names in the Arboretum Hackniense.	Names in the 'Arboretum Britannicum.'	Names in the Arboretum Hackniense.
1. <i>apiifolia</i> .	<i>apiifolia</i> majör.	43. <i>OX. FO'LII AU'REIS</i> .	<i>OX. FO'LII AU'REIS</i> .
2. <i>minor</i> .	<i>apiifolia</i> .	44. <i>LACINIA'TA</i> .	<i>LACINIA'TA</i> .
3. <i>AZARÖLUS</i> .	<i>AZARÖLUS</i> .	45. <i>leucocarpa</i> .	We have not seen a plant of this variety, but there can be no doubt that it exists somewhere.
4. ( <i>Azarölus</i> ) <i>Arönia</i> .	<i>fissa</i> .	46. <i>lucida</i> .	There is a plant in the Hort. Soc. Garden.
5. ( <i>Azarölus</i> ) <i>maroc-cana</i> .	We know of only one tree of this sort in England, that in the Hort. Soc. Garden, of which there is a portrait in our Second Volume.	47. <i>melanocarpa</i> .	A plant of <i>Ox.</i> , with red fruit, has the name of <i>melanocarpa</i> attached to it.
6. <i>COCCI'NEA</i> .	<i>COCCI'NEA</i> .	48. <i>monögyna</i> .	<i>Ox. monögyna</i> .
7. <i>corällina</i> .	<i>corällina</i> .	49. <i>multiplex</i> .	<i>flöre pleno</i> .
8. <i>indentata</i> .	<i>indentata</i> .	50. <i>obtusata</i> .	Wanting. There is a plant in the Hort. Soc. Garden.
9. <i>MA'XIMA</i> .	<i>COCCI'NEA MA'XIMA</i> .	51. <i>Oliveriana</i> .	{ <i>Ox. Oliveria</i> .
10. <i>CORDA'TA</i> .	<i>CORDA'TA</i> .	52. <i>orientalis</i> .	{ <i>orientalis</i> .
11. <i>CRU'S-GA'LLI</i> .	<i>CRU'S-GA'LLI</i> .	53. <i>PE'NDULA</i> .	{ <i>Ox. PE'NDULA</i> .
12. <i>lineäris</i> .	<i>lineäris</i> .	54. <i>PRE'COX</i> .	{ <i>PRE'COX</i> .
13. <i>nana</i> .	We are not aware of there being any plants of this variety in the London collections.	55. <i>pteridifolia</i> .	{ <i>pteridifolia</i> .
14. <i>ovalifolia</i> .	<i>elliptica</i> .	56. <i>PUNI'CEA</i> .	{ <i>pectinata</i> .
15. <i>prunifolia</i> .	<i>caroliniana</i> .	57. <i>punicea fl. pl.</i>	{ <i>Ox. PUNI'CEA</i> .
16. <i>pyracanthifolia</i> .	<i>pyracanthifolia</i> .	58. <i>purpurea</i> .	There are plants in the Camberwell Arboretum.
17. <i>salicifolia</i> .	<i>salicifolia</i> .	59. <i>quercifolia</i> .	There are plants in the Epsom Nursery.
18. <i>spländens</i> .	{ <i>arbutifolia</i> .	60. <i>REGI'NE</i> .	<i>quercifolia</i> .
19. <i>DOUGLA'SII</i> .	{ <i>spländens</i> .	61. <i>rösea</i> .	<i>OX. REGI'NE</i> .
20. <i>FLA'VA</i> .	<i>DOUGLA'SII</i> No. 2.	62. <i>sibirica</i> .	<i>fl. rösea</i> .
21. ( <i>flava</i> ) <i>lobata</i> .	<i>FLA'VA</i> .	63. <i>STR'I'CTA</i> .	<i>sibirica</i> .
22. ( <i>flava</i> ) <i>trilobata</i> .	<i>lobata</i> .	64. <i>transylvanica</i> .	<i>OX. STR'I'CTA</i> .
23. <i>GLANDULO'SA</i> .	<i>trilobata</i> .	65. <i>PARVIFOLIA</i> .	There is a plant in the Hort. Soc. Garden.
24. <i>subvillösa</i> .	<i>GLANDULO'SA</i> .	66. <i>flörída</i> .	{ <i>PARVIFOLIA</i> .
25. <i>succulenta</i> .	<i>subvillösa</i> .	67. <i>grossulariæfolia</i> .	{ <i>axillaris</i> .
	There was in 1835, a plant of this variety in the Hort. Soc. Gard., which has since been removed.	68. <i>punctata</i> .	{ <i>betulifolia</i> .
26. <i>GLAU'CA</i> .	<i>GLAU'CA</i> .	69. <i>aërea</i> .	{ <i>flörída</i> .
27. <i>HETEROPHY'LLA</i> .	<i>HETEROPHY'LLA</i> .	70. <i>rübra</i> .	{ <i>edulis</i> .
28. <i>MACRACA'NTHA</i> .	<i>MACRACA'NTHA</i> .	71. <i>rübra stricta</i> .	{ <i>flava</i> .
29. <i>minor</i> .	We received specimens of a variety, to which we have given this name, from Somersford Hall.	72. <i>PURPU'REA</i> .	There are plants in the Hort. Soc. Garden.
30. <i>mexicana</i> .	<i>stipulæca</i> .	73. <i>altäica</i> .	There are plants in the Hort. Soc. Garden.
31. <i>nigra</i> .	<i>carpathica</i> .	74. <i>Pyracantha</i> .	<i>PURPU'REA</i> .
32. <i>orientälis</i> .	{ <i>odoratissima</i> .	75. <i>crenulata</i> .	<i>altäica</i> .
33. <i>sanguinea</i> .	{ <i>tomentösa</i> .	76. <i>pyrifolia</i> .	<i>Méspilus Pyracantha</i> .
	Wanting. There are plants in the Fulham Nursery under the name of <i>C. orientälis</i> .	77. <i>SPATHULA'TA</i> .	There are plants in the Hort. Soc. Garden.
34. <i>OXYACA'NTHA</i> .	<i>OXYACA'NTHA</i> .	78. <i>TANACETIFO'LIA</i> .	{ <i>SPATHULA'TA</i> .
35. <i>APE'TALA</i> .	<i>APE'TALA</i> .	79. <i>GLA'BRA</i> .	{ <i>geörgica</i> .
36. <i>aurantiaca</i> .	There is a plant in the Hort. Soc. Garden.	80. <i>Leedna</i> .	{ <i>TANACETIFO'LIA</i> .
37. <i>AU'REA</i> .	<i>OX. AU'REA</i> .	81. <i>VIRGI'NICA</i> .	{ <i>pubescens</i> .
38. <i>CAPITA'TA</i> .	<i>CAPITA'TA</i> .		{ <i>TANACETIFO'LIA GLA'BRA</i> .
39. <i>Celsiana</i> .	<i>Celsiana</i> .		There are plants in the Hammersmith Nursery.
40. <i>ERIOCA'RPA</i> .	<i>ERIOCA'RPA</i> .		<i>VIRGI'NICA</i> ."
41. <i>flexuösa</i> .	<i>tortuösa</i> .		
42. <i>FO'LIIUS ARGE'NTEIS</i> .	<i>FO'LIIUS ARGE'NTEIS</i> .		

After these lists in the *Arboretum* follow engravings of the leaves and fruit of all the species, and many of the varieties, of the *Crataegi* in British collections, of the natural size.

The trees and shrubs for the Birmingham Garden, as well as those for the Sheffield Garden, the Flitwick arboretum, the Chatsworth arboretum, and indeed all others that have been formed during the last twenty years, both in Britain and on the Continent, could only be obtained from Messrs. Loddiges, and in the collection of these gentlemen, it unavoidably happens that there

are many varieties designated as species, and many species repeated under different names. We say unavoidably, because what can any one do, who is collecting from all parts of the world, but plant the plants they receive, and place the names to them which have been received with them. In the meantime, the plants with these names are propagated and sold, and thus the greatest confusion is introduced in collections. Again we say that this confusion is unavoidable for a time. It might have been removed in a great measure by the Horticultural Society, and it is now beginning to be so; but it will require some time to reform the nomenclature of provincial collections. In the mean while gardeners and others, seeing plants so much alike with different names, puzzle themselves seeking for distinctions which do not exist; and often fixing on those which belong merely to the individual instead of to the species, the erroneous name is perpetuated, and the mind of the gardener or botanist is unsatisfied.

The genus *Cratæ'gus* is one of the few that we were able to settle in the *Arboretum* almost entirely to our satisfaction; and as in it we have given the lists of the names applied to the plants in the *Catalogue* of Messrs. Loddiges, edit. 1836, quoted above, and leaves and fruit of all the species of the natural size, those who possess our *Arboretum* will find little difficulty in applying the true names to each kind. Of upwards of ninety names applied to the plants of *Cratæ'gus* in Messrs. Loddiges's arboretum, there are only nineteen which we found correct, as indicated in the lists quoted above, and we have subsequently to the publication of these lists, in 1837, seen no reason to alter our opinion in a single instance. We might apply similar remarks to the other genera, of which there are numerous alleged species in catalogues.

To return to the *Catalogue* of the Birmingham Botanic Garden, we have to add, that it bears marks of having been done with very great care, many synonymes being quoted, and the authorities for every name given. We also observe that the specific names are generally literally translated, though not always, as in the case of *Gledítschia triacánthos*, which is made the honey locust. The page of the *Catalogue* being very broad, nearly  $1\frac{1}{2}$  in. more so than our *Hortus Britannicus*, the derivations of the generic names might have been given.

We make these remarks, confident that we have right on our side, and also that they will be taken in good part by those for whom they are intended. We could not have avoided making them, because the *Catalogue* being published subsequently to that part of our *Arboretum* which treats of the trees and shrubs mentioned in it, it became necessary to compare the two, and, had we assented to the application of the names which we find in the *Catalogue*, it might have been supposed that we felt ourselves to be in the wrong. We have another object in view in making these remarks. In the Birmingham Botanic Garden there is generally allowed to be the best collection of hardy herbaceous plants in Great Britain; and, as a catalogue of these will doubtless be published by the same party, we are anxious that they should thoroughly reform the species and varieties. To do this would be to render a very great service to practical botanists and gardeners, and to have rendered such a service will be no small honour to the Birmingham Botanic Garden.

---

ART. II. *Catalogue of Works on Gardening, Agriculture, Botany, Rural Architecture, &c., lately published, with some Account of those considered the more interesting.*

SECOND additional Supplement to Loudon's *Hortus Britannicus*: including all the Plants introduced into Britain, all the newly discovered British Species, all the Kinds originated in British Gardens, up to March, 1839; with a new general Index to the whole Work, including all the Supplements. Prepared under the direction of J. C. Loudon, by W. H. Baxter; and revised by George Don,

F.L.S. 8vo; pp. 601. to 742., exclusive of a new titlepage to the volume. London, 1839.

This most laborious work, which has been upwards of a year in hand, is at last completed; and we hope it will be satisfactory to those for whom it was intended. The total number of species enumerated in the *Hortus Britannicus* is now 31,738.

*Report of the Committee of the Society for obtaining free Admission to National Monuments, and public Edifices containing Works of Art.* Pamphlet, 8vo. London, March, 1839.

This is a very interesting pamphlet; first, as showing who among the peers and members of the House of Commons have taken an active part in an attempt to extend opportunities of "mental recreation and development among the people;" and next, as showing what the committee have already done. The Duke of Sussex is the president of this Society, Mr. Hume the chairman of the committee, and Mr. George Foggo the honorary secretary. The pamphlet contains a list of institutions in England and Scotland to which the public are already admitted without any payment, amounting to nineteen; an announcement that the fees usually paid at the Tower have been reduced; and notices of some other institutions expected to become more liberal. The reluctance of the Dean of Westminster, the Royal Academy, and a few others, to advance the public taste and civilisation, is deplored. The committee "lament to find the London College of Surgeons, and the council of the University College, unwilling to follow the noble example of the Royal College of Surgeons at Edinburgh; and that they consider the present restricted mode of admission to their museums quite sufficient. The fine botanical garden near Sheffield, also, as it belongs to a company of shareholders, affords no hope." (p. 6.)

The public are greatly indebted to this Society, which, we hope, will continue its labours till it has thoroughly liberalised the minds of the directors of public institutions; and, afterwards, it may perhaps direct its attention to private collections of works of art, and private gardens and pleasure-grounds. A list of country seats, noticing whether the house is shown, and on what conditions, and what it contains worthy of being seen, would be a valuable document, and be the means of rendering justice to those landed proprietors who so nobly open their houses and gardens to the public. It would be very desirable, if the gratuities which it is customary to give at such places as Blenheim could be reduced to the higher classes, and if certain days could be set apart for showing the houses and grounds of such places gratis to the people. The mere discussion of this subject, accompanied by its statistics, would do much good; because the idea of interfering in the slightest degree with the practice of individuals, in matters of this kind, is altogether out of the question.

*Suggestions on National Education, with a View to the Advantage, not of the Poor only, but of all Classes of Society.* By John Smith. Pamph. 12mo, pp. 35. London.

Our readers will, perhaps, recollect some observations of ours under the head of Horticultural Exercises for Schools, in p. 288. In the little book, the title of which is given above, we were agreeably surprised, among other excellent things, to find the following paragraphs, as part of suggestions of "the Means by which the Government may show the Public what Education really is, and the best Modes of carrying it forward."

"I advise, then, that an estate, in some central part of the kingdom, be purchased, for the purpose of erecting buildings, and laying out suitable grounds for a model, or state school (which should, by all means, be a boarding school), for about four hundred boys. I propose a central situation, that it may be easy of access; but I hope many similar establishments would soon

arise in various parts of the three kingdoms; and I name a boys' school in the first instance, because, after it is in full operation, it would be easy to institute an equally useful model school for girls, in which education might be rendered as practically suitable for them (a most desirable thing for the country), as the original one would be for the boys."

After various details, the following paragraphs occur:—

"Surrounding all the play-grounds, and, therefore, at a convenient distance from the school, there should be a number of workshops, in which artificers in all the most mechanical and scientific branches of business should be employed, chiefly with a view of teaching young persons the ordinary use of tools, the operation of the mechanical powers, and the nature of materials generally. It is sometimes said of a clever young fellow, "Oh! that lad, if he were turned out penniless on a common, would make his way in the world." This is said because, under some favourable circumstances, he has early acquired an aptitude for a variety of things. Here then would be an opportunity of conferring such aptitude upon many; and its use in inducing muscular action, and proving the profitableness of exertion, would be its first advantage. Youth *will* have work, that is to say, exercise for the limbs; and instead of throwing stones at birds, pulling down palings, or wrenching gates off their hinges, let them have useful, and yet agreeable, opportunities of exercising their animal powers. But let them not be *driven* to those schools of industry—the proposed workshops. On the contrary, it must be a privilege to enter them, contingent upon good behaviour. Alfred has been so attentive that he may assist the joiner in repairing his own box, or in making himself a small chest of drawers, at appointed hours. Charles has so diligently applied himself to his duties, that he may assist the mathematical instrument maker in turning the tubes, and grinding the glasses of a little telescope. Henry may help in taking to pieces the model steam-engine, and in preparing it anew for action. William may be permitted to assist the smith in making a little plough for himself, for he and some of his intimate friends are to be farmers, and they are about to assist the husbandman in preparing a plot of ground for seed. In the various workshops some of the pupils would, of course, acquire, and would manifest, a preference for particular employments; and in one spacious apartment a swimming school would contribute to their health, their enjoyment, and future safety.

Beyond these, and enclosing the whole, a moderate breadth of land should form the margin of the estate, and should be ample enough, not only for the purposes of so much instruction in agriculture and gardening as every respectable person ought to receive, but to supply the school with sufficient produce. Here the pupils, whether in the botanic garden, the kitchen-garden, the corn field, the potato ground, or the meadow, would be indulged with strength-inparting exercise for the body; while the mind, agreeably to the dictates of nature and religion, would be receiving practical lessons, calculated to make man the *prospective* being which he ought to be, as to the effect of his present actions. Even the earth will, in due season, record the effect of his forethought and exertion; let him trace from this the grand truth that, in the moral, as in the physical world, the great Creator of that earth has willed it, that we shall reap even as we sow."

The present government, we believe, is willing to act on the suggestions of Mr. Smith and others, and to establish normal schools; but when they will have sufficient power to carry their intentions into execution is very uncertain. It is a great point gained, however, to have the subject so prominently brought forward; because that will end in rendering the public mind aware of its immense importance, which is very far from being the case at present.

---

#### ART. III. *Literary Notices.*

*REPTON'S Landscape-Gardening*, being the whole works of the late Humphrey Repton, Esq., with a biographical notice, and notes, is now ready; and



No. I., price 2s. 6d., will appear with this Magazine on July 1. It will be completed in twelve numbers; and, as the price will, in all probability, be raised after completion, we recommend gardeners to take it out in numbers. The coloured copies will be 7s. 6d. each, but they will not be issued till August 1. The published price of Mr. Repton's works was upwards of 20 guineas, viz. *Sketches and Hints*, 2l. 12s. 6d.; *Observations, &c.*, 5l. 5s.; *Changes of Taste, &c.*, 5s.; *Gardens of the Pavilion at Brighton, &c.*, 6l.; and *Fragments, &c.*, 6l. All these works, with copies of all the engravings, without a single exception, the public may now purchase in one 8vo volume, which, if taken out in numbers, will be only 1l. 10s.

*Waterton's Essays*, of which a new edition has just been published, contains a valuable and most original article on the use of weasels in gardens.

## MISCELLANEOUS INTELLIGENCE.

### ART. I. Foreign Notices.

#### ITALY.

*CULTURE of the Truffle.* — I mentioned in my former letter (see p. 192.) that truffles had refused to yield to any sort of cultivation that our gastronomes could contrive; yet some writers on horticulture, and among others Count Philip Re, state, on the authority of the historian John Baptist Giovio of Como, that Giovio's cook throwing the scrapings of truffles in a certain spot of his garden, according to custom, there was found, to the great surprise of all, a complete truffle bed! After this, many others tried this method of sowing them, but without success.

*Culture of the Mushroom.* This is not the case with mushrooms, although the growers of them are few, because the Italians prefer eating them when Nature gives them spontaneously; and, to say the truth, she is by no means sparing in this respect, for they are produced in such abundance, that during the season a pound of the finest mushrooms (the Milanese pound is equivalent to 1 lb. 11 oz. of your weight) may be had for 5 soldi (about 2d. English). To secure them for the winter, they are dried in the sun and kept in paper bags under the cover of the kitchen stove, or the hat-shaped fungi (*pilei umbraculi*) are made into sauces, and used as they are wanted. The Marquis Francis Cusani communicated to me, some time ago, the method practised by the inhabitants of the neighbourhood of Salò, called the Riviera, of cultivating mushrooms; and, as I consider it of some importance, I send it to you. In the district of Salò there grows a great number of laurels (*Laurus nobilis*), of the berries of which an oil is made, which, as you know, is used in the manufacture of cloths, and particularly those of Schio (a town in the Lombardo-Venetian kingdom, province of Vicenza). The proprietors, who trade in them, after crushing the berries in the press, leave the refuse in heaps, making use of it for manure. Ten or twelve years ago, some one observed that his heaps of crushed berries produced tufts of fungi, and he wished to try whether they were poisonous or not. The experiment was first tried on dogs, when they were found to be innocuous; then the thought arose of forming artificial mushroom beds, and, after various attempts, they were ultimately constructed in the following manner: —

A situation was chosen between the west and the north, in a soil free from clay, when a trench was dug 3 Milanese braccie square, (5 ft. 9 in. of your measure), and 2 braccie (3 ft. 10 in.) deep. The bottom of the trench was beaten down, so as to render it hard, then a layer of crushed laurel berries was laid in it, which was also beaten down; after which a layer of earth and proceeding in the same way, always beating down, till about four layers of earth and berries had been deposited, when the trench was filled to a level with the soil. In the space of a year, in October, the mushrooms appear two or three in a

tuft; they are hard, of a blackish colour, very savoury, and preserve something of the aromatic flavour of the laurel.

The mushroom beds last three years, after which period they decline, and scarcely produce any fruit the fourth. For this reason, the proprietors prepare new ones every year, so as to be always supplied with them. Although the climate is very mild in the Riviera, yet the mushroom beds are covered with straw. The expense is trifling, as the berries cost nothing, and the labour for digging the trench and beating down is calculated at about 4s. 3d. English.

The Marquis Cusani, before mentioned, assures me that he has eaten these mushrooms frequently at Salò, while he saw them gathered in the gardens of several gentlemen, and that he found them exquisite, and by no means unwholesome. He could not tell me, however, of what species they were. At present this branch of culture is rather neglected, the country producing abundance of mushrooms naturally.

*The Garden of Baron Zanoli, and of M. Ulrich.* I have been invited to see the garden of Baron Zanoli, situated on the high road from Monza to Milan, in which I am told there are fine exotic trees and shrubs, and especially a rich collection of pinuses. I have accepted the invitation, and shall go there very soon, when I shall communicate to you the result of my visit. In the meantime, in accordance with my promise, I send you the list of the plants which have been introduced during the past year, 1838, by M. Moses Mavari, gardener to M. Ulrich, in Milan, whose garden you speak of in the *Gardener's Magazine*, vol. xiii. p. 56. These are, *Clématis cærúlea grandiflora*, *C. bicolor*; *Caprifólium occidentale*, *C. longiflorum*; *Lonicera Ledebouriana*; *Philadelphus Gordónii*; *Deutzia cænescens*, *D. scabra*, *D. undulata*; *Leycesteria formosa*; *Garrya elliptica*; *Spiræa Nilondiéstii* (?). *S. nutans*, *S. grandiflora*, *S. laurifolia nova*, *S. argentea*, *S. japonica*; *Cytisus Philippii* (?); *Genista ephedroides*; *Fuchsia fulgens*; *Euphorbia jacquiniæ-flora*; *Aquilegia glandulosa*; *Potentilla Garneriana*; *Cupressus triquetra*; *Cosmèlia rubra*; *Dracophyllum secundum*; *Tecoma jasminoides*; *Vaccinium ovatum*; *Andrómèda tetragona*; *Anigozanthus retusus*; *Chorozema cordatum*; *Anthocarya* (?) *nova species*; *Arbutus tomentosa*; *Ipomœa purgans*, *I. Horsfallii*, *I. anotheroides*; *Corræa rubra*; *Epimedium macranthum*; *Ligustrum laurifolium*; *Lilium fulgens*, *L. carolinianum*; *Pterocarya caucásica* (*Juglans fraxinifolia*); *Pæonia álba Vevèsii*, *P. Póttssii álba*; *Passiflora Hibbertii*, *P. Mayana*; *Ribes Grossularia monstrosa*; *Sedum Sieboldii*; *Lýchnis Flóscuculi fl. pleno álbo*; *Pentstemon argutus*, *P. gentianoides*, *P. latifolius Campánula verbascifolia*; *Aràlia japonica*; *Siphocampylos bicolor*; *Berberis dâlcis*, *B. vulgaris fól. purpureis*; *Mahonia glumacea*; *Verbena Tweediana*; *Juniperus suécica pyramidalis*, *J. recurva*; *Pinus insignis*, *P. Stròbus excelsa*, *P. Str. Lambertiàna*; *P. Str. monticola*, *P. Str. compressa*, *P. Palmieri* (?), *P. índica* (?), *P. sinensis*, *P. Gerardiana*, *P. sylvêstris uralensis*, *P. nootkatensis*, *P. Llaveana*, *P. Sabiniàna*, *P. Sab. major*, *P. Sab. varietas*; *Picea Pin-drow*, *P. Webbiana*, *P. religiosa*; *Abies Fórsteri*, *A. Novæ Hollandiæ*, *A. Morinda*, *A. Douglàsii*; *Quadrifaria imbricata* (*Araucaria imbricata*); *Araucaria excelsa*, *A. Cunninghamii*; *Cedrus Deodara*; *Dammara orientalis*; *Azalea índica eata n. pleno*, *A. i. Smithii coccinea*, *A. i. salmon-coloured*, *A. i. pulchra*, *A. i. rubra plena*, *A. i. cærulescens*, *A. i. superba duplex*, *A. i. caryophyllea*, *A. i. aurantia grandiflora*, *A. i. Diána*, *A. i. Cunninghamii*, *A. i. Danielsiana*, *A. i. Hoókeri*, *A. i. ignescens*, *A. i. lactea floribunda*, *A. i. lateritia*, *A. i. longifolia*, *A. i. Mazéppa*, *A. i. nerifolia*, *A. i. Préssii*, *A. i. Rawlinsoniana*, *A. i. rotundifolia*, *A. i. superba venusta*, *A. i. Simsiana elegans*, *A. i. Simsiana*, fine dark purple, *A. i. speciosissima*, *A. i. triumphans pulchra*, *A. i. variegata*, *A. i. pulcherrima*, *A. i. white perfection*, *A. i. álba fl. pl.*, *A. i. Woodfordiana*; *Rhododéndron arboreum Cunninghamii*, *R. a. Norbertianum*, *R. a. superbissimum*, *R. a. Wiltónii*, *R. a. Ketelerianum* (?), *R. a. fromontianum*, *R. a. Cartonii*, *R. a. enneandrum*, *R. a. carnosum roseum*, *R. a. idlesdiense* (?), *R. a. grandissimum Smithii*, *R. a. tigrinum*

Smithii, *R. a. macranthum roseum*; *R. a. campanulatum hybridum*, *R. catawbiense* fl. pl., *R. Farreri*, *R. ponticum hyacinthinum*, *R. ponticum album multiflorum*, *R. p. guttatum*, *R. p. Löwei*, *R. p. flore picto* Cunninghamii, *R. p. carneum multimaiculatum*, *R. p. strictum*, *R. caucasicum*, *R. Chamæcistus*; *Camellia japonica* Grand Frederick, C. j. tricolor elegans, C. j. King, C. j. Eliza, C. j. Admiral Nelson, C. j. Hosackia vera, C. j. ochroleuca, C. j. Collétti, C. j. Palmer's perfection, C. j. triumphans, C. j. triphora (?).—*Giuseppe Manetti. Monza, June 1. 1839.*

## ART. II. Domestic Notices.

## ENGLAND.

*THE Kent Zoological and Botanical Gardens*, which are situated at Rosher-ville, near Gravesend, were opened to the subscribers in the beginning of May last. Non-subscribers are admitted at 1s. each, children at 6d. each; servants having the care of children under fourteen years of age, to be admitted on payment of 6d. each, and pupils of schools on payment of 10s. 6d. each annually. None but subscribers and their orders are admitted on Sundays. The closing of places of this description to the public generally on Sundays is, in our opinion, a matter much to be regretted; for on what other day of the week can a working man enjoy a walk in a public garden with his family? Being excluded from all recreation of this kind, the working man naturally has recourse to the public-house; or, perhaps, he drinks and smokes at home. All public gardens, in our opinion, ought to be as free on Sunday to the poor as they are to the rich. The Kent Society were not bound to open their garden to non-subscribers at all unless they chose; but, having done so, we think their excluding non-subscribers on the Sundays is a measure too aristocratic, and very impolitic, if the improvement of the working classes of Kent is any object with the Society. — *Cond.*

*Importation of Cacti.*—The cargo of plants mentioned in my last letter is just come to hand in the most perfect condition. There are only two cases of Cacti, but of Orchidææ we have no less than twenty-six cases; many of the orchidaceous plants are beautifully healthy specimens, and quite new to Messrs. Low and Henchman. One Epidéndron is quite unique; it has a strong woody rhizoma, or what you might call an ascending woody stem, with a large pseudo-bulb at each joint; these bulbs are in the way of Epidéndron tibicinis. There are many fine plants of this species ready to burst open their buds, and in a beautiful state of preservation. It must be a fine-flowering sort, as M. Kenzie, our most indefatigable collector, mistook it for a fine species of Cattleya. Of this latter genus we have abundance of plants, supposed to be of the best kinds, and some of them altogether new to us. This is the case also with some of the Orchidææ; the rest are of the best species of the old established kinds. We have hardly a plant in the whole lot of the weedy kinds; though you are, no doubt, aware that there are more weeds among the orchidaceous plants than in any other family whatever; but, on the other hand, we have the finest flowering plants of the vegetable kingdom in this family.

There is a very increasing demand now for Orchidææ, as a proof of which I may mention that several gardeners from the country were anxiously waiting at Clapton till the plants were divided, in order to buy up such as were new to their collections; but this circumstance may be accounted for by the number of country gardeners who came up to the exhibition of the Horticultural Society last Saturday. Among a large assortment of seeds we have several of great promise; such as those of allied genera to the rhododendrons, hitherto known in this country only by dry specimens. Altogether, we have reason to be much satisfied.

Of Cacti, we have good plants of five or six species of Cereus; Melocactus micracantha and communis comprehend our melon-shaped lot; and of Mamillaria we have only one species, M. glomerata.

I send you in a box a few insects which destroy seeds in abundance; they must be of the weevil kind; perhaps they may be of interest to some of your friends. Mr. Westwood, perhaps, could say the best way of guarding seeds from their depredations. — *D. Beaton, Kingsbury, June 20, 1839.* [We have sent the insects to Mr. Westwood, and his report will be given in next Number.]

*Laburnums blossoming Twice in the Year.* — It may not be an uncommon circumstance, but I certainly never remember before this year to have seen the common laburnum cut off by the frost. I have many trees, but not one of them came into blossom. Six years ago they blossomed quite as profusely in August as they did in spring. — *W. S. B. Grove Parsonage, Wantage, June 20, 1839.*

*Danish Gardeners in England.* — M. Weilbach has lately arrived here to study his profession, strongly recommended by M. Moersch, curator of the Royal Botanic Garden at Copenhagen, and by Professor Schouw. There are two other Danish gardeners now in England, M. Lona and M. Petersen, all the three having been pupils of M. Moersch. M. Petersen's brother, now the court gardener at Rosenberg, near Copenhagen, passed several years in England, and on his return to Denmark introduced many improvements, as noticed in our preceding volumes. The circumstance of three or four Danish gardeners having each studied some years in England, returning to their native country, and filling conspicuous situations, can hardly fail to render horticultural improvement general. We wish we could see the practice followed by the Russian and Swedish governments. — *Cond.*

#### SCOTLAND.

*Doryánthes excélsa* is now in full bloom in one of the hot-houses at Dunkeld gardens. The plant is one of four which were sent from New Holland to the Duchess of Athol twelve years ago, and the only one that survived the voyage. The scape is upwards of 12 ft. in height, from the top of which diverge seven stalks, each bearing nine large flowers of a deep crimson and pink colour. The formation of the stalks, and outer petals of the flower, remind one of the *Crinum amabile*, but much larger. The gardener had no communication as a guide to its culture, but kept it at all times, and in all seasons, associated with the most hardy green-house plants. (*Dunkeld Gardens, May 24.*, as quoted in the *Caledonian Mercury, June 1, 1839.*)

*Douglas's Monument.* — The committee expect to come to a final determination on this subject in the course of July. — *Cond.*

---

#### ART. III. Visits to Suburban Gardens.

*STAFFORD House Flower Hall, June 12th.* — This hall, which is intended for the exhibition of plants in pots competing for prizes, appears to us to be well adapted, both in design and construction, for the object in view. The building stands north and south, and the light being admitted only from above, from windows in the upper part of the side walls, the plants will be seen to the greatest advantage; and supposing the show table to be placed along the centre of the hall, the plants may be placed upon it in a sufficiently isolated position to be viewed individually, and on both sides. This, we think, ought to be the case with all plants exhibited to display the effects of extraordinary care and culture; except in cases where a plant has been trained to a flat surface, and exposed to the sun only on one side, when the flowers will be produced on that side only. Plants of this kind may be placed on a table against a wall, or anywhere else, where the best side can be seen to the greatest advantage. Plants, also, which are exhibited merely for their rarity, may be placed in masses, or in any other manner in which they will present only one surface, or even a part of the plant, to the spectator; because the object, in this case, is merely to show as much as may determine the

character of the species, not the effect which has been produced on the individual plant by extraordinary culture.

This hall is certainly far better adapted for exhibiting plants to advantage, than any tent or other structure that we have seen in the neighbourhood of London; and we only wish it were three times as long as it is, and placed adjoining and connected with the gardens of the Horticultural Society, in order that that body, and the Stafford House establishment, might hold their exhibitions in it alternately, and that the Horticultural Society's garden might be no longer disfigured with the skeleton tent, which is a most unmeaning object nine months in the year, when not covered with canvass. We can easily foresee the superior degree of effect and comfort that will attend the exhibitions in the Flower Hall to those in the Horticultural Society's tents; or, indeed, to exhibitions of flowers in any tents whatever. Independently of the bad light which is unavoidable in them, no tent can be contrived to exclude the heat to the same degree as a structure of masonry like the Flower Hall; which, by being syringed with water inside and out, the evening before the flower show, might be rendered, if it were desirable, almost as cool as an ice-house. We have one fault to find with this building, which is, that there are only two doors at the ends, instead of three. We presume the reason to be, that three are not required for use; but we submit to the public mind generally, whether, in the building before us, three are not required for effect. Something also might be said about the tie rods; but great allowance ought to be made for the haste with which the whole was got up. Perhaps we may return to the subject, and illustrate our ideas by sketches.

Though we have found only one fault with the Flower Hall itself, we have nothing but faults to find with the manner in which the ground round it is laid out. The general outline of the plot is a parallelogram lying in the direction of north and south, containing, perhaps, an acre, and the surface is flat, enclosed with a brick wall, and without any prospect. The Flower Hall itself is a parallelogram, and it is very properly placed in the middle of the plot. Now the question is, how is the ground between this building and the boundary wall to be disposed of? In our opinion, the Flower Hall ought to have been placed on a platform of turf, raised at least one step above the general surface of the ground; and between this platform and the boundary wall, there should have been, first such a breadth of lawn as the space would afford; then, all round, a straight broad gravel walk parallel to the Flower Hall and the boundary; and, lastly, a border, chiefly of evergreen shrubs, to disguise or conceal the brick wall. This, in our opinion, is all that was necessary, and all that can be made of such a limited space, consistently with unity of design and expression. But, instead of this, there is no platform raised for the Flower Hall. The walk between it and the boundary wall is of the serpentine kind, and there is a curvilinear border of shrubs to disguise the boundary. This taste we consider to be at variance with the obvious principle, that the lines and forms immediately surrounding any building should partake of the lines and forms of that building: and it is, we are certain, contrary to the principles of utility; for what can be more inconvenient for persons visiting this Flower Hall, who will naturally walk round it in parties to talk of the exhibition, than to have their attention distracted from what they have seen, by the necessity of guiding their steps along the windings of a walk, however broad it may be? It is true that the whole work has been got up in a hurry, and this is an excuse for errors in execution; but it is no excuse whatever for the errors in the design, which, we contend, are here displayed to a degree which, considering the well known taste of the architect (Mr. Hakewell), and the liberal expenditure of the proprietor, deserves severe reprobation. We consider it the more necessary to point out what we consider to be erroneous in the laying out of this piece of ground, since it shows an indiscriminate imitation and adoption of a style of laying out grounds which, though the fashion, and admirably adapted for grounds of considerable extent, is, we think, altogether unsuitable to the case

before us. There is yet time, however, for changing the whole; and we shall be glad either to see this done, or to hear what arguments can be advanced in favour of the plan adopted. Further, if we should be furnished with a plan of the grounds in their present state, we shall be happy to publish it, along with another plan embodying the ideas which we have above hastily sketched out. We have taken a sketch showing the twistings of the walk on the west side of this hall, which, were we desirous of caricaturing the garden, we should publish; but we have no such intention. Our object is to do good; and we think that this hall might, with very little care and expense, be rendered a model for structures of the same kind about the metropolis, and also in other places.

*Whitton Park; George Gosling, Esq.*—A person must be as fond of trees and shrubs as we are, to conceive an idea of the pleasure that we experience when looking over this fine old place. Some large trees were blown down during the hurricane of January 7th, but none of any value, except a deciduous cypress, the dimensions of which are given in our *Arboretum*, vol. iv. p. 2487., as 81 ft. high, with a trunk of 5 ft. in diameter at 3 ft. from the ground. One or two large cedars were also blown down, and some gigantic silver firs and Scotch pines. The fine specimens of *Carya olivæformis*, and *C. porcina*, are uninjured and coming into bloom. *Quercus E'sculus*, of which there are the finest specimens in England, and most of the American oaks, are in good foliage, though *Q. Phellos*, of which there is an immense tree, has not quite recovered from the effects of the cold of the winter before last. One great charm of this place is the undisturbed state in which the woods appear to have been long kept, in consequence of which some most singular groups of trees have been accidentally formed: for example, close by the house, five oaks have sprung up from the root of a cedar, probably from acorns deposited there by squirrels, with which this park abounds, and their branches mingling with the arms of this tree form a very grand, singular, and picturesque mass. In other places, the sycamore, the ash, the elder, &c., have sprung up at the roots of cedars and formed groups with them. Many of the trees ripen their seeds, which come up; and, though most of them are killed by some means or other, yet some survive and become trees. The lower branches of the immense Lombardy poplar, which, in February, 1835, was 115 ft. high, with a trunk 19 ft. 8 in. in girth at 2 ft. from the ground, is in most vigorous growth, and the lower branches are assuming the character of those of a round-headed tree, as different from those of the upper part of the tree as the flowering branches of ivy are from the ordinary shoots. It is singular that the seedling cedars die on the cedar mount here, precisely for the same reasons that they die on Mount Lebanon, viz., that the decayed foliage of the cedars forms such a thick stratum, that the roots of the seedlings do not receive sufficient moisture, and the plants consequently wither off the first year. (See *Arb. Brit.*, article Cedar.) We must stop abruptly, however, for when speaking of this place it is difficult to tell where to leave off, without going through the whole, and this would fill a magazine. We were gratified on our present visit with a sight of the plan of the grounds as they existed in the time of the Duke of Argyll, and the present proprietor has kindly permitted us to take a copy of this plan, and also to make a plan of the grounds in their present state. With these, and some views which we have had taken, we intend to illustrate an edition of Whately's *Observations on Modern Gardening*, for which we have long been collecting notes, plans, and sketches, and in furtherance of which we would earnestly entreat our readers to lend us their assistance.

*Teddington Grove.*—The house was built by Sir William Chambers, who may be supposed to have had something to do with laying out the grounds, for they are exquisitely beautiful, and their effect has been greatly heightened by the very superior taste and assiduous care of the present possessor. Though these grounds can have had scarcely any variety of surface naturally, yet they have been slightly hollowed out in some places and raised in others,

so as now to indicate some beautiful inequalities, greatly heightened by the manner in which the trees and shrubs are disposed on them.

The lesson to be learned from Teddington Grove is, how to unite the beauties of a young place with those of an old one; that is, how to produce thriving roses, dwarf American shrubs, select kinds of young trees, and beds of green-house or hardy flowers, among fine specimens of old trees and shrubs, and without destroying deep shady groves. This has been done by opening glades in some parts, and in others by taking advantage of glades already existing; and the great merit of the whole is, that, wherever these flowering shrubs or flowers have been introduced, the ground has been so thoroughly prepared, and the position so judiciously chosen with respect to light and air, that all the plants grow with the greatest vigour. In consequence of this union of youth and maturity, of the endless variety in the disposition of the groups and masses of trees, and of their numerous kinds and sizes, we do not know any other place of the same extent which contains so much beauty within itself, independently of the delightful views of the Thames, Richmond Hill, and the varied line of hilly and wooded country on the opposite side of the river. Among the remarkable single trees and shrubs are, a very large variegated common oak; a very handsome *Magnolia tripetala*, upwards of 20 ft. high, and now covered with flowers; a *M. acuminata*, a handsome pyramidal tree 50 ft. high, also covered with flowers; some immense Portugal laurels; and a box tree forming a mass 36 paces in circumference and 20 ft. high. There are large Judas trees now beautifully in flower, snowdrop trees, catalpas, scarlet and double blossomed thorns, a large red cedar, a large cedar of Lebanon, a very fine evergreen cypress, and a great many other fine specimens, besides immense masses of rhododendron now covered with bloom, azaleas, China roses, &c. The style in which the walks, flower-beds, and edgings are kept is entirely to our taste; and, indeed, the order and high keeping of every thing else appeared to us so exquisite, that we could not find a fault. In short, Teddington Grove is, in our opinion, a model for a small place, not only in laying out and planting, but in progressive improvement and keeping. We say progressive improvement, because no person can have the full enjoyment of a villa that is not continually doing something to it, or looking forward to something that is to be done. In this, as in almost every thing else, to cease to labour, is to cease to enjoy. But, as we intend, on some future occasion, to give a ground plan and some views of this place (having for this purpose received the kind permission of the possessor), our further remarks on the present occasion shall be brief.

The roses and other ornamental plants in the flower-beds are beautifully healthy and vigorous. The front of the green-house, which is an ancient architectural one, but still with a glass roof, is shaded by letting down an awning in front, like that used for shading shop fronts; and under the glass roof an awning is suspended over the flowers, in the same manner as it is done over the company in Italy when they are assembled in very lofty rooms in the winter season. These awnings at Teddington Grove are used, not to shade ordinary green-house plants, but fine specimens in flower brought from the reserve green-houses or pits in the kitchen-garden. In short, they are used for the same purpose as the rustic orangery in the Dutch garden at Redleaf. (See p. 366. and 367.) The principal specimens in the house at this time are, a fine collection of calceolarias, another of pelargoniums, some splendid schizanthuses, of which some new varieties and hybrids have been raised from seed, which will be noticed in Mrs. Loudon's *Ladies' Flower-Garden of Ornamental Annuals*, and various other plants of the season, all cultivated to a very high degree of perfection by the gardener, Mr. Bare, to whose skill and care, superintended by the exquisite taste of his employer, Teddington Grove owes all its floral beauties.

In the flower-garden in front of the green-house, we observed a practice which we think well deserving of imitation, viz. that of setting down pots of fine single specimens of green-house plants on the lawn, and then surrounding and covering the pots with stone-work, vitrified bricks, flints, or even grotesque roots. The contrast between these little rocky masses or groups, and the

softness and smoothness of the lawn, and the finely raked earth of the beds, is very effective; and in walking through among the beds, where these rocky protuberances occur, they form excellent foregrounds to what is beyond them.

What we particularly admire about Teddington Grove is the situation of the house. It is a square mass, completely isolated, without the appearance of offices of any kind, and with nothing in it, or about it, not even a servant's window in the basement which requires to be concealed. We could fancy it a temple in a wood, from the absence of every thing like offices; and the certainty that these are not there and concealed by trees, abstracts the vulgar part of the ideas which generally arise on the view of a dwelling-house, whether large or small, a palace or a cottage. The principal floor is 6 or 8 feet higher than the level of the lawn; and, in the centre of the lawn front, a portico projects from the centre drawingroom window, and opens to a double flight of steps, which adds to the temple-like effect, and seems to indicate the enjoyment which may be had by descending to the lawn. All this effect depends on the form and isolated position of the house, and not on its architecture, which is altogether without pretension. The whole of the grounds seems so admirably adapted to the house, that the idea never occurs for a moment that it would have been better situated any where else. From every point of view it appears backed by wood, and yet there is not a single tree on any side within 50 or 60 feet of it. This contributes greatly to the healthiness of the house, by allowing the sun to shine freely on every front, and also the free action of the winds, by which the walls are kept dry without, and the rooms cheerful within. We cannot bring ourselves to approve of the prevailing custom of covering part of a house, and, at all events, the offices, with trees and bushes placed close to the walls. We would show the whole pile of building, and have no tree or shrub nearer any part even of the offices, than 20 or 30 feet, except, indeed, in very small places. The fashion of covering up offices in the manner generally practised does not appear to have originated in any principle of utility, but is rather to be considered as a fashion introduced with the change of taste in laying out grounds, which took place about the beginning of the last century, and is continued by the custom which has prevailed since the time of Gilpin, of considering the picturesque as the principal beauty to be studied in the exterior of country houses, and in laying out the grounds around them. We admit that, to a great extent, picturesque beauty is that which ought to be principally studied; but we think that, in planting trees and shrubs about a house, it is commonly too much so for health, and dignity of effect. The nice point is, to conceal the offices of a dwelling-house without seeming to do so, and without darkening any of the windows, or rendering any part of the building damp, inconvenient, or unhealthy. It is chiefly in dry gravelly soils, that the domestic offices can be concealed under ground, or contained in the body of the building, as at Clermont and Teddington Grove, and the character of the house thus ennobled, and raised to that of a temple. We use the word temple, for want of some better term. A house with offices necessarily suggests the idea of its being inhabited by ordinary mortals, who require fire and cookery; but a building, evidently a dwelling-house, and yet without visible offices, situated in garden scenery, suggests to us the idea of the inhabitants being something more than mortal, and living, perhaps, like our first parents, only to admire the beauties of the garden. But these are fanciful hints, which some only will be able to understand and apply properly. If we could once get rid of our prejudices in favour of existing fashions, and let our reason have free exercise, the planting out of offices, and concealing houses by trees so near as to touch them, would not be given up entirely, because that would be nothing more than to set up one fashion in order that it might put down another; but it would be given up as a general and indiscriminate rule.

*Norbiton Hall; R. H. Jenkinson, Esq., F.H.S., &c.* — This place has long been celebrated on account of the number of new pelargoniums, *Cistineæ*, cactuses, and other plants, which have been raised by Mr. Jenkinson, and figured in Sweet's *Geraniaceæ, Cistineæ, Flower-Garden*, and the other botanical



periodicals. The grounds are flat with little distant prospect; but they are rendered intensely interesting by the manner in which flowers and flowering shrubs are distributed on the lawn near the house, and along different walks. The most remarkable feature on the lawn, both near the house, and on one side of a terrace-walk, is the number of large single specimens of herbaceous plants rising from dug spots in the turf, not more than from 9 in. to 18 in. in diameter. Another striking feature is the prevalence of beds covered with what may be called floricultural rockwork. This kind of rockwork is not to be considered as an imitation of natural rockwork, but rather what a kitchen-gardener would call mulching the ground with rough stones, flints, or masses of partially vitrified bricks, with a view to retaining moisture, sheltering the plants from drying winds, and keeping each plant distinct; while at the same time a greater number can be displayed to advantage in a given space than on a flat surface. This assertion may not, at first sight, appear obvious, but a little consideration will satisfy any one of its truth. When plants grow on a flat surface, their stems spread themselves on every side horizontally along that surface; but when a plant is surrounded by stones so as to form a sort of basin round it, instead of extending itself horizontally, it is forced to rise on the sides of the stones, and presents a surface to the eye of the spectator as much greater than it could have done on the flat surface, on which the stones rest, as the hypotenuse line of a right-angled triangle is longer than the base line.

By covering all the surface of a dug mass or bed with angular blocks of stone, or conglomerations of vitrified clay, except the mere space required for the stems of the plants to rise through the ground, evaporation from the soil is almost completely prevented, and much less watering is consequently required; while, by the rough protruding parts of the stones or bricks sheltering the plants from high winds, and, in the case of very small plants, even shading them, they grow much faster in hot, dry, and windy weather. Where the stones are of a dark colour, like vitrified bricks, they powerfully absorb the heat of the sun during the day, and give it out at night; thus producing a much warmer climate than could otherwise be obtained, and one consequently better adapted for delicate green-house and hot-house plants turned out during summer. Stones of a black or brown colour, besides absorbing the heat, form a much better background to flowers than common garden soil, which generally becomes white, or bleached and dusty, in consequence of alternate watering and sunshine.

The distribution of vitrified bricks over the surface of a bed may be said to divide the surface of the bed into cells, each of which may be compared to a teacup, in the narrow bottom of which the plant is placed, and its shoots grow up, and spread over its sides; thus not only presenting, as already observed, a greater surface to the eye, than it could have done on a flat surface equal in extent to what would be covered by the cup, but presenting it, at least on one side of the cup, at a better angle to be seen, and even raising the shoots of the plant, and bringing them nearer the eye. It thus appears, that this kind of rockwork, or, more properly, stone-work, is as useful and economical with reference to culture, and the display of showy or rare plants, as it is effective as a picturesque ornament, contrasting, as such beds do strongly, with the softness and smoothness of the lawn on which they are placed.

To make the most of this principle in planting rare alpine, it is only necessary to have a number of pentagonal or square (the only two forms by which no space will be lost) flat pots or saucers of earthenware made, with spreading rims, say 1 ft. in diameter and without bottoms, or rather with very large holes in the bottoms. These being set down close to one another over a bed of prepared soil, a plant might be placed so as to come up in the centre of the bottom of each, which would spread up the sides of the pot, and thus produce a maximum of effect in a minimum of space.

There are some beds on the lawn at Norbiton Hall, and along the margins

of the walks, which are not covered with rockwork; but these for the most part are planted with plants of one kind, intended to spread over the entire surface, in order to display large masses of one kind of colour, such as that of *Petunia*, *Pelargonium*, &c. Others are planted with large single specimens of showy plants or low shrubs, allowing ample room for each to form a handsome bush, without touching any of the bushes or plants around it.

We never in any other garden saw such a profusion of admirably grown single plants on the lawn. The most conspicuous of these at this season was the peony, many varieties of which were magnificently in flower; and we observed that such as had gone out of flower had the flower-stalks cut off close to a leaf, so that the bush presented a handsome mass of foliage, of itself ornamental. Though the number of single herbaceous plants on the lawn is so great, yet they are grouped together in such a manner as at a distance to appear in masses, and to leave sufficient glades of turf to produce effect by contrast. These single plants are previously cultivated for two or more years, as may be necessary, in a reserve garden, till they become strong; and before they are placed on the lawn, an ample pit of proper soil is prepared for them. After the plant has been planted, all the surface of this mass of prepared soil is turfed over, except just as much as will contain the stems of the plant, surrounded with a ring of naked soil, two or three inches in width, and on a level with the surface of the turf, and to be kept stirred, and, as occasion requires, watered.

There is an excellent collection of roses here, and we never before saw such a fine display of all the different kinds of yellow rose. A part were standards budded on the wild rose in the open border, some were bushes there raised from suckers, and a number also raised from layers or suckers trained on a wall having a north-west exposure. These roses get no pruning, further than cutting off the flower-stems when they go out of bloom. We also saw here a very fine variety or hybrid of the China rose, which was trained against a wall along with the yellow roses, and had passed the severe winter before last without any injury. It is called *l'Art* incomparable, and is strongly recommended by Mr. Jenkinson, both for its fine dark colour and great hardiness.

There are many valuable gardening lessons to be learned at this place, besides the true use of floricultural rockwork, and the art of managing single specimens of herbaceous plants on lawns, and of grouping them with flower-beds. One of these lessons, and that not the least important, is the advantage of growing all herbaceous plants in beds or borders, and all shrubs or trees in shrubberies or plantations, so far apart as never to touch each other. We have often argued in favour of this practice, and even applied the term *gardenesque* to it; but here it has been done for many years, and the excellent effect of it is shown in the fine single specimens that present themselves in every part of the grounds. Though every part of the beds and borders is filled, yet in no part whatever is there the slightest appearance of crowding, or even of that equidistant placing of the single specimens or beds which becomes monotonous from want of that breadth which can only be produced by glades of turf.

In planting shrubberies, the practice of keeping the shrubs distinct, and always pruning or thinning out, so as to keep each near, but never touching those adjoining it, is particularly worthy of imitation; as well as another, that of not mixing rapid and large growing trees with slow-growing trees and shrubs. Indeed, as Mr. Jenkinson remarked to us, the reason why shrubs and low trees are not more cultivated in England is, that, instead of being planted by themselves, they are mixed with timber trees, and, when these begin to choke the low trees and shrubs, the latter are destroyed to make room for the former. In cases where the shrubbery plantation, after a certain number of years, is not thinned out so as to leave only the timber trees, the shrubs and low trees are so far overpowered by them, as to lose the greater part of their beauty; so that in either case their beauty

is lost to the proprietor and the country. This will be the case till some mode of planting is adopted, by which low trees shall be placed by themselves, or at least only along with large shrubs. The greater part of the species and varieties which may be procured in British nurseries remain, in the meantime, unknown to the possessors of our country seats, and nurserymen do not meet with that encouragement which they ought, for the trouble of having collected them together, and of propagating them for sale. We have much more to say respecting this place, and the exquisite taste and skill of its proprietor, which we reserve till we shall have had an opportunity of paying another visit.

The order and keeping of the lawn and flower-beds and borders were of the highest and most refined kind, which produces the more effect, when contrasted with a comparatively wild part of the shrubbery bordering a distant walk, in which furze and broom, and native plants, are springing up luxuriantly among single specimens of low trees, especially of *Crataegus*, *Pyrus*, *Viburnum*, and large-growing shrubs, with some of the more rare pines and firs, such as *Pinus Sabiniana*, *P. Coulteri*, *P. ponderosa*, *Abies Douglasi*, &c. Much may be done in this way where there is abundance of space, and the ground is naturally poor, and covered with heath and other plants which inhabit poor soils, at very little expense beyond that of first planting. In matters of this kind, Mr. Jenkinson's taste is most judicious, and it is much to be wished that gentlemen of large estates could be imbued with it. A hundred acres planted in this way would be a forest or arboretum of great beauty and interest. Let it only be considered that there are between 70 and 80 kinds of *Crataegus* alone that are adapted for such a purpose.

*Wimbledon House; Mrs. Marryatt.* — We never saw this place in so much beauty as it now appears, and particularly the flower-garden. Some overgrown beds of rhododendrons, azaleas, &c., which overpowered the effect of the small flower-beds, destroyed the harmony of the masses, and made the garden appear smaller than it really is, have been removed. The straight elm walk, which leads from the old green-house near the mansion to the flower-garden, used to be buttoned with Chinese flower-pots set on the turf; but these pots have now had tiles placed under them as plinths, and the effect is much more satisfactory, by giving stability and a greater appearance of adaptation. A basement to the plinths, of gravel, connected with the walk, or the plinth brought close to the edge of the walk, is still wanted to render the effect completely architectural. Having described this place in great detail in our *Suburban Gardener*, we shall only repeat here our expression of satisfaction at the high order and keeping in which we found every thing, greatly to the credit of Mr. Redding, the gardener and general manager, and of his excellent mistress.

*The Cottage of H. B. Ker, Esq., in Park Road, Regent's Park.* — In this dwelling the walls and ceiling of a dining-room have been lately painted in the Pompeian style by the celebrated artist Eastlake. The sides of the room are divided into two parts; the one is painted in vertical panels, which reach to within 2 ft. of the ceiling, and these 2 ft. form a sort of frieze, which is to be considered as representing an architectural landscape seen over the vertical panels which form the sides of the room. The vertical panels contain figures representing the chase and capture of the hares and birds supposed to be caught for dinner, and the preparation of the different fruits for the dessert. The landscape of the frieze consists of columns and other architectural forms, representing rather the foreground of the landscape than the landscape itself. No animals, figures, or forms, with one or two exceptions, are introduced, of which there is not a precedent in the figures collected from the ruins of Pompeii. The result of the whole is interesting, as carrying the mind back to the style of decorating rooms adopted by the most civilised people of the world 2000 years ago.

In our next, we shall have something to say on certain gardens in Staffordshire and Derbyshire, having just returned from a professional visit to the

latter county, and taken the opportunity of going as far as Sheffield, and visiting Chatsworth, Bretby Hall, Keddleston, Elvaston Castle, Drayton Manor, Manley Hall, the Sheffield Botanic Garden, that at Birmingham, &c.

---

ART. IV. *Caledonian Horticultural Society.*

THE Summer General Meeting of this Society was held on June 6., at their garden, Inverleith; and the exhibition of plants was the most splendid, and the promenade the most numerous and brilliant, ever known. The company who visited the garden in the course of the afternoon must have exceeded 2,500; and at one time there could not be fewer than 2000 present. Both the lawn and the flower tents have been enlarged since last year; but the directors will need still farther to extend them; for the lawn was over-crowded with company, and the fine exotics were too closely crowded on the stages of the tents.

The awards of prizes were as follows:—For fine shrubby exotics, nurserymen's prize, to Messrs. Dickson and Sons, Inverleith Nurseries; the plants being *Fabiàna imbricatà*, *Clématis tricolor*, *Borònia denticulatà*, *Státice arbòrea*, *Lantàna Sellòwii*, and *Cactus Jenkinsòni*. The practical gardener's prize, to Mr. George Stirling, gardener to Lord Melville, Melville Castle, the specimens consisting of *Pimelèa ròsea*, *P. hispida*, *E'pacrìs heteronèma*, *Borònia denticulatà*, *Èlichrysum spectabile*, and *Euphòrbia speciosa*. For fine herbaceous exotics, the nurserymen's prize was also voted to Messrs. Dickson of the Inverleith Nurseries, the plants being *Oncídium flexuosum*, *Sarracènia psittacina*, *Gesnèria scèptrum*, *Cattlèya Forbèsii*, *Stylídium fasciculatum*, and *Anagállis Philipsii*. The practical gardeners' prize, to Mr. David Brewster, gardener to Colonel Lindsay of Balcarres, who produced *Campánula gargànica*, *Cinerària (?) britànica*, *C. picta*, *Agapánthus umbellatus*, *Gazània regina*, and a new spotted *Calceolària*. For fuchsias, premiums were awarded to Mr. James Kelly, Inverleith; for *F. fùlgens* and *globòsa major*, and to Mr. David Brewster, Balcarres, for *F. Brewstèri* and *globòsa*. For Cape heaths, two premiums were also voted: the first, to Mr. George Stirling, Melville Castle, whose kinds were *Erica ventricòsa álba*, *perspícua*, and *muscaria*; and, next, to Mr. John Young, gardener to Sir James Gibson Craig, Riccarton, the species being *Erica cylindrica*, *tubiflòra*, *ventricòsa erècta*, and *grandiflòra*.

The display of pelargoniums or stage geraniums was extensive and beautiful; and three premiums were awarded; the first to Mr. James Kelly, Inverleith, who exhibited splendidissima, gem, Dennis's perfection, spéculum mún-di, belle Catharine, and cottager; the next to Mr. William Rintoul, gardener to James Balfour, Esq., of Whittingham, who exhibited Foster's Jewess, Rendle's alarm, climax, beauty of Ware, Geraldine, and nulli secundus; and the third to Mr. John Young, gardener to Thomas Oliver, Esq., Newington Lodge, who produced *Forstèri ròsea*, *Alicia*, gem, amábile spléndens, Dennis's perfection, and *Diomedè*. Several admirable specimens of *Tropæolum tricolorum* in flower, attracted much attention. One was trained pyramidally, in a natural and elegant manner, and for this a first premium was voted to Mr. Robert Foulis, gardener to Sir P. C. Durham, of Fordel. Another was fan-trained, and for it a premium was awarded to Mr. Peter Thomson, gardener to J. J. Hope Vere, Esq., of Craigiehall. For a third a premium was voted to Mr. James Mackintosh, gardener to Robert Ferguson, Esq., of Archerfield. The South American verbenas were also very showy, and handsomely spread out on small trellises. Two premiums were voted; first, to Mr. Kelly, Inverleith, whose kinds were, *Arraniàna*, *Tweediàna*, *incisa*, *Melindres*, *latifolia*, *Neillii*, and *teucroïdes*; and next to Mr. John Young, Newington Lodge, who produced *V. incisa*, *Tweediàna*, *latifolia*, *grandiflòra superba*, *Arraniàna*, *Tweediàna superba*, and *teucroïdes*. The cinerarias were likewise very brilliant, and partook of novelty. The silver medal was voted to Mr. Brewster, Balcarres, for a collection consisting of *C. superba*, *purpurea*, *bicolor*, and *Bain's seedling*; and a premium was awarded to Mr. Kelly for his collection, containing *bicolor*,

*Waterhousiana*, *élegans Newmanii*, and *spléndens*. Several very beautiful specimens of *Cactus* appeared on the stage, chiefly *speciosissima* and *Jenkinsonii*, and premiums were voted to Mr. Brewster, Balcarres, and to Mr. John Gow, Tulliallan. But there was no competition in tropical orchidaceous plants, the culture of those curious and lovely epiphytes, so abundant in the collections of Loddiges at Hackney, and Rollisson at Tooting, not being yet sufficiently general among private cultivators in Scotland.

Several very superb bouquets of cut flowers adorned the tents; and premiums were awarded for them to Mr. Rintoul, Whittingham; Mr. Brewster, Balcarres; and Mr. William Smith, MountLodge, Portobello.

The specimens of fruit were not numerous, but excellent of their kind. The silver medal was voted to Mr. Robert Watson, gardener to David Anderson, Esq., of Moredun, for beautiful peaches and nectarines, and white, black, and grisly Frontignan grapes; and premiums to Mr. William Cuthbertson, gardener to the Earl of Roseberry, Dalmeny Park, for well-ripened figs; and to Mr. Charles Kay, gardener to James Dundas, Esq., of Dundas Castle, for black Hamburg and white muscadine grapes.

Numerous fine plants were sent for exhibition only, and some of these formed, indeed, the chief ornaments of the show stage. A large orange tree, profusely covered with fruit, and several magnificent Cape heaths, were from the Royal Botanic Garden, which alone, indeed, could afford such noble specimens. Extensive collections of rare green-house plants, and the most showy geraniums, exceeding fifty in number, were from Messrs. Dickson and Company's Leith Walk Nurseries. Messrs. Eagle and Henderson also contributed some fine plants; as did likewise Messrs. T. and W. Handasyde of Fisherrow, and Mr. Niven of the Hillside Gardens. The private contributors of plants were Professor Dunbar, Rose Park, who sent an *Azàlea indica álba*, forming a large bush, and completely clothed with its pure white blossoms, so as to excite general admiration; Thomas Hay, Esq., Prospect Bank, who sent choice *pelargoniums*; and also Mr. Macnaughton, Edmondstone Garden; John Henderson, Esq., Trinity; and Dr. Neill, Canonmills, who contributed general collections of green-house and stove plants.

The whole grounds were in the highest state of keeping, evincing the excellent management of the garden superintendent, Mr. James M'Nab.—*P. N.*

---

#### ART. V. *Retrospective Criticism.*

*LOA'SA laterítia*.—At p. 139. vol. xiv. of the *Gardener's Magazine*, it is stated that *Loàsa laterítia* is an annual in its native country; and this year the Horticultural Society of London have distributed packets of the seeds of this plant, also describing it as an annual. With me it is decidedly perennial; as my old plant, which flowered and ripened abundance of seed last year, is now growing stronger in the green-house than autumn-sown plants in the stove. It will also be much earlier in flower, as is commonly the case, than the younger plants.

At the show at the Horticultural Gardens on the 11th of last July a specimen of this plant was exhibited, and received a prize as *Loàsa aurantiaca*. (See *Gardener's Magazine*, vol. xiv. p. 400.) I was sorry to observe this at the time, as I think the Society ought to adhere rigidly to the proper names of exhibited plants, in order, in some sort, to supply a standard for practical men to go by. This multiplication of names, now so common and so reprehensible, is a very serious evil to young gardeners, and also deters many, in all ranks of society, from the botanical study of plants, by the confusion it creates. The genus *Verbèna* is very much involved in this absurd practice; and the present season is adding another instance, if not more, to the already long catalogue.

—*A Young Subscriber.* May 16. 1839.

*Ceanóthus collinus*.—Erratum. In p. 231., the paragraph placed under

*Pomaderris prunifolia*, commencing "This plant was raised in the Handsworth Nursery, from seeds sent home by the unfortunate Douglas," &c., should have been placed under *Ceanothus collinus*.

---

ART. VI. *Queries and Answers.*

*PROFESSOR Henslow's Queries on Hybridising.* — Did you see the queries in the *Gardener's Gazette* of June 9., which were given by Professor Henslow to the Cambridge Horticultural Society, at a late meeting of that body? They refer to the interesting subject of hybridising plants. Though most of these queries are of a simple nature, the difficulty of attending to the minutiae necessary to a final and satisfactory answer is so great, that I fear the present generation will not be able to give a satisfactory answer to them. However, I may be in error; for you will recollect that in a former letter I gave you something like an answer to the second query, which I said was very extraordinary. The Hon. and Rev. W. Herbert made the discovery, and informed me of it; but, as it will soon appear in his own forthcoming work, you had better say nothing farther about it at present. — *D. B. Kingsbury, June, 1839.*

The following are the queries alluded to by our correspondent: —

"1. Does any peculiarity become more firmly fixed in plants, by being transmitted through several generations? Suppose B to be a peculiar variety (as a yellow flower) raised from a like variety A, would an equal number of the same variety as A and B be raised from the same number of seeds of A and B respectively?

"2. Is the pollen of a wild plant (or one in its uncultivated form) more effectual than that of some other cultivated variety, in fertilising the same species? Would the pollen of a wild cabbage stain the seeds of the neighbouring cauliflowers more readily than would the pollen of broccoli, red cabbage, &c.? Please to give any information about the degree of care necessary in raising seeds of the more artificial vegetables and flowers, to prevent their being accidentally crossed by other varieties. Will a *single* plant of one variety produce much injury in a *large* bed of another? Is there more difficulty in preventing the more artificial vegetables being crossed than the commoner ones, or those which retain more of their original form? Of course there would be a greater tendency in the former to degenerate; but this question only applies to the effects of accidental crossing from other varieties.

"3. If a variety of a plant be crossed with another variety, and likewise with the plant in its *aboriginal* state, will the effect on the character of the first seeds be *greater*, or will it be more permanent, in the *successive seedling* generations, *in the one case than in the other*?

"4. When the seeds of a highly cultivated plant, as of a *calceolaria*, produce great diversity, do you attribute part of this diversity to crosses from others, or to deterioration and to differences of external conditions? Do the seedling varieties in such cases, though *not* producing plants like their parents, somewhat resemble each other?

"5. Do you know any cases of a peculiarity in a plant, which, although it was not transmitted to the immediate offspring, yet reappeared in the second generation (grandchildren), and where it is believed not to have been caused by a repetition of the conditions that first produced it in the original plant?

"6. In making hybrids, do the seedlings mostly resemble the father or mother?

"7. Do you know any cases of different kinds of peas, when sown near each other, having produced crosses by accident?

"8. In making hybrids: in those cases in which the *stigma* of one plant has been impregnated by the *pollen* of a second, and afterwards the *stigma* of the second by the *pollen* of the first, what were the differences of the seedlings with respect to their resemblance to their parents?"

---

THE  
GARDENER'S MAGAZINE,  
AUGUST, 1839.

---

ORIGINAL COMMUNICATIONS.

ART. I. *Recollections of a Tour chiefly between London and Sheffield, made during the last three Weeks of May, 1839.* By the  
CONDUCTOR.

THOUGH notices of more than one of our tours have been left unfinished, yet, before we resume them, we shall devote a few pages to some recollections of what we saw during a late excursion. Having been called professionally into Derbyshire, we went to Birmingham by the railway, and thence to Derby and Sheffield. At the latter town we saw the botanic garden and the general cemetery, and in its neighbourhood Chatsworth; and near Derby we saw the different residences of the Messrs. Strutt, and also Bretby Hall, Keddestone Hall, Elvaston Castle, &c. Near Lichfield, on our return, we saw Manly Hall, Aldershaw, and several other places; and at Birmingham the botanic garden, Handsworth nursery, cemetery, town hall, new school, new market, &c. Having passed through the same tract of country, and seen nearly all the same places in 1806, and more than once between that period and our northern tour of 1831 (see our Vol. VII. p. 385. 513. 644.), it may be useful to give a slight general glance at the comparative differences which we observed in the general face of the country, and in the appearance of the towns.

Trees are the objects which have most effect in improving the natural features of a country, and therefore we begin with them. Many belts of plantation, particularly in Derbyshire, which were newly planted, or made but very little appearance, in 1806, are now from 50 ft. to 70 ft. in height, and have completely changed the face of the country. The black Italian poplar (*Populus monilifera*) in 1806 was little known, but was strongly recommended by the Messrs. Pontey of Huddersfield, and planted very generally throughout the north of England. In 1826, these poplars began to take the lead of all the other trees in plantations made during the first ten years of the present century (see our Tour made in October, 1826, given in Vol. V. p. 671.); while at present (1839) they are conspicuous in every part of the country, and have completely overtopped the old oaks, and in many cases even the elms. In a picturesque point of view, these poplars, as they appear at present, are injurious, because they have changed the customary scale by which the eye estimates the magnitude of objects in scenery; and they have also given a general sameness of appearance to immense tracts of country, which were formerly more or less distinguished by their terrestrial features, in conjunction with the slower-growing hedgerow trees. In 1806, the only poplars that were to be seen of any size were, the white poplar, and the common black poplar, with occasionally a Lombardy poplar, rearing its cypress-like head in some gentlemen's pleasure-grounds; but now these and all other poplars are lost amid the multiplicity of the trees of the black Italian kind. In many places these trees are from 80 ft. to 100 ft. in height, with trunks 18 in. in diameter. Between Chesterfield and Sheffield there are many along the roadside of all sizes; and near Shenstone, in the vicinity of Lichfield, some Lombardy poplars have been planted apparently accidentally, along with the black Italian poplar, in a hedgerow, which thus afford a

striking proof of the comparatively rapid growth in height and bulk of the latter species. Between Shenstone and Walsall there is a plantation of one or two acres on the estate of Sir Robert Lawley, which has made extraordinary progress. It is on good, deep, loamy soil, rather moist; and we were informed by an intelligent countryman in the neighbourhood, that though only fourteen years planted, the trees, if cut down and sold, would purchase the land. The great objection to these trees is the sameness which they produce in the appearance of the landscape; but this sameness is greatly owing to all the trees being apparently of similar forms, ages, and sizes; conditions that will be changed as soon as a part of the trees become fully grown, and are partially cut down as timber. Besides, supposing the trees to be fully grown, and not to be cut down, but to remain till they have the same appearance of age as the oaks and elms, their heads having become comparatively round, instead of pointed, as they are at present, would harmonise with these slow-growing round-headed trees, in the same manner as they do at present with the old thorns and hollies which are left standing in parks. But even if they did not harmonise in a picturesque point of view, still, if they were useful as producing a great bulk of timber in a short time, and also a great deal of shelter and shade (both which effects are useful in grazing countries), why should they be objected to merely because they do not satisfy the eye that looks at them with reference only to one particular kind of beauty or effect? Artists, from the time of Gilpin, have, in our opinion, been far too exclusive in their mode of viewing nature; and, by confining their admiration to the picturesque or sculptural, or, in other words, to what is peculiarly suitable for their art, they have lost sight of the beauties of high polish, neatness, cultivation, agriculture, architecture, arboriculture, and other kinds far more important to society, and affording much greater evidence of civilisation, comfort, and the general diffusion of human happiness, than mere picturesque beauty. We allow that a taste for picturesque beauty is an evidence of refinement, or of cultivated taste; but we contend that it is only one beauty out of many that ought to be sought for in a civilised country, by minds of general cultivation. The enthusiast in favour of the picturesque, however, can see no other beauty, and hates straight roads, hedges, and walls, and every appearance of order, regularity, symmetry, and neatness. This feeling has been strengthened and perpetuated by the eloquent writings of such authors as Gilpin and Price, though unintentionally; because the true way of judging of the writings of these great men is, to consider them as endeavouring to oppose the formality and sameness of the taste which prevailed in their times; in Gilpin's time, of the old avenue and terrace style, and in the time of Price, of the clump and belt style. The writings of every author, indeed, to be truly judged, ought to be taken in connexion with the times in which he lived.

This exclusiveness of taste on the part of educated persons is not more justifiable than the exclusiveness of taste of those who are comparatively ignorant of the fine arts; such, for example, as that of common farmers and country labourers, who can see no beauty in fields that are not laid out in ridges and well cultivated, in hedges that are not straight and neatly clipped, or in trees that have not clean and straight stems and strictly symmetrical heads. Farther, with reference to the black Italian poplars, is not some general change in the face of the country preferable to having it for ever the same in appearance? It is an undeniable fact, that the black Italian poplar will produce a greater bulk of timber in a given time on ordinary soils, than any other tree at present cultivated in this country. So long as there is a demand for timber, therefore, let us plant this tree, and let its utility compensate for its want of beauty; but if any one would rather be without utility for the sake of beauty, to this doctrine we have no objection; on the contrary, we are glad that there are such persons, because our leading principle is, that taste should be free, and it is only by this being the case, that we can see displayed that interesting variety of objects and scenery, which is to be found in this country, more frequently, perhaps, than in any other.



*Farming.*— On the surface of the farm lands, throughout the tract in question, with the exception of those parts where commons have been enclosed, there is, perhaps, no great change recognisable at a distance. The surfaces of moist meadows are still, at this season, yellow with the blossoms of the crow-foot, an indication that they are not sufficiently drained; and the dry gravelly surface of grass lands about Lichfield and Shenstone are, at this season, white with the downy seeds of the dandelion, a proof that they have not been sufficiently manured, or clayed, or sown down with such grasses and clovers as will form a thick matting on the surface, and subdue, and ultimately starve out, the dandelion. As to agricultural practices from London to Derby, the clumsiest forms of ploughs may still be seen, drawn with from three to five horses in a line, at a snail's pace; and on gravelly soils, preparing for turnips, more especially in the neighbourhood of Shenstone, the heaps of couchgrass ready to be burned, are as thick as the heaps of dung ready to be spread abroad should be. In short, we saw such very bad farming in the neighbourhood of Lichfield and Shenstone, that it is difficult to conceive how the farmers can pay any rent worth mentioning, and live comfortably. In the whole course of our tour we did not see a single Finlayson's harrow, an implement calculated to work wonders on any soil, but more especially on such as have never been ploughed to a proper depth, or are filled with couchgrass. On all such soils, it is an admirable substitute for the harrow, the plough, and the subsoil plough.

*The Towns,* it is almost unnecessary to say, have been wonderfully improved since 1806, and the progress of Birmingham, even since 1831, when we last saw it, is astonishing. The public buildings have been appropriately noticed by Mr. Humphreys, Mr. Godwin, and others, in the concluding volume of the *Architectural Magazine*, and therefore we shall confine ourselves to noticing the great increase in the number of the villas, in that part of the neighbourhood of Birmingham which surrounds the botanic garden. There is a great improvement in their exterior architecture, and more choice plants are conspicuous in their gardens. The botanic garden has already had a considerable effect in improving the general taste of the Birmingham people for plants. Very little change has taken place in Lichfield, as it is neither a place of commerce nor of manufacture; but the little town of Walsall exhibits some very handsome small villas and street houses, erected within the last seven years, which are not surpassed by any suburban villas in the neighbourhood of London. Dudley has had the approach from Birmingham widened; but we were sorry to hear, when in this town, that the lime-works are being extended under the old castle in such a manner, that the fall of that venerable and picturesque group of ruins is anticipated by the townspeople. The park at Himley is undergoing the same subterranean operations, and the noble mansion there, it is said, will, in all probability, be pulled down in consequence. Derby has improved rapidly. There are now building, an athenæum, post-office, banking-house, and hotel, which will form a splendid continuous elevation. There is also a handsome Catholic church erecting from a design from Mr. Pugin, side by side with an ancient Protestant church; which is as it ought to be in a liberal and enlightened country, where thought is free as well as taste. In the neighbourhood of Sheffield many villas have been erected since we last saw that town in 1826; and the botanic garden and general cemetery are very great public ornaments. In this town and Derby, the exhibitions of the mechanics' institutions display a great many interesting objects, highly creditable to all concerned. But what, perhaps, was more gratifying than anything else that we saw during the whole of our tour, was the marked improvement that we observed in the construction of the roadside cottages, wherever any had been recently built; and the greater display of fine flowers in the front gardens, both of new and old cottages. There is hardly one of these gardens that does not contain some of the fine plants sent home by Douglas and Drummond, or plants of Mexico and South America.

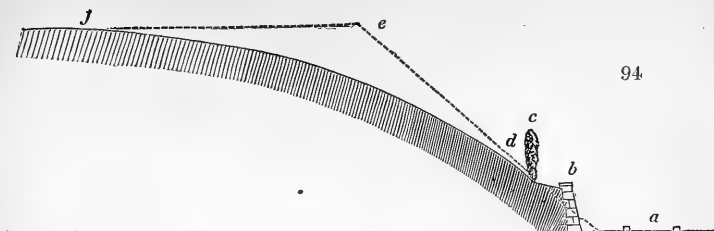
*Railroads.*— We say nothing of the railroads going forward everywhere, or

the magnificent bridges by which they cross, or are crossed by, the turnpike roads, because that would lead us out of our province. We cannot, however, help expressing our admiration at the science exhibited in these works, and especially in the bridges of the London and Birmingham railway, even as seen during a rapid transit beneath them. The stupendous cuttings in some places, the high embankments in others, the lofty bridges crossing the road every now and then, the tunnels in which all is darkness, and the beautiful and extensive views from the embankments and viaducts, render this road, which hypothetically might be considered dull and monotonous, actually full of variety. We recommend the reader to consult an admirable article on the subjects treated of in this part of our tour in the *Architectural Magazine*, vol. v., entitled "Fragments connected with Architecture and the Arts, from a Provincial Tour. By H. N. Humphreys, Esq."

Observing different modes of treating the ground on the margins of deep cuttings and high embankments, and plantations of mixed trees introduced in some places, and willows in others, we amused ourselves, while on the railway, in considering how the good earth buried in the immense embankments could be turned to account; and we can think of no way likely to be more effective than planting the sides with oaks, to be cut down periodically as coppice; or planting them with black Italian poplars, or Huntingdon willows, to be cut down when they grow so large as to prevent sufficient evaporation from the road. Where the direction of the railway is south and north, trees might be allowed to grow on each side to any height; but where it is east and west, the trees on the south side might require to be thinned occasionally, for the sake of admitting light and air. There is not, however, the same objection to shading a railway with trees that there is to shading a common road; because, whether the surface of the railroad is dry or moist can make no difference to the speed of the carriages or the comfort of the passengers; nor could the sinking of the embankments be increased by the shade, because no more rain will fall on it than if it were open. With regard to the sloping faces which form the sides of the deep cuttings, we know not what the ultimate intention of the railway proprietors is; but, as far as we have been able to form an opinion respecting these steep banks, it is, that, after enclosing 2 or 3 feet on each side of the railway, the remainder of the surface should be reduced to such a slope as would render it fit for agricultural purposes, and let to the occupiers of the adjoining lands, or sold to the proprietors. We cannot conceive how retaining these slopes in the possession of the railway company can afford them any annual profit worth mentioning, either under the spade or plough, grass or coppice; but, if subjected to a rotation, or even kept under perpetual pasture, a farmer would be able to afford the same average rent for them which he paid for the rest of his farm. To reduce the slopes so as to render their under surface fit for agricultural purposes, would not be so expensive a work as may at first sight appear. Supposing the surface to form an angle of  $45^\circ$ , which is as steep a slope as can be ventured on, where the surface is intended to be covered with earthy material, not solid rock; then by raising a perpendicular wall or facing of masonry, within 3 ft. of the road, on each side, the ground may be filled up behind it, and a hedge planted 3 or 4 feet further back, the base of which should be 1 or 2 feet higher than the top of the wall, and then the bank may be lowered, taking care to preserve the surface soil of the portion which is to be thrown into the adjacent field, and distribute it equally.

In the section *fig. 94.*, *a* is the railway; *b*, the parapet wall; *c*, the hedge; *d e*, the slope at an angle of  $45^\circ$ ; and *d f*, the slope at a cultivatable angle.

Surfaces, partly of rock and partly of soil, that would stand at an angle greater than  $45^\circ$ , might be planted with oak and birch; and strata of solid rock might have the sides nearly perpendicular. By proceeding in this way, all the spare ground that was not absolutely wanted for the track of the railway would be turned to good account, instead of being unproductive, or covered with weeds, as it is at present.



94

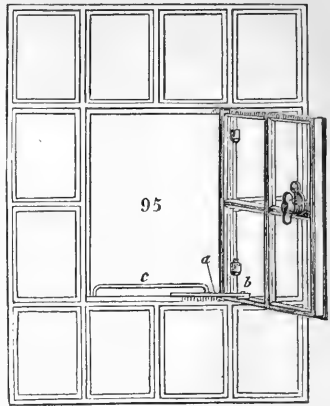
*Gratuities to Servants at Show Houses.* — Among other changes which have taken place since 1806, we may notice the difference in the gratuities given to servants for showing great houses. At that time, few persons, after being shown through such houses as Chatsworth, Bretby Hall, Wentworth House, &c., thought of giving less than gold; but now 5*s.*, and even 2*s.* 6*d.*, are received with thanks. We wish a similar reform could be made in the gratuities given to coachmen, guards, the drivers of post-chaises, and waiters. With respect to show houses, we sometimes think it would be an improvement, for every proprietor who had a show house to have a fixed sum per head for showing it on certain days, say to travellers; and to show it on certain other days, which may be supposed to be those in which the poorer persons of the neighbourhood will come, for nothing. However, it is much better that the houses of men of wealth and taste should be shown, even for a considerable sum, than not shown at all; because such exhibitions cannot fail to have some influence in improving the taste of the spectators, and showing the wealthy tradesman or manufacturer what he may aspire to.

*Public Gardens, and Mechanics' Exhibitions.* — Among the best modes that we know of for improving the taste of the inhabitants of country towns and their neighbourhood are, the establishment of public gardens, such as those of Birmingham and Sheffield; and the opening of exhibitions, such as those of the mechanics' institutes in these towns, to which gentlemen in the neighbourhood are kind enough to send pictures, sculpture, and other articles of beauty, curiosity, or of scientific interest. These exhibitions, to which all are admitted on the payment of 6*d.*; or every day, as long as they are open, for 2*s.* 6*d.*; cannot fail to have an excellent effect. We learn, on good authority, that, at the end of a fortnight after the Derby exhibition was opened, more than 20,000 persons had been to see it.

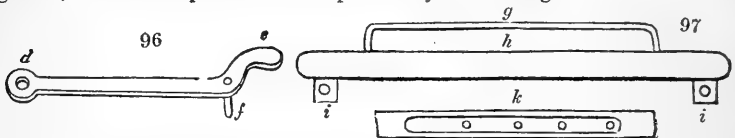
*Milford and Belper,* a few miles from Derby, are two of the scenes of the extensive manufacturing operations of the Messrs. Strutt; and here we saw some contrivances, which we think, if more known, would be extensively used. Among these, the most important is, the system of warming and ventilating invented by the late Mr. William Strutt, and first used in these works, and described in Sylvester's *Philosophy of Domestic Economy*, 4to, Lond. 1821, and now in general use throughout Britain for large buildings; but there are various others, some of which we shall attempt to describe.

*Cottage Window Staybar.* One of the most universally useful of these is a window fastening, or staybar, as it is technically called, for cottage windows, or the windows of manufactories, or, indeed, buildings of any kind where the windows are fixed, and do not slide in grooves, or are not suspended by lines and weights. This contrivance has the great merit of being perfectly simple, very economical in its first cost, and not liable to go out of order. The same principle is applicable to the opening and shutting of doors and gates of almost every kind, as well as to windows. To give an idea of the value of this contrivance, it is necessary to observe that, in the latticed windows of cottages, there is very frequently either one entire frame, or a portion in the centre of one, which opens, and is kept open, by an iron staybar, with an eye at one end which moves on a staple attached to the fixed part of the sash, and a hook at the other which drops into an eye in the part of the sash which is to be opened. Now, the objection to this hooked fastener is, that as there is

only one eye for the hook to drop into, the window can only be opened to the same width, whether the ventilation required be little or much; and, when the staybar is not in use, it hangs down, and is blown about, and very frequently breaks the glass. The new staybar, on the other hand, opens the window or door to which it may be applied to various widths at pleasure, from an inch to the whole width of the window or door, and the staybar can never hang down, or run the slightest risk of breaking glass. The general appearance of the new staybar, supposing the window to be open to its full extent, is shown in *fig. 95*, in which *a* is the staybar, which turns on the pivot *b* at one end, and slides along a horizontal groove under the guide bar *c* at the other.

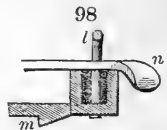


*Fig. 96* is a view of the staybar apart from the window, showing the eye *d*, the handle *e*, and the stud *f*, which drops into holes in the horizontal groove, so as to keep the window open at any desired angle.

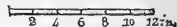
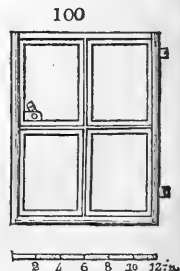
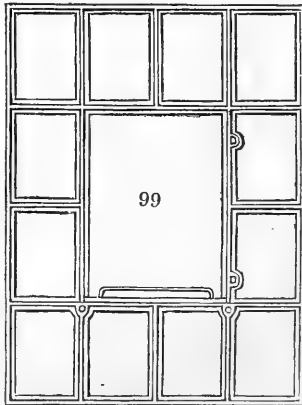


*Fig. 97* is a view of the groove and the guide-bar. *g* is the guide-bar or small rod which is for the purpose of keeping the staybar in its place in the groove *h*; *ii* are two plates with holes, by which the groove and guide-bar are riveted to the window; *k*, vertical profile of the groove, the guide-bar being removed, so as to show the holes into which the stud of the staybar drops. The groove is of cast iron, and the guiding rod is of wrought iron let into it and riveted, and both are bolted to the bar of the window by means of the plates *ii*, which are of cast iron.

*Fig. 98* is a section across the groove, the guiding rod (*l*) and the bar of the window (*m*), to which the groove is bolted; *n* is the handle of the guide-bar.



The window is cast in two pieces; the larger (*fig. 99*.) being 2 ft. 10 in. high, by 2 ft. 1 in. broad, and the smaller (*fig. 100*.) being 1 ft. 4 in. high, by 1 ft. broad, exclusive of the lead along the bottom and sides, which forms the rebate, and covers the joint. In casting the smaller window, it is essentially necessary that it be somewhat less in dimensions than the space into which it is to shut, in order that it may always move freely. The air is kept out from the



room within, not by the tight fitting of the sides of the small window to the sides of the frame, but by the contact of the edges of the sides of the small window with the beads forming the rebates attached to the inside of the frame; and also by means of the contact of the beads, or rebates, of the small window with the edge of the sides of the large one, or frame into which it shuts. In consequence of the sides never touching, the window moves with the greatest ease, whether expanded by heat in summer, or contracted by cold in winter, and weather-painted and smooth, or unpainted and rusty.

Fig. 101. is a horizontal section across the small window, and the two side bars, showing the outside beads at *g g*, and the inside beads at *h h*.

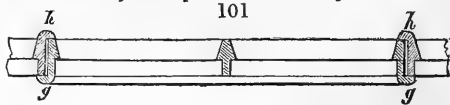


Fig. 102. is a vertical section through the small window and the top and bottom bars of the fixed frame, showing a weather fillet, or weather table, which projects half an inch from the general face of the window at *h*, and the staybar in the situation in which it rests when the window is shut, and also the groove and guiding rod at *i*.



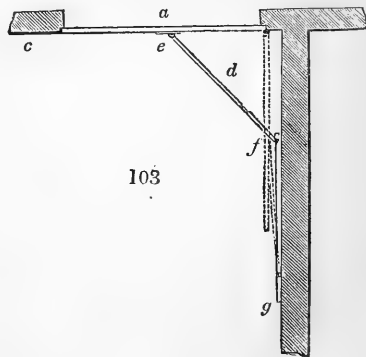
The total weight of this window before being glazed is about  $61\frac{1}{4}$  lb., and the prime cost in Derby is  $12s. 4\frac{1}{2}d.$  thus: —

	<i>s.</i>	<i>d.</i>
2 castings, 60 lb. at $1\frac{1}{2}d.$	-	7 6
Ironwork, $1\frac{1}{4}$ lb. at $1s. 1d.$	-	1 4 $\frac{1}{2}$
Fitting up, 6 hours at $24s.$ per week	-	2 0
Scurfing castings, 4 hours at $12s.$ per week	-	1 0
Priming window	-	0 3
Paint	-	0 3
	<u>12</u>	<u>4<math>\frac{1}{2}</math></u>
	Prime Cost	

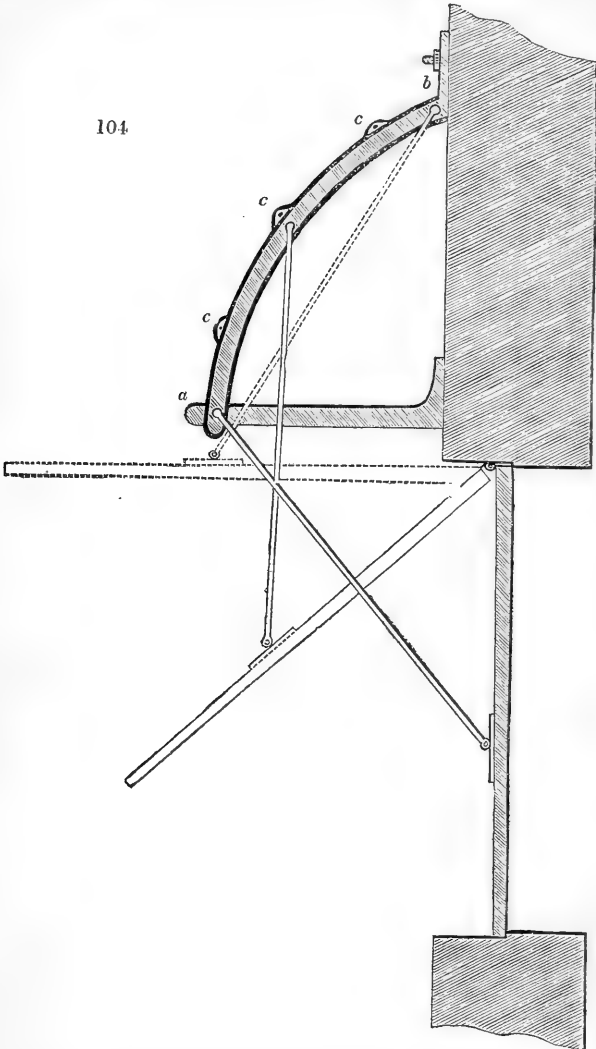
We consider this by far the cheapest and best cottage window that has been hitherto invented; it has been used in a great variety of buildings for 10 years, and when it is known, it can hardly fail to come into general use in cottage dwellings and manufactories. In London it may be obtained of Messrs. Cottam and Hallen, Winsley Street, Oxford Street, for  $13s. 6d.$  for a single window, or where there are more than half a dozen, for  $12s. 6d.$  each; at Messrs. Cubitt's, Gray's Inn Road; and at Mr. Roe's in the Strand, manufacturer of zinc and of tinned iron.

*Door Staybar.* — To understand how this staybar may be applied to opening doors fully, or as in the case of hot-house doors, to any degree of width, and to retain them fast at whatever angle it may be desirable to set them open, or to keep them fast when shut, it is only necessary to suppose the groove fixed to the wall horizontally behind the door.

Fig. 103. represents a horizontal section through a door (*a*), the wall of the hanging style to which it is hinged (*b*), and the wall against which it shuts (*c*). The door is supposed to be shut, and it is held in its place by the staybar *d*, which moves on a stud at *e*, and along a groove from *f* to *g*. All the rest requires no explanation to any one who has understood the description of the window.

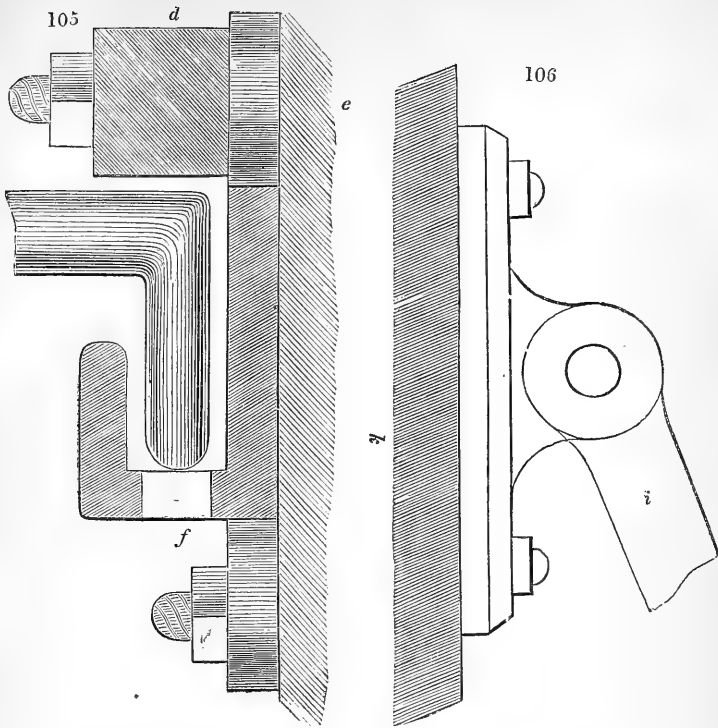


*Fig. 104.* shows a staybar for a door or a gate, in which the wall is on the same plane with the door. In this adaptation of the staybar, the groove in which it slides is made curvilinear, merely to facilitate the operation of sliding, because it would slide if the groove were straight. The curve *a b*, therefore,

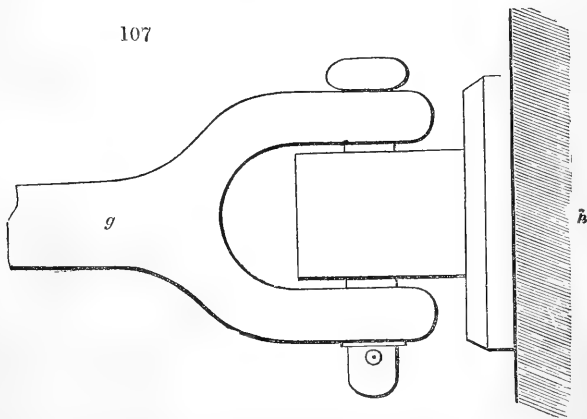


may have any radius that may be convenient, provided that it commences at *b* and terminates at *a*. The points *c c c* represent projections from the groove, having holes for screwing on a wooden guide-bar, to prevent the staybar from rising out of the groove.

*Fig. 105.* is a section of the groove of half the proper size, in which *d* is the guide-bar of wood screwed on to the groove at *e*; *f* is the opening in the bottom of the groove into which the staybar drops. These openings may



either be made at each end of the groove only, for the purpose of opening the door to the full width, or they may be made also at the intermediate points



*c c*, so as to open the door to different angles, which may be convenient in hot-houses for ventilation.

*Fig. 106.* shows a vertical profile of *fig. 107.*, *i* being the guide-bar, and *h* the door.

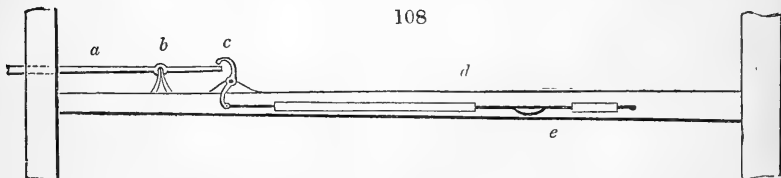
*Fig. 107.*, of half the proper size, shows the manner in which the guide-bar *g* is attached to the door *h*, the fitting not being tight.

It is to be observed that both the straight and curved grooves require a sort of cover or guide-bar all the length of the groove, placed so as to allow the hook of the stay or propping bar to be lifted out of the hole, but not out of the groove. In the straight groove (*fig. 103. e f*), a piece of wood  $1\frac{1}{2}$  by  $2\frac{1}{2}$  in. does very well for the cover; but in the curved groove a wrought or cast iron cover has been used, and the little tubes or projections marked *c c* in *fig. 104.* are cast on the groove to fasten the wooden covers to securely.

Gates and doors for back sheds, and for various departments connected with the kitchen-garden and offices of an establishment, may be most advantageously formed with staybars, instead of locks, bolts, or hooked or other fastenings. In rural architecture, the use of these staybars is calculated to be still more extensively useful than in gardening.

*Lodge Gate Fastening.* — In this contrivance the lodge gates, when in one piece, or single, as the technical term is, are commonly hung at the side farthest from the lodge, with a view, it may be supposed, of bringing the latch as near the person who comes out from the lodge to open the gate as possible. But it must be recollected, that after the latch is lifted, the operator (who is frequently an old person) must walk across the road, perhaps in the night when it is dark, or during rain or snow, and he or she (for this operation is generally performed by the female occupant of the lodge) must wait on the opposite side "gate in hand," till the carriage has passed through. Sometimes, also, when the horses are impatient in the daytime, or when it is dark at night, the gate opener, while crossing the road before the horses' heads, is liable to be knocked down by them, or by the pole of the carriage. These and other inconveniences attending this mode of opening gates are avoided by hanging the gate on the side *next the lodge*, and by having a long horizontal rod, reaching from the latch to about the middle of the gate. The gate opener advances only half across the road, pulls the rod to raise the latch, and walks a few steps backwards, opening the gate to its full width, and is at the same time protected by it. The application of the rod, by which the gate is to be opened, depends on the kind of fastening used. One of the simplest is, where the latch is retained in its place by a spring; and, the rod being used to pull it back so as to open the gate, when the gate is again shut the latch returns to its place of itself. The rod may either be conducted along the top, or the side of the upper bar of the gate, or under, or along one side of a bar from three to four feet from the ground.

*Fig. 108.* shows the mode adopted at Bridge Hill and Allestree, in which *a* is the latch supported on a fulcrum at *b*, operated on by the S lever *c*, by means

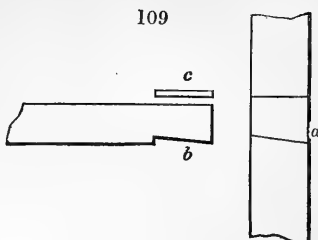


of the rod *d*, and the handle *e*. This handle serves both for pulling the rod backwards toward the hinges, so as to raise the latch, and for pulling the gate towards the operator, so as to open it by his walking a few steps backwards.

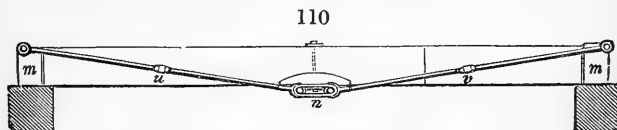
*Cast-Iron Heads or Hanging Styles to Gates, and Wrought-Iron Rods as diagonal Braces*, are common in field and other gates in this neighbourhood. The cast-iron hanging styles have mortise holes for the ends of the wooden bars, and these are made fast in a very simple but effective mode, which consists in having



the mortise wider at one end than the other, as indicated in *fig. 109.*; in which *a* is a section of the mortise, *b* the end of the bar which is fitted into it, and *c* a wedge, which, by keeping the tenon of the bar in its place, effectually prevents it from being drawn out. The hinges of such a gate are much less costly than the common ones, and the gate bars are preserved their full strength at the tenons. Two wrought-iron rods pass from the bottom of the falling style through the top of the hanging style, where they are made fast by nuts on their screwed ends, by which nuts they can be drawn up as tight as may be desired. The wrought-iron rods at the lower end are passed through a thin wrought-iron plate, which forms a sort of shoe to the falling style.



*Trussing Girders and Rafters by tightly screwing up Iron Rods* is a mode frequently practised in the floors and roofs of the works at Milford and Belper, and even in the rafters of hot-houses. Something of this kind has been effected by Mr. Mallet of Dublin, for securing certain decayed flooring and partitions, as described in the *Architectural Magazine*, vol. ii. p. 170. The two modes are exactly the same in principle, and will be easily understood by *fig. 110.*, taken from Mr. Mallet's article. Messrs. Strutt, to increase the



power of the rods, lengthen the studs on which they act, and in all cases the iron rods pass through cast-iron plates, shoes, or sockets, into which the ends of the girder, rafter, or joist, are inserted. This mode of raising or supporting sinking floors or roofs may frequently be of use to gardeners, when their hot-houses or sheds are in a state of decay.

*An Iron Nosing for the Steps of Stairs*, or to serve as a kerb for foot pavement in streets, is the next article that occurs to us. The object is to change steps of wood or brick into steps of greater durability than if they were of stone or iron, and at a small expense. For this purpose a nosing, or rebated piece of iron, is made fast to the step of wood by iron studs, or by being let into the walls at the ends of the steps, and this retains in their place flat tiles of terro-metallic earth, which are much longer before they wear out than any description of stone; which produce a step much lighter than if the whole were of stone or iron; and which can be renewed at pleasure. Such steps are well adapted for granaries and other agricultural buildings, and, in some cases, for the stairs of offices to mansions and cottages. The most economical application of this contrivance is, of course, in cases where the steps are made of wood.

*Brick Walls*,  $7\frac{1}{2}$  in. thick, and fair or smooth on both sides, are frequently used at Belper, not only for partitions, but even for the outside walls of cottages and other buildings, and for garden walls. A common 9-inch wall, as every reader of any experience in building knows, can only be built fair on one side; but  $7\frac{1}{2}$ -inch walls, having no bricks which pass right through the wall, the attention of the bricklayer is only required to one side at a time. These  $7\frac{1}{2}$ -inch walls are formed of bricks of the common size, and of bricks of the same length and thickness, but of only half the width of the common bricks, by which means they can be "worked fair" on both sides. These are laid

side by side, as in *fig. 111.*; in which *a* represents the first course, and *b* the second course. The bond, or tying together of both sides of the wall, is not obtained by laying bricks across (technically, headers), but by the full-breadth bricks covering half the breadth of the broad bricks, when laid over the narrow ones, as shown in the dissected horizontal section *fig. 111.* at *b*, and in the vertical section *fig. 112.* Besides the advantage of being built fair on both sides, *there being no headers, or through and through bricks* in these walls, when they are used as outside walls the rain is never conducted through the wall, and the inside of the wall is consequently drier than the inside of a wall 9 in. in thickness. These walls are adapted for a variety of purposes in house-building and gardening, in the latter art more especially. The only drawback that we know against them is, that the narrow or half-breadth bricks must be made on purpose.

*Arnott's Stove* we saw here undergoing what appears a considerable improvement; viz. fixing to its sides vertical cast-iron plates, 6 in. deep, and about 4 in. apart, for the purpose of increasing the surface, and consequently conducting away the heat more rapidly. An idea may be formed of this improvement, by the vertical profile of a portion of the top of a stove, *fig. 113.* The improvement is applicable to iron stoves of every description; and, of course, also to iron pipes heated to a high temperature, with steam or hot water, in hot-houses, or even to the bottom and sides of boilers.

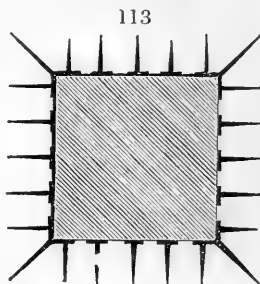
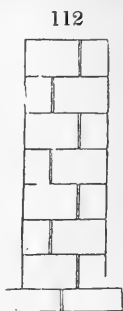
*Cast-Iron Heads to Rammers* are also used in this neighbourhood, instead of wooden ones; and they are adopted by the engineers on the railways and new roads now going forward in the neighbourhood of Derby, though we observe wooden ones still employed on the Birmingham line. The cast-iron heads are made rather smaller than the wooden ones in common use, and of different degrees of weight, from 8 lb. the smallest size, to 17 lb. the largest.

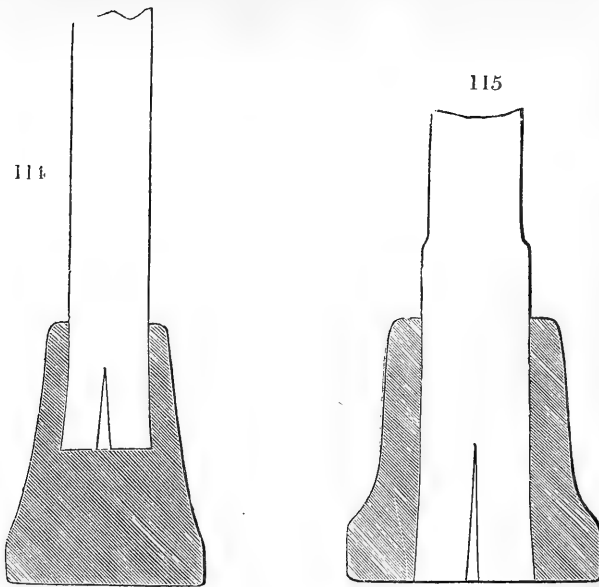
*Fig. 114.* shows the form of the head of a rammer of the smallest size, into which the handle is fastened by first splitting the end of the handle or shaft and entering a small wedge in it, and afterwards inserting it in the socket of the cast-iron head, and driving it home till it assumes the appearance shown in the figure. In this section, the lower part of the socket is made somewhat larger in diameter than the upper part, which makes room for the expansion of the shaft at its lower extremity, occasioned by driving it home.

*Fig. 115.* is a section of the head and lower part of the shaft of a rammer of the largest size; in which the socket for the shaft passes right through the head, and is made fast there by driving in a wedge in the same manner as in fastening the helve of an axe or a pick to the head.

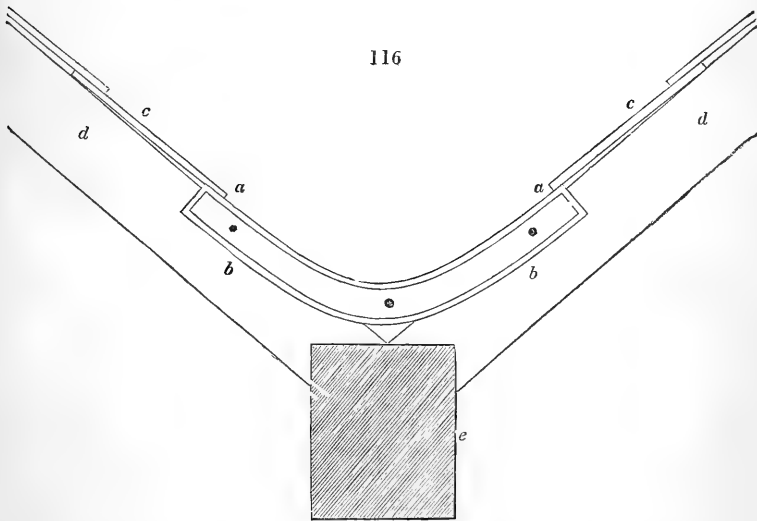
The advantage of these cast-iron rammers is considerable. In operating with a wooden rammer, the workman, if lazy, lifts it up only a few inches; and his letting it fall at that height has no effect on the ground whatever; but, if the head is of cast iron, if he lifts it up at all, its coming down, if only a few inches, will not fail to make an impression. It is wonderful, indeed, that this improvement was not thought of before. Mr. Paxton has adopted these cast-iron rammers at Chatsworth, and he finds them excellent.

*Cast-Iron Gutters to Roofs*, as a substitute for leaden ones, are found economical and effective. *Fig. 116.* is a section of a gutter between two roofs, in which *a a* is the gutter, with a flange (*b b*) for joining the different pieces

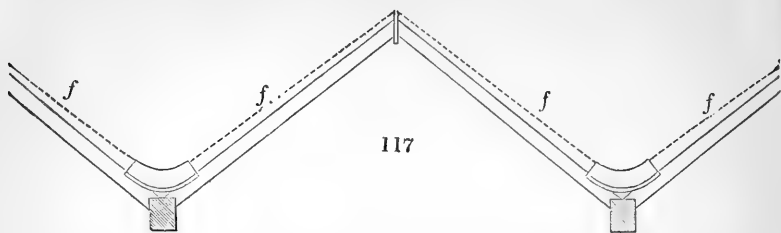




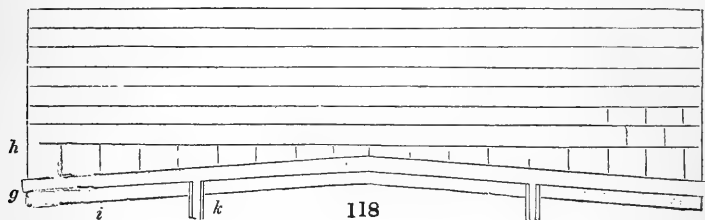
together; *c c* are the slates; *d d*, the rafters; and *e* the gutter beam. The fall found requisite to carry off the water is found to be from a half to three



quarters of an inch in the yard, and this necessarily occasions the plane of the roof to rise towards the centre of the building, as shown in the section *fig. 117.*, in which the rise is indicated by the dotted lines *f f f f*. All the care that this requires in slating or tiling is, to bring the upper edge of the



lower course of tiles to a level, as indicated in the longitudinal section through the gutter *fig. 118.*; in which *g* is the gutter, *h* the lower course of tiles, *i* the gutter beam, and *k* hollow posts for supporting the gutter beam, and serving as pipes for conducting away the water from the gutter. Cast-iron gutters of this sort will be found peculiarly adapted for ridge and furrow hot-house roofs; and we shall hereafter show that, for all large hot-houses, this kind of roof is better adapted than any other.



*Roads very much curved in their Direction should be highest on the longest Side.* — In the making of private roads, wherever the curves or turns are rather sudden, the surface of the road on the longest side of the curve should always be made somewhat higher than on the shortest side, in order to counteract the centrifugal force acquired by a carriage going at a rapid rate. The neglect of this, in the case of sharp turns on the public roads, is one cause of the overturning of carriages; and it suggests the idea of the advantage that would result, both to road-makers and coachmen, from a knowledge of scientific principles. Were the latter aware of the nature of the centre of gravity, it may reasonably be supposed that they would be more careful in loading the roofs of their carriages, either with men or packages, so as to keep the centre of gravity low; and more cautious in driving on rough roads, and on such as have quick turns, so as to lessen the acquirement of centrifugal or centripetal force.

*An economical Hot Closet* may be formed at very little expense, by taking a common hastener for placing before a kitchen fire when meat is roasting, and closing up the front, or side next the fire, with black sheet iron; forming a door at the back, for putting in and taking out the articles to be kept hot. Black iron absorbs the heat powerfully, and the heated air within not being allowed to escape becomes very hot. When it is desired to use this hot closet as a hastener in roasting meat, it is only necessary to hang in front, before the black iron, a covering of tinned sheet iron, which may be in two or more plates, according to the size of the hastener, for convenience of lifting on and off. *Fig. 119.* is a back view of such a movable hot closet, with the door open, showing the shelves, &c. It is scarcely necessary to observe, that white sheet iron will, in many cases, be preferable to black iron; because, while it reflects the heat and hastens the meat, it will conduct and radiate quite enough into

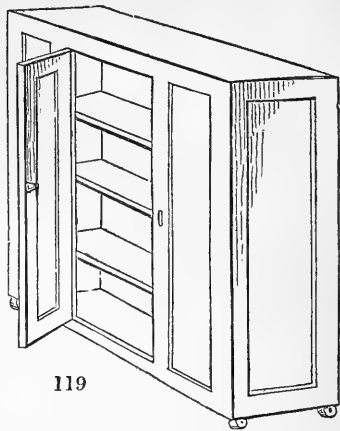
the hot closet; and what is collected there will not be so easily radiated through the tin as through the black sheet iron.

An *Egg-clock* which shall ring a bell, or set off an alarm, at any number of minutes that may be required, is formed by a dial like that of a watch, but larger, surmounted by an alarm-bell, and with five divisions, representing five minutes on the dial. This being fixed up over the kitchen fireplace, all that is necessary is to move the index to the number of minutes the egg is to be boiled. While the boiling is going on, the cook or attendant may be employed in doing other work till the alarm goes off. The act of moving the index or pointer backwards winds up this clock. The principle might be applied to a larger dial,

so as to mark the time requisite for cooking articles generally; and we have accordingly engaged a brass-founder to undertake such an apparatus. We feel confident that it will be found a most valuable addition to the kitchen furniture, both of the poor and rich, by allowing the ordinary work of the kitchen to go on without the interruption occasioned by watching, &c. Even the boiling of an egg occasions some loss of time, in watching the clock or sand-glass.

*Schools.* — At Belper and Milford there are schools in which the whole population employed in the manufactories are educated at a moderate rate, and both chapels and churches at which they may attend. As we have said before, however, this is a subject which we cannot enter on at present, and must content ourselves with expressing our admiration at the order displayed at these factories; it is highly gratifying, because it shows what may be done, and what, no doubt, will be done, when public opinion (much more effective than legislation in cases of this kind) is powerfully directed to the detection of inhumanity in manufacturing establishments.

*The Residence of Joseph Strutt, Esq., in Derby.* — In a gardening point of view, the hot-house is worthy of note for its movable front sashes, which admit of exposing the vines to the open air in the winter season, and at the same time keeping them dry, as first described in the *Horticultural Trans.*, and subsequently in the *Encyclopædia of Gardening* (see edit. 1835, p. 783.), and in Vol. VII. p. 411. of this Magazine. We first saw this vinery in November, 1826; and then, as now, both vines and pines were doing well. The vine borders are not cropped, and in winter they are thatched in such a manner as to carry off the rain and melted snow to a drain of between 20 ft. and 30 ft. distant from the front glass. In the stove there are some well-grown *Orchidæ* and other hot-house plants. Against the wall of the dwelling-house, there is an *Aristolòchia siph*, one of the shoots of which we measured, and found upwards of 50 ft. in length. In the house there is a large collection of pictures distributed through all the different rooms and staircases, but more particularly in a handsome gallery, remarkably well lighted from the roof through double sashes set at an oblique angle, the inner sashes being of ground glass, to soften the rays of the sun. It is heated by hot air, and also by small tubes filled with hot water; which, however, are only used during the most severe cold. The outer sashes in the roof protect the inner ones from dust, and also prevent the escape of heat during winter, and its entrance during summer. There are two ventilators in the upper part of the roof of the skylights, which are opaque. This gallery, like every other part of the house, is lighted by gas; and, taking into account the lighting by day and by night, the warming and the ventilation, it is one of the most complete picture galleries that we know of. In consequence of the double roof,



and double glass, very little artificial heat is required during the most severe weather, and it is always cold in the hottest days of summer. The greater part of the pictures in the gallery are by foreign artists; but one room in the house is exclusively devoted to native talent, and contains fine specimens by Hogarth, Reynolds, Morland, Wilkie, Landseer, Martin, Calcott, &c.

*In the Hot-house at St. Helen's, Derby*, the vines were formerly planted in the inside of the house, and rather too deep; but Mr. Mackay, the present gardener, planted them on the outside, in 1829, and they have since done well, and produced extraordinary crops. The glass roof, which is of the ridge and furrow kind, is entirely fixed, but it contains ventilators for admitting air, and the whole is now managed with the greatest ease. The heat is produced from a cockle stove, and a continual flow of warm air is poured into the house, in the same manner as is done in warming the Messrs. Strutt's manufactories. This warm air, in the most severe weather, is, by a very simple contrivance, more easily conceived than described, returned to the cockle, and heated and reissued to the house, so that, at that season, very little heat is lost. Several new pits have been built, which are heated partly by linings of dung, and partly by pipes of hot water. The walls for peach trees are of brick, furnished with horizontal wires, strained tight by means of screws and nuts, to which the branches are tied, without the use of nails, and without injuring the walls. Other trees are trained to wires fixed in the form of semicircles; the lower part of the stem of the tree forming the centre, and the semicircular wires being placed about 18 in. apart. The appearance reminds us of Seymour's mode of training, but it has no other connexion with that mode than the general appearance of the semicircles intersected by the radiating branches. There is much in these gardens to observe and to commend.

*The Hot-houses belonging to Jedediah Strutt, Esq., at Belper*, are contrived with great ingenuity. The glass roofs are in the ridge and furrow manner of Mr. Paxton, and the pines, grapes, and bananas are in the greatest vigour of growth, and showing abundant crops. The vines in pots were here, as at St. Helen's, and at Mr. Joseph Strutt's, uncommonly vigorous and prolific. Indeed, throughout Derbyshire, as far as we have observed, the growth of grapes in pots seems to be a main object with every gardener, and the success is most remarkable. The vine border has the bottom paved, and supported on stone piers, by which a vacuity below it is formed, into which heated air is admitted in the winter season, and the surface of the border, throughout the whole of the winter and spring, is thatched, so as to conduct the rain and melting snow to a gutter in front, which communicates with an underground drain. In short, the gardener has as complete a command of the soil containing the roots of the vines as if they were planted in pots; and this, indeed, is essential to successful early forcing. All the walks and paths, in and about the hot-houses, are formed of flag-stones raised on props; and the whole of the garden is, by this and other means, kept constantly in the most complete order and neatness. There is so much to admire and commend in this place, that we can only advise all proprietors and gardeners, who have an opportunity, to visit and study it.

*At Bridge Hill, Belper*, many of the steep walks in the pleasure-grounds are entirely of flag-stone, which, in our opinion, is peculiarly appropriate to the situation, and contributes much to the pleasure of walking, both in dry and wet weather, as well as being much more economical than gravel. All the walks in the kitchen-garden are also of flag-stone; which, though more costly than gravel at first, yet is much cheaper in the end, because it saves the expense of edgings, weeding, rolling, renewing, &c., does not harbour insects, and at all times affords the most comfortable description of walk. The forcing houses are most extensive, some of them heated by hot air, and others by flues. The back sheds, into most of which we entered, are kept perfectly clean, and all the materials and tools arranged in the most orderly manner. In one house, heated by hot air, the orange trees were covered with fruit and

blossoms, with the foliage of a deep shining green; in another, an abundant crop of grapes was ripe.

The flues, or chimneys, from all the close fireplaces in the house at Bridge Hill, are carried into one tunnel, which is conducted up the steep side of the hill, and terminates in one chimney, at such a distance from the house, that the smoke is no nuisance. All the laundry operations are carried on as described in Sylvester's *Philosophy of Domestic Economy*, already mentioned. The coals for the bed-room fireplaces are carried up outside of the house, to depositories on a level with the principal bed-room floor, thus saving much dirt and inconvenience. There is a "turn about," or barrel door, by which all articles usually carried into the kitchen, or given out from it to the farm servants, are received or transmitted, without the one party entering the house, or the other going out of it; such as milk from the cow-house, meat from the butcher, vegetables from the garden, &c. The jib-doors in the passages to the kitchen may be opened by applying the foot to a lever, like the pedal of a pianoforte, so that a servant, with a tray, or any article which requires to be carried by both hands, need not set the tray down, but, by applying his foot, may pass right on.

*Mr. Jessop's Garden, in Derby*, contains a curious variety of broad-leaved elm planted by Pontey, and named by him the *Gallows Elm*; because he found the original tree standing near a gallows in the neighbourhood of York. Though we have frequently heard of this tree, we had never before seen a fine specimen of it. When the leaves expand in May they are of a fine yellow colour, like those of the Corstorphine plane; and, indeed, the tree may be said to bear the same relation to *Ulmus montana*, that the Corstorphine plane (*Acer Pseudo-Platanus lutescens*) bears to the common sycamore (*Acer Pseudo-Platanus*). See *Arb. Brit.* art. *A'cer*.

*The Garden of Mr. Bonam, in the outskirts of Derby*, is not more than twenty yards square, but it is rendered quite a work to wonder at by the possessor, who is upwards of seventy years of age, who took to gardening late in life, and is engaged as a workman in a brewery in Derby all day. The ground is thrown into hills and pits, varied by rockwork, roots, seats, and other objects, intermixed with many curious and beautiful plants, shrubs, trees, &c. Mr. Bonam has effected every thing by his own personal labour in the evenings, and without the aid of money. He enjoys excellent health and spirits, and is enthusiastically attached to his garden.

*The Derby Nurseries* are not at present remarkable. One is occupied by Mr. Palmer, and the other, and larger, by Messrs. Wilson and Sadler. The soil is admirably adapted for the growth of trees; and some parts of it are, like the soil at Glazenwood, suitable for growing peat-earth plants without the use of peat. Great improvement is anticipated in this concern, from some recent changes in the proprietorship and management.

*Bretby Hall, the Seat of the Earl of Chesterfield*, is situated in a beautifully undulated country, and the mansion, which is in the castellated style, by Wyatt, has fine views on two sides. The building is not finished; and the gardens round it are not laid out, as they doubtless ultimately will be, in a style at all suitable to the house and the place. All that can be said in favour of Bretby Hall is, that the situation has very great natural advantages, and that there is abundance of scattered trees and plantations. Near the house is a large cedar of Lebanon, supposed to be one of the first which was planted in England. The circumference of the trunk at 4 ft. from the ground is 15 ft., and its estimated height 70 ft. It has lost several branches within the last few years, but it is still a noble tree, and being situated on a small artificial knoll, has a commanding effect. Among the pictures in the house are three portraits of this tree, taken at different times, and showing the tree in different states. The architectural details of the exterior elevation of the house shows how little Gothic architecture was understood 30 years ago, even by a master in this style, to what it is at present.

*Repton.* — Close to the church and school of this village are some remark-

ably fine broad-leaved elms. They are of great age, with trunks from 12 ft. to 15 ft. in circumference, from 70 ft. to 80 ft. in height, and still growing vigorously. In the house are some excellent imitations of wainscot in plaster; and in the exterior, some Gothic work supposed to be old, but which we have no doubt is comparatively modern.

*Swarkstone Lowes; Mr. Smith.*—This gentleman, noted as a breeder of horses and cattle, is also a great florist, and is reputed to have the best collection of tulips in Derbyshire. He possesses a great many fine sorts, and excels in several other kinds of florist's flowers and curious plants. He cultivates a particular kind of cabbage, called the early Cornish, which has large white ribs, somewhat like those of the Portugal cabbage, and which he considers far superior in flavour to any other variety. He has obligingly promised us to raise a quantity of seed, and send it to Mr. Charlwood for distribution. Mr. Smith kindly gave us some of the cabbages, which we had cooked, and found of excellent succulency and flavour. Among the shrubs in Mr. Smith's collection, we found the new mahonias, *Berberis empetrifolia dulcis*, several ribeses, and other choice species.

*Keddleston Hall; the Earl of Scarsdale.*—This noble place is well known for its superb mansion of classical architecture, its hall of lofty columns of native marble, and its gigantic timber trees. There is very little about Keddleston that we could wish to add to, or alter. We examined the lofty silver firs in the pleasure-ground, varying from 100 ft. to 130 ft., or perhaps 150 ft., in height; and the large oaks, and broad-leaved elms in the park. The plantation on the hill behind the house, however, from not being thinned in time, admits the light through the naked stems, and thus has a meagre, instead of a massive effect. An attempt is making to plant out the stable offices, which, if it succeed, will, in our opinion, injure the general appearance of the house; the dignity and effect of which they at present heighten by forming a secondary mass. We found in the pleasure-grounds specimens of laurustinus from 6 ft. to 8 ft. in height, and as much in diameter, and large arbutuses, and common and Portugal laurels, which had been but slightly, if at all, injured by the winter of 1837-8.

*Formark; Sir Francis Burdett, Bart., M. P.*—This is a very fine old place, in a state of utter neglect, which a little expense would render a most delightful residence. The house is well arranged, and contains a spacious suite of apartments, entered from an outside stair which rises to the height of 10 or 12 ft. above the ground; thus giving a most commanding effect to the views from the windows, and admitting of all the offices being above ground. This is an old arrangement, but it is a very good one in most situations; and decidedly the best on moist soils. In the kitchen-garden is a new range of plant houses, the framework of which is of iron, and the heating effected by hot water. In the park, in front of the house, is an oak tree upwards of 60 ft. high, with a trunk 18 in. in diameter, and the branches covering a space of 50 ft. in diameter, which sprang from an acorn planted by the present proprietor when an infant. We have seldom seen a place better adapted for floricultural display on the lawn front, but nothing of the kind is attempted. There are a number of mutilated aged oaks and elms near the house, mixed with numerous old yews and large hollies; the oaks, we were told, were mutilated by a steward from economical motives.

*Osmaston Hall, the Residence of S. Fox, Esq.,* is a large Italian house, and the park contains some fine old ash trees, sycamores, broad-leaved elms, English elms, and one or two Cornish elms of which we have been promised portraits. Mr. Fox is curious in all that relates to horticulture, and, as a magistrate, has been active in promoting many public improvements in Derbyshire.

*Chatsworth; His Grace the Duke of Devonshire.*—Since we last saw this place in 1831 (see Vol. VII. p. 395.), it has undergone many improvements, and of these the most remarkable is the erection of a large tropical conservatory. In general design it may be compared to a cathedral with a



central aisle and side aisles. The entrances will be at the ends, through porches, which will be treated as green-houses; and, when the whole is completed, it will cover above an acre and a quarter of ground. There will be a carriage drive through it; which will form part of a general drive through the pleasure-grounds. The conservatory is situated in an open part of a lofty wood, in nearly the centre of the pleasure-grounds, and it is unquestionably the largest structure of the kind in existence or on record. The framework of the main building, which is of wood, is all put up, and is just beginning to be glazed. It will be heated by six fires, all of which, and the means of access to them, the places for fuel, &c., will be under ground, and the chimneys carried in a tunnel up the side of a hill to the distance of nearly a furlong, so that not the slightest appearance of artificial heating, or smoke, or sheds, &c., will appear, either within the house or exterior to it. We shall not enter into details, because, when the building is finished, these will doubtless be made public by Mr. Paxton; by whom the whole has been designed, and under whose direction it has been executed. We cannot avoid noticing the very judicious manner in which Mr. Paxton has proceeded with this building, which will be completed in the most scientific, elegant, and substantial manner; and with a degree of economy, considering the immense magnitude of the structure, that will in the end surprise every one and redound greatly to his credit, and to the honour of the noble duke, his benevolent and enlightened employer.

The arboretum at Chatsworth, which is the only one that we have seen or heard of where sufficient room is given to every species to attain its usual size, we have given a plan and description of in a former volume. (XI. p. 485.) The trees and shrubs have now been planted four years, and they may be considered as firmly established, and doing well. Each tree and larger-growing shrub is planted on a little hill, the surface of which is kept dug, or at all events free from weeds, which is perhaps better; and the smaller-growing shrubs, such as heaths, azaleas, vacciniums, &c., are planted in masses in prepared soil kept free from weeds. An ample space is allowed to each plant; the effect of which, now that they are fairly beginning to grow, is already conspicuous, and will be strikingly so in five or six years. The names are in white letters on a dark ground painted on heart of oak, as described by Mr. Nesfield, Vol. XIII. p. 58.; but the letters are beginning to fade, and will be replaced by others of a different kind, and more in the manner of our brick tally, fig. 12. p. 33. in Vol. VIII. Near the palace, as it may very properly be termed, many araucarias and deodar cedars are planted, alternating with Portugal laurels trained on stems 6 ft. high, with heads cut into round balls, so as to resemble orange trees under the kind of treatment which they receive in the gardens of the Tuileries and at Versailles. A new line of separation has been formed between the pleasure-ground and the park, on the east side, which is a very great improvement. It is a high wall rising in steps as it ascends the hill, and the space between each step is thrown into a compartment by piers. Each compartment is planted with tender climbers, or other ornamental shrubs, which are trained to a trellis, and covered with a blue striped canvass curtain during nights throughout the winter and spring. During the three or four summer months, the curtain is entirely removed. This conservative wall, as it may be called, commences at the orangery, which forms part of the palace, and terminates in a stove at some distance. In this stove we found many well grown plants; and, in particular, groups of ferns on masses of rock-work, each mass being placed behind the stone piers between the windows of the front elevation. The grand cascade has been altered, but something further is wanting; the fall of the water from the aqueduct not harmonising in breadth either with the falls above or those below it. The termination of the sloping line of cascade has, like that at Caserta near Naples, always appeared to us unsatisfactory; though it would be difficult to say, both in the case of Caserta and Chatsworth, what would be the best mode of improving it. Mr. Paxton, however, having recently had the advantage, during an eight

months' tour with his noble employer, of visiting all the finest gardens of France and Italy (an advantage which we question whether any other gardener ever enjoyed), will doubtless devise some plan for giving meaning, not only to the termination of the line of cascades, but to the two ends of the oblong canal on the south front of the house.

In the kitchen-garden there is much to be learned by the young gardener; and, indeed, we do not know a better school for young gardeners in the kingdom. The forcing and cropping are, as is usual, chiefly carried on with a view to those months in the latter end of the year when the duke resides at Chatsworth; but, notwithstanding this, we saw ripe grapes, peaches, and cherries in pots. The latter are kept by most gardeners in a low temperature while the blossom is setting, but Mr. Paxton has found a high temperature, even to 70°, greatly preferable. There is less early forcing this season than usual, on account of the Duke of Devonshire being on the Continent; but Mr. Paxton informed us that, in other seasons, there is a considerable quantity of early forcing, both of vegetables and fruits, grapes being required at table all the year round, and in winter and spring 3000 pots of strawberries are forced annually. Washing peach trees over with a mixture of lime and water in autumn has been recommended by Mr. Knight, for the purpose of destroying insects; and Mr. Paxton has found it not only useful for destroying insects, but that it helps to ripen the wood, or at least to fit it for standing the frost of winter, by extracting part of the moisture from it. After a wet season, this advantage is strikingly apparent. In arranging the vines in the vineries, and the fruit trees on the walls, Mr. Paxton has, as far as it is practicable, classed each kind of fruit by itself, and trained each tree or plant of the same kind into nearly the same size and shape. Thus we have one house entirely filled with the Canon Hall muscat, a favourite grape with Mr. Paxton, another with Hamburgh grapes, others with the common muscat, and with Frontignan, and so on.

All the green gage plums are brought together on the wall, and all the Flemish pears, &c. These arrangements are for the purpose of simplifying the management, and this is carried so far, that even the number of bunches of grapes that each vine is to bear, or dozens of fruit that are to be allowed to remain on each wall tree after thinning, are predetermined by Mr. Paxton the preceding autumn or winter, according to the strength of the tree and the ripeness of the wood; and instructions are given accordingly to the foremen of that department. A certain number of currant and gooseberry bushes are trained with single stems of 3 ft. or 4 ft. in height, in open airy parts of the garden, in order to raise the fruit from the ground, and allow the sun and air to be freely admitted to it, and to render it more easily preserved by matting during autumn.

Perhaps the most important improvement which Mr. Paxton has introduced at Chatsworth is, the mode of ridge and furrow roofing which he has adopted in hot-house building. Some idea may be formed of this from two sashes figured in the first edition of our *Encyclopædia of Gardening*, p. 343., and also from the description of the ridge and furrow roof given in the same volume, p. 358.; and in our *Remarks on Hothouses*, 4to, published in 1816. The advantages of the plan are: 1. That the roof does not require to be raised so high behind; because the descent of the water does not depend upon the general slope of the roof, but on the slope of the ridges towards the furrows; and the water in these furrows, being in a larger body than ever it can be on the glass, passes along with proportionate rapidity. 2. That the morning and afternoon sun, by passing through the glass at right angles, produces more light and heat at these times of the day, when they are of course more wanted than at midday. (See our *Remarks on Hothouses*, p. 23.) 3. The rays of the sun striking on the house at an oblique angle at midday, the heat produced in the house at that time is less intense than in houses of the ordinary kind; for the reasons given above, and also for the general reason that a greater surface is presented for the light to pass through. 4. More light is admitted at all

seasons; on the principle, that a bow window always admits more light to a room, than a straight window of the same width. 5. The panes of glass may be smaller than in houses the roofs of which are in one plane, and consequently the panes will be less liable to be broken by frost. Mr. Paxton has also adopted another improvement in the construction of the sash bar, viz., having grooves for the panes instead of rebates (see fig. 120.); the advantages of which grooves are, that less putty is required, and that what is used does not so readily separate from the wood, and thus admit the wet between the wood and the putty. The roofs of such houses are entirely fixed, and ventilation is effected, either by having the perpendicular ends of the ridges movable on hinges, of which there is an example in the house erected on Mr. Paxton's plan at Mr. Harrison's at Cheshunt, a plan of which will be hereafter given; or by the front glass, and ventilators in the back wall. With regard to the expense of this mode, it is probably not greater than that of roofs in one plane; because, though more glass is required, yet it is in smaller panes, and the sash bar is also much lighter, and the rafters fewer. Mr. Paxton has promised us a paper on this subject, with a plan of a grooving saw, which he has invented to make the bars with, and will, at the same time, enter into the expense of erection, &c. There is yet another improvement which may be adopted in ridge and furrow roofs, which is the employment of thicker glass, by which means one pane may be substituted for 8 or 10, and consequently much additional light admitted and cold air excluded. In some hot-houses in the neighbourhood of London, and even in some pits and frames, it has been found worth while to glaze with plate glass in order to prevent breakage; and this new glass will form an excellent substitute for, and come much cheaper than, plate.



Having now seen this description of ridge and furrow house at Chatsworth, at the Sheffield Botanic Garden, at Mr. Jedediah Strutt's at Belper, and at Mr. Harrison's at Cheshunt, we are prepared to state with confidence, that we think the plan a substantial improvement, and one particularly adapted for green-houses and plant stoves intended to be rendered ornamental. The plan of the original house erected at Chatsworth by Mr. Paxton, with all its details, will be found in Paxton's *Magazine of Botany*, vol. ii. p. 80.; and from that plan and other sources we intend shortly to prepare an article for this Magazine, and for our *Suburban Horticulturist*.

In the paths of all the stoves, green-houses, and forcing-houses in the kitchen-garden at Chatsworth, Mr. Paxton has introduced a simple economical and beneficial improvement. This is, where the pipes or flues for heating are under the paths, to cover them with loose cross pieces of boards; each of the length of the width of the path, and about 4 in. broad; the result of which is, that, while the heat is freely admitted to ascend, the dust and other matters, when the paths are swept, descend immediately; and any length of path, on any emergency, can be rendered quite clean in a few minutes, without raising a dust in the house to disfigure the leaves of the plants, and encourage the red spider, which dust deposited in the leaves is always found to do. These boards, being all loose, can be taken up once or twice a year, and the space below cleaned out. Even when it is desired to water the paths in order to raise steam, the water sinks between the boards; and, while the latter are quite dry and comfortable for the feet, the vapour rises in abundance.

*Sheffield Botanic Garden.*—This garden occupies 18 acres, on a bank with a varied surface sloping considerably to the south. It has been laid out by Mr. Marnock, in a manner which, as far as we had time to examine it, appeared perfectly satisfactory, and decidedly in better taste than any garden of the kind which we have yet seen. In short, there is nothing in it which we could wish to alter. The arboretum and fruticetum is so arranged as to display every specimen tree and shrub from the walks; and, when these specimens shall have been a few years grown, their picturesque effect will be such that no other trees or shrubs but the specimens will be required. At present the

named kinds, which are finally to remain, are mixed with other sorts to shelter them ; but these shelter plants are few, and what is of more consequence, from being chiefly of one kind in one place, they do not even now drown, so to speak, the effect of the plants which are finally to remain. The shelter plants are chiefly Ontario poplar, a species of poplar that has creeping roots ; and which, like all trees having creeping roots, may be safely transplanted even when of a considerable size. Hence these nurse plants, as they are thinned out, are sold by Mr. Marnock to persons in the neighbourhood making plantations, or laying out small places. The nurse plants employed in botanic gardens hitherto, and more especially in the Chiswick Garden, have been a mixture of various kinds (see p. 350.), which distract the eye, and puzzle it to find out the specimen plants which are ultimately to remain ; but when the nurses are all of one species, though a general sameness is produced as well as in the other case, yet, when examined in detail, this sameness is of a more simple kind, and one which affords greater facilities for discovering the specimen plants. As a general principle, therefore, where nurse plants are to be introduced into a scientific or ornamental plantation, one kind ought always to prevail in one place. The Ontario poplar seems very judiciously chosen as a nurse plant for a scientific garden, because it comes early into leaf, and does not grow faster than the average of trees : the black Italian poplar grows much too fast, as does the larch ; but the mountain ash, the wild sorb, the common sycamore, the lime, and similar trees, are quite suitable. The greater part of the specimen trees in the Sheffield Garden are planted in masses which will finally be open groves ; but all the more hardy and vigorous-growing sorts, and many of the shrubs, stand singly on the lawn. The masses are dug ; and the direction of the margins indicating the termination of one and the commencement of another genus is such, that at the termination of each genus

121



Sàlix.

Bétula.

A'lnus.

an angle (as in *fig.* 121.) is formed in the outline of the mass. This angle always prepares the observer for a change of genus.

The herbaceous arrangement is placed by itself in beds ; and there is a reserve ground, and pits and frames for preparing plants for being turned out into the flower-beds and borders. There is a part of the garden devoted to rustic work and rockwork, which is well managed, and forms a fine contrast to the open scenery and scientific part. An attempt has been made to combine a zoological garden, but, as might have been expected, it has not succeeded. In fact, the filth, stench, roaring, howling, and other annoyances incident to carnivorous animals, are altogether inconsistent with the repose which is essential to a botanic garden, and to the enjoyment of garden scenery of every kind. The range of hot-houses in the Sheffield Garden is judiciously placed, and very handsome ; and the separate divisions are well stocked with plants, thriving as well as could be desired. Among these we observed the largest plant of *Clíanthus puniceus* which we have anywhere seen (perhaps 7 ft. high, and as much in diameter), and which was covered with an amazing quantity of bloom. Near it is a plant of *Sutherlandia frutescens* var. *obcordata*, noticed in Mr. Marnock's *Magazine*, vol. iv. p. 41., which is 5 ft. high, with fine bright scarlet flowers. A fine plant of *Cytisus Rhododáphne* has been constantly in bloom, summer and winter, for three years without intermission,

and may be safely recommended as a most desirable conservatory shrub. There are also some large bananas and palms, and many other fine stove plants which were formerly under Mr. Marnock's care in the conservatory at Britton Hall. In the stove, the Orchidæceæ and ferns are planted on roots, stumps of trees, and rockwork, so as to have a very picturesque effect, and the vigour of the plants is equal to any thing which we have seen. In the open air we found various green-house plants which had stood the winter, among which *Melaleuca squarrōsa* and some leptospermums seemed to be the hardest. A part of the range of houses is of iron and curvilinear, and a part is of wood in the ridge and furrow manner of Mr. Paxton. The sheds to these houses and all the pits and preparatory structures, are most judiciously contrived and managed; and though placed close behind the grand range, yet owing to the steepness of the ground they enjoy enough of sun for every requisite purpose. We observed here the fine effect of looking through the glass windows of a conservatory, to young trees in the open ground not much larger than those in the conservatory, and of the same general appearance. It seemed to extend the conservatory, and the enjoyments it affords, to a comparatively unlimited space; and to harmonise much better with what is within, than the view of distant scenery. A distant landscape, seen from the terrace walk in front of a conservatory or green-house, has always a very fine effect; but we do not recollect a single instance in which this is the case, where a landscape is seen through the glass of a conservatory. The truth seems to be, that the mind, in a conservatory or green-house, is so much occupied with the new kind of scenery within, that it is disturbed by any circumstance which obtrudes on it the ordinary kind of scenery without. The mind is as incapable of attending to two subjects at one time, as the eye is incapable of seeing more at any one time than is included under a certain angle.

There is a noble broad terrace walk in front of the houses, and another which proceeds from it at right angles down the slope; and it may be useful to those laying out walks on slopes, to state that the inclination of this terrace walk, though at the rate of about five eighths of an inch to a foot, or about 1 in 20, is quite agreeable to walk on, both up and down, backwards and forwards. In a practical point of view, this fact will be found of considerable importance; for example, in laying out terraces or Italian gardens, or public promenades. Judging from the view of the walk and the hot-houses on the wrapper of Mr. Marnock's *Magazine*, we were not prepared to find this the case. The whole of the garden was in good order, though the number of men employed was only three; a circumstance which may well make us blush for the state of the metropolitan public gardens. The secret of this economical and effective keeping is, that the mowing of the grass, the hoeing of the dug clumps, and the weeding of the walks, is all let out to common labourers; so that the duties of the professional gardeners are confined to the houses, the reserve gardens, and the planting out of the articles in beds. There is very little training of plants against walls or trellises, which is another source of the saving of professional labour. On the whole, as we have said before, this garden is worthy of being taken as a model for the laying out, planting, and mode of management of public botanic gardens. Mr. Marnock has evidently an excellent taste in landscape-gardening; and may be regarded, in this point of view, as a valuable acquisition to the part of the country in which he is situated. We learn with regret, that, like other institutions of the same kind, the Sheffield Garden is but indifferently supported; but, for the benefit of others, we hope sooner or later to give a plan of it in this *Magazine*.

The *Sheffield Cemetery* consists of several acres of varied surface, on a bank opposite to that on which the botanic garden is placed, and each contributes to the effect of the other. It is laid out, as cemeteries on an irregular surface necessarily must be, with winding walks, and these are judiciously interspersed with trees and shrubs by Mr. Marnock. In one precipitous part the sandstone rock is cut down perpendicularly, which may easily be formed into

catacombs at some future time. In a central situation is a handsome chapel in the classical style, and at the upper end of the ground is the officiating minister's house.

*The Birmingham Botanic Garden.* — Our readers are aware that we made a plan for laying out this garden in 1831, which was published in this Magazine, Vol. VIII. p. 410. The greater part of the plan has been adopted; the parts deviated from being chiefly the range of hot-houses, and the arrangements immediately connected with it. We proposed the hot-houses to be circular in the plan, for the reasons given in the article on the subject referred to; but for economy's sake a straight range has been adopted. This range, taking it altogether, is one of the worst in point of taste that we know of. The centre is semicircular in the front part of the plan, with a lofty dome, surmounted by a second small dome, cupola, or glass turret, not unlike in form to those sometimes put up on the roofs of offices for pigeons, and totally unfit for plants; unless we suppose that the spiry top of an *Araucaria imbricata* could be induced to rise into it; while the two sides or wings, joined to this curvilinear centre are common shed-roofed structures, not half the height of the dome. The want of harmony between the centre and the wings is most conspicuous, from whatever direction the whole may be viewed, and in our eyes it is most offensive. This impression is by no means diminished when entering these houses, by the circumstance that the lofty dome, instead of being filled with large plants, such as bananas, palms, and tropical trees, rising from the free soil, contains a stage covered by small plants in pots.

Having found fault with this range of glass, we have nothing but praise to bestow on the management of the rest of the garden, which does the highest credit to Mr. Cameron. The trees and shrubs have thriven in an extraordinary degree, chiefly owing to the soil being deeply trenched, and kept cool and moist; and the plants being placed so far apart as to be clothed with branches from the bottom upwards, and thinned out so as never to be allowed to touch each other. Another cause of their thriving is owing to the situation of the garden; which being on a slope with higher grounds above, the soil is supplied by moisture from these high grounds, and from the porous loamy subsoil, so that nothing in this garden ever suffers from drought in summer.

There is also above an acre of natural peat in the Birmingham garden, in which the *Ericacææ*, and all the American and peat-earth shrubs, and peat-earth herbaceous plants, thrive to admiration. Such masses of the more rare dwarf rhododendrons and azaleas, *vacciniums*, *kalmias*, *Andrómèda squarròsa*, and *hypnoides*, *Córnus canadénsis*, *Gaulthèria Shállon*, *Linnæa boreális*, and similar plants, we have never seen elsewhere. We also observed *Amýgdalus pùmila*, and other species of *Amýgdalus*, *Prúnus*, and *Cérasus*, which, compared with the same species in the smoky atmosphere of the London gardens, are like different species. The collection of alpine plants in pots includes many rare species, a number of which are not to be found in any other garden. The pots are quite small, and plunged in sand; under the shade of hedges. The collection of hardy herbaceous plants, as we have mentioned in p. 416., is believed to be the most complete in Britain; and every gardener will allow that no man cultivates herbaceous plants better than Mr. Cameron. On the whole, we were highly gratified with this garden, and especially with the growth of the trees and shrubs, as a consequence chiefly of the manner in which they have been managed, though partly also of the excellence of the situation. Mr. Cameron has promised us the dimensions of some of the most rapid-growing kinds; and also drawings by his daughter, Miss Cameron, of some of the rare shrubs which we had never before seen in flower.

*The Birmingham Cemetery* is small for the size of the town, but it is fortunate in being bounded on one side by an irregular cliff of sandstone, in which are being formed galleries of catacombs, in the style of those of the cemetery at Liverpool. Only a part of the grounds are laid out and planted; but this has been done very judiciously, with a great variety of trees and shrubs, by the Messrs. Pope. A classical chapel is also completed.

*The Birmingham Nurseries.* — We had only time to look at that of the Messrs. Pope, which, our readers know from the account given of their *Catalogue* in a former volume, contains one of the best collections of herbaceous plants in England, and perhaps only second to that in the Birmingham Botanic Garden.

*Aldershaw, near Lichfield, the Seat of the Rev. Burns Floyer,* is a fine old place, laid out in what might be called the transition style adopted by Switzer in the latter years of his practice. A portion of the grounds directly on the lawn front of the house was bounded on the sides by straight walls, and terminated in front in a terrace walk and ha-ha. Beyond on one side is the park, and on the other, a wood laid out in what Switzer calls the rural style; that is, a wood or shrubbery, with numerous winding walks throughout, inosculating in various ways, and in all directions, so as to create a kind of confusion, "almost as good as a labyrinth." The present proprietor has taken down the wall which formerly separated the Elizabethan garden from the woody labyrinth; and this removal somewhat injures the effect of both, more especially of the Elizabethan garden. If we were called on to improve this place with a view to retaining the present house, we should recommend the wall to be rebuilt, and the Elizabethan garden restored. A new house, however, is said to be in contemplation, in a different part of the grounds, which will doubtless require new arrangements. Some fine old cedars and other trees have recently been blown down, but the magnificent beech, the dimensions of which are given in our Vol. XII. p. 311., still exists in the greatest vigour, and will probably long do so, as it stands close to a pond. One lesson which the gardener may learn from this place, is the advantage of keeping evergreen trees and shrubs from touching each other, in consequence of which they are feathered to the ground with branches.

*Manly Hall, or Thick Broom, near Shenstone, the Seat of — Manly, Esq.,* is a new place in a beautiful well-wooded situation, with a house in a mixed style of baronial Gothic, by Mr. Trubshaw. The general effect of the exterior at a distance is good, and the work is admirably executed in stone. We had not an opportunity of examining the details of the exterior, nor the interior of the mansion; but we went through the stable offices, which are very complete. What we most admired about the place, next to the natural beauty of the situation, which is very great, is the manner in which two terraced lawns in front of the house are arranged and planted. The worst part of what has been done by art on the grounds is the approach, which crosses a meadow on an embankment, and then a "deep cutting" is made to conduct the road through a hill, thus giving it the character of a common public road between one town and another, instead of an elegant approach to a villa. Had the road been carried across the meadow inclining considerably to the right, and on the natural surface instead of on an embankment; and been then carried round a hill covered with natural wood, gradually rising as it advanced through the wood towards the house; an approach would have been formed of singular beauty, and one which would not have shown the view obtained from the lawn front of the house before entering it, as is the case with the present line of road. The gardener at this place excels in grafting, and has inserted the pendulous-branched ash on the common species at considerable heights; one we believe exceeding 40 ft. high. The grounds here are rich in native plants, especially those which grow in woods and moist places. We found *Cardamine amara*, *Verónica*, *Anagallis*, and various others. The architectural student will find Mr. Humphreys's opinion of the house in the *Architectural Magazine*, vol. v., on which account we say nothing here on the subject; but we cannot help expressing our surprise that our esteemed and intelligent friend, Mr. Trubshaw, should have produced so bad an interior in the entrance lodge. There is a great want of simplicity in the arrangement, and of light in the stairs, besides other points open to fair criticism.

*Drayton Manor, the Seat of Sir Robert Peel, Bart., M. P.,* is an extensive

place; the surface is flat, but the house in an elevated commanding situation. The house is by Sir Robert Smirke, in a style somewhat between Italian and Elizabethan; but, as it struck us, without the boldness and freedom in the turrets and chimney tops requisite for such a style. We refer, however, to the masterly observations on the architecture of this house by Mr. Humphreys, in the *Architectural Magazine*, vol. v. p. 687. to 691. We shall only notice one fault in the house, and also in the walls of one of the entrance lodges, respecting which there can be no dispute. Such faults are in architecture, what faults in grammar are in literary composition, they cannot be denied; while faults in style admit of difference of opinion. The fault to which we allude may be called the want of architectural connexion between the parts of a building. For example, the brick walls of the gate and lodge are in contact with the stone piers, but they are not united with them by the projection of part of the pier into the brickwork, or of the brickwork into the pier. The same fault is committed in the entrance porch, where a pierced parapet is joined into a panel of the corner turrets. This is as bad as placing the knocker of a door on the panel, instead of on one of the styles. There are various faults of this kind; among others that of the walls of the offices in some places rising out of the ground without a plinth or a base, while the upper parts of the same walls display stone facings to the windows, a stone cornice, and stone parapet over. These are trifles, we admit, but why should they not be attended to? The general masses of trees and shrubs in the pleasure-grounds are well arranged, with reference to the distant scenery; but, being composed of the commonest trees and shrubs, they appear behind the age in a botanical point of view. Can this have been done on purpose to suit the style of the house? If so, it has been badly done; because, though there is little variety, yet there are several species which were totally unknown in this country in the time of Elizabeth. Some standard stems of crab and almond terminate in young shoots of mistletoe of extraordinary luxuriance; which shows that that parasite can thrive, at least for a time, without a leading branch above it, of the tree on which it grows. The flower-garden is in the kitchen-garden, which, in a large place, always argues something defective in the arrangement; but, probably, it may be intended to form the lower platform into a flower-garden. Both the flower beds and the kitchen-garden appear to be well managed by the gardener, Mr. Watts.

*Elvaston Castle; the Seat of the Earl of Harrington.*— We had frequently heard this place described as a modern Palagonia, and we knew that it contained an excellent collection of the pine and fir tribe, and also of *Cupressinæ* and *Taxacææ*. We were therefore most anxious to see it, and, through the kindness of the proprietor, our wishes have been gratified. The situation is flat, or at least without any striking inequalities; but there are some fine old avenues, one of which is nearly a mile and a half in length, but the effect is that of an avenue of ten miles, in consequence of the ground beyond falling below the level of the surface where the avenue commences at the house. Upwards of seven years ago all the trees and hedges were cleared away for nearly seven miles, which came in the line, and the view is now uninterrupted until the eye rests upon the hills in Nottinghamshire, at the distance of ten miles. The effect of these avenues has been heightened in an extraordinary degree, by the formation of new ones, chiefly of the upright or Irish yew. Two of these avenues, one upwards of 750 ft. in length, and 60 ft. in breadth, and the other 800 ft. in length, are planted, first, with upright yews, and next with red cedars; with a third or back row, on each side of the avenue, of deodar cedars grafted on the cedar of Lebanon, in the side manner, as explained in our *Arboretum Britannicum*, and in the *Gardener's Magazine*, vol. xiv. p. 80. All these plants are thriving luxuriantly, and their effect will be striking in a very few years. Beyond one of these avenues, in a space occupying several acres, is an extensive collection of pines on the outside of a corresponding avenue. A similar space is allotted for the fir tribe, including *Abies* and *Picea*; the range of ground between these plantations at one end



is planted with *Cèdrus Deodàra* and *C. Libàni*, and at the other we find grouped *Taxàcæ* and *Cuprèssinæ*, a list of which is given in our *Arboretum*. The trees are all planted on little hillocks of from 6 ft. to 10 ft. in diameter, and at the centre of each hillock, from 1 ft. to 2 ft. above the level of the adjoining surface. They are planted in rows, and are growing with extraordinary vigour; ample space being allowed for each plant to attain its normal dimensions. In approaching the castle, after passing through the second gate, the first group of plants passed through is of the coniferous tribe; then a collection of hollies, including all the hardy species and varieties grown in this country, many of which are great rarities. A part of the approach road, after the first avenue terminates, is in a winding direction, bordered by evergreens, exhibiting masses, each consisting of trees of one species of *Abiétinæ*, *Cuprèssinæ*, or *Taxàcæ*, or of box trees. The number of thujas, red cedars, white cedars, Irish yews, hemlock spruces, common yews, variegated common yews, and upright common yews, is quite astonishing. To produce immediate effect, and to serve as background to these comparatively young plants, large spruce firs have been transplanted (many of them of upwards of 50 ft. in height); and these trees being held fast in their situations by guy ropes, like the mast of a ship, scarcely one of them has failed. One cause of this is, that the trees were all taken up with balls, and not moved to any great distance; and another is, that the soil is everywhere loamy and moist at bottom. In approaching the castle, we pass what appears to be an immense forest of yews; but this forest, when examined in detail, is found to consist of a series of ancient flower-gardens, surrounded by and intermixed with yew hedges, and containing yew trees of large size, brought from all parts of the country, many of which have been clipped into curious shapes. Among these, in different positions, are placed numerous plants of *Araucària imbricatà*, variegated yews, and many of the rarest *Coniferæ*. There are three extensive gardens of this sort, each occupying several acres. One, though recently planted, has quite an ancient character, with covered walks of *arbor vitæ*, and flower-beds, &c. This garden is surrounded by a terrace of yew trees, the inward line forming arches, and paneled with *Cydònia japónica*, and with *araucarias* in the open spaces. Another is an Italian garden, richly furnished with vases, statues (many of which are of grotesque forms), richly gilt, basins, fountains and other works of art. A third consists of open lawns, bounded by yews, and by trees of the pine and fir tribe. There is a fourth flower-garden just commenced, with the flower beds arranged in architectural forms, bounded by masonry. In this garden, which, like all the others, is characterised by evergreens, there are hedges of the evergreen mahonias, and beds of all the rare evergreen plants that are to be procured in British nurseries. Three of these gardens with ornamental plantations are on the entrance front of the castle, and it is quite impossible for any one who has merely passed rapidly through them, as we did, to do them anything like justice without the aid of plans and views. Among the numerous things which struck us as new and extraordinary, were plinths of soil forming pedestals to large yew trees, which were procured when full grown from different parts of the country, wherever they could be found large, or cut into curious shapes; while smaller yew trees were planted at the base of the plinths, and trained over them. The solemn gloom cast over part of the grounds by these yew trees produces an effect never to be forgotten, which harmonises with the fine old ivy-covered church adjoining the castle, which towers proudly above them, and is also in part clothed with ivy. Another front of the house looks down the immense avenue already mentioned, which is upwards of a mile and a half in length; and the third front looks on a modern lawn, with flower beds, bounded by an extensive artificial lake, beyond which, and extending all along the north side, is a plantation just formed of *Cèdrus Deodàra*: all the ground behind these cedars (forming the three front lines) is partly, and will shortly, be entirely planted with the finest of the pine and fir tribe; as *Píceà grándis*, *nóbilis*, *amábilis*, and *Webbiàna*; *Pínus Sabiniàna*, *Cóulteri*, *insígnis*, *ponderòsa*, *Lambertiàna*, *monticola*, and

excélsa; connecting it with the park. There are caves, grottoes, bridges, mounts, statues, and various other ornaments in this part of the pleasure-ground which we cannot recollect or describe.

The castle is a magnificent building externally; and the interior contains some spacious apartments, well arranged, and richly furnished and fitted up, with curious carving, gilding, stained glass, pictures, and sculptures. The offices are very complete, and the kitchen, the dairy, and the larder, are particularly deserving of notice; the latter is a lofty tower, placed over the ice-house.

The kitchen-garden is large, and it contains some new forcing-houses, admirably planned and executed, and furnished with excellent crops of pines, grapes, and peaches. The front borders for the vines are covered during winter with tiles cemented with clay, so as completely to carry off the rain and melting snow to a drain in front. These tiles are annually taken off in May, and put on again in December. The peach borders are about 6 ft. in width, and 18 in. in depth; with the bottom paved with tiles, to prevent the roots from entering the subsoil; and the surface covered with tiles, to prevent evaporation, to conduct heat to the soil, and to reflect it to the foliage against the walls. In general, all the fruit trees, both standards and dwarfs in the open garden, and trees against the walls, have a flooring of tiles under the roots, from 1 ft. to 18 in. beneath the surface. These tiles are made 1 ft. square, and  $1\frac{1}{4}$  in. thick. The crops on these trees, and the moderate state of the wood, neither too luxuriant nor too weak, prove the great advantages of the plan. Indeed, we attach so much importance to it, that we should wish much to lay Mr. Barron's practice and opinions on this point of culture before our readers. The system of covering with tiles also deserves the particular attention of the gardener. We have seldom seen such an elegant range of glass, covering plants so beautifully grown, and bearing so abundantly, as this garden contains.

In the reserve ground are many coniferous plants which are being brought forward for planting out; and those rare species, which in other places are only to be seen singly or in pairs, are here in dozens or scores.

Among single objects which we recall to memory are, purple beeches grafted at a great height on the common beech; a weeping ash grafted on a common ash at 80 ft. from the ground, and growing most luxuriantly; and many variegated yews. A drive has recently been formed round the plantations in connexion with the pleasure-grounds, about two miles in length; the ground on each side, to a considerable width has been trenched, and will be planted with evergreen trees or shrubs of a similar description to those already there.

On the whole, the grounds at Elvaston Castle abound with objects of great singularity, rarity, and value, and we can only regret our utter inability to do them justice, though our visit occupied the greater part of the day. Unfortunately, Mr. Barron, the gardener, was from home, and we were shown round by a young man who was comparatively a stranger. We trust, however, to Mr. Barron to supply deficiencies, and correct any mistake into which we may have fallen; and, above all, to give us some account of the manner in which he transplants large trees, and paves under and otherwise manages the fruit trees in the kitchen-garden.

Nine years ago there was not a single evergreen about the place, with the exception of the very large cedars of Lebanon and a few large Portugal laurels; the whole having been collected, planted, and the entire grounds and gardens formed, in less than nine years.

*The Cornish Elm* (*Ulmus campestris cornubiensis* Arb. Brit.)—This tree is seen here and there in the neighbourhood of Derby, and thence to Lichfield and Birmingham. It is readily known, even when without its leaves, by the somewhat twisted direction, and comparatively smooth bark of the main stem, and by the side branches being twisted and turned upwards; as is very well expressed in that remarkably fine specimen of this tree at Muswell Hill, which is figured in the *Arboretum Britannicum*, vol. vii. plate 184. It is also known

in spring by the leaves being a fortnight later in coming out than those of the common English elm; and in their being, when expanded, much smaller, and more pointed. Mr. Masters of Canterbury describes this tree, in our Vol. XIII. p. 30., as the red English elm; and observes that it is of rigid growth, and one of the most valuable timber trees of the small-leaved kinds of elms. The poles (for hops or other purposes) of this tree, Mr. Masters observes, are nearly of equal diameter throughout. Wherever the English elm will attain a timber size, and durable timber is the object, this variety ought to have the preference; and we would recommend those who wish to be quite certain of possessing it to apply to Mr. Masters, who propagates upwards of twenty species and varieties of elms, and has for many years paid particular attention to this family of trees. (See *Gardener's Magazine* as above, and *Arboretum Britannicum*, art. *Ulmus*.)

The following remarks apply partly to places that we saw between London and Sheffield, and partly to others which we have subsequently seen in Middlesex and Surrey. They are here brought together, because, for certain reasons, we cannot give either the names of the places, or those of their proprietors, or occupiers.

*Improving a Lawn liable to be burnt up in Summer by Drought.* — Above twenty years ago, the lawn in front of a house at B—— was more or less burnt up every summer, in consequence of the sandy nature of the soil and subsoil. We recommended taking out the subsoil to the depth of 1 ft. all over the lawn, retaining the surface soil, and mixing it with loam from a meadow at no great distance, by repeated trenchings. These trenchings were performed without intermission, during dry weather; and, we believe, above a dozen men were employed for three weeks in trenching this lawn over three times. Had we the same work to perform again, instead of manual labour we should apply Finlayson's harrow or Kirkwood's grubber, either of which implements would do the work better, and incomparably quicker. To get the work done quickly is a very great advantage; because by that means it may be completed while the weather is dry, and every one who has had any experience in mixing soils on a large scale, knows, that to do this properly in wet weather, or partly in wet and partly in dry weather, is impossible. The conditions are, that the two soils to be mixed should be in the same state of minute division, and of dryness; and that the soil to be added should first be evenly spread over the other. For want of attending to these conditions, farmers sometimes lay lime on land in such a manner that it can do little or no good; viz. when the lime is wet and the land dry, or the contrary; or when both lime and land are wet. To mix soils equally and thoroughly, and in such a way that the mixture may remain mixed, both soils ought to be as nearly as possible in a state of dry powder. Even when sand and loam, or lime and loam, are mixed in this state, owing to the different specific gravities of sand and loam, and of loam and lime, there will be a constant tendency in the mixture to separate, by the sinking of the heavier soil or earth, when the mass is moist, as explained in Vol. XIV. p. 96. Hence, all soils that are mixed artificially require to be superintended by art (so to speak) for many years afterwards, in order that they may at proper intervals of time be ploughed up or trenched, so as to remix the heavier soil with the lighter. In the case of a lawn treated as we have described in dry weather, if, immediately after mixing, the soil be rolled hard while yet dry, having been previously (if necessary) properly underdrained and sown down, it will scarcely require remixing in a lifetime; but in the case of grass lands badly drained, or from any cause liable to be soaked with water, remixing will become necessary, probably in twenty or thirty years, according to the difference of the specific gravity between the original soil and the soil which is added. Any one may prove this, as suggested in Vol. XIV. p. 97., by filling two pots of earth with soil of the same quality, placing at the bottom of one pot a layer of stable dung, and at the top of the other a thin layer of lime. After a greater or less number of years, according to the quantity of rain that has fallen on the

pots, the stratum of dung will be found at the top in the form of black vegetable mould, and the stratum of lime at the bottom tinged with yellow. The completion of this experiment may be accelerated by artificial watering, so as to exhibit the effects described within a year.

In the lawn to which we allude, the soil being dry, and with a good declivity, we found, after twenty years, the mixture nearly as homogeneous as when it was newly made; and on June 14th, though the weather had been warm and dry for some weeks previously, the grass was of a dark green, forming a striking contrast with the grass of an adjoining field, across a sunk fence, where the soil had never been mixed. We are convinced, from this instance, as well as from general reasoning, that all the dry grass lands in the country might be greatly improved by this mode of treatment; and, in many cases, so as to pay the expenses during a fifty years' lease. At all events, it would well repay, both in effect and in produce of grass, the proprietors of parks. With respect to lawns, and, indeed, kitchen-gardens, on sandy soils, it is evident that to render such soils as productive, and as retentive of moisture, as loams, must be one of the greatest improvements that can be made in them. Some may consider the plan we recommend too expensive, or, in other words, it may require more money than they can afford to lay out; but, in the case of small suburban residences, where the most is to be made of every thing, no money could be better expended. Indeed, on a large scale, say in the case of an estate of from a hundred to a thousand acres of poor sand, with loam or clay at no great distance, we should think the money laid out would at least pay as well as money laid out in the purchase of land. It is less expensive to improve sand by adding clay, than to improve clay by adding sand; because, in the latter case, the subsoil requires to be drained, and this can only be done effectually by the frequent-drain system. For example, it would be much easier to prevent the grass on the sandy parts of Hyde Park from being burnt up in hot weather, than it would to render the clayey loam of the Regent's Park so firm by sanding and draining, as not to be poached by cattle in wet weather.

*The Italian Style of Gardening*, when adopted round a mansion, though more costly at first than the English style, is kept at less expense afterwards, on account of the comparatively small portion of mown lawn which this style requires, and its definite and fixed edgings to the beds, borders, and walks. The lawn beyond the boundary of the Italian garden may always be fed with sheep, or the grass made into hay; and hence, in many cases, instead of the pleasure-ground being an annual expense, it may afford an annual profit, or, at all events, it will pay itself.

*Mowing Lawns.*—In general this is but very indifferently done by professional gardeners, or by labourers who are not much accustomed to it. We would therefore recommend that in all places where there is much lawn to mow, a man, or set of men, should be exclusively devoted to mowing it. As it is the most laborious of all country labours, such men ought either to have higher wages, or, what is preferable, the work ought to be let to them by contract. We are strongly inclined to think that the mowing of the lawns, the keeping of the walks, the hoeing, and the weeding, of all large places might be so let, much to the advantage of all parties concerned. A labourer who is accustomed to do work by the job soon becomes a very superior being to one that works by the day. In one of our earlier volumes, we have recommended classing the labours of a garden as common and professional; and, as far as possible, letting the whole of the former to common labourers, while the gardener was employed only in professional operations. The practice has been long adopted at Flitwick House, and we have lately seen it in operation at various gentlemen's seats.

*Keeping Shrubberies.*—Much labour is spent in this way to very little purpose. Shrubberies, and all other plantations, when young, ought to have the surface of the ground kept free from weeds; and, for a year or two, forked over or slightly dug; but, wherever the trees and shrubs cover the surface,

or very nearly touch each other, very little digging or hoeing is necessary ; provided care be taken to grow one set of trees and shrubs as undergrowths, which shall cover the soil and keep down all weeds, and another set of trees allowed to attain their full growth, which should be those that are to remain as standards. For want of adopting some system of this kind in the management of shrubberies and young plantations, they not only become an annual expense, but that expense is employed in rendering them unsightly ; for what can be worse than to see ground hoed and raked among haggard-looking shrubs and naked-stemmed trees, which seem to be incapable of deriving any benefit from culture. The practice of endeavouring to grow flowers and flowering shrubs on the margins of shrubberies should seldom be continued more than two or three years after the shrubbery is planted ; because they cannot thrive, and their sickly etiolated appearance is any thing but ornamental. In short, as we have often before stated, flowering shrubs and flowers never thrive among ordinary shrubs and trees, and therefore ought not to be planted among them.

*Thickening Strips and Belts which have never been thinned.*— The quickest way of doing this is to cut down a number of those trees that stole ; but the most effective mode, if the plantation contains pines or firs which have not lost their lower branches, is to cut them down to within 6 or 8 feet of the ground, leaving the whole of the strength of the roots to be thrown into the remaining side branches. The Scotch pine and the spruce fir treated in this way form admirable low growths, and very soon render a narrow strip quite impenetrable by the light. We have recently seen this in various instances, both in the north, and in Surrey. Where there are no branches on pines and firs nearer the ground than 10 or 12 feet, the trees might be cut down at such a height as to leave two tiers of live branches, and the whole or a part of these might be tied down to the remaining part of the trunk, by which they would first descend to the ground and spread along the surface, and afterwards the extremities of the shoots would grow up from it so as to form a dense evergreen mass. Of all the faults in the management of plantations, with which the country abounds, there is none so common as that of leaving narrow strips of plantation unthinned, by which the very intention of these plantations is most effectually defeated.

(To be completed in our next.)

---

ART. II. *Botanical, Floricultural, and Arboricultural Notices of the Kinds of Plants newly introduced into British Gardens and Plantations, or which have been originated in them ; together with additional Information respecting Plants (whether old or new) already in Cultivation: the whole intended to serve as a perpetual Supplement to the " Encyclopædia of Plants," the " Hortus Britannicus," the " Hortus Lignosus," and the " Arboretum et Fruticetum Britannicum."*

*Curtis's Botanical Magazine* ; in monthly numbers, each containing seven plates ; 3s. 6d. coloured, 3s. plain. Edited by Sir William Jackson Hooker, LL.D., &c.

*Edwards's Botanical Register* ; in monthly numbers, new series, each containing six plates ; 3s. 6d. coloured, 3s. plain. Edited by Dr. Lindley, Professor of Botany in the London University.

*Paxton's Magazine of Botany, and Register of Flowering Plants* ; in monthly numbers ; large 8vo ; 2s. 6d. each.

*The Floral Cabinet* ; in monthly numbers, 4to ; 2s. 6d. each. Conducted by G. B. Knowles, Esq., M.R.C.S., F.L.S., &c., and Fre-

derick Westcott, Esq., Honorary Secretaries of the Birmingham Botanical and Horticultural Society.

*PAPAVERACEÆ.*

*Glaucium rubrum* Dec. This plant Dr. Lindley considers to be the same as the *G. elegans* of our gardens. (*B. M. R.*, No. 78., July.)

+ *Papaver amœnum*. A beautiful annual poppy, raised by the Horticultural Society from seeds sent from the north of India. The leaves are glaucous, and flowers vermilion, with a white base. (*B. M. R.*, No. 80.)

*Malvaceæ.*

*Málva mauritànica* L. The plant usually sold in the seed-shops under this name Dr. Lindley considers to be merely "a large state of *M. sylvêstris*;" but he adds that the true species has been lately recovered from Algiers by the French, who have dispersed it under the name of the zebra mallow. (*B. M. R.*, No. 82., July.)

*Leguminosæ.*

1235. EDWA'RDSIA  
*Macnabiæna* Graham Mr. MacNab's ☼ or 6 jlau Y ..... ?1820. C co Bot. mag. 3735.

"This strikingly handsome shrub," says Dr. Graham, "has been for many years in cultivation in the Botanic Garden, Edinburgh, having now a stem which measures 11 in. in circumference; but when or whence it was introduced we do not know." It differs from *E. grandiflora* in its nearly equal petals, the wide separation of the petals of the keel, and its flowering when in full leaf. It was named by Dr. Graham in honour of Mr. Macnab, of the Botanic Garden, Edinburgh. (*Bot. Mag.*, July.)

*Acácia cuneata* Benth. This plant (from the Swan River) has flowered at Vienna with Baron Hügel. (*B. M. R.*, No. 74., July.)

*Philadelphaceæ.*

1479. PHILADE'LPHUS 30449 láxus *Bot. Reg.* 1839, 59.

*Compositæ.*

+ *Centaurèa pulchra* Dec. This very beautiful annual was raised, in the present year, in the Horticultural Society's garden, from seeds collected in the north of India by Dr. Falconer. The flowers are blue, deepening to violet in the centre, with a silvery involucre. (*B. M. R.*, No. 84., July.)

*Gesneriæcæ.*

1698. GESNE'RIA  
*stricta* Hook. & Arn. upright ☼ □ or 5 jl S South Brazil 1834. C pl Bot. mag. 3738.

This handsome species resembles in habit the *G. scéptrum* of Martius; "but the flowers are very different in shape; the corolla having a remarkable curvature on the upper side, and, following its direction, the style is singularly geniculated at its base; the upper lip, too, is much longer; the style and anthers exerted." Roots of this plant were sent by Mr. Tweedie from Rio Grande, in South Brazil, to the Glasgow Botanic Garden, where they produced flowers for the first time in July, 1835. (*Bot. Mag.*, July.)

*Epacridæcæ.*

504. E'PACRIS  
*coccineus* Paxt. scarlet ☼ □ or 3 mr.ap S hybrid 1838. C co Paxt. mag. of bot. vi. 123.

A very showy kind of *E'pacris*, on account of its scarlet flowers and yellow anthers; raised by the gardener of Alderman Copeland, at Leyton, in Essex, probably from seed of *E. impréssa*. It is observed, in describing this plant, "that seedling epacris vary so exceedingly in colour in their native districts. that it is impossible to establish specific distinctions, or even varieties, upon the hue of the flowers alone. Were we to act in accordance with this statement, we should be constrained to consider our plant a mere casual departure from the usual colour of *E. impréssa*. In bestowing upon it a specific designation, therefore, we are bound to declare upon what we believe its claims to that position to rest." Notwithstanding this declaration, we do not think the writer justified in distinguishing a plant by a specific name which he ac-

knowledges to be only a variety. If this is to be adopted as a principle, and followed out in naming new plants, it will add greatly to the present inextricable confusion which exists in almost every genus. The same object would have been obtained by naming this *E'pacris* *E. impressa coccinea*. We shall not occupy space here to show the importance of this subject, but rather refer to the *Arboretum*, vol. i. p. 8. and p. 216. (*Part. Mag. of Bot.*, July.)

*Asclepiadaceæ.*

778. **CEROPE'GIA**  
*vincaefolia* Hook. Vinca-leaved ☞ ☒ cu 20 s P Bombay 1837. C 1p Bot. mag. 3740.

A vigorous-growing stove climber, with dark purple flowers. It is a native of Bombay, and was sent to the Glasgow Botanic Garden by J. Nimmo, Esq. (*Bot. Mag.*, July.)

*Boraginaceæ.*

435. **CYNOGLO'SSUM**  
*caelestinum* Lindl. celestial blue ☞ ○ or 2 B.w North of India 1837. S co Bot. reg. 1839, 36.

A hardy biennial, the seeds of which were sent to the Horticultural Society, from Bombay, by John Nimmo, Esq. The flowers are blue and white, and very pretty; but the whole plant has a heavy and unpleasant smell. The seeds should be sown, and the plants treated, like those of the giant Brompton stock. (*Bot. Reg.*, July.)

*Scrophulariæcæ.*

45. **VERO'NICA**  
*diosmæfolia* Cunn. Diosma-leaved ✖ or 3 ap L V. D. L 1835. C 1.p.s Flor. cab. no. 106.

A very pretty little shrub, growing about 3 ft. high, and producing a profusion of pale lilac blossoms. It was introduced from Van Diemen's Land in 1835, by J. W. Compton, Esq., and flowered in the Birmingham Botanic Garden in April, 1838. Though grown against a wall in the Birmingham garden, it appears very nearly hardy, as it stood out without protection during the severe winter of 1837-8. (*Flor. Cab.*, July.)

+ *V. formosa* R. Br. An evergreen hardy shrub, with white flowers, a native of the highest mountains in Van Diemen's Land. "Its power of existing in water," says Dr. Lindley, "is quite extraordinary. I have a specimen now before me, of which a twig, placed in a phial of water, has lived six weeks, ripened its seeds, and is now as fresh and healthy as it was at first." (*B. M. R.*, No. 85., July.)

*Proteæcæ.*

+ *Grevillea Thelemoniâna* Hugel. "A beautiful New Holland shrub, with numerous racemes of crimson flowers, and narrow pinnatifid leaves." It was brought to Europe by Baron Hugel, with whom it has flowered at Vienna. (*B. M. R.*, No. 72., July.)

*Thymelæ'a.*

+ *Pimelæa prostrata* Vahl. This is the pretty little shrub called in the nurseries *P. Növæ Zelândiæ*; and it is said to be a native of arid mountains in New Zealand. (*B. M. R.*, No. 81. July.)

*Orchidæcæ.*

2558. **BLE'TTIA**  
*Parkinsoniæ* Hook. Mr. Parkinson's ✖ ☒ cu 1 ja R.Y.P Mexico 1838. D p.l Bot. mag. [3736.]

Very nearly allied to *B. refléxa*, but with narrower flowers, which are of a lively rose colour, the lip and column being beautifully variegated with yellow and purple. The bulb is terrestrial and gibbous; the scape is 2 ft. or more long, slender, and jointed, with brownish sheathing bractæas at the joints. (*Bot. Mag.*, July.)

2547. **DENDRO'BIUM**  
*Jenkinsii* Wall. Captain Jenkins's ✖ ☒ pr 1 my Y Gualpra 1838. D p.r.w Bot. reg. [1839, 37.]

A pretty little plant, though very inferior in beauty to most of the other species of the genus. It is a native of India, whence it was sent to Messrs. Loddiges by Dr. Wallich. (*Bot. Reg.*, July.)

+ *Dichæa ochracea*. "A small Demerara plant, with narrow leaves, and pale yellow-ochre-coloured flowers." (*B. R. M.*, No. 71., July.)

+ *Epidendrum Candollei*. A Mexican plant, nearly allied to *E. ásperum*. "The flowers are dull brown, with a dull yellow lip, striped with the same colour." (*B. M. R.*, No. 77., July.)

+ *Oncidium unicorne* Lindl. The flowers are pale yellow, with a singular horn on the lip, from which the plant has been named. "Messrs. Rollissons imported it from Rio." (*B. M. R.*, No. 76., July.)

*Iridæcæ.*

116. *CROCUS speciosus* *Bot. Reg.*, 1839, 40.

This species is described and figured in the *Supplement to the English Botany*, t. 2752., and is there referred to the *C. speciosus* of Bieberstein. Dr. Lindley states that he does "not perceive any thing in the short account given by Bieberstein at variance with this plant;" but he adds that Mr. Herbert, who has studied the genus with care, is "opposed to this conclusion." It is a native of Transylvania and Hungary, as well as Britain. (*Bot. Reg.*, July.)

*Hæmodoræcæ.*

*Conostylis juncæa* Hugel. "A pretty green-house herbaceous plant, found on the south coast of New Holland by Baron Hugel, and raised at Vienna, where it has flowered." (*B. M. R.*, No. 73. July.)

*Liliæcæ.*

1016. *LILIUUM* 30173 *auranticum* *Part. Mag. of Bot.* vi. 127.

30175 *Thunbergianum* *Bot. Reg.*, 1839, 38.

## REVIEWS.

ART. I. *Catalogue of Works on Gardening, Agriculture, Botany, Rural Architecture, &c., lately published, with some Account of those considered the more interesting.*

*REPTON'S Landscape Gardening, and Landscape Architecture. A new Edition, with Notes, Biographical Notice, and copious General Index.* By J. C. Loudon, F.L.S., &c. Being the entire Works of the late Humphrey Repton, Esq., on those Subjects. Originally published in one folio and three quarto volumes; and now comprised in one volume octavo. Illustrated by upwards of two hundred engravings. To be completed in twelve numbers, forming one volume octavo, Price 30s. plain, or 66s. coloured. Lond. 1839. No. I., 8vo, p. 25. to 80., Price 2s. 6d., or with the engravings coloured, 5s. 6d.

Mr. Repton's celebrity as a landscape-gardener is too well known to require that we should do more than notice the circumstance. His published works have been hitherto altogether beyond the reach of the practical gardener; and we therefore consider that we are rendering an essential service to the profession by editing an edition which, instead of costing 20*l.* and upwards, will cost only 30*s.*

In this octavo edition, all the engravings in the large edition will be given, reduced so as to come within an octavo page; and, as the greater number of these engravings are landscapes, diagrams, sections, and plans, we can state with confidence that they will answer all the purposes of illustration for which they were intended, as well as the plates in the large edition. Nay, we will go farther, and state that, as we have given a separate engraving for every slide, Mr. Repton's ideas will be rendered more clear by our plates than by his own. This will apply not only to the coloured, but to the plain, copies.

We are anxious that the young gardener should possess this work for his own sake, as well as ours; and we recommend him to take it in as published,



and make himself master of every chapter as he goes on. The first article to which we would direct attention is, a note giving the philosophical reasons why, in certain cases, a vignette is preferable to a landscape bounded by definite lines. The next article treats of different characters and situations; and the two remaining chapters in Number I. treat of buildings, and the proper situation for a house.

Again we say that this work will be of immense service to the young gardener, whether he wishes to fit himself for laying out a flower-garden, or a whole place.

*The Forest Planter and Pruner's Assistant; being a practical Treatise on the Management of the Native and Exotic Forest Trees commonly cultivated in Great Britain; respecting which every useful Information is given.* By J. Main, A.L.S. 10 coloured plates, pp, 251. Lond. 8vo, 1839.

An excellent little practical work, founded on scientific principles, and on the extensive experience of the author, well known and justly esteemed both as a writer and a practitioner. It is not intended in this work, Mr. Main observes, "to notice every thing that may be written of forest trees; nor to describe, or even name, every tree-like plant found in woods." The common and most useful species of forest trees only will be described, accompanied by "practical remarks on their culture and management, and with particular reference to the necessary and important business of pruning them when young, in order to insure the production of clear-grained and most valuable timber." — (Pref.)

A copy of the table of contents will be the shortest and most effectual mode of doing justice to the author, and informing the reader.

Chap. i. Preliminary Remarks; Aboriginal Forests, how destroyed, present Remains and Management. Chap. ii. On Planting, different Methods of, Obstacles in the way of. Chap. iii. On the Defects and Necessity of Pruning, how far practicable, Effects and Advantages of. Chap. iv. Suitable Soils for Trees, Clay, Loam, Sand, Subsoils, Moor and Bog Earth, wet and dry Soils, Trees suitable for. Chap. v. Treatment of wounded Trees, Causes of Wounds, topical Applications, Damage from Insects or other Animals. Chap. vi. Qualities of Timber, Ponderosity, Hardness, Toughness, Durability, Dry Rot, Kyanising. Chap. vii. On Coppice Woods, Description and Value of, Management, &c. Trees suitable for. Chap. viii. On pruning the Pine and Fir Tribes, why so necessary, Evil of Neglect, Rules of performing. Chap. ix. Pollard Trees, their Stations and Uses, how planted and managed, Kinds. Chap. x. Longevity of Trees, Information concerning, Knowledge of wanting. Chap. xi. Miscellaneous, felling, grubbing, &c. Fencing, absolute Necessity of, different Methods of, Botanical Distinctions of Trees. List of British Forest Trees.

*Iconographie du Genre Camellia, ou Collection des Camellia les plus beaux et les plus rares, peints d'après Nature, dans les Serres de M. l'Abbé Berlèse.* Par M. J. J. Jung, Artiste, Membre de la Société Royale d'Horticulture de Paris; avec la Description exacte de chaque Fleur, accompagnée d'Observations pratiques sur la Culture de cette Plante, et des Soins qu'elle exige pour fleurir abondamment. Par M. l'Abbé Berlèse, Secrétaire de la Société Royale d'Horticulture, &c. Folio, 1ere Livraison, 2 coloured plates, pp. 2. Paris, 1839.

In our preceding volume, p. 200., we reviewed at length the *Monographie du Genre Camellia*, by the Abbé Berlèse; and the title given above shows that this gentleman's enthusiasm has led him to commence an *Iconographie* of the same popular exotic shrub. Two plates, and their descriptions, are before us, and we can only say that the former are well drawn and coloured, though much inferior to the plates in Chandler's work, and that the descriptive letter-

press is everything that could be wished, unless we except, in p. 1., the circumstance of the origin of the specific name *Derbyana* not being given; and in p. 2., that *Swètii vèra*, the name of a variety dedicated to Mr. Sweet, "*C'est à M. Swet qu'on l'a dédié,*" is misspelt.

*Vegetable Organography; or an Analytical Description of the Organs of Plants.*

By M. Aug. P. De Candolle, &c. Translated by Boughton Kindon. In monthly parts, 8vo, 2s. 6d. Parts IV. to VI. for May, June, and July, from p. 145. to p. 288. London, 1839.

We are happy to be able to state that this work proceeds, and improves, particularly in the plates; and we again strongly recommend it to every young gardener.

*Essays on Natural History, chiefly Ornithology.* By Charles Waterton, Esq.

With an Autobiography of the Author, and a View of Walton Hall. 3d ed. pp. 334, 8vo. London, 1839.

In a previous volume we have strongly recommended these *Essays* to the gardener, on account of the information which they contain respecting birds, often considered the enemies of gardeners, but in reality his best friends. This third edition contains some essays never before published, and among these is one on the weasel, from which we make the following extract:—

"The weasel, like the wood owl, is a great destroyer of beetles; and it is known to make incessant war on the mole, the mouse, and the rat; the last two of which draw most extravagantly on the hard-earned profits of the husbandman. These vermin seem to constitute its general food; and we must allow that it arrests their increase, by an activity and perseverance truly astonishing. It hunts for the beetle in the grass; it follows the mole through her subterraneous mazes; it drives the rats from the bottom of haystacks, and worries them in the corn-ricks, and never allows them either peace or quiet in the sewers and ditches where they take up their abode. That man only, who has seen a weasel go into a corn stack, can form a just idea of the horror which its approach causes to the Hanoverians collected there for safety and plunder. The whole stack is in commotion, whilst these destroyers of corn seem to be put to their last shifts, if you may judge by the extraordinary kind of whining which goes on amongst them, and by the attempts which they make to bolt from the invaded premises.

"But, of all people in the land, our gardeners have most reason to protect the weasel. They have not one single word of complaint against it, not even for disturbing the soil of the flower-beds. Having no game to encourage, nor fowls to fatten, they may safely say to it, Come hither, little benefactor, and take up thy abode amongst us. We will give shelter to thy young ones, and protection to thyself, and we shall be always glad to see thee. And fortunate, indeed, are those horticultural enclosures which can boast the presence of a weasel; for neither mouse, nor rat, nor mole, can carry on their projects with impunity, whilst the weasel stands sentinel over the garden.

"Ordinary, and of little cost, are the apartments required for it. A cart load of rough stones, or of damaged bricks, heaped up in some sequestered corner, free from dogs, will be all that it wants for a safe retreat and a pleasant dwelling." (P. 302.)

*Instructions for collecting, rearing, and preserving British and Foreign Insects; also for collecting and preserving Crustacea and Shells.* By Abel Ingpen, A.L.S. & M.E.S. Small 8vo, second edition, 3 coloured plates, pp. 106. London, 1839.

In the present enlightened age, when even the labourer may know, and is expected to know, something beyond his occupation, we would particularly draw the attention of the young gardener to the study of insects, a branch of natural history that connects itself very closely with botany. With the aid of a slight knowledge of entomology he may soon distinguish his real enemies

from his supposed ones, and, at the same time, disperse the clouds of many an old superstition by making himself acquainted with their economy.

The first thing that presents itself on commencing the study of a department in natural history is, the best method of collecting and preserving the objects; the little book before us is intended to give the requisite instructions for "collecting, rearing, and preserving" insects. It has the great merit of being concise, and written in a popular style, so as to be easily understood by the young entomologist. The whole has been rearranged, and some new matter added; and it is altogether got up in a much better manner than the first edition. We would recommend it to the young gardener, as giving the best and the shortest instructions for collecting, &c.; and we will make the following quotation from the Introduction, in the hope that it may stimulate him to pursue the study of entomology.

"There are few objects in nature which raise the mind to a higher degree of admiration than the insect creation. Their immense numbers, endless variety of form, astonishing metamorphoses, exceeding beauty, the amazing minuteness of some, and the complex and wonderful organisation of others, far exceeding that of the higher animals—all tend to prove an almighty artificer, and inspire astonishment and awe!

"But in reviewing the amazing endowments of these endless tribes of beings, which administer so much to the gratification of our mental and ocular faculties, the great utility and important advantages derived from many of them, have also another claim upon our regard. The delicious luxury furnished by the *bee*, and the beautiful dye of the *coccus*; the materials for an exquisite fabric, prepared by the *silkworm*, which gives employment to millions! and the ingredient produced by the *gall fly*, to which mankind is deeply indebted for the promulgation of knowledge! are all real benefits. And from others, lessons of industry and economy, virtue and morality, perfection in various arts, and even civil government may be learned; and, accordingly, some have been held up as models of conduct, and referred to for instruction in wisdom from the days of Solomon." (*Introduction*, p. 14.)  
—W. A. M.

*The Science of Drawing; being a progressive Series of the characteristic Forms of Nature. Part I. Trees.* By Frank Howard. 8vo, 16 plates, pp. 46. London, 1839. Price 4s.

We have often been asked by young gardeners to recommend them a drawing-book, but we have never yet met with one that contained all the instructions for drawing which a gardener requires. Some elementary drawing-books treat of landscapes, others of figures, others again of flowers, and one or two works, such as Hassel's *Camera*, profess to teach all these topics. There are still wanting instructions in plan and map drawing, adapted to garden purposes; and also in architecture, adapted to the designing of hot-house buildings and other garden structures. It is not easy to say when such a book will be produced; but in the meantime the young gardener cannot do better than copy, with the pen and common ink, all the drawings of single objects which he finds in this Magazine, or in any other gardening publication. We say single objects, because there is no more difficulty in copying them, than in copying the letters of the alphabet. The copying of objects in combination, that is pictures, is quite a different thing, and what no young gardener need attempt before he can draw single objects, such as tools, utensils, flowers, roots, trees, houses, &c., with ease, accuracy, and expedition. Those gardeners who are learning to do this will find the work, the title of which is placed at the head of this article, an excellent guide for the drawing of trees; and those who are farther advanced will be instructed in what may be called the philosophy of drawing by the two works by the same author, the titles of which follow this notice. The object of these two works is to teach the young artist how to combine

objects, and to shade and colour them so as to make pictures; while the object of the little work, the title of which we have given above, is to teach the delineation of single objects on sound and simple principles. The perusal of the two following works, and of Gilpin's *Essay on Prints*, will greatly assist young men in acquiring a knowledge of what is right and wrong in pictures; or what is to be imitated or avoided in natural or artificial landscape. It is surprising, as we have elsewhere observed, that the Horticultural societies, and especially that of London, do not offer prizes for drawings by gardeners, and particularly for ground plans, maps, sections, and other drawings of garden structures.

*The Sketcher's Manual; or, the whole Art of Picture-making reduced to the simplest Principles, by which Amateurs may instruct themselves without the Aid of a Master.* By Frank Howard. 8vo, 28 plates, pp. 79. London, 1837. Price 7s. 6d.

The following extract from the advertisement will give the reader a very good idea of the object of this work. Most of the numerous works on the art of drawing and painting, which have been called forth by the almost universal desire to draw, are liable to objections. The elementary works "describe the mode of holding the pencil, represent the particular touch adapted to delineate certain trees, and provide drawings, varying in complexity and difficulty, as examples for the student; but they give no principles upon which the examples are, or drawings in general should be, made: they give no indication of what constitutes a picture.

"The objects in a drawing may be accurately outlined, and shaded very correctly, very neatly and delicately finished, and yet it shall be less pleasing than a light sketch, having no pretension to accuracy of outline or detail, but which possesses the charm of pictorial effect. The term picture is here used in a general sense, as meaning an agreeable object, or combination of objects, for contemplation; and pictorial effect is the term applied to that quality which distinguishes a picture from a diagram or map.

"In what does this magical power consist? Is it difficult of comprehension or attainment?

"The answers to these two questions will not be found in any work on the art, whether elementary or scientific. Yet there can be no doubt, that the desideratum with amateurs and artists, and particularly with sketchers, is not only to represent forms, but to make pictures; to place the object or objects before the spectator, under pleasing circumstances, or with what is termed pictorial effect.

"The deficiency, it will be the endeavour of the present work to supply.

*Colour, as a Means of Art; being an Adaptation of the Experience of Professors to the Practice of Amateurs.* By Frank Howard. 8vo, 17 coloured plates, pp. 106. London, 1838. Price 10s. 6d.

"In the *Sketcher's Manual*, the general principles of making pictures in black and white, or, as it is technically termed, in *chiaroscuro*, have been briefly, but, it is hoped, distinctly explained. The following work on colouring proceeds upon the same method. It treats, first, of the arrangements of masses of colours, which have been established by various masters or schools, and which have been recognised as satisfactory or agreeable by the public voice; it then points out the abstract principles to which these several arrangements may be referred; and, finally, directs attention to the qualities of colouring in art, which are requisite, as regards the imitation of nature." (Pref. p. 7.)

"What is *known* of art, may be as easily communicated as any other fact, and as easily acquired as a knowledge of history, or any other appeal to the memory, and is indispensable, equally to the critic and to the amateur." (*Introduction*, p. 14.)

*The Mirror of Literature, Amusement, and Instruction: containing Original Essays, Historical Narratives, Biographical Memoirs, &c. &c.*, Vol. XXXIII. 8vo, pp. 424, with numerous engravings on wood, and a steel-plate portrait.

In p. 180. we have given the title of this work more at length; and in that page, and in various others through our volumes, we have strongly recommended it, on account of the excellence of its matter, and very low price. The present volume is more than usually interesting to the gardener and agriculturist, on account of a number of articles exhibiting a "Popular view of Natural History," by Mr. Fennell, the well-known writer on the same subject in the *Gardener's Gazette*. These articles appear to be carefully drawn up, and cannot fail to be extensively useful.

*Tea; its Effects, medicinal and moral.* By G. G. Sigmond, M.D., F.S.A., &c. 8vo, pp. 144. London, 1839.

Agreeable and interesting reading. The author anticipates the driving out of the evil spirit in the working classes of the West, by the comparatively intellectual beverage of the East; and nothing can be more gratifying than this prospect, which is also rational, and gradually being realised. To accelerate its progress, the working classes must be furnished with recreations in the evenings, and on Sundays, after church service. Tea as invariably leads to thinking and conversation, as gin and porter to intoxication or at all events to stupefaction; and therefore the working classes cannot reform on tea alone, but must also be supplied with the harmless amusements requisite for a clearer state of the mental powers.

It appears, that both green and black tea are made from the same species, *Thea viridis*, but that various other kinds are also used. We lately sent to the city for some cheap tea, said to be genuine, and which we found to be of very good quality; and when we examined the leaves, in the presence of several practical botanists, we all agreed that they were those of *Caméllia euryoides*.

*The Stranger's Intellectual Guide to London*, containing an account of the literary and learned societies and institutions; exhibitions and curiosities; museums, libraries, public and private collections, colleges, and medical institutions; botanical, horticultural, and zoological gardens, &c., of the metropolis; with every information requisite for promoting objects of taste, or literary and scientific research; by Abraham Booth, F.A.S., F.S.S., member of the British Association for the Advancement of Science, &c., is in the press.

## MISCELLANEOUS INTELLIGENCE.

### ART. I. *General Notices.*

*MILIUM effusum* and *Elymus geniculatus*. — I comply with a wish which you express (p. 301.), by enclosing a small packet of seeds of *Milium effusum*, a grass which, both as an herbage and forage plant, and also for its farinaceous seeds, should be no longer neglected. I have begun to cultivate it on a large scale. Although a sylvatic plant naturally, it grows freely in exposed situations; and in woodlands would be valuable in producing food for pheasants, along with the *Elymus geniculatus*. When these two plants shall become general favourites, and their culture be extended in woodlands, pheasants will find plenty of food, and even cover, which may prevent their depredations in corn fields, too often the fertile source of heart-burnings between landlord and tenant. This packet of seeds will, I trust, be acceptable to your esteemed correspondent, W. P. T. — *Archibald Gorrie. Annat Gardens, May 9. 1839.*

*Melilotus* as a Forage Plant.—I am decidedly of your opinion, that live stock dislike *Melilotus*. The *M. officinalis*, and a variety with white flowers, with ordinary culture will reach the height of 5 ft. ; but, by the time they reach that height, they are too hard and wiry to be easily eaten, and at no stage whatever of their growth are cattle fond of them. This, however, will not lessen my obligation to you for the seeds of *M. arborea* from Bokhara (see p. 300.), which I shall carefully cultivate, and send you the result. — *Id.*

*Kühnia cupatorioides*. (See p. 144.)—The seeds you sent me have come up; but not so those of the Canadian lily, which will probably not vegetate till September next; for I find that, in a general way, the seeds of bulbous-rooted plants vegetate about the time which the parent bulb begins to show signs of vegetation.—*D. B. Kingsbury, June 8.*

We have introduced this sentence for the sake of the general principle which it contains; and to set an example to young gardeners, of scientific generalisation. On referring to all Mr. Beaton's papers in the different volumes of this Magazine, there will be found in them a constant tendency to philosophise on the subject which he has in hand; a most valuable quality of mind in a practical man, and one which, in these days of all-pervading science, no gardener can be expected to rise to the top of his profession without acquiring.—*Cond.*

*Disinfecting Nightsoil*.—In France, the eminent chemists, Messrs. Payen and Buran, have recently discovered a method of instantly rendering nightsoil perfectly inoffensive, by arresting chemical action, and yet preserving the substance of the manure, without rendering any part of it insoluble in water, or otherwise diminishing its fertilising properties. This manure is said to be extensively used in France; and a French gentleman, M. Poittevin, who has taken out a patent for the manufacture of it in England, is preparing it on an extensive scale in the neighbourhood of Whitechapel. It is said to be much cheaper than any other concentrated manure; and, being in a state of powder, may be sown broadcast over growing crops, or drilled in with turnip or other seed.—*F. F. Hampstead, July 10.*

*Insuring the Prolificacy of the Hautbois Strawberry*.—The old Hautbois strawberry was formerly held in much higher estimation than it is now; chiefly because it has ceased to be productive. One reason has been given for its barrenness, namely, that its constitutional character as a bisexual flowering plant is changed into one which is truly diœcious. All plantations lately made, therefore, if filled with an undue proportion of either male or female plants, yield fruit in such very small quantities, that the cultivator meets disappointment.

To cure this defect, it has been advised to intermix the sexes with more precision, in order to insure a crop. This we have seen tried very carefully, but without the expected success: but, in following up the experiment, a valuable fact has been the result. A practical man, who knew nothing of the parts of fructification, nor of the classes of Linnæan botany, discovered that, in order to make the hautbois<sup>2</sup> fruitful, it must be intermixed, not with any of its own species, whether male or female, but with any other free-flowering sort, no matter which. This we have seen done with complete success, and think it well worthy of imitation, wherever the excellent hautbois is particularly wanted.

This result is so much like what is so perfectly practicable in causing shy-bearing species or varieties of other plants to be fruitful by the artificial admixture of the pollen, that we cannot withhold assent to the rationality of the practice.—*J. M. Chelsea, July 12. 1939.*

*The Milford Pea*.—This is a large pea, resembling the marrowfat in size but inferior in flavour. It grows about 4 ft. high, boils very green, and promises to be a most valuable addition to our garden peas. The seed was received from Italy three or four years ago, and Mr. Young has been raising it for sale, and will have a supply of seed for gardeners by next autumn, at a moderate price.—*John Scott. Milford Nursery, July 11. 1839.*

*Sóllya heterophýlla* var. *linearis*.—This variety has been raised from seed

in the Milford Nursery. The leaves are not half the breadth of the common variety, and twice their length, and the flowers are of a darker blue, and produced much more freely than in the common species. The seeds were received by the Rev. Mr. Callicot of Pepperharrow, from a friend on the Swan River. Altogether it seems a very desirable variety. — *Cond.*

*Daguerre's Photography* (that is, Daguerre's mode of drawing or delineating by light) appears to be one of the most wonderful inventions that ever were made, and promises to effect important improvements in many delineations that have reference to botany and gardening. M. Daguerre produces "pictures of objects by reflected light, and in an incredibly short space of time. By his process, it seems only necessary to expose a sheet of his prepared paper to a ship, a temple, a clump of wood, or a street of houses, to obtain, in two or three minutes, a drawing of the whole, more minute in its details, and more perfect in its proportions, than the most skilful artist could produce." Sir John Robison, who is the first English gentleman to foresee the importance of this invention, and to give an intelligent account of it (see *Athenæum* of June 8. 1839), had an opportunity of satisfying himself that the pictures produced by Daguerre's process have no resemblance to the photogenic drawings, also created by light, except in the absence of colour. "They are as perfect images of the objects they represent, as are those which are seen by reflection from a highly polished surface. The perfection and fidelity of the pictures are such, that, on examining them by microscopic power, details are discovered which are not perceivable to the naked eye in the original objects, but which, when searched for there by the aid of optical instruments, are found in perfect accordance: a crack in plaster, a withered leaf lying on a projecting cornice, or an accumulation of dust in a hollow moulding of a distant building, when they exist in the original, are faithfully copied in these wonderful pictures." (*Jam. Journ.*, No. liii.) In a letter to us, Sir John observes that M. Daguerre's discovery will be "a precious gift to publishers, as it enables them to procure accurate drawings of the most complex objects at a trifling expense, for the use of their engravers. A dozen exquisite views of York or Westminster cathedral, under different effects of light, may be obtained at less expense than an inaccurate sketch of a cottage can be got for at present: even your *Arboretum* may benefit by occasional dead calms enabling you to get identical portraits of fine trees.—*J. R. Edinburgh, June 12. 1839.*"

---

## ART. II. Foreign Notices.

### FRANCE.

*A NEW Tile for Roofs.*—When I was in Paris, I saw at l'Exposition a portion of roofing made with a form of tile which was new to me, and, I suspect, is really so. It is the best thing of the kind I ever saw, and is, perhaps, preferable to slate. It must be nearly wind and water tight, yet has no other overlap than a neat locking joint; it is, consequently, comparatively light, yet it is so well bound together, that it runs less risk of being disturbed by wind than heavy slates do. In short I think the pattern well worthy of being adopted and introduced in this country. The tiles are manufactured by machinery, at No. 75. Rue de Vaugirard, by Romain, Jean, et Co., where some other excellent articles are executed in brick earth, and where you will be able to get specimens and descriptions for insertion in your supplement to the *Encyclopædia of Cottage, Farm, and Villa Architecture.*—*J. R. Paris, May, 1839*

### AUSTRALIA.

*The Sydney Floral and Horticultural Society.*—We have very great pleasure in laying before our readers the following account of this Society, of the existence of which we were not before aware. It is particularly gratifying to see that any taste or improvement which prevails in England is speedily adopted

every where else ; and, whether it be a taste for flowers, the establishment of railroads, or a desire for post-office reform, it is speedily echoed throughout the whole civilised world. We cannot help here participating in the regret expressed by the writer in the Sydney newspaper, that our esteemed friend, Alexander M'Leay, Esq., F. L. S., is not at the head of this Society. Surely there can be no greater friend in Australia to botany and horticulture, both theoretically and by example, than Mr. M'Leay.

We give the article exactly as it stands in the *Sydney Monitor* ; but, in future, we shall, of course, abridge accounts of this kind :—

If the Floral Society has not, as we understand is the case, exceeded all expectation in its rapid increase, the present half-yearly show-meeting certainly has. And, as in human affairs, you cannot stand still, but must either go forwards or backwards, the managers of this Society must do more for the crowding visitors the next half year, than they were either prepared or able to do at the late show.

The saloon of the Royal Hotel is large enough, but the show-tables must not be placed any more in the centre of the room. Boards covered with green baize (not too wide) must be arranged next the walls around the room, at the next show, and in the recesses of the windows ; and on these must be placed the flowers and fruits. The centre of the room will then be free for the company to move about in, freely and without fatigue. On Wednesday you could not move with ladies without great trouble ; and the weather being hot, elbowing your way was fatiguing to ladies. Many, therefore, took but a slight view of one side of the show-tables, and not finding seats left. It was, indeed, necessary that many should thus leave early, in order to make room for the crowds which poured in about twelve o'clock.

The colonial wines should not be introduced at the February show. It is too hot to taste them. The spring show is the best time for tasting our colonial wines. The corks, too, of the sample bottles should all be ready drawn, and plenty of wine glasses should be at hand. Two of the committee (elders) should be in attendance on the sample bottles. The gentlemen of the committee should all be in attendance with ribbons at their coat breasts, wands of office in their hands, and devote themselves to the business of the day, and facilitate the intention and objects of the meeting, especially in seeing that the ladies are accommodated with seats, and in all other respects. All the fruits and flowers should have labels inscribed in a legible hand, with the name of the fruit or flower, and the name of the grower. Without the grower's name, it is nothing.

For want of knowing the names of the growers, as well as the names of the fruits and flowers, the greater portion of the interest and pleasure of such a show is lost. To see a beautiful and surpassing fruit or flower, is instantly followed by three questions,—what is the name ? who grew it ? where did it come from ? The grapes should be distinguished on the labels, between wine grapes and table grapes.

In short, as the public is evidently desirous to patronise these shows, and to attend them in great numbers, such desire on their part must be met by corresponding trouble and expense on the part of the Society.

The stewards for the day should comprise a dozen youths of from 15 to 18 years of age. They could be got from the schools and colleges. These should be constituted the stewards for the day, subject, however, to the advice and direction of two gentlemen, of at least twice their age, and as much older as may be. A dozen youths, of good manners, should thus take charge of the fruits and flowers, and answer the interrogations of the company. Such a duty, with a corresponding dress, and the wand of office, would be an object of an innocent, if not laudable, ambition of our college students. It is a national object, and worth a holiday. Previously to opening the doors, each youth should be at his post, and each should have a portion of the covered table allotted to his particular superintendance. Each youthful steward should be perfectly master of the names of the fruits or flowers under his



charge, and, above all, the names of the growers. But, in order that references to the youths for this sort of information might not, by its repetition, become irksome to them, let every dish of fruit, or vase of flowers, be labelled, the label being inscribed in a legible hand, with its name, and also the name of the grower.

Better arrangements must be made next time to receive the Governor. In order to this, the doors should not be opened until His Excellency's arrival, and the Governor and suite should enter first. And on his entrance, the president, managers, and youthful stewards, with their ribands at their breasts, and their wands of office, should all be arranged in due order to receive him. When the Governor and suite had all passed into the room, then let the public follow. The Governor would be able to make his inspection before the room got too full, and thus might leave without being incommoded. The band should strike up "God save the King," on His Excellency's entering the room, and "Rule Britannia" on his leaving. If the Governor do attend these meetings, let His Excellency be received with the state and dignity becoming the Queen's representative, and also becoming a people attached from centuries back to the pomp of monarchy.

The band playing lively and pathetic airs ever and anon, during the show, had an excellent effect. It was out of no disrespect to the Governor, that his entré and exit at the late show was so private. Many did not know he had been there, until he was gone. The real fact is, the Society has outgrown its management. The managers were not prepared to govern its gigantic growth and sudden expansion in the way which they required.

The following are the prizes which were awarded:—

*Fruit. Grapes:* The best sample of wine grapes, W. Lawson, sen. Esq.; 2d ditto, Mr. J. Kenyon; 3d ditto, Mr. R. Henderson: the best sample of table grapes, Sir John Jamison; 2d ditto, Mr. Andrew Lang; 3d ditto, W. Lawson, sen., Esq.; 4th ditto, Charles Marsden, Esq.; 5th ditto, Mr. J. Rickards. *Pine-Apples:* Mr. S. Levien. *Apples:* Ribston pippin, Mr. J. Kenyon; strawberry apple, W. C. Wentworth, Esq.; cider apple, Mr. J. Kenyon; baking (Mobb's royal), Mr. J. Kenyon. *Peaches:* Late Newington, Mr. Bellamy. *Pears:* Swan's egg, W. C. Wentworth, Esq.; bergamotte, Mr. Bellamy; baking (shepherd), Mr. Bellamy. *Plums:* Green gage, Mr. J. Kenyon. *Figs:* Mr. E. H. Statham. *Pomegranates:* A. B. Spark, Esq.

*Flowers:* The best dahlia, Mr. H. S. Green; 2d ditto, Miss Jane Shepherd; 3d ditto, Mr. Brown; Agapánthus umbellátus, Mr. Robert Henderson; *Brunsvígia* Josephinæ, Mr. Robert Henderson; *Amarýllis* reginæ, Amateur; *Cólchicum* autumnále, Mr. H. S. Green; Tiger lily, Mr. M'Knight; Crocus, Mr. Henderson; Passion flower and Heliotrópium, Mr. Henderson. *Herbaceous:* Arctótis, A. B. Spark, Esq.; Adam's needle, A. B. Spark, Esq. *Shrubs:* Fuchsia, Mr. Thomas George Henderson; *Tacsònia* pinnatistípula, Thomas Smith, Esq.; *Passiflora* Loddigèsia, Amateur; *Bignònia* radicans, Mr. R. Henderson. *Annuals:* Double balsam, Mr. Baptist; sweet basil, Mr. M'Knight.

*Vegetables:* Potatoes (pink-eyed), rhubarb, asparagus, celery, garlic, broccoli, and tomatoes, Mr. Baptist; cucumbers, salad, turnips, beet-root, cabbages, Scotch kale, leeks, peas, Mr. M'Knight; potatoes (kidney), carrots, kidneybeans, silver onions, Mr. Brown; pumpkins, Mrs. Shepherd; water melons, W. Lawson, Esq.

Judges: Messrs. Anderson, Oliver, and R. Driver.

The band of the 50th was in attendance, by permission of His Excellency the commander of the forces, to whom the Society is much indebted for this mark of attention to the amusement of the public; for the Society is, although scarcely a year old, become a public institution of the most popular kind, 98 gentlemen having added their names on Wednesday as subscribers. The value of the prizes distributed was 30*l*.

"It has been remarked, and we cannot account for the fact, that Alexander M'Leay, Esq., a member of the Linnæan Society, has given no countenance

to this rising institution." (*Australian.*) This remark of our contemporary displays great want of judgment: it may be the forerunner of party discord. Mr. M'Leay is not at all to blame. To the support of benevolent and religious institutions, Mr. M'Leay is not backward; and his rank, when he is applied to, would require his being placed at the head. We think that if Mr. M'Leay were applied to as a patron of this association, together with the late Chief Justice, who is a horticulturist, and also Sir John Jamison, as another horticulturist, so far as being the first who formed a terraced vineyard in the colony, it would be well; for we presume the governor would not feel any disrespect in having such gentlemen associated with him as patrons. But the Floral Society has originated in, and is at present conducted by (and we hope will continue to be conducted by) the second and third classes of our society. Let our magistrates give their laudable countenance, but let them not accept office in the Society, and thereby extinguish those humbler lights of the colony in their aristocratical blaze, who at present manage the Society with credit to themselves and satisfaction to the public.

The show of grapes was beautiful. The vintage grape was particularly splendid. In coming to their decision on the qualities of the grapes exhibited for the silver cup, the judges were somewhat puzzled, inasmuch as one description of grape, the produce of Mr. Kenyon's orchard, was pronounced to be the best in itself, but another lot (Mr. Lawson's) contained the best and greatest variety. The secretary was referred to as to the wording of the resolution, when it was found, that the silver cup was to be given for the best sample of wine grapes, which being interpreted by the judges to signify the best variety, the cup was awarded to Mr. Lawson. (*Sydney Monitor*, Feb. 15. 1839.)

---

### ART. III. *Domestic Notices.*

#### ENGLAND.

*THE Horticultural Society's Exhibition in the Chiswick Garden on May 18. June 15. and July 6.,* were equal, if not superior, to those of former years, both as to the objects exhibited and the attendance. The show of plants on June 15. was by some considered the best that had ever appeared in the garden. Among the plants the Orchidææ were most remarkable in each of the three exhibitions, more especially those sent by Messrs. Rollisson, and by Mr. Rucker. At the last show there was a plant beautifully in bloom of *Lisianthus Russellianus*, the finest plant sent home by Drummond, and one rather difficult to grow well. (See Vol. XIV. p. 140.) At these exhibitions there were several models of flower-gardens, formed of green moss to represent turf, sand for gravel, and flowers stuck together in little masses, to represent flower-beds filled with flowers. These models exhibited a considerable degree of merit, and in many cases would be useful in giving an employer ideas beforehand. The idea occurs, that it would be well to encourage the production of models, not only of flower-gardens, but of kitchen-gardens, and of parks and plantations, showing the massing and grouping of the trees; but more especially of rockwork, for nothing is more common in gardening, and nothing worse done. To give prizes for plans and other drawings connected with gardening would also be productive of good, as well as for models of new implements, utensils, &c. Indeed, something of this kind is done by the Caledonian, the Dumfries, the Stirling, and other societies in Scotland, and by some of the provincial horticultural societies of England.

*A Society for promoting the Improvement of the Working Classes*, by the establishment of Sunday evening lectures, on various scientific subjects popularised, is now being established in London. At present, the working man has no mode of passing his Sunday evenings, but in his own family, or in the public house. In his own family, such is the lamentable condition of human

nature in this country, he too frequently does not find those qualities in his wife and children, which would be likely to induce him to stay at home; because a man who has been engaged all the week in active exertion does not find all that he wants in mere cessation from labour, and in domestic din. Scientific lectures will rouse his mind, and his wife will participate in the recreation. The consequence, it may reasonably be expected, will be the neglect of the public house for the lecture-room, in the winter season; and for public walks and gardens during the summer months. The greatest praise is due to the promoters of this philanthropic scheme, which we most sincerely hope will answer the end proposed. The praise will be the greater, as the scheme will doubtless meet with considerable opposition from prejudices generally, and more especially from those persons whose interest it is to keep the working classes in their present state of ignorance, and, too often, sottishness. — *Cond.*

*Trees blown down at Knowsley Park.* — The number blown down, or rooted up, is 3287, of which about 3000 are fir poles, consisting of larch, spruce, and Scotch pine, which have been chiefly sold for coal-pit props, railings, crate-wood, &c. About 300 large trees were blown down. The coniferous species blown down were growing on soft undrained land, and crowded together. Trees will never root strongly, even on dry soil, when they are crowded together, much less in a wet undrained situation. You will perceive, after all, that Lord Derby's loss among his plantations is not so great as appears, when we look only at the number of the trees. With the exception of a few old trees, and forty old thorns in the park, and the limbs of some of the old trees in the park, being so broken as to damage the trees both as to appearance and durability, the plantations, on the whole, may be said to be improved by the thinning given them by the storm. — *William Somerville. Knowsley Park, March 29. 1839.*

#### SCOTLAND.

*Avery's Rotatory Steam Engine adapted to a Threshing-Machine.* — Mr. Allan, one of the most extensive and talented farmers in the neighbourhood of Edinburgh, has lately had one of Avery's engines, as improved by Ruthven, applied as a substitute for horses to his threshing-machine. This remarkably simple machine consists of nothing more than a circular box of cast iron, 5 ft. in diameter, and 6 in. wide, in which are two revolving arms, from the extremities of which the steam is emitted, and the motion is produced on the principle of Barker's mill. The engine has neither beam, piston, parallel motion, apparatus, crank, nor valve; and it occupies so little space, that, exclusive of the boiler, it could be put with ease into a common parlour book-case. The price of an engine of this kind, of six-horse power, is about 120*l.*, and it will thresh from 4 to 5 quarters of grain per hour; or thresh, winnow, clean, and fit for being sent to market, 50 sacks of corn in six hours. The consumption of coals is less than 1 cwt. per hour. This engine promises to effect a revolution in the application of steam power to threshing-machines, in all coal countries. Even if it had no other advantages over the ordinary steam-engines, than that of not being liable to go out of order, this alone would recommend it before all others to the farmer. For further details, see the *Scotsman* of May 29. 1839. — *Cond.*

---

#### ART. IV. *Retrospective Criticism.*

*In the Second Additional Supplement to the Hortus Britannicus* the species of the genera *Viscaria* and *Vesicaria* have been inadvertently placed together under *Viscaria*; hence the species *Viscaria gracilis* and *grandiflora* should be *Vesicaria gracilis* and *grandiflora*.

*The Catalogue of the Birmingham Botanic Garden*, p. 413.—In your *Gardener's Magazine* for this month (p. 413.), I find some observations on the first part of the catalogue of the trees and shrubs which are growing in the Birmingham Botanic Garden, and for the imperfections and inaccuracies in which I am alone responsible. My reason for troubling you with this letter is, to correct an error into which you have fallen. You say that you presume it was printed in 1838, and subsequently to your *Arboretum*: that is not the fact. It was printed in 1834, five years ago; and I am, and then was, aware that it contained errors, but that was unavoidable, under the circumstances in which it was written. Your *Arboretum* was not then published, and the only authority I then had to refer to was De Candolle's *Prodromus*, and the last edition of Loddiges's *Catalogue*, which latter, I was informed, was considered pretty accurate. I therefore took many on the authority of that *Catalogue*, where I could not have a sufficient specimen to satisfy myself; and I did not dispute the authority of De Candolle.

It must be evident to you, that, for *Triacanthos*, *honey locust* could not be the translation, but that the three-spined, or perhaps more correctly, three-thorned, was accidentally omitted. As regards your expression, "generally literally translated," I think you will find no publication in which the translation is less erroneous, and, when errors do occur, they are evidently typographical, and not a translation: as, for instance, in *Crataegus*, *C. indentata* is given *spiniest*. Now, it must be evident that could never have been intended for a translation, even by the merest tyro; and also in *Rosa*, *R. Dahurica* is translated *Dahurica* instead of *Dahurian*; and one or two other similar mistakes, which arose in consequence of my absence from Birmingham at the period of the printing of that part. I shall take an early opportunity of examining this part of the catalogue with your *Arboretum*, and correcting the mistakes into which I have fallen. In conclusion, I thank you for the favourable manner in which you have expressed yourself.—*Fred. Westcott*. 3. *New Bridge Street, Birmingham, July 4. 1839.*

The error which we fell into arose, as we have stated (p. 413.), from there being no date to the preface or titlepage, or, in fact, to any part of the catalogue; a very injudicious practice in any author or publisher, and one that is always looked on with suspicion by authors, publishers, and more especially by critics. In the case of the *Birmingham Catalogue*, the omission of the date was, we have no doubt, purely accidental; for we do not for a moment suppose that Mr. Westcott would omit the date on principle. With respect to the literal translation of the specific names, Mr. Westcott seems to have misunderstood our remarks. When we say "the specific names are literally translated, though not always, as in the case of *Gleditschia triacanthos*, which is made the honey locust," we neither intended to praise, nor blame, but merely to state the fact; for, not being able to conceive how the substitution of honey locust for three-thorned could be an error of the press, we concluded that the specific names were not translated literally on principle, as in the *Hortus Britannicus*. We are glad to find that Mr. Westcott approves of this practice, first adopted by ourselves, as a principle, in the *Hortus Britannicus*, but neglected, or only occasionally practised, in most of the botanical periodicals of the day.—*Cond.*

*Native Countries and native Habitats of Plants.*—In reading the *Gardener's Magazine* for December, 1838, vol. xiv., at p. 552., I have noticed your very just remarks regarding the want of a catalogue (or map, rather) containing "the entire range of the plants, both geographical and physical; and the elevation in feet, and the latitude in degrees," &c., in which each particular species of plant grows. I hope you will excuse the liberty I have taken in pointing out a work that I have accidentally seen, in which you will find a map, and other information on this subject, that I should think, through the means of the *Gardener's Magazine*, would be made known to, and much appreciated by, young gardeners. I allude to a work on "Physical Geography," from the seventh edition of the *Encyclopædia Britannica*,

by Professor Traill of the Edinburgh University : and this work on "Physical Geography" is in one volume 8vo, and published very recently here by Messrs. Adam and Charles Black, booksellers. You will find in the 8vo work, at p. 226., a map containing the various species of plants, from those that are *subterranean*, to those on the most lofty mountains in the world, with a scale of the elevation in feet above the level of the sea. Professor Traill's section (ix.) in the same work, p. 226., and on the "Geographical Distribution of Plants," is extremely curious and valuable ; and, I should think, unknown to most young gardeners. I have taken the liberty of pointing out this work to you, as you may not be aware of it ; and it will afford me great pleasure indeed, if this information is of any use to you.—*A. M., being a frequent Reader of the Gardener's Magazine. Edinburgh, Dec. 6. 1838.*

We take in that very excellent work, the new edition of the *Encyclopædia Britannica*. The article alluded to is certainly extremely interesting and instructive, and is well worth the perusal of gardeners ; but nothing short of a list of species, taken from properly constructed local floras, would answer the end which we have in view.—*Cond.*

---

#### ART. V. *Botanical Expedition to Columbia, and melancholy Loss of Messrs. Wallace and Banks.*

THESE two collectors, who were sent from the gardens at Chatsworth in March, 1838, were drowned on the 22d of October in the same year, in endeavouring to pass one of the rapids on the Columbia river, when within a few days' journey of their destination. The following notice of this expedition, projected with a view to the discovery of new plants on the north-west coast of North America, may be interesting to such of our readers as do not see *Paxton's Magazine of Botany*, where the details are given at length.

Mr. Paxton, conceiving that much of the territory on the north-west coast passed over by the late Mr. Douglas was but very imperfectly examined, and therefore still presented an inviting and prolific field for research, designed an expedition to these regions, the expenses and proceeds of which were to be shared by a select number of subscribers. "This project was promulgated in November, 1837, and "was immediately countenanced and supported by all the more influential and distinguished patrons of horticulture, to whom application was made." The management of the whole was intrusted to Mr. Paxton, who "selected and prepared two intelligent, active, and enterprising young men, Robert Wallace and Peter Banks, from the gardens at Chatsworth, who left London in one of the Honourable Hudson's Bay Company's vessels for New York, in March, 1838 ; carrying with them every requisite and comfort for their voyage, and every facility for the promotion, as agreeably and successfully as possible, of the objects of their subsequent tour." Mr. Wallace appears to have been married, and to have taken his wife with him ; a practice common among religious missionaries, but rather a new circumstance in the history of botanical collectors. The Hudson's Bay Company afforded every assistance in their power, and that in the very handsomest manner. They gave Messrs. Banks and Wallace a general letter of recommendation, and a money credit, to and on all the agents in charge of the district posts in the Hudson's Bay Company's service ; and it is from one of their resident officers that the account of the melancholy loss of these young men was received by the Company in London.

Messrs. Wallace and Banks having arrived in New York, went thence to Montreal, and next to La Chine, at a short distance from that town. Here they were detained by ice till the 2d of May ; on which day they commenced their route to the Columbia river, and the last letters received from them were

dated Norway House (a station of the Hudson's Bay Company), July 20th. They were then in good spirits, and busy making preparations for departure. They left this post a few days afterwards, and had descended a considerable distance down the Columbia river, when on the 22d of October, in the evening, "while running one of the rapids below Dalles des Morts, the boat unfortunately filled," and the two botanists, including ten other persons, one of whom was Mrs. Wallace, were lost.

The tract over which the travellers passed having been previously fully explored, it was not to be expected that they could collect any thing worth sending home. Mr. Paxton concludes with the following paragraph:—

"When time has in some measure allayed the sorrow and disappointment occasioned by this grievous catastrophe, and the affairs connected with the expedition have been fully investigated and adjusted, it will remain for decision whether another attempt to prosecute the design to which these young men have so haplessly fallen victims shall be hereafter ventured on." (*Mag. of Bot.*, vol. vi. p. 137.)

---

#### ART. VI. *Proceedings of the Horticultural Society of London.*

AUGUST 21. 1838. — *Ordinary Meeting.* The following objects were exhibited: from Messrs. Mountjoy, nurserymen, Ealing, *Passiflora nigelliflora*, a species nearly related to the well known *P. foetida*. The flowers were surrounded by a curious glandular fringed involucre, which, it was stated, produces some curious phenomena of motion, and presents a beautiful appearance if viewed in water under a microscope. The oily matter contained in the glands is apparently expelled with some force into the water, where it causes eddies and a disturbance of a remarkable kind. From Messrs. Rollisson and Sons, nurserymen, Tooting, a magnificent specimen of the beautiful new Japan lily, called *Lilium speciosum*, together with *Maxillaria vitellina*, a rare Brazilian epiphyte, and *Renanthera coccinea*, in great perfection. Of the latter, it was stated that the probable cause of its so seldom flowering in collections might perhaps be found in the dissimilarity between its treatment in gardens and its natural habits. It is a common plant at Macao, where it is planted in pots of the hard mud of the country, and runs over old walls, producing its gaudy panicles of scarlet flowers in abundance annually. During the warm season it pushes forth vigorous branches, and clings by its long twisted roots to any substance it may be placed near; but, during winter, it is exposed to a temperature of 40° Fahr.; and in the spring it is parched by cold north winds, which are so dry as to split timber, and to produce much inconvenience to the human constitution. From Mr. John Breese, gardener to Sir Thomas Neave, Bart., of Dagnam Park, a noble bunch of the Cannon Hall muscat grape. It was very like the figure published in the *Transactions of the Society*, vol. i. n. s. p. 169. fig. 5., but was larger in all respects; and it fully established the claim of this valuable variety, to be placed on a level, in point of excellence, with the muscat of Alexandria. In the opinion of Mr. Breese, it even excels that variety, as it is earlier, and has but one stone in a berry. From the Society's garden, a collection of flowers, among which were *Fuchsia cylindrica*, a pretty new diœcious species, with scarlet flowers, from Mexico; and *Ledocárpon pedunculare*, a little-known half-hardy Chilian shrub, with clusters of large brilliant yellow flowers.

---

THE  
GARDENER'S MAGAZINE,  
SEPTEMBER, 1839.

---

ORIGINAL COMMUNICATIONS.

ART. I. *Description of a Plant Case, or Portable Conservatory, for growing Plants without fresh Supplies of Water and Air, according to the Method of N. B. Ward, Esq.; with Physiological Remarks.*  
By DANIEL ELLIS, F.R.S.E.

(Read to the Botanical Society of Edinburgh, June 13. 1839.)

TO THE EDITOR OF THE "GARDENER'S MAGAZINE."

SIR,

IN compliance with your request, I now send you an account of the experiment made here of the mode of growing plants in close glass cases, as practised by Mr. Ward. The delay in answering your letter has arisen from the desire of continuing the experiment to the end of the year. The paper, as you will see, was read to the Edinburgh Botanical Society a few weeks ago, nearly in the state it is now communicated to you. It is accompanied by a copy of the design of Mr. M'Nab for a glass case, which, as forming a piece of ornamental furniture, has been much approved. To this account I have appended some physiological remarks, being an attempt to explain "the appearances on scientific principles," which, in your opinion, has not yet been satisfactorily done. I am, Sir, very truly yours,

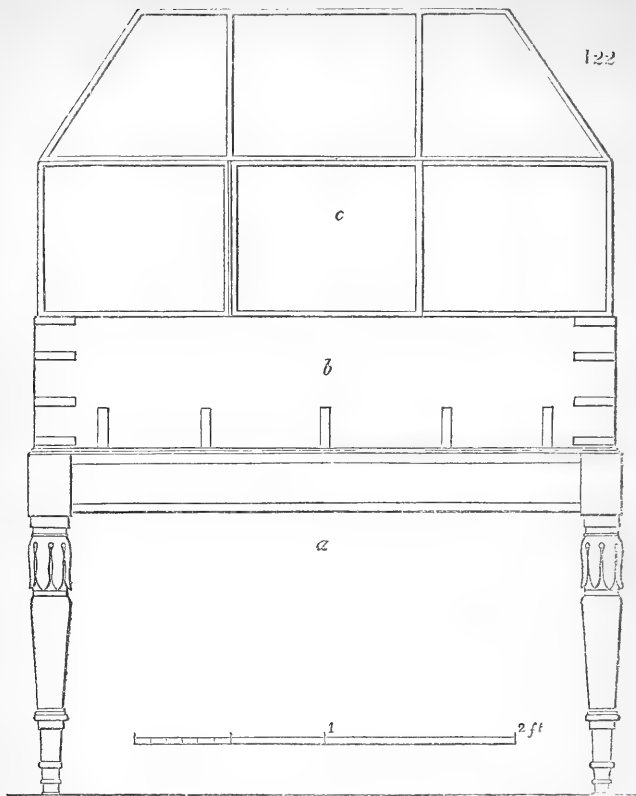
Edinburgh, June 29. 1839.

DANIEL ELLIS.

---

1. *Construction of the Plant Case.*

THE plant case, or portable conservatory, which I am about to describe, was constructed somewhat more than a year ago, under the immediate direction of Mr. James M'Nab, superintendant of the Caledonian Horticultural Society's garden. Mr. M'Nab had repeatedly visited the collection of Mr. Ward, at his house in Wellclose Square, London, and expressed so much admiration of the success of his plan, that I became desirous of getting a case made, more especially as Mr. M'Nab kindly offered to give the design for its construction, and superintend its execution. From the first, it was my wish to consider

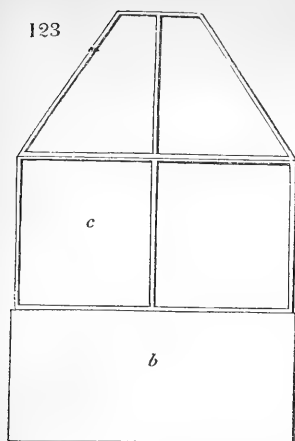


*Elevation, showing one Side of the Stand (a), Box of Earth (b), and Glass Cover (c).*

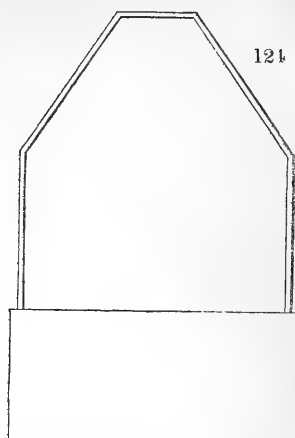
it as a sort of experiment, open to the inspection of such persons as might take an interest in the subject; and, as its success involves questions interesting alike to the botanist, the physiologist, and the horticulturist, I have thought that a concise account of the results of one year's experience, accompanied with some physiological remarks on the growth and condition of plants placed in such novel circumstances, might not be unacceptable to the Botanical Society, which has so recently done me the honour of admitting me as one of its members.

Some gentlemen having expressed an intention of fitting up cases for the same purpose, I have requested Mr. M'Nab to furnish me, not only with a copy of his design, but also with a statement of the leading particulars which require to be attended to in the construction. As the apparatus was to be placed in the window of a drawingroom, its form and dimensions were determined in accordance with that idea. It is composed of three



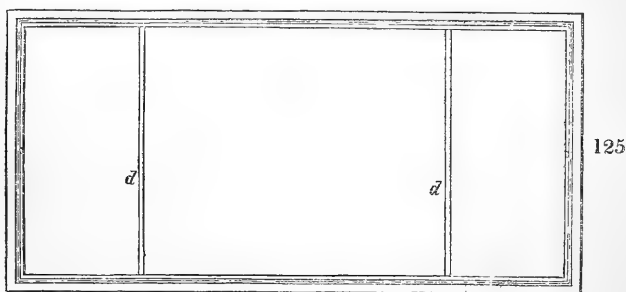


Elevation of one End of the Box (b) and Cover (c).



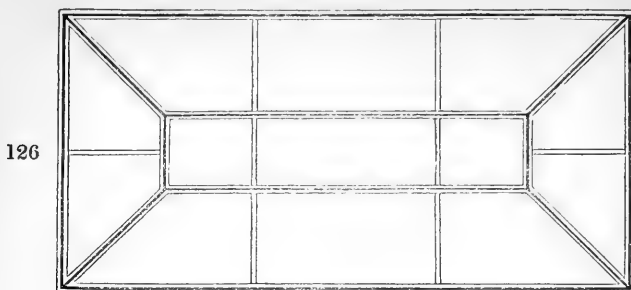
Cross Section of the Box and Cover.

parts: the stand (*fig.* 122. *a*), the box (*b*), and the glass roof, or cover (*c*). The stand is 1 ft. 10 in. in height; the box,  $8\frac{1}{2}$  in.; and the cover, 1 ft.  $7\frac{1}{2}$  in.; making the total height 4 ft. 2 in. The stand, on which the box rests, is made of mahogany, and supported on four legs, furnished with movable casters. The box contains the soil; and is made of well-seasoned St. Domingo



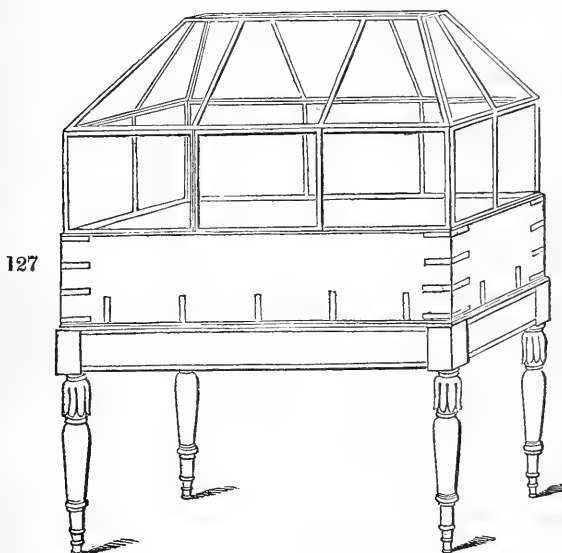
Plan of the Box, showing the two Partitions (*d d*).

mahogany, previously steeped for a fortnight in Kyan's preservative composition. Its sides are  $1\frac{1}{4}$  in. thick, mitred and dove-tailed together at the corners. The bottom of the box is of Honduras mahogany, 1 in. thick, and is formed of numerous small pieces, framed and flush-paneled, and so arranged as best to resist the yielding of the wood, in consequence of the mass of moist earth which it has to bear. To give it greater strength, two cross, or tie, pieces stretch from side to side, and are dove-tailed into the sides: they are placed at equal distances from the two ends, and thus divide the box into three compartments; but, as



*Vertical Profile, showing the Top of the Glass Cover.*

they have large open spaces at the bottom, and through their centres, they permit the moisture to percolate freely through the whole of the soil. The bottom, being properly fitted, was fixed

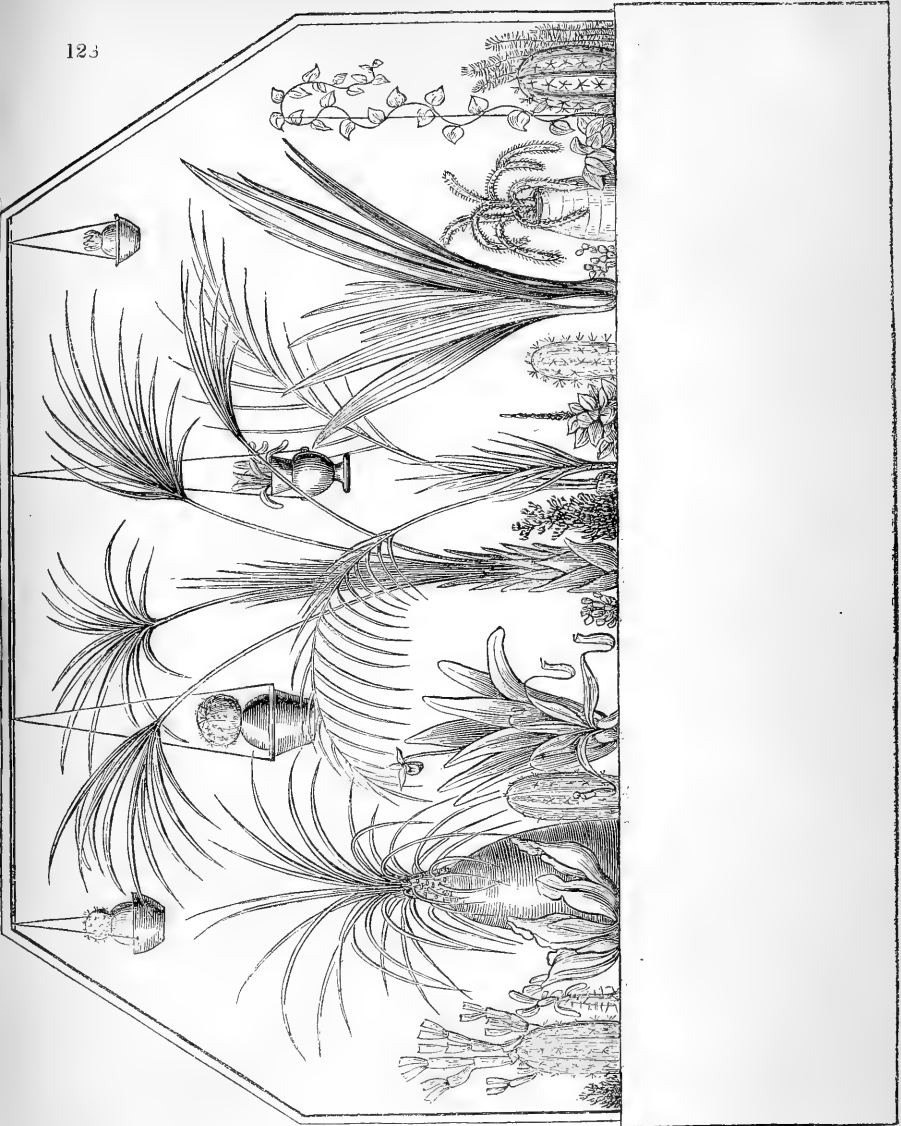


*Perspective View of the Stand, Box, and Cover, complete.\**

to the sides by brass screws; and the brass bands, at the corners and bottom, are fixed on with brass nails; no iron being used in any part. Along the upper edge of the box a groove is sunk,

\* The reader will bear in mind, that these plant stands are not intended to be used for packing plants for sending to a distance. Boxes for this purpose are differently constructed, as may be seen by consulting the *Encyclopædia of Gardening*, edit. 1835, p. 539, 540. ; and, in an early Number of this Magazine, we shall give engravings of the cases for packing plants now used by Messrs. Loddiges. — *Cond.*

123



*Longitudinal Section, showing the Plants growing in the Soil, and suspended from the Brass Rod under the Top of the Glass Case.*

to receive the lower edge of the glass roof, which rests securely in it. This groove is lined with lead; its inner lip is  $\frac{1}{16}$  of an

inch lower than the outer; and at each end is a notch,  $\frac{1}{8}$  of an inch only above the bottom of the groove, to allow the condensed moisture, which trickles down the inside of the glass, to flow back to the soil. Instead of lead, the lining of this groove should be of brass, which would prevent the galvanic action which arises from the contact of the two different metals.

It only remains to speak of the glass cover: its frame-work is made of brass, with a door on one side, made to fit close, but which can easily be opened when needed. The glass used for the cover is flattened crown-glass, except for the door, which is plate-glass. The glass panes were fitted into the frame with great care, and with a putty specially made for the purpose; this putty received afterwards three coats of paint. Along the top of the roof two brass rods extend, from which small pots containing plants may be suspended. The whole of the frame-work is well fitted, and nicely put together, so as to preclude, as far as could well be done, all interchange between the air in the case and that in the room. It was before stated, that the total height of the case is 4 ft. 2 in. Its length is 3 ft.; and its breadth,  $1\frac{1}{2}$  ft. Its form and dimensions are accurately represented in the beautiful drawings (*figs. 122—128.*) of Mr. M'Nab, which accompany this paper.

## 2. *Preparation of the Soil, and Mode of Planting.*

The soil, as prepared by Mr. M'Nab, consisted of the following ingredients, which were placed in the box in the order now to be stated. Its bottom was covered with broken potsherds, to the depth of 2 in., over which was spread 1 in. of very turfy loam; the remaining space in the box was filled with soil, composed of equal parts of peat and loam, with which a portion of rough white sand, amounting to about  $\frac{1}{20}$  part, and free from iron, was mixed. After being planted, between 3 and 4 gallons of water were freely showered over the tops of the plants from a fine-rosed watering pot; this was continued till the water ran freely from two holes made in the bottom of the box for that purpose. After draining for 24 hours, the holes were tightly fitted with corks; and the glass roof, or cover, was then put on.

The case, with its plants, was placed at the window allotted for it. The window has a southern aspect, and the morning sun strikes upon it several hours in the day. During this period, the temperature within the case was several degrees higher than that in the room; while in the absence of sunshine, or when a fire was kept up, the temperature of the room was highest. At other times, when neither sun nor fire prevailed, the temperature within and without the case rose and fell simultaneously. At no period of the winter did the temperature in the room fall to the freezing point; nor, it is believed, rise in summer higher than to about

80°. No fresh water was given during the whole period; nor was the door of the case opened, but to remove a dead leaf or plant that had damped off. Once only was the cover taken off, in order to check the *Lycopodium stoloniferum*, which had grown so luxuriantly, as to shade and injure the other plants.

### 3. List of Plants growing in the Case.

Most of the following were planted in May, 1838, and none less than nine months ago. The remarks are by Mr. M'Nab, and apply to the time of examination in May, 1839.

Botanical Names.	Continent.	Country.	Remarks.
<i>Chamaerops humilis</i>	Europe	Italy, Sicily, Spain	Increased $\frac{1}{2}$ its original size.
<i>Gentiana verna</i>	Europe	England	Flowered, but no difference in size.
<i>Adiantum Capillus Veneris</i>	Europe	England	Increased $\frac{1}{2}$ .
<i>Primula farinosa</i>	Europe	Scotland	Flowered; atmosphere rather damp for it.
scotica	Europe	Scotland	Flowered; atmosphere rather damp for it.
<i>Verbascum Myconi</i>	Europe	Scotland	Increased $\frac{1}{2}$ .
<i>Androsace villosa</i>	Europe	Scotland	Flowered; not very healthy.
<i>Chamaerops Palmetto</i>	N. America	Carolina	Increased $\frac{1}{2}$ .
<i>Dionaea Muscipula</i>	N. America	Carolina	Made $\frac{1}{2}$ .
<i>Sarracenia purpurea</i>	N. America	Carolina	Increased 4 times its original size.
<i>Epigaea repens</i>	N. America	Carolina	Increased $\frac{1}{2}$ .
<i>Testudinaria elephántipes</i>	Africa	Cape of Good Hope	Made a shoot 10 in. long.
<i>Aloe retusa</i>	Africa	Cape of Good Hope	Made $\frac{1}{2}$ , showing flower spikes.
<i>Rhododendron chrysanthum</i>	Asia	Siberia	Increased $\frac{1}{2}$ .
Chamaecistus	Europe	Austria	Increased $\frac{1}{2}$ .
<i>Cycas revoluta</i>	Asia	China	Increased $\frac{1}{2}$ .
<i>Nepenthes distillatdria</i>	Asia	Ceylon	Increased $\frac{1}{2}$ .
<i>Cypridium venustum</i>	Asia	Nepal	Increased $\frac{1}{2}$ .
insigne	Asia	Nepal	Increased $\frac{1}{2}$ .
<i>Agave geminiflora</i>	S. America	Mexico	Increased $\frac{1}{2}$ .
* <i>Goodyera discolor</i>	S. America	Mexico	No perceptible difference.
* <i>Echinocactus moltiplex</i>	S. America	Mexico	Increased $\frac{1}{2}$ .
*peruviana	S. America	Mexico	Increased $\frac{1}{2}$ .
myriacantha	S. America	Mexico	Increased $\frac{1}{2}$ .
*formosa	S. America	Mexico	Increased $\frac{1}{2}$ .
<i>Ottoni</i>	S. America	Mexico	Increased $\frac{1}{2}$ .
candida	S. America	Mexico	Increased $\frac{1}{2}$ .
<i>Epiphyllum truncatum</i>	S. America	Brazil	Increased $\frac{1}{2}$ .
<i>Cereus flagelliformis</i>	S. America	Peru	Increased $\frac{1}{2}$ .
<i>Lycopodium stoloniferum</i>	S. America	Cuba	Very luxuriant.

Those marked thus \* are growing in fancy pots, and suspended from the roof of the plant case.

### 4. Incident which suggested the Invention of the Case; with Remarks on the Mode in which a smoky Atmosphere proves injurious to Vegetation.

Having thus described the apparatus in which the plants were confined, the soil in which they have been grown, and the progress they have made under the peculiar conditions in which they have been subjected to the combined action of the several agents concerned in promoting vegetation, it is proposed next to consider how plants naturally inhabiting such different climes, and possessing such different characters, should be able, not only thus to live together, but to flourish in circumstances foreign, in many respects, to the native habits of all. Perhaps the best mode of dealing with this question will be, to compare briefly the conditions to which they are submitted in these close cases, with those to which they are naturally exposed in the free atmosphere.

Before entering on this investigation, it may not, however, be out of place to advert to the origin of the invention which has just been described. From his early youth, Mr. Ward had been attached to botanical pursuits; but, living in a situation enveloped in the smoke of numerous manufactories, he had been compelled to give up the cultivation of plants, after many unavailing trials. At length, a simple incident put him on new experiments, and led him gradually to the results we are about to detail. He had buried the chrysalis of a sphinx in some moist mould, which was contained in a wide-mouthed glass bottle, covered with a lid. In watching the bottle from day to day, he observed that the moisture, which, during the heat of the day, rose from the mould, became condensed on the inner surface of the glass, and again fell back to the mould, so as to keep it always in a state equally moist. About a week prior to the final change of the insect, a seedling fern and grass appeared on the surface of the mould. After having secured the insect, Mr. Ward set himself to watch the development of these plants in such a confined situation. He placed the bottle on the outside of the window of his study, where the plants continued to grow, and turned out to be the *Poa ánnua*, and *Nephródium Filix-más*. From this incident, so well improved by Mr. Ward, have arisen the results, both physiological and practical, which form the subject of the present communication. These results were published in the *Companion to the Botanical Magazine*, edited by Sir W. J. Hooker, in May, 1836; but the incident which gave rise to them, and the experiments to which it led, occurred seven or eight years before, that is, about eleven years from the present time (1839).

His previous want of success in growing plants in the ordinary mode, Mr. Ward attributes to the "depressing influence of the fuliginous matter with which the atmosphere in which he lives is impregnated." The real mode, however, in which such an atmosphere proves injurious to vegetation, was first shown by the experiments of Doctors Turner and Christison, which were published in the 93d number of the *Edinburgh Medical and Surgical Journal*. They ascertained that it is not simply to the diffusion of fuliginous matter through the air, but to the presence of sulphurous acid gas, generated in the combustion of coal, that the mischief is to be ascribed. When added to common air, in the proportion of  $\frac{1}{9000}$  or  $\frac{1}{10000}$  part, that gas sensibly affected the leaves of growing plants in ten or twelve hours, and killed them in forty-eight hours, or less. The effects of hydrochloric, or muriatic acid, gas were still more powerful, it being found that the tenth part of a cubic inch, in 20,000 volumes of air, manifested its action in a few hours, and entirely destroyed the plant in two days. Both these gases acted on the leaves, affecting, more or less, their colour, and withering and crisping

their texture, so that a gentle touch caused their separation from the footstalk; and both exerted this injurious operation, when present in such minute proportions as to be wholly inappreciable by the animal senses.

After having suffered much injury from these acid gases, the plants, if removed in time, will recover, but with the loss of their leaves. Hence, in vegetation carried on in a smoky atmosphere, the plants are rarely killed altogether, but merely blighted for the season. Accordingly, in spring, vegetation recommences with its accustomed luxuriance; and as in many situations there is, at that season and through the summer, a considerable diminution in the number of coal fires, there will be a proportionate decrease in the production of sulphurous acid gas; and, consequently, less injury will be done to plants during that season. In winter, too, when coal fires mostly abound, and gas is most abundantly generated, deciduous plants are protected from its noxious operation by suspension of their vegetating powers; but the leaves of evergreens, which continue to grow through that season, are constantly exposed to its action, when present in its greatest intensity. Accordingly, in many of the suburban districts around London, especially in the course of the river, where new manufactories are constantly rising up, the atmosphere is so highly charged with noxious matters, that many deciduous plants, and almost all evergreens, cease to flourish, or exhibit only a sickly vegetation.

In an interesting biographical sketch of his late lamented friend Dr. Turner, Professor Christison confirms, by subsequent experience, the opinion formerly given respecting the noxious operation of the sulphurous and muriatic gases on plants: he describes their action as so energetic, that, in the course of two days, the whole vegetation of various species of plants may be destroyed by quantities so minute as to be altogether inappreciable by the senses. On two occasions he was able to trace the identical effects of the same kind of works (the black ash manufactory) on the great scale, which his friend and himself witnessed in their researches. In one instance, the devastation committed was enormous, vegetation being for the most part miserably stunted, or blasted altogether, to a distance of fully a third of a mile from the works, in the prevailing direction of the wind. Against the evils arising from such a vitiated atmosphere, the plan of Mr. Ward provides effectual protection, as the success of his own establishment amply demonstrates.

##### *5. Condition of Plants, in regard to Water, in close Cases and in the free Atmosphere.*

In considering the conditions essential to vegetation, water may be allowed to claim the first place; for, if the vegetable

exists in a state perfectly dry, neither the seed nor the plant can exert that action on the air which is essential for its development and growth. It is "owing, therefore, to the prevention of the escape of the moisture within the cases, as Mr. Ward observes, that plants will grow in them for many months, or even years, without requiring fresh supplies of water: thus the *Pòà* and *Nephròdium*, above mentioned, grew for four years in the bottle without receiving one drop of fresh water, and would, as he believes, have grown as many more had they not perished from an accident." In vegetation in the free atmosphere, the fluids, which may be absorbed either from the soil by the roots, or from the atmosphere by the leaves, are, in great part, exhaled and dissipated; but, in the plant cases, they are condensed on the inner surface of the glass roof, and fall back to the soil from which they were raised. In this way, both the soil and atmosphere possess always sufficient humidity to carry on vegetation.

The degree of humidity which is thus maintained is not, however, suited to all plants. Those which partake largely of a cellular structure, and possess a succulent character, and especially those which have fleshy leaves, bear best the atmosphere generally existing in these cases; whilst, on the contrary, its continued humidity is unfavourable, says Mr. Ward, to the development of the flowers of most exogenous plants, except such as naturally grow in moist and shady situations. If, indeed, we call to mind the vast quantity of moisture which many plants naturally exhale in the free atmosphere, and the check which their vegetation receives if the atmosphere continue for some time both humid and still, we cannot wonder that to such plants the moist air of these cases should be unsuited, and that many of them, placed in such circumstances, should, as it is said, "damp off." But others of a different character, whether growing in the soil, or suspended from the roof, find always sufficient moisture to support a healthy vegetation. Hence the supply of water given to the soil in the first instance, being secured from waste, is successively absorbed, exhaled, and condensed within the case itself, and made to sustain over and over again the vegetation of the same plants, without suffering either the soil or the atmosphere to become, at any time, too dry to carry on that process.

#### 6. *Condition of Plants, in regard to Heat, in close Cases and in the free Atmosphere.*

The condition next to be noticed is that which relates to temperature. In the list of plants growing together in these cases are some which are natives of the tropics, others which have been brought from high latitudes, and others the growth



of our own temperate clime. Now the varying effects of climate are well known so far to modify the characters and habits of plants, as to bestow on each region its peculiar and appropriate vegetation. Even in the same latitudes, climate is so changed by elevation above the sea, as to blend the vegetation of the tropical with that of the arctic regions; the same mountain which enjoys a tropical climate at its base being found clothed, at different elevations above the sea, with the vegetation of every other clime; the plants finding, in the different altitudes at which they grow, a climate that compensates, more or less completely, for the difference of latitude. It is a great merit in the plan of Mr. Ward, that it breaks down, in a great measure, these distinctions of climate, and the peculiarities to which they give rise; and enables us not only to grow together, in the same soil and climate, plants which naturally inhabited countries the most distant from each other, and flourished only in the most opposite climes, but to pass them from one extreme of climate to another, through all the intermediate gradations, with very little trouble, and without exposing them to any great risk. Thus, in the month of June, 1833, Mr. Ward filled two cases with ferns, mosses, and grasses, and sent them out to Sydney, where they arrived in January, 1834. They were there taken out in good condition, and the cases refilled with plants of that country in the following month, the thermometer, at the time, ranging between  $90^{\circ}$  and  $100^{\circ}$  Fahr. In the passage to England, the temperature varied greatly, falling to  $20^{\circ}$  in rounding Cape Horn, and rising to  $120^{\circ}$  in crossing the Line. On arriving in the British Channel in November, the temperature was again down to  $40^{\circ}$ . During the whole voyage, of eight months, the plants in these cases received no protection either by day or by night; neither were they once watered through the whole period, and yet were taken out at London in the most healthy and vigorous condition. Other cases, filled with plants of a higher order, have been sent to Alexandria, and thence forwarded to Cairo, where, after a two months' voyage, they have been taken out of the cases in a perfectly fresh and vigorous state. Exchanges of plants have been made, by means of these cases, between the professor of botany in this university, and botanists in the Island of Cuba; and the great establishment of the Messrs. Loddiges, at Hackney, is said to have sent out or received not fewer than 200 cases filled with plants, and generally with complete success.

In the opinion of Mr. Ward, it is owing to the "quiet state of the atmosphere surrounding the plants enclosed in these cases, that they are enabled to bear the extremes of heat and cold to which they are exposed in these long voyages." In proof of the former position, he refers to the well-known ex-

periments of Fordyce and Blagden, who were able to remain, for a short time, in a close room raised to the temperature of  $212^{\circ}$ , or even  $260^{\circ}$ , Fahr.; and in support of the latter, he appeals to the experience of Mr. King, who accompanied Capt. Back in his late expedition to the arctic regions. That officer states that a difference of  $70^{\circ}$  or  $80^{\circ}$ , either from cold to heat, or from heat to cold, did not suspend his usual avocations in the open atmosphere when the air was perfectly still; but, though the temperature might be  $40^{\circ}$  higher, if it was accompanied with a stiff breeze, he did not stir from home. In like manner, Sir Edward Parry found that a degree of cold sufficient to freeze mercury could be more easily borne when the air was perfectly calm, than when, with a stiff breeze, the temperature was  $50^{\circ}$  higher. "When the cold was  $40\frac{1}{2}^{\circ}$  below freezing on the Fahr. scale," says Mr. Laing in his late *Tour in Sweden*, "it was quite practicable to prosecute the great cod-fishing in open boats in the Lafoden Isles, within the arctic circle. The calmness of the air, which accompanies this extreme cold, is a kind of natural safeguard against its severity, the abstraction of heat from our bodies being then much less rapid. Such a hard winter," he adds, "is considered here a blessing next to a good crop; for the fisherman then gets out to sea, the landsman gets in his timber out of the depths of the forest, and the inhabitants of the most pathless districts obtain their supplies of grain, potatoes, &c., at little cost of transport." (*Tour in Sweden*, p. 364.)

The powerful and rapid operation of wind in lowering temperature was shown in an experiment of Dr. Heberden, recorded in the *Philosophical Transactions* for 1826. He suspended a thermometer, previously raised to  $100^{\circ}$  Fahr., in an atmosphere at  $31^{\circ}$ , when a strong breeze prevailed, and in about half a minute the mercury fell not less than  $48^{\circ}$ ; whilst in an atmosphere at  $30^{\circ}$ , but without any perceptible wind, the fall of the mercury, previously raised, as before, to  $100^{\circ}$ , was only  $19^{\circ}$  in the same period of time. These facts, which doubtless apply to vegetable as well as to other bodies, due regard being had to differences in their conducting powers, show that degrees of cold may be borne with impunity in an atmosphere that is perfectly still, which, if accompanied with a brisk wind, would be quite intolerable. That such stillness prevails in the plant cases there can be little reason to doubt; for though considerable motion may often occur in the air within them from variations in the external heat, yet, as little or none of this air escapes, its temperature, at any given period, must be deemed pretty uniform, and cannot be rapidly reduced as it is by the frequent contacts and changes of surface which go on in the free motions of an agitated atmosphere. In an atmosphere, too, which is so still,

and in which changes of temperature proceed so slowly, tropical plants may, perhaps, bear, without injury, degrees of cold which would prove fatal if occasioned by the frigorific operation of free air in constant and rapid motion.

7. *Condition of Plants, with regard to Light, in close Cases and in the free Atmosphere.*

Of the great importance of light to vegetation Mr. Ward is fully sensible. "The success of his plan," he says, "will be in proportion to the admission of light to all parts of the growing plants. In every place," he adds, "where there is light, even in the centre of the most crowded and smoky cities, plants of almost every family may be grown" by this method. Seeds, it is well known, germinate best when buried in the soil, and entirely secluded from light; but when the young germ pushes into day, if light be still excluded, by inverting over it an opaque vessel, the plant shoots up into a long and feeble stem, is of a pale or whitish yellow colour, and possesses little odour or savour. On the contrary, if the vessel be transparent, so as to transmit light, the growth is more vigorous, the young plant puts forth buds from its stem, and soon exhibits its characteristic form and colour.

These differences in form and colour, according as plants are grown in light or in darkness, were early noticed by Ray, and afterwards by M. Bonnet, in his *Recherches sur l'Usage des Feuilles*, p. 210. In the year 1771, Dr. Irvine described still more minutely the influence which light exerts on vegetation. Plants, says he, though furnished with water, heat, and air, grow imperfectly, if placed in a dark box, and never contain any thing but a watery juice; hence the rays of light are in some way necessary to the perfect growth of vegetables; since, when deprived of this influence, they all agree in the nature and qualities of the juices they contain; nor have they that variety in colour and flavour which they had before. The most pungent vegetables become insipid, the highest-scented inodorous, and the most variegated in colour of a uniform whiteness, when secluded from light. Vegetables, too, which grow in a natural situation, readily burn when dry; but a vegetable reared in a dark box contains nothing inflammable. (*Essays on Chemical Subjects*, p. 430.) In regard to colour and smell, similar observations were made by Professor Robison on tansy (*Tanacétum vulgare*) and other plants, which, when grown in darkness, were white, and afforded no aromatic smell; but, when brought into daylight, the white foliage died down, and the stocks then produced the proper plants in their usual dress, and having all their distinguishing smells. (*Black's Chemical Lectures*, by Robison, vol. i. p. 532.)

The great influence which light thus exerts on the colour and properties of plants must be regarded as altogether local in its operation, affecting only those parts to which it has free access; and, accordingly, the green colour, and other properties to which light gives rise, may be again obliterated by the simple exclusion of that powerful agent. "Thus, if a portion of a growing fruit," says M. Senebier, "be covered with a piece of tin foil, the uncovered portion may become perfectly red, whilst the covered part exhibits only a pale or yellowish hue; or grapes, which would have acquired a violet colour under a full exposure to light, take on a greyish hue if enclosed in black paper. Those leaves, too, which may only partially cover growing fruit, and thereby intercept the sun's rays, delineate, as it were, on the fruit beneath, the limits they set to its action. (*Mém. Phys. Chimiques*, tom. iii. p. 146.) In this manner, apples or other fruits may be marked with the impressions of leaves artificially glued on them; and fruits, so marked, it is said, are often exposed for sale in the bazaars of Persia. In North America, the operation of light, in colouring the leaves of plants, is sometimes exhibited on a great scale, and in a very striking manner. Over the vast forests of that country, clouds sometimes spread and continue for many days, so as almost entirely to intercept the light of the sun. In one instance, just about the period of vernalion, the sun had not shone for twenty days, during which time the leaves of the trees had reached nearly their full size, but were of a pale or whitish colour. One forenoon the sun broke forth in full brightness; and the colour of the leaves changed so fast, that, by the middle of the afternoon, the whole forest, for many miles in length, exhibited its usual summer dress. Of this local action of light the gardener avails himself on many occasions; and by various modes of excluding this agent from particular parts of plants, so as to effect their etiolation, he is enabled so far to modify or change, not only their colour, but their more active properties, as, in some instances, to improve their natural qualities as articles of food, and, in others, to deprive them of those which might render them unsavoury or unwholesome.

The progress of coloration in an etiolated leaf, when exposed to sunshine, was observed by Senebier. The most tender parts first pass from white to yellow; the yellow then becomes deeper; next, some green spots appear on different parts, which multiply, extend, and meet, till the whole exhibits a green colour. This progressive coloration is effected exteriorly by the action of light, and is independent of the internal vegetation of the organ. (*Mém. Phys. Chim.*, tom. ii. p. 88.) The time required for producing the effect will vary with the degree of light, and the age, texture, and peculiarities of the plant. The leaves of

French beans, which sprang white out of the earth, were observed by Senebier to become green in an hour, under exposure to an ardent sun; and, when etiolated leaves were immersed in water, they became green, under exposure to sunshine in the same way as in the free atmosphere. (*Ibid.*, p. 78—91.)

The matter thus acted on by light is contained in the cells of the parenchyma: it is green in the leaves, but of different colours in other organs of the plant: it is in its nature resinous and soluble in alcohol. By De Candolle it has been named chromule, from the Greek word signifying colour. It is the cause of colour in all vegetable surfaces, is common to other parts as well as to the leaves, and exhibits different colours in the leaves at different periods of the year (*Physiologie végétale*, t. 1. p. 321.) In addition to this chromule, there is another matter in the leaves and flowers, which, when extracted by water, exhibits a red colour on the addition of acids, and a yellow or green one on the addition of alkalies. This matter, or “colourable principle,” has been named chromogen by Dr. Hope, the distinguished professor of chemistry in this university, in a memoir on the “Coloured and Colourable Matters in the Leaves and Flowers of Plants,” read to the Royal Society of Edinburgh in 1837. From numerous experiments, made on various leaves and flowers, Dr. Hope was led to the conclusion, that chromogen, or the “colourable principle,” is not an individual substance, as hitherto supposed; but that there are two distinct principles, one, which forms the red compound with acids, which he names erythrogen; and another, which affords a yellow compound with alkalies, which he calls xanthogen. These principles exist sometimes separately and sometimes together in different plants, or in different parts of the same plant. All green leaves, all white and all yellow flowers, and white fruits, contain xanthogen alone; whilst in red and blue flowers, and in the leaves of a few plants which exhibit the former of these tints, these two principles occur together. In ten flowers possessing an orange chromule, and in the corolla of twenty purple flowers, both colourable principles were also found. Other parts of flowers, as the calyx, bractææ, &c., comported themselves as the corresponding coloured chromules of the flowers do. Litmus presented the solitary example of a substance abounding largely in erythrogen, but containing no xanthogen. Light, adds Dr. Hope, was indispensable for the production of the green chromule of leaves; but not for the formation of some of the finest tints of flowers and fruits, if essential for any: differences connected, probably, with the fact, that the formation of the green colour in leaves is always accompanied, or rather preceded, by the evolution of oxygen gas; whilst, under every degree of light, flowers always deteriorate the air.

As the solar light consists of rays possessing very different powers, M. Senebier endeavoured to discover to which species of rays the coloration of the leaves of plants was to be specially ascribed. Scheele had remarked that the violet rays of the prismatic spectrum acted soonest in blackening muriate of silver, a fact confirmed by the experiments of Senebier, who extended the same views to the action of light in the coloration of plants. He caused young colourless plants to grow in different glass vessels, so constructed that the light which fell upon them should first pass through fluids of different colours, red, yellow, and violet. At the end of four or five weeks, the leaves which had been exposed to red light had a tinge of green; those in the yellow light were at first green, but afterwards became yellow; and those in violet light were quite green, and the depth of colour increased with their age. (*Mém. Phys. Chim.*, tom. ii. p. 55. et seq.) The subsequent experiments of Ritter and Wollaston have shown that these effects were produced, not by the coloured rays, but by certain invisible rays associated with them; and which exist in greatest force at and beyond the boundary of the violet extremity of the spectrum. To these rays have been assigned the names of the chemical or deoxidating rays; of their deoxidating power we shall have abundant evidence in the next section.

#### 8. *Condition of Plants, with regard to Air, in close Cases and in the free Atmosphere.*

In the last place, we have to treat of the state or condition of the air which contributes to the support of vegetation in these plant cases. Mr. Ward appears to think that the air suffers no other change than that of "expansion by heat. With every change of temperature, a corresponding change," says he, "takes place in the volume of air; and without such variation the plants would soon perish." Besides a change of volume in the way above mentioned, it is, however, certain, that the air, in these cases, must also undergo a change of composition, which gradually impairs, and would ultimately destroy, its power of supporting vegetation. Unless, therefore, fresh air be supplied to replace that which may have been injured by the vegetative process, or means be found of restoring the deteriorated portion to its former purity, vegetation cannot long continue. Though the cases in which the plants are confined may not be perfectly air-tight, yet they are made so close as to prevent that amount of change in the air which is required for healthy vegetation; and we must, therefore, seek for other means by which a wholesome state of the atmosphere may be maintained. As the mode in which this object is accomplished is somewhat perplexing, and opinions concerning it are much at variance,

we may, perhaps, be excused for going a little farther into detail on this point than we should otherwise have done.

The experiments of various chemists, from Scheele down to De Saussure, have shown that seeds do not germinate without receiving continual supplies of fresh air; and that, in the progress of their evolution, they convert the oxygen gas of such air into an equal volume of carbonic acid gas. As plants spring from seeds, it was natural to expect that, to carry on their progressive development, they would also require fresh air, and would, in like manner, convert its oxygen into carbonic acid gas. Both these facts were proved by Dr. Ingenhousz in his *Expériences sur les Végétaux*, t. ii. p. 35. 37.; by M. Senebier in his *Physiologie Végétale*, t. iii. p. 113.; and by Théodore de Saussure in the *Annales de Chimie*, t. xxiv. p. 139. M. Senebier farther maintained that the air, thus employed in vegetation, lost precisely the quantity of oxygen gas necessary to the formation of the carbonic acid gas produced, a result confirmed by the experiments of De Saussure and by those of other writers; so that, in the progressive stages of development and growth, plants, like the seeds from which they sprang, not only require a pure air, but convert a portion of its oxygen into an equal volume of carbonic acid gas.

In opposition to these results, Dr. Priestley, from certain experiments, was led to believe that plants, instead of vitiating the air by their vegetation, reverse the effects produced in it by combustion and the respiration of animals, and thus become the chief means by which the purity of the atmosphere is maintained. (*Observations on Air, abridged*, vol. iii. p. 251.) He caused plants to vegetate in vessels of air which had been previously vitiated by combustion or respiration, and, in some instances, this foul air was restored by the plants to a condition capable of again supporting those processes; but he did not ascertain the mode in which the air itself was vitiated, although he believed that light contributed to effect its subsequent purification. His great contemporary, Scheele, repeated these experiments, but could never find the foul air which he employed to be purified by growing plants, either when the vessels were placed in sunshine or in shade. For this difference in their results a sufficient reason may be found in the fact, that the foul air used by Priestley consisted, in part, of the carbonic acid gas previously produced in it by respiration or combustion; whilst, in all the experiments made on foul air by Scheele, he carefully removed this acid gas by washing the air in milk of lime before placing the plants in it (*On Air and Fire*, p. 37. 163.), a procedure, as will presently be shown, quite sufficient to defeat the object of purifying the air.

In other experiments, made on the purification of air by the

green matter which often forms on the sides of vessels filled with stagnant water, Priestley spoke with more decision regarding the agency of light; maintaining that pure air was never produced by such matter while kept in the shade, but only when exposed to light; that the water which contained most fixed air yielded pure air most abundantly in sunshine; and that, by the agency of the sun's rays, this fixed air might be entirely dissipated, leaving only a residue of pure air. If when this green matter was yielding pure air most abundantly in sunshine, the glass vessels were removed into a dark room, or the solar rays were intercepted by a covering of black wax, the process, he added, ceased entirely. (*Observations on Air*, vol. iv. p. 337.) These results were confirmed and extended by the experiments of Ingenhousz, who ascertained that the air which had been deteriorated by the growth of plants, in the shade or through the night, recovered its former purity when exposed even for an hour and a half to the agency of the morning sun. In like manner, air which had been vitiated by respiration, and in which the carbonic acid gas was suffered to remain, was soon purified by plants in sunshine, but not when they were kept in the shade. This purification, he added, was effected only by the leaves and green succulent stems, and by leaves even when detached from the stem and immersed in water. In all his experiments, carbonic acid gas seems to have been present; and he ascribes to plants the singular power of converting that gas into respirable air, when exposed to the sun; not, however, by any process of vegetation, but solely by the operation of solar light. (*Expériences sur les Végétaux*, t. i. p. 263., &c.)

In addition to these facts, M. Senebier showed that light was not only necessary in this process of purification, but that it acted independently of heat; for he has seen leaves, when confined in water charged with carbonic acid, produce oxygen gas by the agency of light in winter, when the temperature was many degrees below freezing. In every such case, however, the oxygen is derived directly from the decomposition of carbonic acid, and is always in proportion to the existing volume of that gas; but it is never furnished by the leaves themselves, independently of light. (*Physiol. Vég.*, t. iii. p. 195.) To these authors succeeded M. Théodore De Saussure, who, by numerous experiments on plants confined in close vessels, and conducted alternately in sunshine and in shade, by careful and exact analyses of the air in its different conditions, and by accurate measurements of its quantities at different periods of the experiment, has removed many apparent anomalies, and opened the way, as we think, to a consistent and satisfactory view of the subject.

In his experiments before referred to, and published in the



*Annales de Chimie*, 1797, this distinguished chemist found that when garden peas (*Pisum sativum*), which had attained to the height of between 3 in. and 4 in., were placed in a recipient of atmospheric air, inverted in a saucer filled with water, and then set aside in a room well lighted, but which did not receive the direct rays of the sun, they grew well. At the end of ten days, the volume of air was considerably diminished, its purity greatly impaired, and it still retained  $\frac{6}{100}$  of carbonic acid. Plants of *Méntha aquática* effected similar changes in the air, whilst they continued to grow in the shade: whence it is inferred that plants, like animals, continually deteriorate the air, by converting its oxygen into carbonic acid gas, when they vegetate in the shade; a result confirmed by many experiments long since made by the author, and given to the public in the years 1807 and 1811.

In prosecuting his experiments on vegetation under the direct influence of light, M. De Saussure was led, with others, to the conclusion, that, if the air which may have been deteriorated by the growth of plants in the shade be exposed for a short time to the sun's rays, it recovers its former purity. In his *Recherches Chimiques sur la Végétation*, published in 1804, he has established this position by numerous experiments on various plants, as *Méntha aquática*, *Lýthrum Salicària*, *Pinus sylvéstris genevénsis*, and *Cactus Opúntia*. These plants were confined in glass vessels of atmospheric air, and kept for 18 or 20 hours in the shade, or in perfect darkness; but, early in the morning, the vessels were taken out and exposed for 4 or 5 hours to a bright sunshine; after such exposure, the air was examined, and was then found to have suffered no change whatever, either in purity or in volume.

By other experiments, the author next proceeds to show that, though the air, when thus exposed to light, had recovered its original composition, it must, during the experiments, have undergone successive changes of deterioration and renewal. If a substance, as moistened quicklime, which strongly attracts carbonic acid, were placed in the vessel with the growing plants, the volume of air was observed to diminish, even although the apparatus were placed in sunshine: the air, too, when analysed on the fifth or sixth day of the experiment, afforded only  $\frac{16}{100}$ , or had lost five per cent of oxygen gas; whilst similar plants, confined in another vessel, but without lime, produced no change, either in the purity or volume of their atmosphere. Now, the diminution of volume, in the experiment with lime, shows that there had been an attraction, and consequently a formation of carbonic acid gas; for the lime, which produced the diminution, acted only on that gas. The experiment, it is added, shows, farther, that the formation of carbonic acid gas is necessary to vegetation, even in sunshine, and that the reason why we do not

perceive its production by the plants which vegetate without lime in common air, is, because they then decompose it in proportion as they form it with the surrounding oxygen. (*Recherches Chim.*, p. 35, 36.)

This inference, respecting the simultaneous formation and decomposition of carbonic acid, derived from experiments made with common air, is supported by others, in which an artificial atmosphere, containing about 7 per cent of carbonic acid, was employed. Plants of the same species as those before mentioned were made use of, the same periods of alternate exposure in the shade and in sunshine were observed, and the same times allotted for the duration of the experiments. The total volume of air, at the end of the experiments, had undergone little variation, but its composition was greatly changed. The carbonic acid gas which was added to the atmosphere had more or less completely disappeared, and its place was supplied by an increase of oxygen gas, so as to raise its proportion from 21 to 24 or 26 per cent. In these experiments, therefore, not only was the carbonic acid, naturally formed by the vegetation of the plants, decomposed, but the excess of that gas which was added to the atmosphere underwent the same change; and the proportion of oxygen gas was consequently increased by 5 or 6 per cent beyond that which occurred in the experiments with common air.

From the results of these experiments, we learn that plants, like seeds, require the presence of oxygen gas in the atmosphere in which they grow, and like them, also, convert a portion of it into an equal volume of carbonic acid gas. This conversion is alike effected by their growth in the shade and sunshine. In the former case, however, the presence of this acid gas may be readily detected in the residual air by the usual tests; but, in the latter, it escapes detection, because it is then decomposed, as soon as formed, by the joint agency of the plants and solar light. Under a bright sunshine, therefore, the two processes, by which carbonic acid is alternately formed and decomposed, go on simultaneously; and their necessary operation, in as far as regards the condition of the air, is that of counteracting each other. Hence, though both may be continually exercised in favourable circumstances, the effects of neither on the atmosphere can be ascertained by ordinary means; and, consequently, though, in the experiments of De Saussure with common air, the production and decomposition of carbonic acid by plants in sunshine must have been continually going on, yet, in all the analyses which he made, the air was found unchanged, either in purity or in volume; in other words, the processes of formation and decomposition of this acid gas exactly counterbalanced each other.

Of the two processes which have been now described, each

may be considered as in its nature and purpose quite distinct from the other; hence, their effects may be readily distinguished; neither do they necessarily interfere, when actually working together. The first, or deteriorating, process, in which oxygen gas is consumed, goes on at all times and in all circumstances, when vegetation is active. It requires always a suitable temperature in which to display itself; and when that temperature falls below a certain point, which is very variable in regard to different plants, the process is more or less completely suspended, again to be renewed when the temperature shall again return. This conversion of oxygen into carbonic acid is as necessary to the evolution of the seed as to the growth of the plant, and is all that is required for germination; but the plant requires something more, for, if light be excluded, vegetation proceeds imperfectly, and the plant does not then acquire its proper colour, and other active properties which it ought to have. The chief organs by which the consumption of oxygen gas is effected are the leaves, and its purpose, in great part at least, seems to be that of producing some necessary change in the sap during its transmission through those organs, on its way from the vessels of the wood to those of the inner bark, whereby it may be rendered fit for the purposes of nutrition and growth. In its nature and object, therefore, as well as in the specific change which it produces in the air, this process closely resembles the function of respiration in animals, and may thus with propriety be deemed a physiological process.

The second, or purifying, process, in which oxygen gas is evolved, differs, in all respects, from that which has just been described. It is, in a great measure, independent of temperature; at least, it proceeds in temperatures too low to support vegetation, provided light be present, an agent not required for germination, nor essential to vegetable development. The organs by which this process acts on the air are, as before, the leaves; not, however, by changing the qualities of the sap in the vessels of those organs, but by producing changes in the chromule, or colourable matter, in their cells, to which it imparts colour and other active properties. In doing this, it does not convert the oxygen gas of the air into carbonic acid; but, by decomposing that acid gas, restores to the air the identical portion of oxygen of which the former process had deprived it. The former process, carried on by the agency of the oxygen gas of the air, was essential to living action, and affected the well-being of the whole plant; that exercised by the agency of light is not necessary to life; is local, not general in its operation; and is capable of proceeding in circumstances and under conditions incompatible with living action. By withdrawing the air altogether, or depriving it of oxygen gas, vegetation soon ceases

through the whole plant; but the exclusion of light from any part of the plant affects that part only; and even the total exclusion of that agent only deprives the plant of certain properties necessary to its perfection, but not essential to its life. These differences in the processes by which oxygen gas is alternately consumed and evolved, during the vegetation of plants in sunshine, are so manifest, both in their nature and effects, as to justify the ascription of a name to the latter process distinct from that given to the former. It might, perhaps, be denominated the chemical process, in contradistinction to that named physiological.

It would contribute much, we think, to simplify our enquiries concerning vegetation, to bear in mind these distinctions: to consider the one process as accomplished by the agency of the air, and essential to the life and growth of the plant; the other, as subordinate, depending on the agency of light, and though necessary to the perfection of vegetation, yet not essential to its existence. In this manner, each process may be followed out separately, both in regard to its immediate effects and remoter consequences, without clashing with the other; and the apparently discordant and even contradictory phenomena which, on a first view, they seem to exhibit, may be reconciled, and considered, not less in theory than in fact, as conspiring together to form one harmonious and perfect whole.

Applying these views to the subject under consideration, we see no difficulty in comprehending how the same identical volume of air in the plant cases of Mr. Ward should, for so long a period, serve the purposes of vegetation, without becoming foul from within, or receiving or requiring renewal from without. The experiments of De Saussure furnish, as we have seen, examples of a similar kind; and supply, at the same time, the desired explanation. The daily depravation and subsequent purification which the air underwent in the glass vessels of that eminent chemist must be equally accomplished, under similar circumstances, in the glass cases of Mr. Ward, that is, when their plants are similarly exposed to vegetate alternately in sunshine and in shade. And as the former found the air to continue for many days together unchanged, either in purity or in volume, when so treated; so must the air, in the plant cases of the latter, preserve, under similar treatment, its original composition and purity; not, however, by continuing always the same, but by simultaneously undergoing opposite changes in sunshine, or successive changes by alternate exposure to light and shade, which mutually counterbalance each other. Thus the deterioration of the air, occasioned by vegetable growth, is counteracted by another process, necessary to the perfection of the plant; and, amidst the vicissitudes of perpetual change, the atmosphere of these cases is maintained in a state of nearly uniform composi-

tion and purity. In this way, the same air by changes of composition, like the same water by changes in its state or condition, may be made to serve over and over again the purposes of vegetation.

There is one circumstance of difference in the experiments of De Saussure, as compared with those of Mr. Ward, which it may be proper to notice. In the experiments of the former no soil was used, but only a thin stratum of water, in which the roots of the plants were immersed, covered the surface of the mercury, over which the vessels were inverted. In the cases of Mr. Ward, the plants were set in earth. Now, vegetable soil is known to deteriorate the air, by forming carbonic acid with its oxygen, in the same manner as plants do; but the acid gas, which may thus be produced, was found by De Saussure to be decomposed by the joint agency of the plants and light, like that produced by ordinary vegetation; and, consequently, the air suffered no permanent injury. Indeed, an excess of carbonic acid, not exceeding  $\frac{1}{12}$  of the atmosphere in which plants were confined, accelerated their vegetation in sunshine, by increasing the proportion of oxygen; whilst the smallest doses of this gas proved injurious to that process in the shade.

The foregoing facts demonstrate the power of light to decompose carbonic acid gas in plants. This decomposition, however, can be effected only by the concurring agency of the light and the plant; and, whilst the acid gas is thus decomposed, the plant itself acquires a tint of green; so that the evolution of oxygen gas by the plant, and the formation of its green colour, always proceed together. Now, as the chromule, which imparts colour to the leaf, is lodged in the cells of the parenchyme, it is in those cells that we must suppose the decomposition of the acid gas to be effected, and from them also the oxygen gas must proceed. The mode in which this coloration is probably accomplished may receive illustration from the facts which follow. The "colourable principle," or chromogen of Dr. Hope, is readily extracted by water, and the colourless infusion which is thus formed becomes red on the addition of an acid, and green on the addition of an alkali. If a neutral salt be dissolved in this infusion it still remains colourless; but, if this salt be decomposed by electrical agency, then the acid and alkaline ingredients, being separated, at once produce their red and green colours. Now, if we suppose the carbonic acid gas, which enters the parenchyme of the leaves, to be attracted by, and to combine with, the alkaline matter which is so abundant in those organs, it may there form a neutral salt, and whilst this neutral state continues the leaf will remain colourless; but if the chemical rays of light, acting like electricity in the example before given, decompose this carbonate, and cause the expulsion of its acid ingredient, then the alkali, becoming predominant, will produce

its usual effect on the xanthogen of the leaf, and its chromule will in consequence be rendered green. In order to maintain this green colour in the leaf, the action of light on its saline ingredients must be regarded as in continual operation; and hence its exclusion, by suspending that action, is followed by a gradual loss of colour; and, as the carbonic acid gas is no longer decomposed, the leaf at the same time ceases to afford oxygen gas. The coloration of the leaf, therefore, is not immediately due to the evolution of oxygen, nor even to the subtraction of carbonic acid, but to the predominance of alkaline matter which that subtraction of acid occasions; consequently, the verdure succeeds to the decomposition of the acid, the evidence of which is afforded by the expulsion of oxygen gas. Hence, to speak correctly, we cannot so properly say that the green leaf affords oxygen, as that it becomes green when that gas is expelled; and thus it is, that the decomposition of carbonic acid by the agency of light gives rise, at once, to the evolution of oxygen gas, and the formation of the green colour in plants.

#### *Conclusion.*

We cannot close our remarks without congratulating Mr. Ward on the occurrence of the fortunate incident which first suggested his enquiries, and on the zeal and perseverance displayed in the experiments which ultimately terminated in the construction of the apparatus which has so long engaged our attention. To himself success must be peculiarly gratifying, inasmuch as it enables him to indulge his taste in the pursuit of a favourite science, which the locality of his residence otherwise forbade him to cultivate.

It is a great advantage of his method that it may now be put in practice by others, as it was at first by himself, simply by confining a single plant in a bottle, as well as by enclosing a greater number in the more costly apparatus which has just been described. It may therefore be practised to any extent, or adapted to any scale of expense, which the individual may find it either convenient or desirable to employ. When once fitted up, the apparatus, be it either small or large, requires scarcely any farther care or attendance. No fresh watering or airing is at any time required; nor is any inconvenience experienced from dust and litter, which often render the ordinary mode of keeping plants in well-furnished apartments objectionable and troublesome. Farther, as the plants in this apparatus are shut off from all communication with the external air, no apprehension of their injuring the atmosphere, even of close rooms, can be reasonably entertained. The only condition, in regard to attendance, that claims observance, is an occasional exposure to light, perhaps for a short period only on days of

sunshine, and for a longer one when the light is more feeble. These are advantages which render the method easily practicable by persons of every class; and will enable those who are condemned to live in a smoky atmosphere to refresh their sight with specimens of healthy vegetation within their own abodes, although the district around them should exhibit only the sickly and stunted forms of vegetable existence.

The celebrated Franklin, who looked at every thing with the eye of a philosopher, and sought to turn to some useful purpose every observation which he made, in recording the reviviscence of some common flies which had made a voyage from Virginia to England in a bottle of Madeira wine, goes on to state that a plant with its flowers fades and dies if exposed to the air without having its roots plunged in a humid soil, from which it may draw moisture to supply the waste of that which it exhales, and which is continually carried off by the air. Perhaps, he adds, if it were buried in quicksilver it might preserve for a considerable time its vegetable life; and, if this be the case, it might prove a commodious method of transporting from distant countries those delicate plants which are unable to sustain the inclemency of the weather at sea.

The ingenious suggestion of the American philosopher has been happily realised in practice by Mr. Ward, in a way much more simple and efficient than that which Franklin proposed. By its means, the rarest and most delicate plants have been transported to and from the most distant countries, with little or no trouble in regard to attendance, and scarcely any risk of suffering from the inclemency of the weather at sea. He has thereby conferred on the botanist and horticulturist benefits which no researches of travellers, however successful, nor expenditure of money, however great, could have enabled them otherwise to procure. Instead of simple descriptions, or dried specimens, or fine pictures of foreign plants, they can now fix their eyes on living specimens retaining their native freshness and beauty, and possessing all their natural and characteristic properties. Already have exchanges of plants between distant countries been carried on to a great extent; and the public conservatories, as well as those of private individuals, been enriched with specimens of many rare plants, which could scarcely have reached them by any other means. Thus, under the modified conditions with regard to climate, and the renovating processes in relation to water and air, which we have attempted to illustrate, the botanist and horticulturist may be said to have entered on new and unexplored fields of vegetable research, and to have acquired the means of transporting to their own soil the varied and most delicate plants of every region of the earth.

ART. II. *On the Means of ascertaining the Degree of Humidity most suitable for the Atmosphere of Hot-houses.* By GEORGE WAILLES.

(In a Letter to Mr. D. Beaton. Published with the consent of Mr. Wailles.)

I AM very desirous that some observations should be made, in a few of the best collections in the kingdom, on the degree of humidity of the atmosphere of our hot-houses, from which some general law on the subject may be deduced. I am convinced that the successful cultivation of plants depends as much on that as on temperature. The collection under your charge is, I am aware, as varied and as celebrated as most collections; and, judging from your communications to the *Gardener's Magazine* that your wish is to combine science with practice, I shall be glad if you will assist in the object I have in view. No doubt, the chief reason why this branch of horticultural meteorology has been so little attended to is, the time and trouble required to make the observations by the ordinary mode. We go into a stove, for instance, look at the thermometer, and, if the degree of heat indicated is near the point fixed upon as the mean, we are satisfied, and think nothing of the trouble; but, were the delicate manipulation required to ascertain the dew point by Daniel's hygrometer to be gone through every time, I much fear the temperature, like the humidity, would too often be regulated by the state of our feelings at the time. I need hardly tell you that the dew point is that degree of temperature, in any place, at which moisture is deposited from the surrounding atmosphere upon any object of that particular temperature, and that it depends, of course, upon the humidity of the air. If, therefore, the air is very moist, the slightest depression of the heat of the body in it will cause dew to form; and, on the contrary, if very dry, it will require a considerable fall of temperature to produce that result. Hence it is, that the cold produced by evaporation of a liquid will be proportioned to the hygrometric state of the surrounding medium; and, by measuring that degree of cold, we readily ascertain the degree of humidity. The common thermometer is the best instrument for the purpose of showing the temperature; and we have only to keep its bulb wet with some evaporating liquid of the same temperature as the medium it is suspended in, to measure the degree of cold produced by such evaporation, and thereby to find the dew point. To facilitate the process, I have calculated and got printed the table of which I send you a copy [printed on the next page], which may be mounted on a card board, and suspended near the thermometers. Of course, two thermometers are requisite, one with a dry bulb to mark the temperature, the other with a wet one to indicate the cold produced.



Table of the Dew Point when the Temperature of the Air, in the Shade, is between 55° and 100° Fahrenheit.

Temperature.	Difference between the dry and moistened Thermometers in Degrees of Fahr.														
	1°	2°	3°	4°	5°	6°	7°	8°	9°	10°	11°	12°	13°	14°	15°
55°	53	50	48	46	43	41	39	36	34	32	29	27	25	22	20
56	54	51	49	47	44	42	40	37	35	33	30	28	26	23	21
57	55	52	50	48	45	43	41	38	36	34	31	29	27	24	22
58	56	53	51	49	46	44	42	39	37	35	32	30	28	25	23
59	57	54	52	50	47	45	43	40	38	36	33	31	29	26	24
60	58	55	53	51	48	46	44	41	39	37	34	32	30	27	25
61	59	56	54	52	49	47	45	42	40	38	35	33	31	28	26
62	60	57	55	53	50	48	46	43	41	39	36	34	32	29	27
63	61	58	56	54	51	49	47	44	42	40	37	35	33	30	28
64	62	59	57	55	52	50	48	45	43	41	38	36	34	31	29
65	63	60	58	56	53	51	49	46	44	42	39	37	35	32	30
66	64	61	59	57	54	52	50	47	45	43	40	38	36	33	31
67	65	62	60	58	55	53	51	48	46	44	41	39	37	34	32
68	66	63	61	59	56	54	52	49	47	45	42	40	38	35	33
69	67	64	62	60	57	55	53	50	48	46	43	41	39	36	34
70	68	65	63	61	58	56	54	51	49	47	44	42	40	37	35
71	69	66	64	62	59	57	55	52	50	48	45	43	41	38	36
72	70	67	65	63	60	58	56	53	51	49	46	44	42	39	37
73	71	68	66	64	61	59	57	54	52	50	47	45	43	40	38
74	72	69	67	65	62	60	58	55	53	51	48	46	44	41	39
75	73	70	68	66	63	61	59	56	54	52	49	47	45	42	40
76	74	71	69	67	64	62	60	57	55	53	50	48	46	43	41
77	75	72	70	68	65	63	61	58	56	54	51	49	47	44	42
78	76	73	71	69	66	64	62	59	57	55	52	50	48	45	43
79	77	74	72	70	67	65	63	60	58	56	53	51	49	46	44
80	78	75	73	71	68	66	64	61	59	57	54	52	50	47	45
81	79	76	74	72	69	67	65	62	60	58	55	53	51	48	46
82	80	77	75	73	70	68	66	63	61	59	56	54	52	49	47
83	81	78	76	74	71	69	67	64	62	60	57	55	53	50	48
84	82	79	77	75	72	70	68	65	63	61	58	56	54	51	49
85	83	80	78	76	73	71	69	66	64	62	59	57	55	52	50
86	84	81	79	77	74	72	70	67	65	63	60	58	56	53	51
87	85	82	80	78	75	73	71	68	66	64	61	59	57	54	52
88	86	83	81	79	76	74	72	69	67	65	62	60	58	55	53
89	87	84	82	80	77	75	73	70	68	66	63	61	59	56	54
90	88	85	83	81	78	76	74	71	69	67	64	62	60	57	55
91	89	86	84	82	79	77	75	72	70	68	65	63	61	58	56
92	90	87	85	83	80	78	76	73	71	69	66	64	62	59	57
93	91	88	86	84	81	79	77	74	72	70	67	65	63	60	58
94	92	89	87	85	82	80	78	75	73	71	68	66	64	61	59
95	93	90	88	86	83	81	79	76	74	72	69	67	65	62	60
96	94	91	89	87	84	82	80	77	75	73	70	68	66	63	61
97	95	92	90	88	85	83	81	78	76	74	71	69	67	64	62
98	96	93	91	89	86	84	82	79	77	75	72	70	68	65	63
99	97	94	92	90	87	85	83	80	78	76	73	71	69	66	64
100	98	95	93	91	88	86	84	81	79	77	74	72	70	67	65

The bulbs of both thermometers should be covered with a fold of white silk or muslin, and pure water supplied to one of them from a phial or other vessel placed near it, by a thread of floss silk acting as a siphon. The cover of the moistened bulb and the thread must be renewed occasionally.

The above table is sufficiently accurate for all practical purposes, but the true decreasing ratio is 2.33 for each degree of depression indicated by the moistened thermometer.

To find the corresponding degree of Leslie's hygrometer, multiply the number of degrees of difference between the dry and moistened thermometers by 6.

By using a common double self-registering thermometer, and, in an orchideous-house, applying the water to the spirit thermometer, you may check your under gardener as to dryness; and, on the other hand, by wetting the mercurial thermometer in the succulent-house, you may check the moisture between the observations. A very neat instrument for the purpose, having the two thermometers mounted side by side, and a glass fountain for water fixed between them (called Mason's hygrometer), is sold by Cary the optician, in the Strand; but two of the common thermometers will answer every purpose, provided only they agree accurately. In keeping a register of this sort, both the temperature and the dew point must be noted, to be of any service.

I trust these instructions will be sufficient, and I hope you will take the matter up, especially as regards the *Orchidaceæ* and *Cáctaceæ*, which appear to be the families more immediately depending upon the vaporous state of the atmosphere for their successful cultivation, of any of the plants requiring particular management. The former are my favourites. I grow a few, and, of course, look after all the information on the subject that is published. Amongst other papers that have passed under my notice is one by yourself, in the 2d vol. of *Paxton's Magazine of Botany*, relative to the rearing of young plants of this interesting tribe; and I should feel obliged if you would inform me whether you still continue that practice, and especially (as I perceive you now receive many importations at Kingsbury) whether you adopt the same mode of treatment with the newly imported specimens, or, if not, what other. As regards the latter, I confess I have not succeeded as well as I could wish, for they have too generally damped off, or rather rotted, after making a young shoot; but before it has been perfected. Any hints on this subject will be acceptable; and also on the best mode of packing them for the voyage, in which I observe by the *Gardener's Magazine* for March last and this month, the collector Mr. Harris has out has been very successful.

I am aware I am causing you some trouble, but am persuaded that the result of the hygrometric observations will be of essential service to all interested in gardening.

*Newcastle upon Tyne, July 26. 1839.*

OUR readers will find a valuable paper "On the Relations of Heat, Moisture, and Evaporation, in natural and artificial Atmospheres," by the late Mr. Tredgold, in our first volume. The recurrence to that article reminds us of a scheme which we formed at the time Mr. Tredgold sent us the paper; and we have often wished that we could meet with some wealthy individual who would carry it into execution. It is to

construct a conservatory which should regulate itself, not only in regard to heat and air, but to atmospheric moisture. The heat could be regulated with the greatest possible ease, by the simplest form of Kewley's thermometer; and a hygrometer might operate on lead pipes, distributed immediately under the roof, pierced with holes and connected with a supply of water, so as to throw down a shower of rain at pleasure, as in Messrs. Loddiges's palm-house. The kind of hygrometer might be a surface of sponge, placed on the end of a lever, which might operate on other levers, in the manner of Ruthven's press, so as ultimately to gain one pound of power, which would lift a spring valve in a cistern of water, and admit its descent by a small pipe under a piston in a cylinder. This would give a power equal to anything that could be required; or the result might even be obtained in a simpler manner. Of course the operation of the hygrometer would be, to shut up the sources of moisture; not, as might be supposed at first sight, to open them so as to supply rain. We do not say that plants in pots could be kept in this way without the attendance of a gardener, but we have no doubt whatever that a house, where all the plants were planted in the ground, might be so kept for months, without ever being entered by the gardener. It would only be necessary for him to attend to the fires in the sheds. — *Cond.*

---

ART. III. *Notes on some Suburban Villas between London and Cheshunt, made on July 24. and August 10. 1839.* By the CONDUCTOR.

THE usual road from London to Cheshunt is one of the most public in the neighbourhood of the metropolis; but, by taking Hornsey and Southgate instead of Edmonton and Enfield, the road is as quiet as in any remote district, and the scenery as rural and varied. At Hornsey there is the beautifully situated villa of Harringay, noticed in an early volume of this Magazine, for the fine effect of the New River encircling the lawn, and forming its boundary, and for some of the largest specimens of *Magnolia* in the neighbourhood of London, especially *M. macrophylla*, noticed in the *Arb. Brit.*, vol. i. p. 272., as being, in 1835, the second largest in England, 22 ft. high, and flowering freely every year. Here, also, some fine new camellias were raised from seed by Mr. Press; and the hot-houses in the kitchen-garden, and the conservatory at the house, at a considerable distance, were heated by steam from one boiler, at a period when that mode of heating was comparatively new. At Crouch End, in this neighbourhood, is Crouch Hall, the residence of G. Booth, Esq., F.H.S., which contains a magnificent architectural conservatory; and on the opposite side of the valley is Muswell Hill, lately sold, and now denuded of some of its finest old trees. The scenery from Muswell Hill to Hornsey is singularly quiet, rural, and secluded; and so little is it known to Londoners who have not their country houses in that direction, that very few persons can find their way to it, or through it when they are there, without the aid of a guide or map.

Southgate and its neighbourhood have long been celebrated for the beauty of the villas, which are generally remarkably well wooded, the trees being chiefly

the remains of an ancient oak forest. This is placed beyond all doubt, by the oaks being chiefly of the sessile-fruited kind, as at Kenwood.

*Powis Park*, or Broomfield House, as it is sometimes called, and *Culland's Grove*, once the seat of Sir W. Curtis, are worth notice for their trees. The house which stood in Culland's Grove has been lately taken down, but the fine cedars of Lebanon, red cedars, pinasters, lofty silver firs, and large deciduous cypresses and purple beeches, still remain; a proof of what one would not on first thoughts expect, that planting often affords a more durable monument than building.

*Arno's Grove*; *Mrs. Walker*.—The house is a fine square brick building, with stone facings, in a commanding situation, with a considerable breadth of lawn in front, bordered by massive woods, over which, in the centre, is seen a varied distance. Two rooms were added to the house by Sir Robert Taylor, which are interesting, as showing the taste in interior architecture prevalent in his day. The entrance hall is very large for the size of the house; it contains a fine oak staircase, and the walls and ceiling are covered with a painting in excellent preservation, bearing the name and date of "Landscape, 1723." The walk through the grounds proceeds right and left from the front of the house, and, in making a circuit of the park, borders, in the lower part of the grounds, a considerable reach of the New River. The mode in which this walk is conducted clearly shows that the place was laid out in the time of Brown. We have first, near the house, the walk of a considerable breadth proceeding through groups chiefly of foreign trees and shrubs, separated from the park by a sunk fence; next, the walk becoming narrower, enters into a thick wood, where no fence is seen; afterwards it emerges from this wood, about a third of the breadth which it is at the house, and skirts the margin of a boundary plantation, separated from the park only by a low hedge; then it touches on the canal or river; and, half the circuit being now gone through, the walk passes through the other half much in the same manner, gradually widening as it approaches the house. As episodes, or by-scenes, to this last half of the walk, there are the kitchen-garden, conservatories, a walled flower-garden, and various scenes connected with them; and to the other half there is a large flower-garden enclosed by a shrubbery, with a rockwork, basin, fountain, &c. In the artificial plantations near the house, there are many old finely grown exotic trees; and among these a greater number of *Quercus palustris* than we have seen anywhere else. A number of these trees are from 60 ft. to 80 ft. in height, with trunks from 18 in. to 3 ft. in diameter. We have noticed in the *Arboretum Britannicum*, and it cannot, we think, be too often repeated, that this is by far the hardiest and the handsomest of the American oaks, and that it also grows far faster than any other species or variety. There are three fine specimens of it in the Hackney Arboretum, under the names of *Q. palustris*, *Q. montana*, and *Q. Banisteri*, much higher than all the other American oaks there. Had there been only one specimen of this tree, our character of it might have been doubted; but there being three standing among the most complete collection of American oaks in England, what we state cannot be controverted. Before these trees were denuded of their side branches, they were of surpassing gracefulness and beauty, notwithstanding the smoky atmosphere in which they grow. There are fine trees of *Q. palustris* at Syon, one of which is figured in our *Arboretum*, and also at Strathfieldsaye; and there is a most beautiful young one in the arboretum at Woking. So little is the tree known, that two years ago Messrs. Loddiges threw away nearly a cart-load of them; and, some years before that, some waggon-loads were taken up and burned in the Leyton Nursery. (See *Arb. Brit.*, vol. iii. p. 1888.) Is it to be wondered at that nurserymen should cease to propagate many kinds of foreign trees and shrubs, when they meet with no better encouragement than this?

There are a number of fine cedars of Lebanon in Arno's Grove, immense Weymouth pines, with spreading branches, and 80 ft. high; one of these has a young oak springing up through its root, the stem of which is so completely

embraced by the wood of the pine, as to give the idea of its being united with it in the manner of a graft, which every one knows is impossible. This is one of those cases that occasionally occur, in which reason is more to be depended on than matter of fact, or what appears to be fact. There are very large Scotch pines, one with a curiously twisted trunk; silver and spruce firs; and some hemlock spruces. A plant of *Ligustrum lucidum* was 15 ft. high before it was killed down to within 6 ft. of the ground by the criterion winter. There is a fine specimen of *Platanus orientalis*, 55 ft. high, with a head 170 ft. in circumference, which, as compared with others of *P. occidentalis* in the same grounds, shows conspicuously the greatly superior beauty of the former tree. It is somewhere remarked by Dr. Lindley, that, while there are scores of the occidental plane planted in Hyde Park and the Regent's Park, there is not one to be seen of the *Platanus orientalis*, though the latter is not only a much handsomer tree than the former, but much hardier. A stranger to this subject will naturally ask what can be the reason that the handsomer and hardier tree is not preferred to the less handsome and less hardy one. The answer is, that the one tree is propagated as easily as the willow, by cuttings, while the other requires to be raised by layers, or from seed. Hence the one species abounds in the nurseries, and is cheap; and the other is comparatively scarce, and of double the price. Another reason why the occidental plane is more planted than the oriental one is, that it grows much faster. Though we have said much on the beauty of the oriental plane in our *Arboretum Britannicum*, yet we do not consider it superfluous to make these remarks, and to add to them the suggestion which we have before made in this Magazine, of heading down occidental planes, and grafting them standard high, or as high as may be convenient, with oriental ones. We wish we could see this done in Hyde Park and Kensington Gardens. Among other specimens which we noticed at Arno's Grove were, a *Crataegus orientalis* upwards of 20 ft. high, with a fine spreading head; a *Pyrus Aronia*, forming an immense bush, 12 ft. high, and 40 ft. round; and a common berberry 96 ft. round, which is covered with fruit every year. We also noticed several magnolias, and among others a good plant of *M. macrophylla*. Against the wall, near the conservatory, is a plant of *Lagerstrœmia indica*, which has stood out a number of years without any protection whatever. Here is also a tree of *Magnolia grandiflora* covering the gable end of a house at least 30 ft. high; besides a number of other conservatory wall plants, which the rapid glance that we took of the place did not permit us to note down. In the hot-house we found a fine plant of *Pasiflora Herbertiana*, covered with both flowers and fruit.

*Minchenden House*, a seat of the Duke of Buckingham's, is now on sale. We were obligingly permitted to enter the grounds from Arno's Grove, which they adjoin. A fine broad gravel walk leads some distance along the margin of the New River, and thence ascends through a shrubbery plantation to the lawn front of the house. This is a most agreeable walk from the proximity of the river, and the picturesque grouping of the trees on both sides of it. Though the place has been evidently much neglected for many years, enough remains to show that it was planted with more than common care, 40 or 50 years ago. The house is a plain brick building, in a situation equally elevated with the house in Arno's Grove, but with the view in front much more confined. The side scenery, however, consists of noble oak woods, and the distant view is so completely rural, that we do not recollect to have seen in it a single house or building. Altogether, it is a place of much natural and fortuitous beauty, but ruined by neglect, and by bad arrangements immediately in the vicinity of the house. Near the family chapel stands the famous Chandos oak, an engraving of which, with the dimensions as given by Strutt, will be found in our *Arb. Brit.*, vol. iii. p.1763. The tree continues to grow so luxuriantly, that our present estimate makes it about 80 ft. high, instead of 60 ft., which it was, when measured for Mr. Strutt about 20 years ago; and the diameter of the head we found to be 119 ft. The trunk we measured with a line, and found it 5 ft. in diameter at 4 ft. from the ground. This oak, like most of the others

in this neighbourhood, is, as we have already observed, of the species *Q. sessiliflora*. Near it there are some other fine large trees of the same kind. The shrubbery here has evidently been planted with all the kinds of foreign trees and shrubs that could be procured in the best London nurseries in the latter end of the last century; but they have been so choked with common kinds that many of them are killed, and others are so much injured as scarcely to be recognised in the thickets of common bushes. We noticed some fine trees of American ash, several species of *Acer*, *Quercus*, *Crataegus*, and *Pyrus*; an *Arbutus Andrachne* 15 ft. high, greatly injured by the late severe winter, but not killed; a number of common arbutuses of large size, not injured in the least; one of them is 30 ft. high, with the trunk, at the surface of the ground, upwards of 2 ft. in diameter. There are, a *Populus monilifera* upwards of 100 ft. high; a great number of very large Portugal laurels (one 40 ft. high) and laurustinuses; a silver cedar 75 ft. high, with a head 72 ft. in diameter; a salisburia 35 ft. high; a spruce fir 80 ft. high, with its lower branches reclining on the ground, forming a splendid cone of verdure; some large and picturesque Scotch firs from 70 ft. to 80 ft. in height; and many large rhododendrons and azaleas. Some taste, and a very moderate expense, would render this a most delightful residence.

*Southgate Lodge*.—The house at this beautiful place was built by Nash, and the grounds laid out by Repton, for Walker Gray, Esq., about the beginning of the present century; but the place is now the property of — Taylor, Esq. In 1819, when we last saw it, the grounds were in beautiful order, but they are now in a state of comparative neglect and ruin. They consist of a gently sloping bank, on which the house is placed; and opposite to this is an amphitheatre of wood in the manner of Kenwood, but more open and extensive. The lawn or park reaches from the house to the bottom, which lies between it and the opposite bank covered with wood, the bottom being formed into a beautiful lake. The wood reaches down to the water in some places, and in others is deeply penetrated by glades of turf, finely broken by scattered groups of oaks. With the exception of the tower of a church which has been lately built, and the smoke rising from a cottage in the wood, there is not the slightest indication of houses or buildings. The place, in this respect, resembles Kenwood, with the advantage of being of greater extent and having a fine piece of water, but with the disadvantage of much less inequality in the ground, and consequently not exhibiting scenery of so strongly marked a character. We have seldom seen a place more in want of a terrace in the two garden or lawn fronts of the house, in order by its horizontal lines to contrast with the sloping lines of the lawn, and form an effective foreground to it and to the wooded bank beyond. Attached to the house is a conservatory forming the segment of a circle, and of the same width as the library, the entire end of which, consisting of two bookcases, opens and folds back in such a manner as to carry in the sides of the room to the branches of the plants. On our former visit we were in the library, and saw this bookcase opened: the effect was very striking, and it would have been more so if the walk in the conservatory had been along the centre instead of along one side. The roof and front of the conservatory is now falling in pieces, which affords an opportunity of renewing it on a better plan. Beyond the conservatory its back wall is continued as a separation from the kitchen-garden, and the dead wall, though covered with creepers, being thought rather heavy, was pierced with openings in the manner of windows. In coming along the approach road, we pass a number of scattered oak trees, almost all of the species *Q. sessiliflora*, and exemplifying in a very decided manner the inferiority of this species to the *Q. pedunculata*, as a painter's tree; a fact first pointed out by the Rev. W. T. Bree, in Vol. XII. p. 534.; and in *Arb. Brit.*, vol. iii. p. 1797. Among minor remarks we may notice the circumstance of the grass of the lawn being mixed with wild thyme, which, when it is cut by the scythe, or bruised by rolling or walking over it, fills the air with fragrance. The common garden thyme, and various other fragrant species, are sown on terrace walks in Italy and Portugal,

where scarcely any grass will grow; and the effect when parties walk on these terraces backwards and forwards, especially during the evening or night, is to fill the air with the most delightful fragrance. We can state this from our own experience when forming one of an evening party at the Signor di Negro's, in Genoa, in the summer of 1819.

*South Lodge; — Webber, Esq.*—This place has been celebrated by Whately for its temple of Pan, and by George Mason for the successful imitation of the picturesque appearance of a by-lane by the Earl of Chatham. As the former author, in 1771, mentions South Lodge as in the occupation of Mr. Sharpe, it is evident that the Earl of Chatham must have left it some time before; so that this picturesque lane was probably formed nearly a century ago. As we expected, we could neither see nor learn any thing of it; and, indeed, we question much if anything at South Lodge exists as it was in the time of the Earl of Chatham, with the exception of the situation of the house and of the larger trees. The house has undergone various changes, and the temple of Pan no longer exists, nor does any one know where it stood. There is, however, a fine old Palladian bridge, like that at Wilton, but of wood, gradually undergoing decay; a large piece of water at the bottom of the park, with islands; and in the pleasure-ground a more than usually picturesque lake of upwards of an acre, with its margin and islands so admirably planted and placed, as from no point of view to give an idea of the extent or outline, and yet every where to preserve breadth of effect in looking from the walk on the water. The secret of this, as every garden artist knows, or ought to know, is to place the islands in the sinuosities, and never in the middle, as is too frequently done. The park, or demesne, here occupies an immense sloping bank, one third of the way down which is placed the house, and above it are the kitchen-garden and shrubberies. In the latter are some good plants, especially cedars, silver firs, hemlock spruces, deciduous cypresses, and American acers, all of which, unless we except two or three evergreen oaks, must have been planted since the days of Lord Chatham. Among the trees in the park we observed *Bétula papyræa*, 65 ft. high, with an immense arm from one side 36 ft. in length, and another arm from the opposite side 35 ft. in length; the diameter of the trunk, at 3 ft. from the ground, is 2 ft. 2 in. It has been grafted on a common birch, and the scion and stock seem to have accorded very well together; since they are of the same thickness at the point of union. There are some very large Cornish elms near the house; a variegated *Quercus pedunculata* 50 ft. high; a broad-leaved *Quercus Ilex* 70 ft. high, and the willow-leaved variety of the same dimensions, both standing on hillocks, which sets them off to great advantage; a silver fir 100 ft. high, with a trunk 2 ft. 10 in. in diameter; a deciduous cypress 70 ft. high, sending up numerous knobs, or knees, as they are called in America, from the roots, as at Syon; *Acer saccharinum* 40 ft. high, and various others. The park is disfigured with some round and oval clumps of 12 or 15 years' growth, which have never been thinned,—some of those "elegant forms, the oval and the circle," which, according to Sir Henry Steuart, are the most generally pleasing forms that the landscape-gardener can adopt in laying out plantations.

"If masses," says Sir Henry, "must be planted in parks, in order to get up wood for future single trees and detached groups (which, without the interposition of the transplanting, they must be), it is plain that they will continue in existence for five and twenty, or five and thirty years, before they can be cut out with proper effect. What shape, I would ask, can be adopted with such distant objects in view, more generally pleasing than that of the circle or the oval, or some modification of it?" And again: "It is to be hoped, that there is discernment enough in our present race of artists, to see the propriety of adopting or restoring those fine figures, the oval and circle, as certainly the best for temporary and large detached masses of wood." (*Planter's Guide*, 1st ed., p. 422.) It is difficult to account for the above passage in the writings of a man of undoubted taste,

except on the principle that he had before his eyes the fear of being caricatured by Sir Walter Scott, in the *Quarterly Review*. In that *Review*, No. 72., "those elegant forms the oval, the circle, and the cone," are eulogised, while an irregular outline is described as "fantastic zigzaggery, which resembles the traces left by a dog scampering through snow," &c. This part of the *Review* was, no doubt, written partly with an eye to what Dugald Stewart had hinted against carrying irregularity to an extreme, in his *Philosophical Essays*, part ii. chap. iv. p. 285. 4to ed.; but chiefly with a view to effect, to enable the reviewer to quote Shakspeare, "What! up and down, carved like an apple tart," &c., Corporal Trim's harangue, and the German baron. When Sir Henry was not under the influence of the fear of the reviewer, we find him asserting, as the principle on which the outline of plantations ought to be formed, that art should borrow from nature "every pleasing form which owes its origin to that unfailing source of variety and beauty;" and this is in conformity with the sentiments of all the best writers on landscape-gardening. "The first requisite," says Whately, speaking of the outline of a wood, "is irregularity. The true beauty of an outline consists more in breaks than in sweeps; rather in angles than in rounds; in variety, not in succession." Irregularity, indeed, is the soul of every beauty in the outline of plantations, lawns, lakes, islands, and every object in scenery in which variety and intricacy are to be considered as leading beauties. Whatever is regular or symmetrical is soon recognised and understood; and may be grand, stately, or beautiful, but seldom varied and intricate. If, therefore, there is one principle more certain than another, in modern landscape-gardening, it is, that the outlines of all plantations ought to be irregular.

The line of separation between the park and the lawn is rendered very offensive, from a circumstance apparently too trifling to be mentioned, but which, nevertheless, is in practice a matter of some importance. The separating fence is of wire, and the lower wire is so near the ground as to prevent the mower from passing his scythe under it, and thus mowing the grass as smooth for a few inches without the fence as it is within. Not having been able to do this, the grass in the line of the fence is necessarily left to grow up, and neither being cropped by the cattle without, nor cut down by the scythe from within, it has risen among the wires, and forms a kind of grass hedge, which altogether destroys the effect of invisibility, or rather inconspicuousness, which is intended to be produced by the wire fence. The sight of this fence, and the study of the piece of water in the shrubbery, are the two lessons which the gardener may learn by visiting South Lodge.

Between Enfield and Cheshunt we saw Bull's Cross, — Bowles, Esq., and Capel House, — Hooker, Esq. The former is a new place, apparently very carefully kept, and the latter is remarkable for some fine old purple beeches and red cedars. In the village of Enfield we saw some very neat hedges of *Lycium barbarum*; some arbours finely covered with this the most rapid-growing of hardy climbers; and some large sweet bays and laurustinuses, which escaped the late severe winter without the slightest injury.

*Theobald's Park; Sir Henry Meux, Bart.* — The house is a fine old English mansion, in a commanding situation, with an extensive terrace prospect in front, in consequence of which the views from the windows of the principal rooms produce an impression at once of grandeur and cheerfulness. There is a broad walk in front of the house, and a curvilinear-roofed conservatory forming part of one wing. In the grounds there is much to approve; but, as we passed very rapidly through them, and intend to visit the place again, we defer any further remarks, and merely add that we found the place in the very highest order, even to the frame ground and back sheds of the kitchen-garden, and the shady walks in the distant woods.

Were a person in search of a suburban residence to visit the places we have mentioned, and consider their effect upon his mind, he would learn to discover what constitutes cheerfulness, independently altogether of animated nature;



and he would find distant prospect occupying a large portion of the picture, in proportion to that occupied by the foreground, an essential feature.

The Gothic Cottage, W. Harrison, Esq., and the Swiss Cottage, H. B. Ker, Esq., both at Cheshunt, will form the subjects of future Articles.

*August 10. To Cheshunt, by Wheatstone, Oakhill, and Enfield.* — To the left of the new road which leads from the Edgware Road to Wheatstone, and between West End and Child's Hill, is a villa building on the summit of a hill, which, in point of architectural taste, is such as, luckily, is not often to be met with. It consists of a centre and two wings. The centre is in the Roman manner, with Grecian architraves and pediments over the windows, and the two wings terminate in towers with Gothic battlements. The towers are high in proportion to their diameter, but still not so high as the main body of the house, which is square, while the towers are round. On the centre of the roof of this main body is a piece of iron framework, which, seen from the road, has the appearance of a tent bed, with the curtains removed. We have seen nothing to compare with this building in the neighbourhood of London, and should like to know the line of life of the proprietor, and the kind of society in which he moves. Absurdities of this kind may, perhaps, sometimes do good, by rousing attention to the subject. What is grossly erroneous can be more readily detected by the mass of society, than what is perfectly correct or supremely beautiful.

*Oakhill; Sir Simon H. Clarke, Bart., F.H.S.* — We approached this place from Wheatstone, by which road the greater part of the grounds is passed through or seen, before arriving at the house; the proper approach to the mansion is, however, from the Southgate Road, from which but a small portion of the grounds is seen by a stranger, till he looks from the drawingroom windows. In short, the house stands on the top of a bank, and the entrance front is approached over a piece of table land; plantations to the right and left serving as a screen to the distant prospect, which would otherwise be seen before entering the mansion. The situation of the house is unexceptionable; but the grounds on the lawn front are laid out and planted in the commonplace manner of the past generation, and are greatly in want of reform; they are, indeed, quite unworthy of the situation. A circumstance the more to be lamented, as they might so easily be made every thing that could be desired. From the Wheatstone approach, the undulations of the ground are seen to great advantage; more particularly at one point near the lodge, where their intersections form a beautiful foreground to Little Grove, the residence of F. Cass, Esq., a villa which, like Oakhill, stands at the head of a bank. We also see from this approach Boham Lodge, the residence of C. Knott, Esq., a villa very beautifully situated, where several improvements are going forward. Still, were these three villas to be built again, there can be no doubt but that they would be very greatly improved, and that they would bear the impress of the age; which, in this country, is in nothing more remarkable, than in the progress which has been made within the last few years in villa architecture; notwithstanding the occasional occurrence of such exceptions as that mentioned in the preceding paragraph.

At Oakhill, the kitchen-garden is the most attractive feature to a gardener. We found it in the highest order in every part; and we may safely state that we never saw before such extraordinary pines and grapes. We also saw a peach pit 40 ft. long by 13 ft. wide, which was nearly filled by an elurge nectarine and a noble peach. These, when planted, were one year trained, but with the shoots cut back to the stem, so that they might almost be termed maiden plants; nevertheless, they completely filled the house in three seasons, and bore a good crop of fruit this spring, which had been some time all gathered when we saw the trees. The trees are planted within the pit, and their roots pass through the wall into a border, which is never cropped. All the vines in the different vineries are treated in the spurring-in manner, and no greater quantity of wood or leaves is allowed to be produced, than is necessary

to support the fruit. Nothing is ever planted on the borders, either within the house or without. The leaves, in consequence of their small number, and the richness of the soil, attain an enormous size and succulency: but, at the same time, they do not shade the house so much as where the vines are trained all over a trellis under the glass; nor do they require any thing like so much care and trouble as in that mode of training. In consequence of the abundance of light which is admitted within the house, we found some vines trained against a back-wall trellis, and some rising from the earth in the manner of standards, bearing large bunches to the very ground, even of muscats. Grapes are gathered here throughout the year, with the exception of three weeks about the end of March and beginning of April; and they could be gathered during these three weeks also, if the proprietor desired it. At the present time, we found one crop removed and the leaves dropping from the wood, another nearly gathered, one beginning to ripen, and one beginning to swell. Pines are cut every week in the year. We consider it unnecessary to speak here of the treatment either of the vines or pines at Oakhill, or to say any thing in favour either of the late or present gardener; the modes of treating both pines and vines having been already given by Mr. Forsyth, in different papers in our three preceding volumes. The houses are heated chiefly by hot water; though flues are still used in some of them, but with the covers kept moist by drops of water, which issue from a leaden pipe conducted over them at a foot in height, pierced at intervals with a needle so as to allow one hole to each tile, and supplied from a cistern. The sashes and rafters in the houses are chiefly framed in wood, but in the pits the rafters are of cast iron, and the styles and rails of the sashes of wood, with the bars of copper. The general width of the larger pits is 13 ft. There is a very ingenious contrivance for fastening the sashes, invented by the architect (the late Mr. Shaw), which we shall figure and describe in a future Number. The pines are grown in pits or frames; the latter generally glazed with green glass. In one of the frames we found the stumps of Providence pines, with the leaves cut off, planted deep in pots of loam, and with a very strong bottom heat, in order to force them to throw up suckers, which they were doing abundantly.

In the open garden we found excellent crops, particularly of the new Flemish pears, which were trained against the walls in the horizontal manner. Some of these pears do not bear so readily on the spurs of the old wood, as they do on the buds and spurs of one and two-years-old wood; and hence such trees chiefly exhibit fruit in a zone between the trunk and the extremity of the branches, which zone spreads wider and wider from the trunk, as the tree advances in growth; hence, unless something is done, a large and increasing space in the centre is constantly barren. To remedy this evil, Mr. Balfour, gardener to Earl Grey, adopted reverse grafting (see Vol. I. p. 71.); and other gardeners have turned back the shoots, or crossed them in different directions over the barren spots. Mr. Davis, the present gardener at Oakhill, keeps up a succession of young branches in such a manner that the fruit is equally distributed over the tree; or at least more equally than is generally to be met with. None of the fruit tree borders are cropped, and they are all very shallow on a gravelly bottom. On a border on the north side of a wall the pine strawberry is grown, and here it comes in three weeks later than in the open garden.

The late gardener Mr. Dowding, and his successor Mr. Davis, are well known in the lists of the successful competitors for prizes for fruits, published by the Horticultural and other Metropolitan Societies. There cannot be a better garden than Oakhill for young men to study forcing and the culture of fruit trees; and, by a little management, the pleasure-ground might be rendered as superior to what it now is, as the kitchen-garden and forcing-houses are to other kitchen-gardens and forcing-houses.

ART. IV. *On the injurious Effects of Kyan's Anti-Dry-Rot Solution, as regards the Destruction of vegetable Life in the Gardens at Thoresby, Nottinghamshire.* Communicated by the Right Hon. the EARL OF MANVERS.

SOME of the rafters in one of the pine and grape houses in Thoresby Park having become quite decayed by dry rot, Earl Manvers was recommended to use timber for the new rafters which had been steeped in one of Kyan's patent tanks. Accordingly, ten new rafters for the roof lights to work upon were put up in February, 1837; such rafters being first steeped in the solution, at the strength of one pound of corrosive sublimate to ten gallons of water. These rafters were in use one year before being painted, and in that time totally killed three fine vines trained to the first three rafters, and seriously injured those trained to the remaining seven rafters; so much so, indeed, as to quite kill the fruit upon them; and, in fact, such was the injurious effect of the poisonous vapour drawn from the wood, that the fruit in the remainder of the house was of a very inferior description. The pine plants standing immediately under these rafters were seriously injured, and a considerable number of them were quite destroyed; the remainder, on being placed in the fruiting pit, in a very short time put up a small weak premature fruit.

The cause of this great damage to both the vines and pine plants was, the damp vapour which arose from the heat of the house; and also from rain soakage occasionally falling upon them.

In the spring of 1838, these rafters were carefully painted four times over; but, although the injurious effects were thereby in some degree diminished, yet the plants looked unhealthy, and did not fruit properly.

At the present time, the young vines are looking yellow, and have not a single bunch of grapes upon them; and the pines under these ten rafters are weak and unhealthy, when compared with those at the other end of the house.

In 1837, twelve young vines in pots were watered with water taken from a tank in part supplied from the roof of this hot-house, and these plants were all killed in a very short time.

A trelliswork flower stand, made of deal timber that had been steeped in the solution, was placed in a small green-house in the gardens, and if this had not been taken out, every plant in the house would have been killed by the noxious vapour arising from the wood. The plants soon came round again after the removal of the trellis.

*Thoresby Park, July, 1839.*

---

ART. V. *A Proposal to name Collections of Trees and Shrubs in Public Gardens and Nurseries, under certain Circumstances, and on certain Conditions.* By the CONDUCTOR.

It is scarcely necessary to premise, that one of the causes why a greater variety of trees and shrubs is not planted by country gentlemen is, the difficulty of getting the different kinds true to their names; and the almost certainty, when a considerable collection is ordered, of receiving a number of plants of the same species or variety under different names. This is more especially the case under such genera as *Magnolia*, *Crataegus*, *Pyrus*, *Fraxinus*, *Quercus*, *Pinus*, *Pópulus*, *Bétula*, &c. Another evil which the purchasers of trees and shrubs have reason to complain of is, that the names of varieties are very frequently inserted in catalogues as if they were species; in consequence of which, a person intending to have only a few species of a genus which contains a great number might, instead of the few kinds which would have given him

a very good idea of the genus, receive only varieties of one species, which can only give him an idea of that species, and no proper idea of the general character of the genus. For example, in the genus *Crataegus*, supposing the possessor of a small pleasure-ground can afford room for only six species, and, looking over an extensive catalogue containing seventy or eighty names, he chooses *C. arbutifolia*, *C. caroliniana*, *C. cerasifera*, *C. elliptica*, *C. pyracanthifolia*, and *C. splendens*; how will he be surprised, on seeing these kinds come into leaf, to find that they are all varieties or synonymes of *Crataegus Crús-gálli*! Supposing he chooses the following six names, *C. laciniata*, *C. incisa*, *C. quercifolia*, *C. Olivèria*, *C. Celsiana*, and *C. sibirica*; he will be not less surprised at finding them all varieties of the common hawthorn, scarcely distinguishable from one another. Again, in the genus *Pinus*, at present so popular, suppose the following sorts are ordered from the nurseryman's catalogue, *P. rubra*, *P. horizontalis*, *P. rigensis*, *P. altaica*, *P. intermedia*, and *P. genevensis*; all these, and several others which figure in catalogues as distinct species, he will find nothing more than the common Scotch pine, scarcely one of them differing sufficiently from the species to make it worth cultivating. On the other hand, supposing the proprietor of a small pleasure-ground, who could only afford room for six kinds of *Crataegus*, had ordered the following kinds, *C. coccinea*, *C. pyrifolia*, *C. nigra*, *C. flava*, *C. cordata*, and *C. tanacetifolia*; or *C. mexicana*, *C. virginica*, *C. heterophylla*, *C. orientalis*, *C. apiifolia*, and *C. Douglasii*; he would in either case have a collection of plants very different from each other, very characteristic of the genus, and exhibiting a very interesting variety of forms all referable to the same type; and which would have been obtained at exactly the same price as the others. In like manner, in the case of the genus *Pinus*, had *P. pumilio*, *P. inops*, *P. Laricio*, *P. Pinea*, *P. Tæda*, and *P. Cembra* been chosen; plants very different in their appearance, and giving a fair representation of the genus *Pinus*, would have been obtained, and that for nearly the same price as the half-dozen Scotch pines above mentioned.

These observations will equally apply in the case of all genera of which there are several names given as species in the catalogues. Amid so much confusion, it is not to be wondered at that the gardener is puzzled to find out the difference between species and varieties; and that he is, in consequence of this feeling, deterred from the study of trees and shrubs, and consequently from recommending his employer to plant a collection of them, or even to introduce a greater variety into his pleasure-ground or plantations than is given by the common routine kinds. Let him, however, cease to puzzle himself by endeavours to find out specific distinctions where none exist; and let him rely upon this, that wherever a species is truly distinct, that distinction will be so obvious to the eye of a practised observer as to dispel all doubts. The distinction between varieties is equally clear: but there are certain persons, both among cultivators and practical botanists, who are continually in search of new species or varieties, and these readily seize upon the slightest marks indicating a difference, though this difference very often refers merely to one individual plant as compared with another individual plant; and we all know that differences of this kind may exist in a very striking degree, without there being any distinction between the plants sufficiently marked to constitute either a species or a variety.

The intention of the *Arboretum Britannicum* is to lessen these evils by exposing them, and by enabling those nurserymen who will take the trouble, to distinguish in their catalogues what are species and varieties, and what are synonymes; and, above all, to enable them to put the authorities to all their names. Were nurserymen to do this correctly, which they might do from the *Arboretum Britannicum*, the evil would be less enormous; because the purchaser, by means of the work mentioned, would be able to get at the history of the plant. The most desirable object, however, would be to establish the same nomenclature throughout all the nurseries in the British dominions, and more especially in all the public gardens. Were this done, a correct nomen-

clature would soon become general among every class of persons who paid any attention to trees and shrubs.

It will not be denied, we think, that, in the *Arboretum Britannicum*, we have attained as great a degree of correctness in nomenclature, as can well be done with the existing state of living specimens in this country; and we have, therefore, no hesitation in saying that it would be a great improvement in what may be called the practical nomenclature of the trees and shrubs of Britain, if that given in our work were followed. Let it be observed, that we have given no new names, but merely selected one as preferable, from the numerous synonymes already applied to the same plants; and, therefore, we are not asking the public to adopt names which we have coined, but merely to agree in all adopting the names which we have selected from those already in use.

Now, in order to promote the application of our selected names as much as lies in our power, we make the following proposals to nurserymen, and the curators of public gardens:—

1. To adopt our nomenclature for their hardy trees and shrubs.
2. To print a catalogue of them with *Arb. Brit.* as an authority to each name, and to include no name in the catalogue for which they have not a living plant.
3. To label the plants as in nurseries and botanic gardens, either with names or numbers printed on proper labels; and, if numbers, to place the same numbers before the names in the printed catalogue.
4. To agree that no additional names shall be introduced into any subsequent edition of the catalogue, so long as we live, without our sanction; or without applying for it, and waiting, for a period not longer than a fortnight, for an answer.

These conditions being agreed to in writing, we make offer, in all such cases, to examine the living plants or dried specimens, state what we consider to be their names, and prepare a proper catalogue, and superintend its printing (provided the printing be done at Mr. Spottiswoode's press, as being the most accurate in London for the spelling and accentuation of botanical names). Once in the course of every year, in July, August, or September, such additional species and varieties as may be procured by the nurserymen who accept this offer will be examined by us, and the names received with them confirmed, or the proper ones given or ascertained.

The same services, on the same conditions, are offered to nurserymen and curators of botanic gardens or public collections, in every part of Great Britain and Ireland, who will send us dried specimens, in general not less than a foot or two in length, gathered during August or September, and carefully packed, addressed to the care of Messrs. Longman and Co., carriage paid.

We do not bind ourselves to comply with these conditions after the middle of October next, except as respecting the additions to the catalogues of the nurserymen who may have adopted our names. We make this condition, because, after the middle of October, the greater part of the leaves will have dropped from the trees.

We offer these services gratuitously to commercial men and public bodies; but the possessors of private collections are too numerous for us to undertake the task for them; or, if we do so, it will be at our usual rate of a guinea an hour, or five guineas a day of eight hours, which has been our professional charge for the last thirty years, as indicated in detail in our Advertising Sheet for January, 1839.

We wish it particularly to be observed, that we will not undertake the naming of public or commercial collections of any kind, unless the parties will, immediately after our supplying the proper names, have labels of iron, wood, or brick, with numbers or names, placed against the plants; and, if numbers are preferred to names, then we require that the same numbers be given along with the names in the catalogue to be printed, as a safeguard to the public, as well as, in the case of nurserymen, to facilitate the ordering

of plants. If it can be shown that any part of the above proposal is unreasonable, we shall be glad to listen to what may be considered reason.

Such nurserymen as comply with the above conditions will have their names, and an account of their collections, conspicuously recorded in this Magazine, and they will be strongly and exclusively recommended by us to purchasers of hardy trees and shrubs.

We have been induced to make the above offer from having recently seen the confused state of the nomenclature in different public gardens and nurseries; in short, in every public and private collection in the country that we know of, without any exception whatever; and from a wish to follow up the intention of our *Arboretum Britannicum*, as expressed in the preface to that work. We hope, at least, that one or two public nurseries will accept our proposal, in order that we may be able to recommend them strongly, and with all our heart.

Our grand wish is, to effect that for hardy trees and shrubs which the Horticultural Society has so admirably done for hardy fruits, viz. the introduction of the same nomenclature in all nurseries and collections, and the diffusion everywhere of all the kinds which it is desirable to cultivate.

*Bayswater, August, 1839.*

ART. VI. *Botanical, Floricultural, and Arboricultural Notices of the Kinds of Plants newly introduced into British Gardens and Plantations, or which have been originated in them; together with additional Information respecting Plants (whether old or new) already in Cultivation: the whole intended to serve as a perpetual Supplement to the "Encyclopædia of Plants," the "Hortus Britannicus," the "Hortus Lignosus," and the "Arboretum et Fruticetum Britannicum."*

*Curtis's Botanical Magazine*; in monthly numbers, each containing seven plates; 3s. 6d. coloured, 3s. plain. Edited by Sir William Jackson Hooker, LL.D., &c.

*Edwards's Botanical Register*; in monthly numbers, new series, each containing six plates; 3s. 6d. coloured, 3s. plain. Edited by Dr. Lindley, Professor of Botany in the London University.

*Paxton's Magazine of Botany, and Register of Flowering Plants*; in monthly numbers; large 8vo; 2s. 6d. each.

*The Floral Cabinet*; in monthly numbers, 4to; 2s. 6d. each. Conducted by G. B. Knowles, Esq., M.R.C.S., F.L.S., &c., and Frederick Westcott, Esq., Honorary Secretaries of the Birmingham Botanical and Horticultural Society.

#### BERBERIDÆ.

##### 390. EPIMEDIUM

*Muschianum* Morren & Decaisne Musch's  $\frac{1}{2}$  ?  $\Delta$  | cu 1 nr W Japan 1838. C co Bot. mag. 3745.

A rather curious herbaceous plant; a native of Japan, brought to Europe by M. Von Siebold. It flowered in the Botanic Garden, Edinburgh, in the green-house; but Dr. Graham thinks that it "will, without doubt, bear cultivation in the open border." (*Bot. Mag.*, August.)

*Legumindæ.*

##### 2833. INGA

*Harrisii* Lindl. Mr. Harris's  $\frac{1}{2}$  |  $\square$  or 20 f Pk Mexico 1838. C l.p.s Bot. reg. 1839, 41.

This very elegant climbing shrub was imported from Mexico by Thomas Harris, Esq., of Kingsbury; whose splendid collection of Cacti is so well known to the botanical world. The flowers are very beautiful, and produced

in great abundance. It grows best in a temperature very "little higher" than that of a common green-house; and "it delights in a rich fresh soil, which may be formed with a mixture of good loam and peat, and about one fourth of pure sand." (*Bot. Reg.*, August.)

1251. GOMPHOLOBIUM [reg. 1839, 43.  
versicolor Lindl. changeable-coloured \* □ or 1 mr O.Y.S Swan River 1839. C s.p Bot.

A pretty species, with scarlet flowers, which become paler after expansion, introduced by Robert Mangles, Esq., of Sunning Hill. Dr. Lindley observes, under this head, that there are three species of this genus, "very much like each other, and difficult to distinguish, if, indeed, they are distinct." These are, *G. tenue*, with yellow flowers, rather long petioles, and the peduncles generally 1-flowered; *G. sparsum*, which has dark flowers, and the leaves "distinctly veiny on the upper side," while those near the bottom of the branches are larger than the others; and the present species, "*G. versicolor*, which differs from *G. tenue* in its short petioles, and subracemose dark flowers; and from *G. sparsum* in the leaflets not being all veiny, and all equal-sized." (*Bot. Reg.*, August.)

+ *Medicago clypeata* Lindl. A new medicago, a native of the north of India, of no beauty, and only curious in the shape of its capsules. (*B. M. R.*, No. 90., August.)

1268. BAUHINIA 10652 forficata Bot. Mag. 3741.

Rosaceæ § Spirææ.

*Spiræa cuneifolia* Wall., syn. *S. canescens* Don. A pretty hardy shrub, introduced by the East India Company, which has recently flowered in the Horticultural Society's Garden. It forms "an erect bush, with downy, angular, arching stems, from which proceed numerous short stiff branches, terminated by close corymbose panicles of downy white flowers." (*B. M. R.*, No. 87., August.)

*S. vacciniifolia* Don. A small shrub, introduced with the above, and having small compact panicles of white flowers. (*B. M. R.*, No. 88., August.)

+ *S. laxiflora* Lindl. "The flowers are arranged in large, loose, shaggy panicles; and the petals are moreover reflexed." It bears some resemblance to *S. fastigiata* Wall. (*B. M. R.*, No. 89., August.)

Compositæ § Asterææ.

234. CINERARIA 21440 lactea  
Synonyme: Senecio populifolius Dec. var. lacteus Lindl., Bot. Reg. 1839, 45.

A native of the Canary Isles.

Gesneriææ.

1698. GESNERIA  
Märchii Wailles. Mr. March's \* □ or 2½ o S Organ Mounts, 1839. C p.1 Bot. mag. 3744.

This is a very distinct species, producing abundance of rather pale and rather small flowers; and, as it was found on the estate of George March, Esq., in the Organ Mountains, it was named after that gentleman. "The root is a large, roundish, depressed, uneven tuber, measuring more than 3 ft. in circumference, and about 1½ in. thick." (*Bot. Mag.*, August.)

Boraginææ.

431. ONOSMA 30377 setosum Flor. Cab., No. 111.

Labiâtæ.

76. SALVIA 724 argentea Flor. Cab., No. 112.

Acanthææ.

1734. THUNBERGIA 15541 Hawtayneana Paxt. Mag. of Bot. vol. vi. p. 147.

Polygonææ.

1210. POLYGONUM 31681 amplexicaule Bot. Reg. 1839, 46.

Asarinæ.

3572. HETEROPTOPA 30075 asaroides Bot. Mag. 3746.

Orchidææ.

2553. CATTLEYA 29659 citrina Bot. Mag. 3742.

2540. ONCIDIUM 31658 pulvinatum Bot. Reg. 1839, 42.

3516. BURLINGTONIA

maculata Lindl. spotted  $\text{♀}$   $\square$  fra  $\frac{1}{2}$  my Y.n Brazil 1837. D p.r.w Bot. reg. 1839, 44.

"A sweet-scented epiphyte," with pendulous flowers, "obtained from Brazil, by the Messrs. Loddiges, with whom it flowered in May, 1838." (Bot. Reg., August.)

+ *Dendrobium bicameratum* Lindl. Brought from India by Mr. Gibson, for the Duke of Devonshire. The flowers are rather "smaller than those of *Maxillaria stapelioides*, and like them in form; their colour is a dull yellow, spotted and streaked with purple." (B. M. R., No. 85., August.)

+ *Gongora nigrita* Lindl. "This is by much the darkest of the gongoras, the appearance of the flowers being like that of the deepest puce-coloured velvet." (B. M. R., No. 86., August.)

*Phaius bicolor* Lindl. Sert. Orchid. t. 25. This very handsome Ceylon species has flowered with Messrs. Loddiges. (B. M. R., No. 91., August.)

*Goodyera rubicunda* Lindl., *Neottia rubicunda* Blume. "This plant has flowered with Messrs. Loddiges, who received it from Manilla, through Mr. Cuming." (B. M. R., No. 92., August.)

+ *Maxillaria lentiginosa* Lindl. "A plant very like *M. stapelioides*;" "imported from Brazil by the Messrs. Loddiges." (B. M. R., No. 93.)

+ *Vanda congesta* Lindl. "A small yellow and brown-flowered species from Ceylon, communicated by Messrs. Loddiges. (B. M. R., No. 94., August.)

3601. MORMO'DES 31645 pardina Flor. Cab., No. 113.

Seeds have been distributed by the Horticultural Society of no fewer than six new kinds of pines, one *Cupressus*, and three *Juniperi*, besides a number of pines, junipers, and other trees, shrubs, and plants, already in the country, but quite rare. As soon as the seeds of the new species have come up, we shall register them as introduced, and shall give engravings of the cones of the different species of *Abietinæ* and *Cupressinæ*.

## REVIEWS.

ART. I. *Abbildung und Beschreibung, &c.*; that is, *Figures of Cacti in Flower, painted and lithographed after Nature, with Descriptions, &c.* By Dr. Louis Pfeiffer, and M. Otto Director of the Royal Botanic Garden at Berlin. Part I. Imp. 4to, containing 12 pages of letterpress and six plates.

THIS work will appear in parts, each part containing five lithographic plates, and five pages of description. The figures will not be given in systematic order, but, on the contrary, it will be so arranged, that every part will contain plates of the species of different genera. The rich collection of drawings of cactuses in flower, made in the botanic gardens of Berlin, Munich, Dyke, Erfurth, and Cassel, will furnish abundance of specimens; so that there will be no danger of the work either being stopped, or appearing irregularly. The descriptions will be in French and German.

The above extract from the prospectus will give the reader an idea of this work, which is sold in Berlin at a dollar each part plain, and three dollars coloured.

The plates in Part I. are, 1. *Echinocactus Sellowiana* Link et Otto; 2. *Echinocactus centetèria* Lehm.; 3. *Mammillaria bicolor* Lehm.; 4. *Echinopsis multiplex* Zucc.; 5. *Cereus Hoókeri* Link et Otto; 6. *Opuntia Salmiana* Parm.; and *O. carassavica* Mill. These plates are most elaborately executed, and exquisitely coloured. The letterpress is copious in synonymes, descriptions, and directions for culture; and, indeed, the work, taken altogether, may be described as one of first-rate excellence. No cultivator of the *Cacti* in Europe should be without it.



**ART. II.** *The Young Farmer's Manual: showing the Practice and Principles of Agriculture, as applicable to Turnip-Land Farms in the South of England; with collateral Observations and Remarks on Agricultural Cattle, Plants, Implements, &c.* By J. Main, A.L.S. Post 8vo, pp. 274. London, 1839.

THE "Agricultural writings already before the public," Mr. Main observes, "are either small practical tracts, or voluminous codes. The first are too concise, and the last are by far too bulky and diffuse for practical readers, who only wish to know *when* and *how* any operation should be performed." Mr. Main, therefore, proposes in his "little volume," to give such a practical compendium as will meet the wishes of those "who prefer an epitome to a more laboured performance, and practical directions to scientific disquisitions." (*Pref.*, p. vii.)

The work, we are informed, contains "a detail of the actual proceedings and practice of a working farmer, who took an active and laborious part in every operation which he describes: and, although his practice be only directly applicable to a turnip-land farm in one of the southern counties of England, the general descriptions, and collateral observations, are calculated to be useful to every young farmer, wherever he may be situated, in any part of the United Kingdom.

"As the information was originally written in the form of a letter of instruction for a young friend who was about to enter into the business, the descriptions are necessarily circumstantial. Even those matters which every boy about a farm may be supposed to be acquainted with are minutely described; and this the writer has endeavoured to do in the plainest language. On all practical subjects it is scarcely possible to be too prolix: and, though it may be a fault in the composition, it cannot be objected to by pupils or inexperienced readers, more especially as reasons are given for almost every thing alluded to, or recommended to be done." (p. vi.)

The above extracts will enable the reader to form a notion of the sort of book he may expect, and we can assure him that, in perusing it, he will find it correspond with the end proposed. Indeed, we do not know any work so well adapted for communicating a practical knowledge of farming to the novice, or enabling one who had never farmed before to try his hand with success.

**ART. III.** *Goodwood, its House, Park, and Grounds, with a Catalogue raisonné of the Pictures in the Gallery of His Grace the Duke of Richmond, K.G. To which are added, an Account of the Ancient Encampment, Tumuli, and British Village, on the adjacent Downs; and a detailed Record of Goodwood Races, from their first Establishment. With six Illustrations.* By William Hayley Mason, Librarian of Goodwood. Post 8vo, pp. 215, six plates. London, 1839.

FEELING a great interest in Goodwood, on account of the numerous cedars, cork trees, and other American trees and shrubs planted there by the third Duke of Richmond, in the time of Collinson and Miller, we were most anxious to see this book; and, having been kindly favoured with a copy, we lose no time in recommending it to our readers.

After a general description of the estate and of the house, the pictures are enumerated, some of them described, and many of the portraits accompanied with historical anecdotes. These matters occupy 153 pages; after which commences a description of the park and gardens, which carries us on to p. 184.; and the remainder of the volume contains an account of the Goodwood races from their establishment in 1802 to 1838. What principally interests us is the description of the park and gardens; and we are glad to find

that Mr. Mason coincides in opinion with us, viz., that the different scenes require to be united and harmonised, as hinted at in our volume for 1829, p. 583. The third Duke of Richmond was one of the greatest planters of his time, and the interest which any person fond of trees must feel in examining the plantations at Goodwood is intense. It is singular, that of the thousand, or probably thousands, of cedars of Lebanon, planted by the Duke of Richmond in 1761, only 139 were remaining in 1837, when His Grace the present duke kindly sent us an account of them for the *Arboretum Britannicum* (see vol. iv. p. 2414.). These cedars, Collinson informs us, were raised by John Clarke, a butcher at Barnes; and he paid 79*l.* 6*s.* for them, on behalf of the Duke of Richmond. But these do not include the whole of the cedars which the duke planted; for Mr. Collinson has a second entry in his copy of *Miller's Dictionary*, viz., "October 20. 1762, I paid Mr. Clarke for another large portion of cedars for the Duke of Richmond;" and he informs us, besides, that the duke annually raised "infinite numbers of pines, firs, and cedars." Mr. Collinson adds, "the duke's father was a great planter, but the young duke much exceeds him; for he intends to clothe all the lofty naked hills above him with evergreen woods, &c." (*Arb. Brit.*, *ibid.*) We do hope that the present duke will follow up the intention of his noble ancestor; not only in planting on a large scale, but in introducing in the pleasure-grounds, and in the park near the house, all the hardy trees and shrubs that have been brought into this country since 1760, and all that have been before introduced and planted at Goodwood, but which are now lost. In short, we should like to see the collection made up to the present time; and that not only by a single plant of each species or variety, but by dozens of the more ornamental and vigorous-growing kinds, such as the thorns, the oaks, the acers, &c.; but, above all things, we should like to see the present duke as anxious to plant the deodar cedar, as his ancestor was to plant the cedar of Lebanon; and to cover the hills, or, at all events, to distribute through the park, that noble tree, the *Araucaria imbricatâ*, of which there is now abundance of plants in the country. It will, however, be of little use planting these trees, unless much more care and trouble be taken in preparing the soil, than appears to have been done in planting the cedars of Lebanon; otherwise, we cannot conceive how so large a portion of them should have been lost in less than a century. We would have every pit into which a plant is introduced prepared in the manner indicated in Vol. XIII. p. 146. par. 3.; and we would answer, in that case, for the cedars, both of Lebanon and deodar, growing at the average rate of from 18 in. to 2 ft. a year, for at least twenty years in succession. It has never yet been shown what may be done on a large scale, by preparing pits in the manner described. Would we could hope that this might be tried at Goodwood!

The house is, in many respects, a noble building, and we have done justice to some of its finest features in the volume already referred to; but the scattered mass wants a Barry or a Lamb, to produce what we may call a vertical point; a tower, which would complete the pyramid, and form a feature in the general view. It wants, also, a system of terraces and Italian gardens, to unite it with the English garden and general scenery. Few places, indeed, afford a finer opportunity for displaying terraces and Italian gardens than Goodwood; and we know of no place that would be so much improved by them.

Goodwood being a show place, we consider ourselves at liberty to make these observations, though they must be considered as merely the record of the general impressions left on our mind after two rapid visits, one in 1829, and the other in 1833. Mr. Mason's book will be of great use, as observed in the preface, to the "many visiters and strangers to whom Goodwood and its collection of works of art are at all times open."

## MISCELLANEOUS INTELLIGENCE.

ART. I. *General Notices.*

*NEGLECT of Arboriculture by the British Government.*—It is impossible to close this subject [the introduction of new species of trees], without remarking on the neglect with which it is still treated by the government. With the most ample means of every kind, with gardens and parks of which the extent and capabilities are the admiration of every one, we do not possess one common public botanic garden or arboretum for study or reference. This circumstance we cannot but consider as disreputable and disgraceful to the government and to the country; immense sums being annually expended in the department to which it properly belongs, without a thought being cast on the advancement of science. (*Captain S. E. Cook in Annals of Nat. Hist.*, vol. iii. p. 341.)

*Marder's Grafting Composition* is recommended as a substitute for grafting-wax, and is said to be at once expansive and adhesive. If so, and if it comes as cheap as grafting-wax, it will, undoubtedly, be preferable to it; because, with excessive heat, the grafting-wax, while it expands, runs off, and leaves the graft, or the wound to which it has been applied after pruning, bare. Possibly, Marder's composition may contain caoutchouc; in which case, it will, doubtless, both expand and adhere. We have received a specimen, which we shall try, both in the open air and under glass; and if any thing worthy of notice occurs, we shall lay it before our readers. — *Cond.*

*An Earthen Water-Holder.*—I send you a specimen of an earthen water-holder (*fig. 129.*) which I made three years since, and which I have found to answer its object extremely well. Many persons may be situated, like myself, where water is an object; and my mode of applying it to newly planted flowers, but more especially dahlias, saves considerable waste. The holder, or vessel, is made conical in form (of any given size), the large end being placed downwards; and it should be sunk in the ground to its neck, at a little distance from the plant. Pour in the water (at any time of the day), and it will gradually ooze (the slower the better) through three or four small openings near the bottom; thus conveying the moisture to the very root of the plant at once, without any external evaporation. By this method of application, one pint will go as far as two or three; but this is not the sole advantage, for the fibres are not drawn upwards, as is the case with surface-watering, but follow the course of the moisture to the bottom of the holder, and there soon become established beyond the influence of external drought. A garden pot is sometimes sunk in the ground, for the same object as I had in view; but my holders are more economical of water, and less unsightly to the eye. — *H. Taylor. Highgate Common, June 28. 1839.*



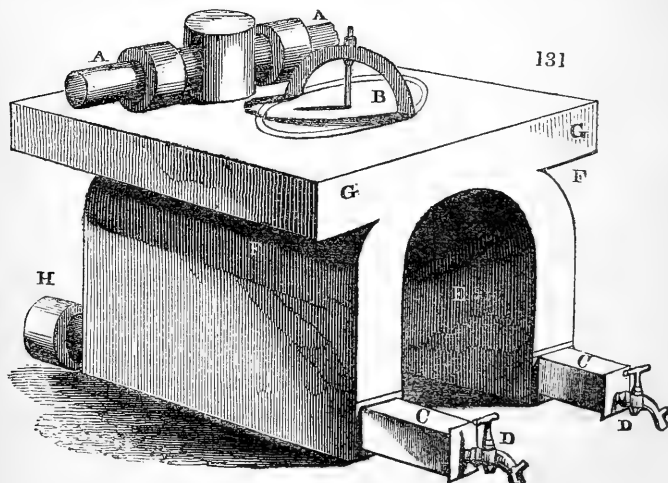
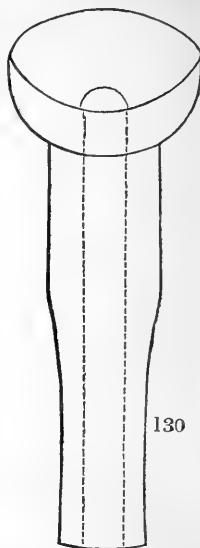
The *Dahlia-Holder*, *fig. 130.*, is used by Mr. Pratt, head gardener to W. Harrison, Esq., of Gothic Cottage, Cheshunt. It is made of any easily turned wood; such as poplar, lime, sycamore, &c.; and the stalk of the flower being thrust down the bore, it is made fast by wedging it at the lower end of the orifice. Dahlias thus supported are inserted in holes made at regular distances in a tin plate, which forms a cover to a shallow box containing water, moistened sand, or moistened moss. So treated, the dahlia will remain fresh a week, and may be sent to any distance.

— *B.*

The *essential Point in the Culture of Fruit Trees* is, that the cultivator shall have the roots completely under his control; for, unless this be the case, he will soon find, to his great mortification, that he has no control over the branches. — *J. B. Derbyshire, July, 1839.*

*Nelumbium speciosum var. rubrum.* — I observe (p. 193.) that Signor Manetti is anxious to have seeds of *Nelumbium*; and having, a few weeks since, received half a dozen of *N. speciosum* (red var.) from Dr. Wallich, I have much pleasure in dividing them with him. I may here mention that, some years ago, a seed of this species, more than sixty years old, was placed in water, as is usual in raising these plants, and vegetated in less than forty-eight hours. My friend Sir W. J. Hooker considered it an extraordinary instance of the vitality of seeds. There could be no mistake as to its age. — *N. W. G. August 13. 1839.* We have forwarded the seeds to Signor Manetti. — *Cond.*

*Williams's Boiler for heating Hot-houses* is formed of wrought iron, and conveniently contrived for being cleaned. In *fig. 131.*, A A are the flow pipes;

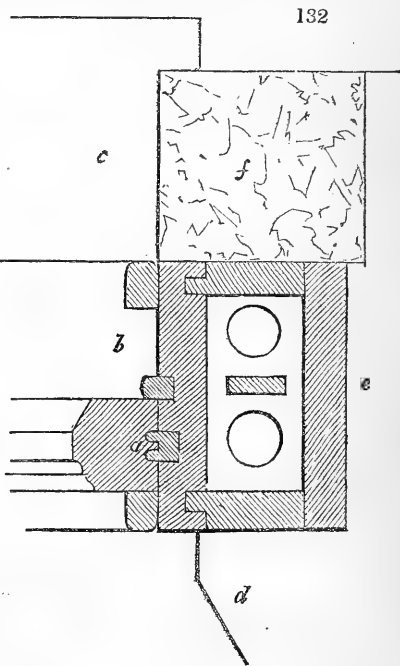


B, the man-hole; C C, apertures 3 in. square, and 9 in. long, with the cocks, D D, fixed on to the front with a movable flange, to clear out the dirt, &c., from the inside; E, the fireplace; F, the outside of the boiler, forming the side flues, where the fire passes round; G, the top of the boiler; and H, the return pipe. A model of this boiler may be seen at the office of the *Civil Engineer*;

and we have before us the testimonials of D. S. Waters, Esq., of Coventry, and of J. G. Shepherd, Esq., of Faversham, Kent, in favour of its excellent action. — *Cond.*

*The Irritability of the Stigma of the Genus Mimulus* is a fact that I do not recollect to have seen recorded: it is remarkably irritable in all the species. — *N. W. G.*

*Altering and improving an old Mansion.* — A new front requiring to be added against an old one, the walls on the ground floor which contains the principal rooms are unavoidably made of more than double the usual thickness, and advantage is taken of this to have double windows. The space between the outer and the inner windows is about 6 ft. by 4 ft., and in each window this space is occupied as a cabinet for plants in pots, which can be thrown open to the room within, or to the open air without, at pleasure. The windows in the bed-room floor of this house, being rather loose, shake a good deal with the wind; and, to prevent this, a double bead of well seasoned oak is inserted in the window case, as shown in the horizontal section *fig. 132.* at *a*, on which the style of the sash moves, and is kept firmly in its place; *b* is the situation of the outer sash, which has a similar double bead; *d* is the boxed frame for the shutters inside the room; *e* is the box for the weights; *f*, the brick forming the outside jamb of the window; and *c* the outside sill. This is one of the most effectual modes of preventing old windows from shaking which we have anywhere seen. — *Cond.*



*Paving with Wood*, which has been long practised on the Continent, has lately been tried in Oxford Street, London, and with such success, that the mode is being adopted in various other parts of the metropolis. It has long been common in gardening, in paving the floors of rustic structures, and it might be adopted with advantage in stable-yards, and in particular portions of approach roads. In executing this description of pavement, the bottom is to be made perfectly smooth and firm; the blocks of wood are set on end, in the direction of the grain, and the form of the blocks is either square, or pentagonal like the form of the cells of bees. The length of the block should not be less than 8 in. or 9 in. But whatever be the length or form of the block, it is of the utmost importance that the greatest accuracy be observed in both: for the slightest difference in the length will produce an uneven surface, and in the form of the sides, irregular interstices; in either case, exposing the edges of the blocks to be broken, or otherwise injured, by the wheels of carriages, or the feet of horses. In the case of stone pavement, this accuracy is of much less consequence; because stone is not so easily broken as wood, and, when a piece is chipped off, the weather does not make such havoc on what remains. In the case of wood, however, when the edge of the block is broken, or even bruised, the whole block absorbs and retains moisture, and very speedily wears away from the action of the feet of horses, and the wheels

of carriages. Hence, wherever wooden pavement is adopted in gardening, the gardener cannot be too rigid with the carpenter, in requiring from him the utmost exactness in the length and in the form of the blocks; and with the bricklayer or mason, in requiring the bottom, on which the blocks are to be set, to be made perfectly smooth and firm; not with mere sand or soil, but with brickwork or masonry; or, what is best of all, with a bed of concrete, 12 in. or 18 in. in thickness. Wooden paving is the best of all flooring for summer-houses and covered garden seats, on account of its being so much warmer for the feet than stone, brick, or any description of earthy material.—*Cond.*

---

## ART. II. Foreign Notices.

### NORTH AMERICA.

*NEW YORK, May, 1839.*—I send you a catalogue of my dahlias, by which you will see that we are as enthusiastic admirers of that flower in America, as you are in Europe. I dispose of about 4000 plants annually, many of which cost me from five to seven guineas each. Can you tell me anything respecting Dr. Wallich? I sent two years since, to Calcutta, two cases of American garden seeds, ordered by him and paid for in advance, for the purpose of trying how the vegetable seed of America would answer in Hindostan. The collection included every variety of cabbage, turnip, pea, bean, kidneybean, beet, onion, &c., of American growth, put in above 200 papers, so that they might be distributed far and wide. The result might have been interesting; as I have an idea, that no seeds of vegetables raised in Europe, can be as likely to answer well in India as ours; the climate here being, in summer, of an East Indian temperature. I still hope that the doctor will favour the public with the result of the experiment.—*George Thorburn.*

*New Haven, Connecticut, United States, Yale College, June 17. 1839.*—In perusing your *Encyclopædia of Gardening*, I have noticed a few things in it relative to American gardening which, in another edition, would be better altered; more particularly in your account of the New Haven Burying Ground, drawn from Stewart's over-coloured narrative, which would convey far too exalted a notion of the good taste and high keeping of the grounds; while, if I remember, no mention is made of Mount Auburn, near Boston, which may, in truth, be called the Père la Chaise of the world, except the quotation from the *North American Review*, 1831. The nine years since that time have entirely altered its character, as far as the hand of man can improve the unalterable features of nature. By the judicious selection of elegant and appropriate designs, suited to the sad character of their destination, and executed in the imperishable and unequalled granite of Quincy, an air of antiquity and venerableness has already been gained, far greater than the short period of its existence would at first seem to admit; while the skilful hand of an attentive gardener keeps all the walks in high order, and makes beauty spring and flowers bloom among the abodes of mortal decay.

I doubt if the high state of horticulture, in some departments of fruit-forcing, is as well understood in England as it exists in and about Boston and Philadelphia. Col. P. H. Perkins, a gentleman of fortune in Boston, has grape and peach houses full 1500 feet in length, heated by fire flues chiefly (the hot-water apparatus of Perkins not having worked well), and there are at this moment not less than five tons of grapes hanging from his rafters, in every stage of advancement; and with it is connected all necessary glass for forwarding cucumbers and melons at all seasons. One of his grape-houses is contrived differently from any which is described in the *Encyclopædia*, being calculated to produce two crops from different vines, at different seasons of the year; one being now ready for the table, and the other to follow

some time about January. Mr. Carbing, also, has a place of more magnificence than Col. Perkins, in the high style of finish in which every thing about his gardens and forcing-houses is executed. Here all the houses are heated by hot water, circulating beneath the marble pavements in large copper tubes. A steam engine hidden behind the high northern wall forces water into an elevated reservoir, which supplies the fountain in the centre of the garden during the almost tropical heat of our violent summers. This gentleman was the first to grow pines in North America, so far as I am informed; the inducement not being by any means so great to force that fine fruit with us as in England, our proximity to the West Indies enabling our importers of fruit to supply the market, all the summer and fall, with very fine fruit, for the trifling sum of 9d. English, which is cheaper than they can be raised under glass. — *R. Silliman, Jun.*

---

ART. III. *Domestic Notices.*

ENGLAND.

*MR. BUIST of Philadelphia* is now in Europe, visiting the principal commercial gardens of London, Edinburgh, and Paris, in search of new and rare plants, to carry back with him to his adopted country. Mr. Buist gives a most striking and gratifying account of the progress of gardening in the United States within the last six years, and more particularly in the neighbourhood of Philadelphia. We hope some correspondent, who has more leisure than Mr. Buist, will furnish us with some details. — *Cond.*

*The English Agricultural Society* held their annual meeting at Oxford, on the 16th, 17th, and 18th of July. On the first day was read a paper on wheats, by Colonel Le Couteur of Jersey, whose pamphlet on the subject has been noticed in preceding volumes. A paper, by H. Handley, Esq., M. P., was read, on the comparative advantages of wheel and swing ploughs, the preference being given to the former. The other papers were chiefly in relation to live stock. Among the machines exhibited was one called a scorcher, by Messrs. Jones and Draper of Charlbury, being a hand machine, with a fire close to the ground, and fanners to blow it; for the purpose of destroying by fire weeds, insects, &c. Several new drills and a light one-horse cart were exhibited, and the meeting seems to have gone off as well as could have been expected. (*Oxford Herald*, July 18. 1839.)

*Cottages and Cottage Gardens of Llanhenmoch.* — Colonel Sir Digby Mackworth, Bart., gives annual prizes to the cottagers of this parish, and so beneficial has been the effect, that, on a late occasion, the inspectors had the greatest difficulty in awarding the prizes, “every cottage and garden appearing so neat and clean.” (*Newport Merlin*, as quoted in *Gardener’s Gazette*, July 20.) Would that our country gentlemen generally would imitate the enlightened and benevolent Sir Digby Mackworth! The good they might, in this way, do to their poorer neighbours is immense; and such as a rich man, who has only to desire in order to obtain, can form no idea of. The ladies of a family in the country would find this kind of attention to the cottagers in their neighbourhood particularly healthful and gratifying. Every cottage and cottage garden rendered more neat and comfortable than it was before, is not only a benefit to the possessor, but an ornament to that part of the country in which it is situated. Would that gardeners everywhere would take an interest in this subject, as some of them do, and try to communicate it to their employers! There is abundance of gardeners who have excelled in growing house-plants and fruits for exhibition, and we should now wish to see them engaging in the more noble ambition of raising the character of the cottager’s garden, by encouraging the patronisers of horticultural shows to imitate the practice of Colonel Mackworth. — *Cond.*

*Rhododéndron arbóreum.* — Dr. Wallich has sent home some seeds of this

tree, which, he says, were gathered on unusually high mountains, and are, therefore, more likely to prove hardy in the climate of Britain, than seeds of the same species received from Nepal. Some of these seeds have been sent to Mr. Beaton by Mr. Wailes, whose very interesting letter on the subject of horticultural meteorology will be found in a preceding page. — *Cond.*

*Pinus Llaveana* Arb. Brit. p. 2267., and *Hort. Lig.* p. 120. — We are much gratified to find that this pine, one of the most beautiful, and, at the same time, one of the hardiest, of those which have yet been introduced from Mexico, is likely to be no longer such a rarity as it has hitherto been in British collections. We have only seen one plant of it, viz. the beautiful little tree in the Horticultural Society's garden, from which the figures in the *Arboretum* were taken, and which tree was uninjured by the winter of 1837-38. There is another tree in the Edinburgh Botanic Garden, and some plants raised from cuttings in a few English collections; but Mr. Low of the Clapton Nursery has lately raised some scores of plants, from seeds received from his collector in Mexico. — *Cond.*

*Doryánthes excelsa*. — This noble plant has lately been magnificently in flower, at Worton Lodge, the villa of George Glenny, Esq. We regret that we have not had leisure to go and see it, though, in common with other editors, we have been furnished with a free admission. A description and figure will be found in the *Gardener's Gazette* of July 13. and in the *Hort. Journ.* for August. — *Cond.*

*Cròcus lacteus* var. *lutescens* Herb. — With the kind permission of the superintendent of this garden (N. S. Hodson, Esq.), I send you two bulbs, and a few seeds of *Cròcus*, that, I believe, have hitherto been overlooked by the British botanist. Its history is as follows. In the park at Great Barton, the *Cròcus aureus* and *minimus* of the *Botanical Magazine* grow rather plentifully. About the year 1826, Mr. J. Denson, Jun., the then curator of this garden, found one growing in the park, widely differing from the above two species; he transplanted it to the old garden, where, in the removal, it was lost. Since that time I have met with it, although very sparingly, in the park; and, feeling persuaded that it had never been described, I submitted specimens last spring to several individuals; among others to the Hon. and Rev. W. Herbert, who has pronounced it to be a new variety of *C. lacteus*, and has named it *Cròcus lacteus* var. *lutescens*, and this is the variety that I now send you. Should you, or any of your botanical friends, wish for any specimens of the above three species or varieties, at any time, I shall have great pleasure in supplying them. — *H. Turner. Botanic Garden, Bury St. Edmunds, July 24. 1839.*

*Hybrids between Fúchsia fulgens and F. grandiflora*. — I fertilised the latter species with the former, and have obtained some splendid new varieties, which are now in bloom. They take much of the character of *F. fulgens* in respect to flower, foliage, and habit; being strong growers, free flowerers, and having every shoot with a terminating panicle or bunch of large handsome flowers. All who have seen these hybrids allow them to be far superior to any others that have yet been produced. To the best half dozen I have given the following names and descriptions.

*Fúchsia majestica*. Flower, including the footstalk,  $4\frac{1}{2}$  in. long; flower 2 in. across; strong-growing, broad, and fine foliage.

*F. fulgida superba*. Flowers  $3\frac{1}{2}$  in. long; very compact; foliage large, dark green; a neat grower.

*F. multiflora erecta*. Flowers 3 in. long; plant a neat grower; a very abundant flowerer, with good foliage. An extra prize was awarded for this hybrid at the North Riding Horticultural Show of July 26th, 1839.

*F. grandiflora maxima*. Flower  $5\frac{1}{2}$  in. long, and 2 in. in diameter; splendid large foliage, and the plant with an elegant habit.

*F. stylösa conspicua*. Flower  $3\frac{1}{2}$  in. long; globular.

*F. pendula terminalis*. Flower 2 in. long; dwarf habit, broad foliage, pendent, and terminating in large clusters of flowers. — *T. Colley. Hope Nurseries, Leeming Lane, Yorkshire, July 12. 1839.*



*A Collection of Seeds from Thibet and Cashmere*, sent home by Dr. Falconer, has lately been divided and distributed by the East India Company, with the usual enlightened liberality of that powerful body. — *Cond.*

SCOTLAND.

*Highland and Agricultural Society of Scotland. July 8. 1839.* — At this half-yearly general meeting, one hundred and twenty-three additional members were admitted; and among the articles presented were, a machine for bruising whins for cattle; an improved horseshoe by Mr. Gorrie; an improved soot distributor; and a snow plough for hill sides, so as to clear tracts for the pasturing of sheep. A model of a cottage was sent by Sir C. G. Stuart Men-teath, Bart. [Having also received a model from Sir Charles, to present to the Adelaide Gallery, we shall, in a future Number, give a plan and elevation of it; among other advantages, it has a contrivance applicable to heating a green-house.] Mr. Baillie of Jerviswoode presented plans and elevations of cottages built on his estate. [These we should much wish to have some account of, provided it will not interfere with the objects of the Highland Society.] Mr. Lawson, the Society's seedsman, presented the twentieth volume of his *Hortus Siccus Britannicus*, the work of a number of years, and now containing one of the most complete collections of British plants extant, only a very few of the rarer kinds being wanting. (*Scotsman*, July 13. 1839.)

ART. IV. *Queries and Answers.*

*HEDY'CHIUM* sp. — Having observed in the list of plants that were destroyed by the severe winter of 1837-8, at Bicton, the seat of Lord Rolle, three or four species of *Hedýchium* mentioned, may I be permitted, through the medium of your Magazine, to ask Mr. Glendinning, the head gardener there, for some account of their previous culture, which species they were, whether they ever bloomed; and, also, if he thinks they would succeed in a conservatory of the ordinary temperature. — *A Devonian. July 19. 1839.*

*Breeding Hybrids by reciprocal Fecundation.* — As a fact towards a reply to Henslow's 8th query (p. 432.) anent hybridism, I may state that I crossed, about four years ago, the yellow marvel of Peru with the scarlet, and, *vice versa*, the scarlet with the yellow, and the result was, that the offspring of both were undistinguishable; the flowers being of an intermediate tint, a rather dull yellowish pink. — *J. C. Kent. Chambers Court, near Upton on Severn, July 23. 1839.*

ART. V. *The London Horticultural Society and Garden.*

SEPT. 4. 1838. — *Ordinary Meeting.* The following objects were exhibited. From James Bateman, Esq., F.H.S., flowers of "the soap plant" of Peru, of which the following account was read: — "It was picked up last year by Mr. Skinner, on a sandy plain in Peru, and, from its tuberous roots producing an excellent lather when used for washing, has obtained the denomination of the 'soap plant.' It has a thick tuberous taproot, of a deep yellowish colour; and, though it had been wrapped up in paper for more than half a year in a close box, it immediately vegetated when plunged, about three months since, in a border in the open air here." It has since been described in the *Botanical Register* for 1838, Misc. No. 141., under the name of *Agave Saponaria*. From John Luscombe, Esq., of Coombe Royal, near Kingsbridge, in Devonshire, a basket of the nonsuch plum; a fine variety, raised between the green gage and Coe's seedling, and an abundant and never-failing bearer. From Mrs. Marryat, F.H.S., a fine specimen of *Musa speciosa*; flowers of *Salvia leucantha*, a little-known Mexican half-hardy herbaceous plant, with white hairy flowers, situated amongst deep rose-coloured bracts and calyxes; six varieties of the dwarf cockscomb; *Amaryllis calyprata*, a green-flowered Brazilian bulb; and La-

vátera marítima, a pretty half-hardy kind of tree mallow, inhabiting the south of Europe, and apparently lost to the gardens of this country until reintroduced by Mrs. Marryat, although cultivated in the year 1597 by Gerarde. From Mr. Joseph Kirke, F.H.S., specimens of the Washington plum, one of the finest varieties of this fruit; and the Duchess of Oldenburgh apple, a handsome autumnal variety, covered, like a plum, with a white bloom. From the garden of the Society, specimens of various flowers and fruit, among which were *Philibertia grandiflora*; *Catasctum citrinum*, a new orchidaceous plant, introduced by the Society from Mexico; and *Amphicome arguta*, a beautiful half-hardy herbaceous plant, with long tubular pink flowers, introduced from the Himalaya Mountains by Professor Royle. Among the fruits were the Acton Scot peach; the late duke cherry, a most valuable late variety, with the quality of the May duke; the nectarine plum, an excellent bearer, its only fault being that of easily losing the bloom off the fruit; and the summer St. Germain and English Caillot Rosat pears, both good bearers, ripening at a time when good pears are not plentiful.

September 18, 1838. — *Ordinary Meeting.* Read, extracts from a letter, addressed to the Vice-Secretary, by Dr. Hugh Falconer, Superintendent of the Botanical Garden of Saharunpur, and dated Cashmeer, January 24, 1838.

“ I have been gratified to find that the Himalayan seeds, sent by me, succeeded so well with the Horticultural Society.

“ As the result seems to have interested you, I may mention the mode in which the collection and package were managed. The seeds are collected generally on a march along an extensive tract of country; as a general rule, the pericarps are not detached, but the fruit and seed immediately packed up in paper; the closed paper packets, especially those containing baccate or juicy fruits, are daily exposed freely to the sun; and, to increase the heating effect of the solar rays, the packets are spread out on a black blanket, and kept so till the paper of the packets feels dry, a man being employed in turning them occasionally: the paper imbibes moisture during the night, and the process is repeated till all moisture is thoroughly dissipated. In the rains, which embrace about half the seed season in the Himalayas, the sun is not available, and the packets are daily dried before a gentle fire, till the same effect is produced; but the result is much more uncertain as regards subsequent germination. In packing up the packages for transmission to Europe, the little packets are folded up loosely in a couple of envelopes of paper; and an invariable caution is given along with them, never to let the packages get into a box or trunk, much less into the ship's hold; but to suspend them loosely from an airy corner of the cabin, free from the risk of moisture and spray.

“ On a march, where you move daily under canvass from place to place, the amount or duration of shade required for drying seeds, or their fleshy coverings, is not available, or I should certainly never torrefy the packets in the sun; all that can be said of the method is, that it speedily dries the seeds without killing them. The management on board ship appears to me to be every thing; loose wrappers, free exposure to the air in shade, and exemption from boxes, trunks, or the hold.

“ The exposure to the sun, with the augmented heating effect produced by radiation on a black blanket, is perhaps interesting with reference to the conditions mentioned by you at p. 304. of your *Introduction to Botany*, 2d edition; but the effect is probably merely a heating one, as the opacity of the paper, and the reflecting quality of the light colour, must prevent the luminous rays being transmitted to the seeds. I should certainly expect a different result in the end, with reference to germination, if the seeds were directly exposed.

“ On one occasion, I received from England a large investment of garden vegetable seeds from a London seedsman. They were packed in the thick dark brown paper which is generally used by grocers and seedsmen, and which, for the facility of folding, is usually in a somewhat damp state. The packages were nailed up in a large wooden box, with numerous folds of this paper, and the box then hermetically sealed in a tin case; it then found its way into the ship's hold. The damp paper, which, in the temperature of England, say at

50°, would have mattered little, became an important agent when the ship got into the tropics; at about 80° the damp became a hot vapour, and, when the seeds reached me, I found them all in a semipulpy and mildewed state, in fact parboiled by the steam process; and, out of a 30% investment, not a seed germinated.

“ I shall soon have the pleasure of sending you another collection, made on the hills to the westward, and in Cashmeer, where I now am.

“ I have found the *Prángos pabularia* growing in the valley.”

With reference to this communication, it was stated that by far the greater part of the seeds alluded to by Dr. Falconer were in a fresh state when they reached the Society, and presented a remarkable contrast with those which usually arrive from Calcutta and elsewhere. There can be no doubt, that the most important precaution to observe, in conveying seeds safely through a long voyage, consists in exposing them freely to the air; because, if that is attended to, the damp, which, when in combination with a high temperature, contributes so much towards destroying the germinating power of seeds, is dissipated as fast as it is formed. It was added, that, in the experience of the Vice-Secretary, no better plan was known for sending to great distances most kinds of seeds, than, after being well dried, packing them loosely in common brown paper, and enclosing them, without pressure, in small coarse canvass bags, suspended from the sides of a cabin, where they could be kept dry. The Society had tried various other methods, such as packing in sugar, and in charcoal; enclosing in tin cases, in bottles sealed up, &c.; and all such plans invariably proved unfit for the preservation of the germinating principle of seeds; especially the two last, which had long been known to be a means of destroying, rather than preserving, life, although still persevered in.

It was added, in illustration of these observations, that the most successful instance of introducing seeds of the deodar cedar, from India, occurred some years since; when a plan, similar to that now recommended for adoption, was adhered to. In the year 1831, the Honourable T. Leslie Melville, on his return to England, brought with him some cones of the deodar, thrown loosely into a drawer in his cabin; these were presented to the Society by that gentleman, and were so fresh, that nearly the whole of them germinated immediately upon being sown; and, in fact, furnished the principal part of the plants which the Society has been for some years distributing of this most valuable tree.

Oct. 2, 1838. — *Ordinary Meeting.* Read, a notice of a pine-apple, called the Moore Green seedling, of which a specimen had been received from James Taylor, Esq., F.H.S., of Moore Green, near Birmingham. It had been raised at the above place from seed of the Enville pine, which fruited late in the season in a pit, along with several other sorts, ripening likewise about the same time; from all of which Mr. Taylor states that the seedling differs in flavour. Mr. Thompson reported that the specimen weighed 2 lb. 12 oz.; was of a somewhat globular form, with a cock's-combed crown, resembling that of an Enville, when the latter assumes, as it frequently does, that shape. The pips were moderately prominent; scales acutely pointed, their apex reaching to the centre of the pips; colour bright orange; flesh considered equal in quality to that of the Enville.

There was also read a notice, by Mr. Robert Thompson, of a new variety of plum, called the Royale hâtive. The author stated that, although a purple plum, matching in point of flavour the green gage, had already been discovered in the Reine Claude Violette, yet that it had still remained an object of importance to procure new varieties of equal excellence, whose period of maturity should be different. This had now been, in one respect, attained by the discovery of the variety in question. It was received into the Society's collection from the nursery of M. Noisette of Paris, and fruited for the first time this season. It is mentioned in the *Almanach du Bon Jardinier* and in *Noisette's Manuel*, p. 494., where it is described as a large violet fruit, with a flavour resembling that of the Reine Claude Violette. It appears to be quite distinct from every other variety, except, perhaps, one called Miviam, of which scions had been received from M. Stoffels of Mechlin, and which will probably be found

synonymous, in which case the name proposed by M. Stoffels would have to be adopted.

The author described the variety in the following terms : — Fruit fully larger than that of the Reine Claude Violette, to which in appearance and flavour it has great resemblance. In form it is roundish; the few specimens examined were rather broader next the stalk, which is about half an inch in length, thick, and not inserted in a hollow. Skin purple, dotted and traced with a golden brown. Flesh yellow, slightly adhering to the stone, but parting from it when well ripened. Flavour exceedingly rich. Stone small, ovate, compressed. Shoots very downy; leaves slightly pubescent above; two characters which will always prevent its being confounded with the Reine Claude Violette, the shoots and leaves of which are smooth. It ripens about a fortnight or three weeks before the Reine Claude Violette and green gage. The Vice-Secretary stated that, although he could not say that this new variety equalled the green gage, yet it was undoubtedly one of very great excellence.

Exhibited from the garden of the Society, among a variety of flowers, some specimens of the *Polygonum amplexicaule*, a very pretty species, with crimson flowers, quite new to our gardens; it had been raised from seeds sent to the Society from Dr. Falconer of Saharanpur. Also a collection of fruit, the most remarkable of which was a new morello cherry, called Büttner's October Morello; which, to all the good qualities of the variety after which it is named, bears abundantly as a standard, on which it will hang several weeks later than the morello.

Oct. 16. 1838. — *Ordinary Meeting.* Read, the following extract from the meteorological journal kept in the Society's garden : —

	Mean Pressure.	Mean Temperature.	Max. Temp. in Shade.	Min. Temp. in Shade.	Amount of Rain; in Inches.
January	29.926	27.86°	49°	—4°	.27*
February	29.624	33.17	53	14	2.22
March	29.839	42.09	62	24	.86
April	29.786	44.06	69	16	.52
May	29.905	52.33	78	26	.92
June	29.880	59.89	83	35	3.65
	29.826	43.23			8.44

From which it appears that the mean pressure for February was remarkably low; more so than in any corresponding month for many years immediately preceding, with the exception of February, 1833.

Moreover, on comparing the mean temperature of the respective months, with the average of similar periods, deduced from observations made in the garden for a series of years, it appears that each of the above months was below the mean, in the following degree : —

January	-	- 8.44	April	-	-	- 4.70
February	-	- 8.03	May	-	-	- 4.15
March	-	- 1.47	June	-	-	- 1.23

The quantity of rain was also from 3 in. to 4 in. less than usual; so that the season, up to the end of June, had been unusually cold and dry.

The following objects were exhibited : — From Sir John Herschel, Bart., flowers of *Satyrium candidum* and *S. carneum*, two terrestrial orchidaceous plants introduced by him from the Cape of Good Hope, and brought into a flowering state in an open garden, in Hanover Terrace, Regent's Park; they were accompanied by *Cyanella lutea* and *Vioussèuxia aristata*, two bulbous plants from the same country. The appearance of the satyriums, one of which was

\* Melted snow.

new, and the other very rare, in this country, excited great attention, in consequence of the well known difficulty of cultivating the beautiful terrestrial Orchidææ of their part of the world. An enquiry was, therefore, subsequently addressed to Sir John Herschel, as to the circumstances under which such plants are naturally found, and the method pursued by him in their cultivation; to which the following reply was obligingly given.

“As regards their native habits, and the culture I should consider most in accordance therewith, and, therefore, more likely (*à priori*) to succeed in this country, the following is about the amount of my knowledge:—

“1. *Satyrium carneum* (the large-flowered pale pink species, with a close spike on a tall stem). The finest specimens grow in deep pure sand, but always among low shrubby vegetation, which affords a certain degree of shelter to them before the flower-stalk rises, and whose roots and their rejectamenta, no doubt, supply nourishment. However, I have grown them well in somewhat richer but still very sandy soil, and quite without shelter, and the largest spike I ever saw was the result. The essential condition seems to be very effectual *drainage*, as much water as the soil will retain while they are leafing, with a temperature not less than 50°, and increasing as the flower-stalk rises, while, at the same time, the supply of water must be cut off entirely, as they are especially apt to rot, if any wet gets into the inner folds of the leaves. In fact, from the moment the first sign of the flower-stalk appears, they cannot be kept too dry; and, while flowering, heat and sunshine in abundance are required; or the flower is pallid. When the flower is thoroughly withered, and the stalk dried, the heat and dryness must be still continued to ripen the tubers. I have had the soil, in which the tubers remained, heated by the sun at the surface to 140° and upwards, and as dry as mere dust; and this state of things lasts a month at least after the flowering.

“2. *Satyrium papillosum* (pink flowers, in the natural climate rich crimson). I have never found this in the sandy flats about the Cape. My roots were all taken from clay, baked by the sun nearly to the consistence of a brick, at De Koch's, a place about forty miles east of Cape Town, in the district of Hot-tentot's Holland. They were then in flower, rather past their maximum. Nevertheless, they grew well enough in the peaty sand of which my garden consisted; and to admiration in a fine black sand, enriched with vegetable matter, from the shrubby hills in the neighbourhood. Plenty of water, and moderate temperature while leafing, diminished supply of wet and increased heat as the flower rises, and total dryness with heat, when all is withered, seem to be the conditions.

“3. *Satyrium candidum* (white flower, with very long spurs, and rich orgeat-like odour. This delicious plant, when dried, leaves, stalk, and all, preserves, apparently *ad infinitum*, a rich and powerful flavour of the Tonquin bean, or sweet woodroffe, a flavour common to many flowers and dried plants; and depending, I have little doubt, on some peculiar vegetable principle, not in the nature of an essential oil, but less volatile. Its habitat at the Cape is in deep sand, in flat exposures, but so drained as never to be decidedly inundated in the wettest season, and perfectly dry in the hot months. It does not seem in this country to require much heat. It has flowered freely in boxes and pots of bog earth, exposed while leafing (only matted in very cold clear nights), and taken in doors when the flowers began to appear, and kept very dry. But I have now several flowering in the open air, under a south wall, in a rich garden mould. Like all the Cape plants, however, I presume that not only perfect dryness, but (at least for a time, at the commencement of the dormant state) increased heat, will be needed to ripen the tubers. The scent is finer here than at the Cape. Specimens of the *Satyrium candidum* are now in full flower in the open air, in spite of the bad weather and very sharp frosty nights we have had this month: a light mat, at night, has been their only defence.

“*Satyrium cucullatum* (green flower, with an intense odour of pepper; the scent here is also stronger, I think, than in the native climate). Its habitat is nearly the same as that of the *S. candidum*; and they are sometimes (not

commonly) found mixed. If anything, it delights in moister sand; it flowers rather earlier; I find here that they continue to demand a little water, even while in flower. My specimens, however, are few and sickly.

"5. *Satyrium chryso-stachyum*. It failed to flower here this year, though in soil brought from the Cape (fine black sand, rich in vegetable particles), as I apprehend, from inattention to watering the roots. They frequent very moist places, even swamps (i. e. in the wet season), though perfectly dry at the end of the hot months, and seem to require moisture so long as the flower continues, as well as increased heat. However, when dormant, perfect siccidity is requisite, no doubt, for these as for the rest.

"6. *Disa graminifolia* (*Herschelia cœlestis* Lindl.). It is of delicate management. Even at the Cape, I could hardly get it to bear transporting from the bulrushy sand, where it luxuriates, among an infinity of harsh sour grasses, and rush-like vegetation, about 18 in. or 2 ft. high. Yet I have had one flower-stalk from it this summer. It is a very beautiful and singular-looking flower. It seems to pine for want of its natural companions; and, except in soil taken from such localities, will probably not thrive.

"7. *Disa grandiflora*. It grows on or near the summit of the Table Mountain, where the temperature is occasionally  $31\frac{1}{2}^{\circ}$ , and occasionally also  $96\frac{1}{2}^{\circ}$  (these were the minimum and maximum of a self-registering thermometer I left there for three years). Its habitat is on the margin of pools of standing water, the drainage of the boggy slopes of the mountain, wherein its roots are immersed. These are dry, or nearly so, in summer. In such localities, it is, of course, frequently involved in the dense mist of the clouds, which, even in the hottest months, often cover the whole summit of the mountain, for a week or a fortnight uninterruptedly. It languished for two years by a pond in my garden, but would, I think, have grown accustomed to the change. I presume a moderately warm, habitually damp, atmosphere would suit it."

---

#### ART. VI. Obituary.

DIED, July 24., in the prime of life, *William Christy, Esq., Jun., F.L.S.*, of Clapham Road, Stockwell. Mr. Christy was a scientific botanist, and had a considerable botanical library and herbarium, which, foreseeing his early death, from the nature of his disease, he presented to the Botanical Society of Edinburgh above a year ago (see p. 262.). Mr. Christy was naturally of a mild and amiable disposition. He was well aware for many months that he was labouring under an incurable malady, which he bore with the most philosophic and Christian resignation, and he died at last without suffering any pain, and, we may truly say, beloved and respected by all who knew him. The following note received by us from Mr. Christy, more than a year before his death, may be useful in teaching to others that resignation of which he himself showed so remarkable an example.

"My dear Sir, I am obliged by your last kind note. After I sent mine I was so much worse, that I began taking leave of my family, and the absent members were summoned; however, thank God, I have since rallied, and do not now anticipate quite so early a termination to my illness; although ultimate recovery is, I believe, quite hopeless. With regard to your kind offer of a visit, I am sorry to decline it; but I have even been obliged to refuse those of some near relatives. At times, indeed, I can see no one, and even when tolerably well am obliged to be kept very quiet. Should any thing happen to me, you will receive intimation; and I should feel obliged by your just noticing it in the shortest way possible in the next *Gardener's Magazine*, as it may serve to convey the news to some of my horticultural correspondents, who might not otherwise hear of it. Once more, with kind regards to Mrs. Loudon, believe me, my dear Sir, yours sincerely, — *W. Christy, Clapham Road, Thursday.*

---

THE  
GARDENER'S MAGAZINE,

OCTOBER, 1839.

---

ORIGINAL COMMUNICATIONS.

ART. I. *An Account of the preparatory Operations made in the Birmingham Botanic Garden previously to planting the Arboretum there; with the Dimensions which some of the Trees have attained in Seven Years.* By D. CAMERON, Curator there.

AGREEABLY to your request (see p. 450.), I now send a short account of the preparation made before planting for the arboretum in this garden, and the height of a few of the trees.

The whole of the ground was in pasture when we commenced operations, in the spring of 1831. The soil throughout the whole of the garden is of a light sandy nature, upon a subsoil chiefly of a coarse sand mixed with gravel, about from 20 in. to 24 in. under the surface. In a few small spots the subsoil is inclined to clay, and in others to white sand. The bottom is very dry in the upper portion of the garden, but wet and springy in several portions of the lower grounds.

The whole of the ground for the arboretum, and also the peat ground for American plants, were regularly trenched over two spits deep, and three shovelings. First, we pared off the turf from the surface, then took off a spit in depth, then a shoveling, then another spit deep and lastly a shoveling to level the bottom, in all about 20 in. deep. This was done during the spring and summer of 1831, and the surface was kept free from weeds during the season. From the inequality of the grounds, the formation of the walks caused some portions of the arboretum ground to be considerably deeper of soil than others; but I cannot observe any improvement in the growth of the trees planted upon those spots where the soil was deepest. The whole was planted in the spring of 1832, with trees and shrubs from Messrs. Loddiges. The spring and early part of the summer of that year were rather unfavourable for newly planted trees; but, notwithstanding that circumstance, we lost very few plants out of the whole collection, and scarcely any of the larger free-growing species. This, in my opinion, was owing to a careful pruning and thinning of their tops, so as to make them correspond to the mutilated state of their roots.

In planting, the different natural orders were brought together

where the soil and situation were suitable for them; and, where not so, they were detached to a more congenial situation. Single species of some genera were also removed into more suitable soil, until we secured a duplicate plant, which was put in its proper place.

The plants made but little progress in growth the first season, but they have grown freely every year since. The whole arboretum is dug over every spring, and kept deeply hoed during summer. The chief nursery plants intermixed were laurels, spruce firs, and free-growing salixes; and these, whenever they got too close to the specimens, were cut out, so as to allow the specimen plants room, and a free circulation of air on every side.

The following are the heights attained by a few of the trees, by actual measurement:—

	Feet.		Feet.
<i>Acer saccharinum</i> - - -	20	<i>Quercus Cérрис</i> - - -	25
<i>platanoides crispá</i> - - -	16	<i>càna</i> ( <i>Q. Cérрис càna Arb. Brit.</i> ) - - -	10
<i>Pseùdo-Plátanus</i> - - -	22	<i>A'lnus glutinòsa quercifòlia</i> - - -	20
<i>Robínia procèra</i> ( <i>Pseùd-Acácia procèra Arb. Brit.</i> ) - - -	16	<i>oblongàta</i> - - -	20
<i>macracántha</i> ( <i>R. P.-A. macracántha Arb. Brit.</i> ) - - -	16	<i>macrocárpa</i> ( <i>A. glutinòsa macrocárpa Arb. Brit.</i> ) - - -	19
<i>Pýrus orientális</i> ( <i>P. communis salicifòlia Arb. Brit.</i> ) - - -	15	<i>Bétula álba</i> - - -	21
<i>salicifòlia</i> ( <i>P. com. salicifòlia Arb. Brit.</i> ) - - -	12	<i>pubéscens</i> ( <i>B. álba pubéscens Arb. Brit.</i> ) - - -	20
<i>A'ria</i> - - -	10	<i>angulàta</i> - - -	19
<i>americàna</i> - - -	14	<i>canadénsis</i> - - -	23
<i>spùria</i> - - -	20	<i>verrucòsa</i> ( <i>B. álba verrucòsa Arb. Brit.</i> ) - - -	25
<i>Fráxinus americàna latifòlia</i> - - -	22	<i>Sàlix álba</i> - - -	27
<i>oxycárpa</i> ( <i>F. excélsior parvifòlia oxycárpa Arb. Brit.</i> ) - - -	21	<i>nígricans</i> - - -	21
<i>simplicifòlia</i> ( <i>F. ex. heterophýlla Arb. Brit.</i> ) - - -	17	<i>Russelliàna</i> - - -	26
<i>parvifòlia</i> ( <i>F. ex. parvifòlia Arb. Brit.</i> ) - - -	21	<i>Pópulus grísea</i> ( <i>P. álba canéscens híbrida Arb. Brit.</i> ) - - -	26
<i>virens</i> ( <i>F. ex. virens Arb. Br.</i> ) - - -	13	<i>monilífèra</i> - - -	22
<i>U'lmus campéstris cucullàta</i> - - -	19	<i>acerifòlia</i> ( <i>P. álba canéscens acerifòlia Arb. Brit.</i> ) - - -	24
<i>americàna</i> - - -	18	<i>Hudsoniàna</i> ( <i>P. nígra betulifòlia Arb. Brit.</i> ) - - -	27
<i>scàbra</i> ( <i>U. montàna Arb. Br.</i> ) - - -	19	<i>dilatàta</i> ( <i>P. fastigiàta Arb. Brit.</i> ) - - -	28
<i>macrophýlla</i> ( <i>U. montàna màjor Arb. Brit.</i> ) - - -	20	<i>Pinus ponderòsa</i> - - -	10
<i>betulæfòlia</i> ( <i>U. campéstris betulæfòlia Arb. Brit.</i> ) - - -	17	<i>sylvéstris</i> - - -	17
<i>fúlva</i> - - -	19	<i>Larício</i> - - -	14
<i>strícta áspera</i> ( <i>U. campéstris cornubiénsis áspera Arb. Brit.</i> ) - - -	17	<i>sylvéstris rigénsis</i> - - -	14
<i>nígra</i> ( <i>U. montàna nígra Arb. Brit.</i> ) - - -	26	<i>A'bies Douglàsii</i> - - -	14
		<i>excélsa</i> - - -	16
		<i>europæ'a</i> - - -	21
		<i>americàna microcárpa</i> - - -	16

The American ground was also trenched over in the same manner as the arboretum. It had formerly, judging from appearances, been a drained morass, consisting of a close sour



bog-earth, that would have required turning over and separating several times to have sweetened it. It was, however, only turned over once, and afterwards some of the light sandy loam from the banks was dug in, to keep it from settling too close. It now grows most of the bog plants very well.

*Birmingham Botanic Garden, July 16. 1839.*

ART. II. *On Rustic Doors swung on Pivots, with Rustic Porches.*

By ALEXANDER FORSYTH.

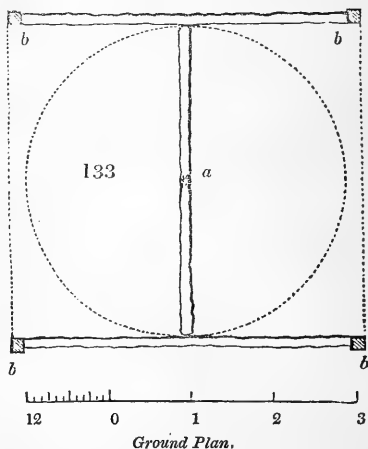
THE accompanying sketches (*figs. 133, 134, 135.*) are intended to represent a rustic gateway, 8 or 9 feet high, and 3 or 4 feet wide, through a hedge: but, before entering on the main subject, permit me, for the sake of terser argument, to premise a few plain statements relating to it; namely, on the ordinary arrangements in constructing doors and gateways in gardens and pleasure-grounds.

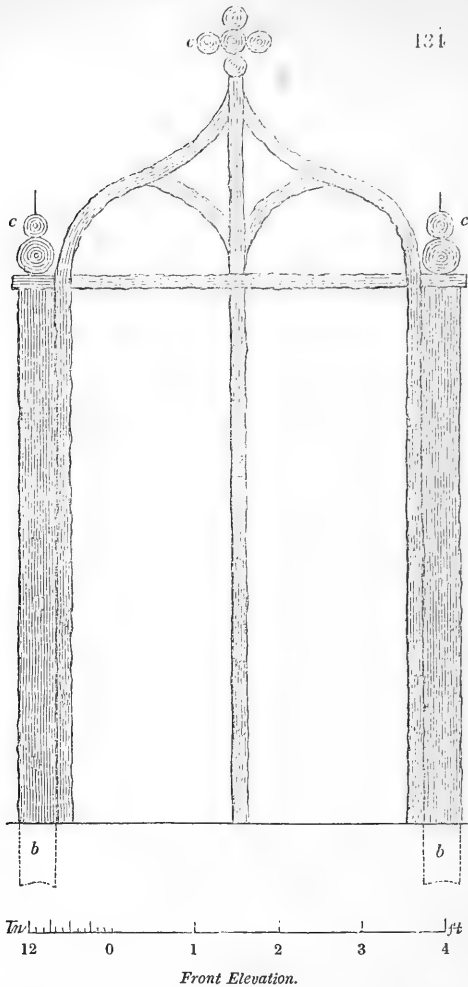
Now, we frequently find the walks inside a walled garden wide enough for a stagecoach, whilst a barrow loaded with long litter cannot be wheeled through the narrow doorway: this is often the case, also, with bridges; vehicles may pass each other freely on any part of the line of road, except on the bridge. When, therefore, a doorway in a garden wall or carriageway on a bridge, is very much narrower than the corresponding walk or road, it gives the idea of poverty. Why

should not the width of the door or viaduct be equal to the other parts of the way? The least obstruction or delay will always be objectionable.

Every body is aware that, when a heavy door is fitted into a doorway in a weak wall, it will be likely enough to pull the wall down, by acting as a lever when open, and as a powerful battering-ram when slammed against the posts by the wind, &c., in shutting.

The expense of hinges, too, for garden doors and gates is always very great. It is also very unpleasant, in conducting a party through a garden, to open a door or gate in their faces, when they are advanced pretty near, not knowing which way it folds; not to mention the hindrance, there is always an idea





of blunder about an action, when a person has to retrace his steps.

Now, the accompanying sketches (*figs. 133, 134, 135.*) are intended to convey the description of a door or gate, of the very cheapest and simplest construction, calculated to remove these acknowledged causes of complaint, and give the convenience of a spacious wide door when wanted, and at the same time, ay, and with one and the same door, two neat narrow wickets, only wide enough comfortably to admit a lady or gentleman; and, having neither doorposts nor hinges, it is not likely to clash against the one, nor creak on the other, but

swings as free as the balance-wheel of a watch, and with as little friction.

When there is occasion to carry out or bring in great quantities of grass, litter, &c., by means of a wide two-wheeled grass cart, the door is moved from the centre pivot (*a*) to the by-pivot (*e*), which one person, by laying hold of both handles, can easily accomplish; and when this clumsy lugging is over, the door is replaced on the centre pivot, and gives the place an air of seclusion, as if it were for pedestrians only, a private pleasure walk. Seven years ago, I had to get several rustic gates erected, where the walks crossed the lines of hedges that surrounded a kitchen-garden and flower-garden mixed; and, using every economy, I found the expense of double-embracing hinges to be very great, to avoid which I tried pivots, and found that a moderate-sized gate could be hinged with little more than a pound of iron by this means.

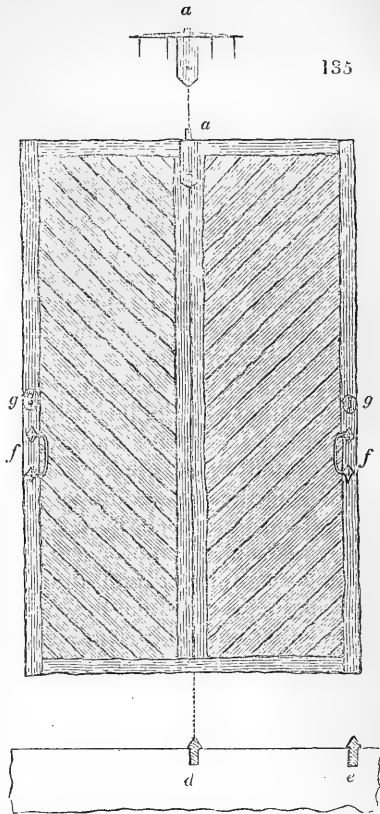
*Fig. 133.* is a ground plan; in which *a* is the centre pivot on which the door turns, and *b b b b* the four posts which form the porch.

*Fig. 134.* is the front elevation of the porch, the door being open; *b*, the posts; and *c c c* globular ornaments made of sections of round trees, with iron rods that hold them in their places.

*Fig. 135.* is the elevation of the door, without the door-frame, with a view of the stone sill; *a*, the centre pivot at the top of the door; *d*, the centre pivot in the sill; *e*, the by-pivot in the sill; *f*, the handles; *g*, the locks.

This door or gate, without the porch, is the wildest-looking thing on earth; but, with the porch, it looks like a resting-place or rustic seat, when the door is shut.

*Alderley Park, Cheshire, Halloween, 1837.*



*Elevation of the Door without the Door-frame.*

ART. III. *Remarks on Garden Tallies.* By W. H. BAXTER.

*KYANISING for Tallies.* — Kyanising, in the case of horticultural tallies is altogether unnecessary; for, however efficacious it may be in buildings likely to be attacked by dry-rot, in the case of garden tallies it is totally useless. I say this to prevent persons going to the expense of Kyanising wood for tallies; for many might think, as I did, that it would give durability to the wood, and thereby prevent so speedy a decay as usual. Had this been the case, the application of it would have been invaluable to every gardener who has occasion to use any quantity of small wooden tallies for pots, unless he has plenty of help and leisure to restore them; for, under the present circumstances, it is found that such tallies will not last, if exposed to the weather more than 15 or 18 months. I allude more particularly to this kind of tally, because my observations were made from such; and I find that, in several situations, those which were Kyanised, and which have been in use now but eight months, are so far decayed that the lower ends may be easily broken to pieces between the finger and thumb; while those of the same date, and in the same situations, which were not Kyanised, are but in a similar state of decomposition.

*The Menogramme.* — The menogramme of Mapplebeck and Lowe I find equal in durability to any pendent tally, and, for their neatness and cheapness, they must supersede all wooden tallies of their kind for the use of nurserymen, dahlia-growers, &c., and in all cases of trade; but for private collections they are unsightly, giving the general appearance of business rather than of pleasure. I nevertheless would wish them amply to repay their proprietors; for the small space they would occupy in the drawer of the counting-house or seed-shop, and their readiness for use, requiring only to be slightly damped, instead of the usual form of painting the tally previously to writing on it, are of themselves sufficient to recommend them to the use of all who are in constant need of such tallies.

*Conservatory, Green-house, and Stove Tallies for private Collections.* — Of the various kinds of tallies for the above particular purposes, none have come under my observation so cheap and neat as those manufactured by Wright, at Shelton in Staffordshire; which, when neatly lettered with the generic and specific names in full, cost but about threepence each, and last for at least four years; and, instead of being unsightly, they rather add to the appearance of the place, and to the enjoyment of such as delight in knowing or in learning the names of plants.

*Tallies for Alpine Rock Plants, &c.* — It is almost needless to say, that none can supersede strips of lead neatly stamped with

the generic and specific names in full, and which will last as long as a tally may be required.

*Tallies for general botanical Garden Purposes in the open Garden.* — For these purposes, none, in my opinion, both for appearance and durability, surpass moderately sized oak tallies, with a beveled surface for the name, which, when well painted, will remain distinctly legible for four or five years, when they may be taken up, cleaned, repainted, and relettered, and they will then appear nearly as good as when they were new. The usual colour of these tallies is white lettered in black; but, for naming pinetums or single trees on lawns, a grass-green lettered in white is far preferable. Tallies of this kind, made of  $\frac{3}{4}$ -inch oak 10 in. high and  $3\frac{1}{2}$  in. wide, have been found to last upwards of twenty years. This is rather an expensive tally in the first instance, but, when a garden is once supplied with them, the annual outlay to keep up the stock is trifling. Making, painting, and lettering of this kind amount to about sevenpence each tally.

The next most recommendable kind is of yellow deal, made of  $\frac{1}{2}$ -inch wood, 1 ft. in length and 2 in. wide, rounded on the top and painted at bottom. Tallies of this kind are not so durable, on the whole, as oak; but, if they are kept upright in the ground, one lettering is found to remain legible as long as the wood lasts. In a damp situation (a border appropriated to sedges and ferns in the Oxford garden), tallies which have been lettered nine or ten years are now distinctly legible, though their lower ends are much decayed. The cost of this tally is about fourpence each.

Either of the above-mentioned is far preferable to slate, brick, or any other composition, because they are not subject to the influence of frost or breakage; and to iron, because they are not subject to corrosion, nor are so apt to be displaced or sunk into the ground in raking and cleaning up the borders, which, without the greatest care of the gardener, is unavoidably the case with iron tallies. Owing to the smallness of the part which is stuck into the ground, they are constantly being turned round or overturned altogether, which gives them a slovenly appearance, unless they are as constantly replaced, which is a continual trouble.

*Tallies for naming Trees, &c., against Walls.* — If it is deemed necessary to nail the tally against the wall, which in most cases is found to outlast those stuck into the ground, lead, porcelain, or wood may be used at discretion. Lead, stamped as recommended for alpinses, &c., is preferable for durability, but for appearance porcelain is most recommendable. Wooden tallies, painted green and lettered white, have a good and neat appearance, and are found to remain perfectly legible for seven

or eight years, and, if under a coping, for twenty or even thirty years.

*Tallies for Water-plants, in Ponds or Margins of Lakes in Pleasure-grounds.* — The best kind of tally I have seen for this purpose is of the following kind. An oval piece of zinc, attached obliquely to a rod of copper, brass, or iron, leaded into a piece of stone worked flat on the under surface, which steadies it in the mud; the length of the rod requiring to be regulated by the general depth of the water into which it is to be plunged, leaving the face of the plate about 2 in. above the surface of the water. This kind of tally, with an oval plate about 5 in. by 3 in., will take the generic and specific names of a plant, sufficiently large to be perfectly legible at a distance of 15 or 20 feet. This tally has a much better appearance painted green and lettered white, and costs, with a brass or copper rod, about 2s. 6d. each; with iron, which lasts for many years, about 1s. 6d.

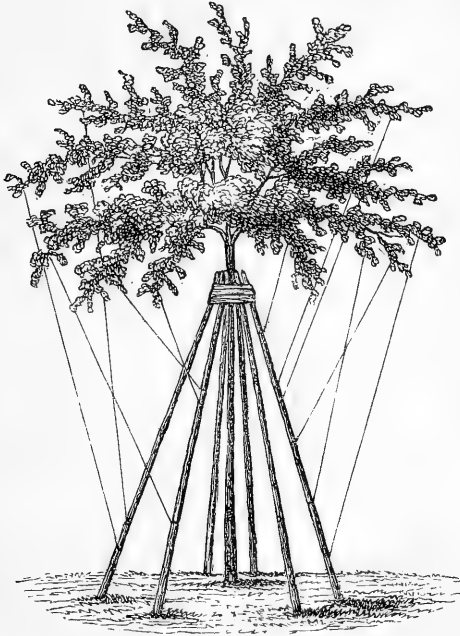
*Labels suited to receive Numbers, not Names, of Plants, and the Mode of numbering allowed to be most simple and durable.* — The most simple and durable mode of numbering is found to be that of Seton, which consists of simple lines and notches cut into the tally (see *Hort. Brit.*, p. xxi.); the next, Roman numerals, which may also be cut into the tally with a knife or chisel. To form tallies to receive numbers of this description, take firm ash rods, about 1 in. or 1½ in. in diameter; saw them into lengths of 10 or 12 inches; point the lower end rather abruptly; and either plane or cut with the knife a surface sufficient to receive the number required on the upper half. This kind may be made by the labourers during the winter and wet weather, when little else can be done; and a stock kept on hand for use, if required. They are found to last eight or ten years, according to situation. This sort is preferable for out-ground purpose; but, for pots or pendent numbers, strips of wood made thicker and narrower than those for receiving names, or strips of sheet-lead which may be stamped with a blunt or round-edged chisel, will be found most serviceable.

In the above remarks, such tallies only are noticed which, from practical observation, I find to be the most recommendable for general purposes, of all the various kinds which have come under my hands during several years of professional practice in lettering botanical tallies, and working amongst them afterwards, and thereby gaining the true result; and the above-mentioned kinds will, I think, be found the most durable and neat of any that are now in general use in gardens.

*Botanic Garden, Oxford, June 17. 1839.*

ART. IV. *On different Modes of securing newly planted Trees against high Winds, with a new Plan for that Purpose.* By SAMUEL TAYLOR.

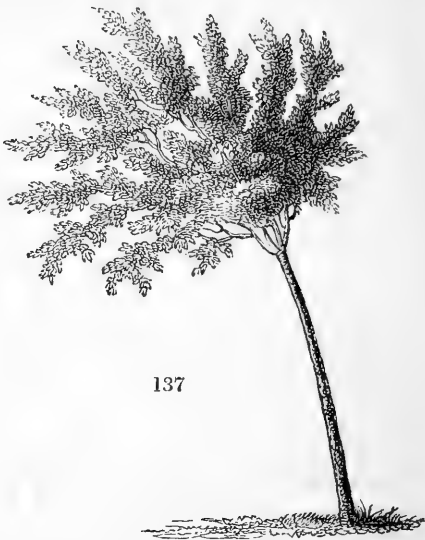
I OFTEN amuse myself with some of the by-gone numbers of your Magazine, and in the course of these my researches, lately stumbled upon an article in Number 33. Vol. VII. p. 445., by Wm. Thom, Esq., on supporting recently removed trees. The confidence with which this gentleman speaks of his plan or plans (for he has divers) to effect this object amused me a little: but seeing that the one he most relies on consists in



136

driving a nail into the stem of the tree, I exclaimed at once, "He has not hit the right nail on the head, at all events. Why, the remedy is worse than the disease." It certainly does not apply to such a case as mine, where all the trees and shrubs are only 7 to 8 years old; but where, from their great exposure to strong westerly winds, however firmly rooted, their tops have an inclination in a contrary direction. To counteract this, I began with stakes and hay-bands; but I soon found these, however firm at first, of no avail. The trees got sadly chafed, which chafed me quite as much as the trees: so I had recourse to cords; not "guy-ropes," Mr. Thom: and what do you think put this into my head? The adventure of

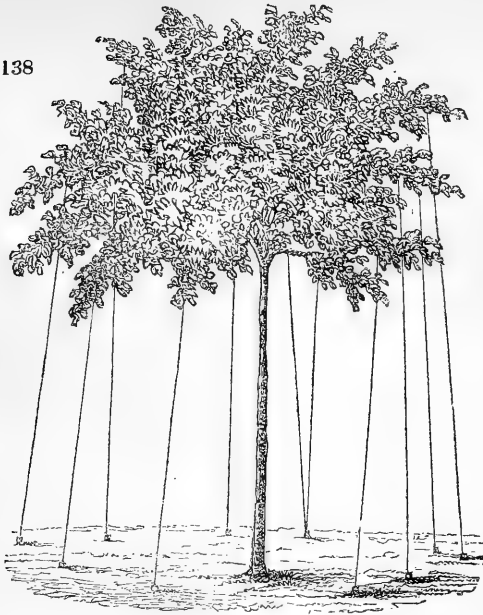
Gulliver among the Lilliputians, who was held down, not by the thickness, but the number, of the ligatures they employed. I have, for instance, on my grass-plot a young crimson thorn, the head of which is handsome, but large in proportion to the size and strength of the stem. Loath to cut it in, I first tried three stakes and a requisite bandage. It soon got liberty. I then added three others, making in all six. Still there was a tendency to loosen the bandage, and, by consequence, a risk of chafing. Then I caught a sight of the prospectus of your *Suburban Gardener*, in the which is depicted a tree, whose branches are tied to its own body, and thus made to weep against its will. The device found favour in my eyes, and I forthwith resolved to set the Lilliputians and you to work about my thorn; and I must needs say, you have both played your parts to admiration. Here you are (*fig. 136.*) pulling away in right down earnest.



And do not you think, Sir, such a mode of fastening a young tree is preferable to driving a nail into the bole? I know it is; for the cords, being fixed to the stakes, keep the top so steady, that, though we have had some heavy storms, I have never seen the least tendency in it to break loose. And then only look at the opportunity it affords of training a tree in the way it should go. My cord, by the by, is drawn too clumsy. It need not be thicker than whipcord, and, at a very little distance, is not visible. As to its injuring the tree by impeding circulation, Mr. Thom may make himself perfectly easy; for the branches should not, and need not, be tied down (especially at first) so tight as not to allow some little play, of course not enough to hazard any thing like chafing. How, indeed, should circulation be impeded, when the cord, being tied in a pretty large noose, has a bearing only on the upper part of the bough to which it is attached? So much for a tree which happened to be already previously well staked; but I have every reason to believe that the cords alone, made fast to very short foot-stakes, would have been equally effective. Indeed, all my other trees and shrubs, where fastened at all, are so fastened. I will



138



just give, as an instance, another young thorn, the head of which, like many other heads you and I have known, had been turned, and, in fact, was becoming quite deformed by the action of the wind, as in *fig. 137*.

Now, only see what may be done by the Gulliver principle. Here is the same tree brought by merely a few short stakes and cords (as near as I could manage them, of equal tension) to a perpendicular direction, and nobody can deny the superior form of the head. I do not know a more perfect practical application of the motto, "Union is strength."

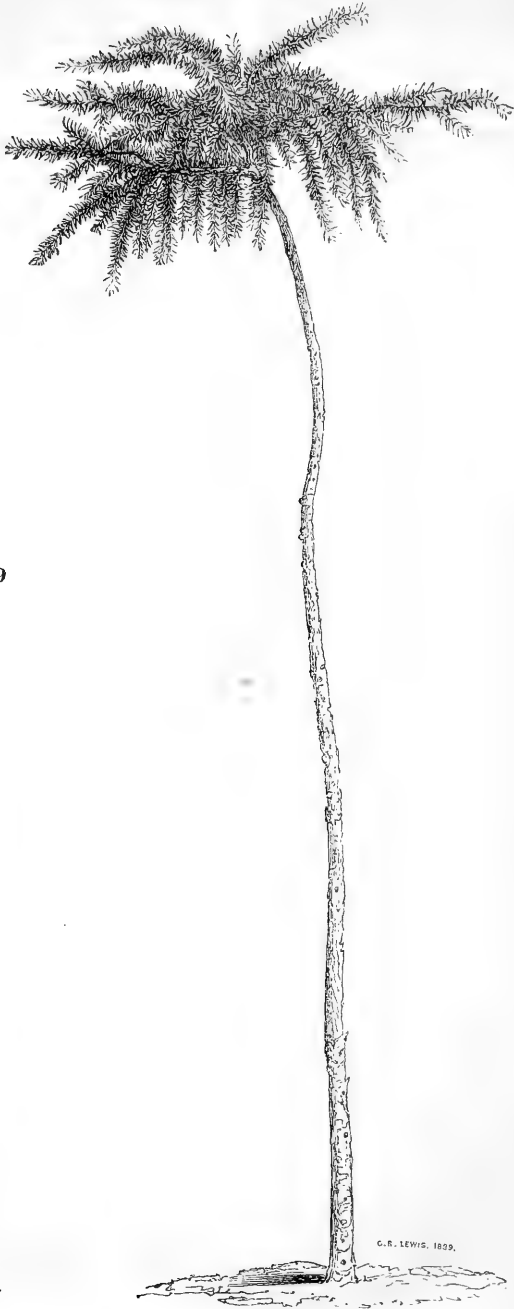
*Whittington, Stoke Ferry, Norfolk, March 4. 1839.*



ART. V. *An Account of a new Weeping Larch.* By W. GODSALL.

I BEG to say I have raised a larch which, I conceive, is a novelty, and will form a new and picturesque feature in arboretums and other plantations.

I discovered it, some years ago, in a seed bed, trailing along the ground, when I transplanted it to a situation affording more scope for its progress. Since first observed, and for a period of eight years, it has uniformly retained its prostrate habit, and, with its progeny, it has been seen by many amateurs, nurserymen, and gardeners, all of whom consider it a valuable



139

C. R. LEWIS, 1829.

acquisition. I have rather extensively worked it at standard height, and its peculiar pendent property, in that position, is faithfully portrayed in the annexed engraving (*fig.* 139. from a drawing by Mr. Lewis, whose abilities I know you highly appreciate) of a plant three years grafted, and from which pruning has been scrupulously withheld, to ascertain its habit and capabilities; as we know the knife is frequently resorted to in all drooping trees, in order to impart a more decided character thereto.

[This larch may be termed *Làrix commùnis péndula* God-sálliz.]

*Hereford Nursery, August 29. 1839.*

ART. VI. *On Cereus senilis, the Old-Man Cactus.* By D. BEATON.

YOU will, no doubt, recollect that about this time two years I made some noise about a batch of supposed seedlings of *Cereus senilis*, which I raised from seeds received as those of *C. senilis*, from M. de Champs, the Frenchman whose importation of *Cácti* at that time may be said to form an era in *Cáctus*-growing in this country. When these seedlings made sufficient growth to develop their characters, it was ascertained that they were not seedlings of *Cereus senilis*, but of *Echinocáctus íngens* of Zuccarini. This was, of course, a great disappointment at the time, which was soon modified, when we were told that *E. íngens* was fully as interesting and valuable as the "old man;" yet I find there is a something in the character of this vegetable grand-papa, which makes it a peculiar object of interest with every one who sees it. It is but justice to add, that I have not the least doubt, that in this he had no wish to deceive us; he knew very little about plants, the greatest portion of his cargo of *Cácti* he bought from the natives, during his mercantile excursions into the interior of the Mexican republic. He bought the seeds in question, as the produce of a *Cáctus* with an immense woolly head, *vértice lanatíssimo*, as botanists call it. Having a top of *Cereus senilis* in his possession which corresponded with this description, he, at once, concluded that the seeds belonged to that species, and hence the mistake and disappointment.

This woolly top died on its way to England, and was bought by Mr. Harris along with other dead unique specimens, for his cabinet of botanical curiosities. It was seen here by many eminent botanists, and other scientific men; but no one believed it could be the top of a *Cereus*, and it was too large to be compared with the tomentum, or woolly head, of any species of *Melocáctus* hitherto known; in short, it was a

perfect puzzle. Mr. Harris, with the laudable view of making it generally known, made a present of it to Mr. Lambert, in whose museum, in Lower Grosvenor Street, it may now be seen every Saturday. Here it has created a considerable interest, but yet it has been a puzzle to the cognoscenti, both foreign and domestic. It has been variously named; some call it lady's muff, some the Mexican lamb, some the vegetable sheep, &c. &c. Mr. Harris now becoming very desirous to clear up this puzzle, and to procure, if possible, a living specimen of this *muff*, forthwith wrote to his Mexican collector, and to J. Parkinson, Esq., our consul-general at Mexico, giving them a *carte blanche* to procure it, dead or alive. Through the indefatigable exertions of Mr. Parkinson, I am now enabled to state that the muff, sheep, or lamb, so called, is really the flowering top of what has hitherto been described as *Cereus senilis*. I am also enabled to state, having three specimens of this puzzler before me, that, according to the definition of botanists, the *Cereus senilis* is no *Cereus* at all, but a downright, or rather an upright, *Echinocactus senilis*. It now appears that at a certain age the *Cereus senilis* throws out a tuft of wool from each tubercle on its angles, in a zone below the summit of the plant; these tufts of wool are generally an inch in diameter, and from  $2\frac{1}{2}$  in. to 3 in. long. From the closeness of the angles and tubercles, these tufts form a dense and very compact mass of woolly matter, interspersed with the rough hairs peculiar to the species. When 18 in. or 2 ft. of the top of a plant in this flowering state are cut off, and the fleshy portion scooped out of the centre, they give a fair representation of a lady's muff.

The tufts of wool stand at right angles with the axis of the plant, and in the centre of each tuft a flower is produced, so that this species flowers in zones under the summit of the plant, in the manner that the greater portion of the mammillarias flower. The flowers are those of a true *Echinocactus*, and probably not so large as those of *E. cornigera*; the sepals become rigid, and, as the flowers fade, the petals fold inwards, or are what a botanist would call convolute; the remains of the sepals form a stiff horny tube, about an inch long, on the top of the seed-vessel. These tubes want the imbrications peculiar to the tubes of *Echinocactus*. By some defect in the pollen, or stigma, or, perhaps, by the style being longer than the stamen, and the flowers being produced in a horizontal position, the fertilisation of the seeds very seldom takes place in this curious species; and this may account for the scarcity of the plant. Out of several hundreds of flowers produced on our specimens, I only found two seed-vessels; but from these I expect young *old men* in abundance, and you had better register the birth of the first one, which came into existence this week as naked as

ever did any of Adam's race, but I expect, ere the winter sets in, he will be partly clothed by his own delicate white hairs.

The *Cereus senilis* was introduced to this country nearly twenty years ago, and named very appropriately by the late Mr. Haworth, a botanist well known for his devotion to the succulent tribes of plants. It has since been acknowledged to be a *Cereus* in this country and on the Continent; and yet we now see that it ought to stand in the genus *Echinocactus* of Link and Otto, according to the rules laid down by these great manufacturers of hard names for the natural genus *Cactus* of Linnæus, when divided into artificial genera.

The genus, or this group of prickly plants, is laid down by the unerring hand of nature in four grand natural divisions; and each of these divisions, again, is so natural in itself, that a child might be taught in a few hours to place all the species belonging to the genus, hitherto known to us, in their respective sections, without any difficulty whatever. There is not a genus in the catalogue whose divisions are more natural than those of the genus *Cactus*. Grouping the plants of extensive genera into natural divisions, for assisting the memory, or for arranging them for culture, or for the effect they are capable of producing, is one of the most serviceable labours of the scientific botanist, and one which is always hailed by the gardener and amateur as a real assistance to their labours. The practice of grouping the species of a genus, or the genera of certain families of plants, cannot be too highly valued, provided such divisions are formed on natural or sound principles; but, when such groupings are produced in opposition to these principles, as the sections of the genus *Cactus* stand at present, they amount to a public nuisance. The plants belonging to the first division of the genus *Cactus* are the most natural in the world; but, as they now stand, they figure away and are associated with plants of other sections of the genus, to which they have no resemblance whatever. They are all round or oval bodies, with vertical or spiral angular ribs, on which are produced tufts or fascicles of spines. This division includes all the *Melocacti*, and a great portion of the *Echinocacti*. How any man, or set of men, could divide a group of plants so obviously natural, must be accounted for by their endeavouring to form genera where only one genus naturally existed, and by fixing on a less essential character before a greater or more natural one, as a generic distinction; just, as a countryman would say, by placing the cart before the horse. Instead of fixing on the outward or natural appearance of the plants for sectional distinctions, they depend on the size, shape, or position of the flowers as a generic character. Some species of each natural section produce their flowers exactly alike, and every attempt to reconcile

them by their flowers only increases the difficulty of arranging them on a satisfactory basis.

In consequence of this false standard, we have grouped together the most anomalous forms; and this entirely destroys the associations rising in the mind in reference to the meaning of the typical names of the groups, which in itself is a great hindrance to the memory; thus, *Echinocactus* is associated in the mind with a hedgehog and a prickly plant; that is, a round prickly plant. Instead of adhering to the unity of the expression, by having all the plants in the section representing the meaning of *Echinocactus*, we have plants included in the section from 1 ft. to 20 ft. long. This, of course, does away with the idea of a round prickly plant like a hedgehog. The names *Melo-* and *Echino-cactus* literally convey the very same meaning; that is, round or oval prickly plants. Their application is so far unfortunate; yet, if the *Echinocactus*-flowering *cereuses* were kept apart from them, little confusion would arise by the adoption of the two names.

Through the difficulty of reconciling a group of true *Echinocacti* with the false character laid down for that section, Professor Zuccarini lately established another genus, called *Echinopsis*, to include all the tube-flowered *Echinocacti*. The meaning of this new typical name, when applied in contradistinction to that of *Echinocactus*, is little short of absolute nonsense; yet it is admitted by Link and Otto in their new work on *Cacti*, reviewed in your last Number, p. 522. More difficulties may be expected as new species are introduced. The true and natural way of dealing with this section, as well as with the other sections of *Cacti*, is, to fix on their outward forms for sectional characteristics, as Dr. Lindley justly remarks in the *Botanical Register* for last May, tab. 24. Their flowers might then very naturally divide them into subsections.

One might easily show how to arrange these subsections; but, very likely, most of your readers think they have enough of prickly plants for the present. I have in practice met with the difficulties which gave rise to these observations, and can assure the reader no personalities are meant.

*Kingsbury Gardens, Sept. 7. 1839.*

---

ART. VII. *On the atmospheric Moisture of Hot-houses; on the Management of Orchidaceous Plants; and on gathering and packing Orchideæ for long Voyages.* By D. BEATON.

IN reference to Mr. Wailes's letter (p. 506.), I wish he had fixed on some one else, who may have more time on his hands to do justice to his proposition of horticultural meteorology. I

am afraid my efforts in aid of his scheme will, in the long run, turn upon the adage which tells you "You must take the will for the deed." Yet the thing is well worthy the attention of those who can follow it up to a satisfactory result. To obtain such a result, on which amateurs and others could safely rely and act, would certainly be, as he justly remarks, of essential service to all interested in gardening. After all our science and successful practice, we have not any thing yet tangible in the way of horticultural hygrometry. The whole thing is a mere chaos, from which chaos every gardener carves as much as suits his own views. It is by no means an easy matter to arrive at a desirable result, even if we were to register accurately our barometric and hygrometric observations for a series of years. There are very many circumstances of a local nature constantly at work, either for or against the views of the experimentalist, over which he may have no control; yet this is no argument against the commencement of keeping such registers of the heat and moisture in our plant stoves. I am not very sanguine as to the result of my own observations, but I certainly will make a beginning.

My esteemed employer, Mr. Harris, has already paid a good deal of attention to this subject, and is fully aware of the importance of a well regulated atmosphere for the different families of plants in his collection. He placed one of Mason's double thermometers in our *Orchidéæ* house, which is certainly of essential service, as far as my superintendence is concerned. In the growing season we keep the wet and dry thermometers pretty close to the same degree, not by syringing, but by pouring water on the paths, and every spare place in the house. In winter, the dry, or common, thermometer is allowed to rise from  $5^{\circ}$  to  $10^{\circ}$  above the wet one. I may as well mention that, for many years, I believe that I and a few other gardeners keep all our houses rather moister than is generally done by others. The result is, a more rapid, and, perhaps, a healthier state of vegetation, at the expense of flowers; for I do not think that plants pushed on in their growth by strong stimuli are such free flowerers as when this is not done; and when we consider the real nature of inflorescence, we need not expect to obtain both objects by our treatment. For my own part, I like to see plants always in a healthy state. But I am travelling too wide of the mark, for I do not include orchidaceous plants generally under these remarks, and consider, in their case, as I do in that of the generality of bulbs, that they must have their season of rest, if you wish them to flower. If you merely wish to increase their size, without much regard to flowering, you should, and must, keep up a stimulus all the year through. No one that I am acquainted with keeps up such a stimulus to

orchidaceous plants as the Messrs. Loddiges, and I need hardly say few are so successful in their cultivation, and especially in their propagation.

To make these observations bear on Mr. Wailes's enquiry, let us suppose three orchidaceous houses of the same size and aspect, and each filled with the same kind of plants, and treated for three years as much alike as possible, in regard to heat, air, and moisture; it is a hundred to one if all the species will be found to flourish in the same degree in each house. Much of the success of growing orchidaceous plants, or, indeed, any kind of plants, depends on certain manipulations, or minutiae, which can neither be taught nor described; but which must be learned by experience: and this is the only point, in the whole circle of cultivation, where the empiric has the advantage of the man of science, and a point, too, from which he is not likely soon to be driven.

As regards my treatment of newly imported *Orchidaceæ*, and the rearing of young and unestablished plants of this interesting family, the following is the substance of my answer to Mr. Wailes, the publication of which may be of some use to those beginning to grow this tribe of plants; or to those having botanical correspondents in tropical countries, where these plants can be procured. Besides, I made a conditional promise to Mr. Wailes to publish this answer, if he would allow the publication of his very interesting letter on horticultural hygrometry, which is a fit companion to Mr. Ellis's valuable paper (p. 481.), bearing in a great measure on the same subject. Papers or discussions of this nature are much wanted in horticultural literature. *We* of the old blue apron school are getting tired of planting cabbages, pruning roses, and watering cauliflowers.

But to return to the *Orchidaceæ*, the paper alluded to by Mr. Wailes, in *Paxton's Magazine of Botany*, is from a private communication of mine to Mr. Paxton, part of which I would have omitted, if I had thought it was to be published. However, as far as it goes, it gives an idea of the practice I then followed, and which I follow still, with little variation. If I were allowed to speak through the trumpet *Orchidææ* (*Epidéndrum tibícinis*), I might say that the collection at Kingsbury, as far as its age is concerned, shows as much evidence of successful cultivation as any such collection in the country. It (the paper in *Paxton's Magazine*) also shows the aversion I then entertained of pot culture for this tribe, and that aversion has been increasing ever since; and I am quite certain that no argument will ever induce me to reconcile myself to the present hideous mode of pot culture, viz. the plants placed on mounds of earth raised over the tops of large pots. Add to this, the still more frightful system of plunging these large pots in tan, to receive bottom heat. The heat from the tan is all gone in a few



weeks, and must be succeeded by a fresh supply of tan, a fresh shifting and tumbling of pots and plants, or what is too often the case, the tan is not renewed for months, or till it is swarming with worms. It is then in a damp, cold, disagreeable state, fit for nothing but to destroy such of the roots as find their way outside the pots. I have witnessed this system, such as I have described it, in a large establishment near London, once celebrated for growing *Orchidaceæ*, where nothing but the active perseverance of the superintendant kept the whole thing from falling into a perfect wreck; and, after all his ingenuity, many of the species disappeared, or were removed, in consequence of their being unfit to be seen by visitors. I must qualify these observations, however, by stating my firm belief, that if a proper system of bottom heat by hot water were adopted, where a uniform temperature could be kept up without disturbing the plants during their growing season, it would be of the greatest advantage, and far preferable to our present system, at least for young plants; but in that case, also, I would use no pots. I would have all my plants in flat-bottomed copper-wire baskets, placed on the tops of pots plunged in some imperishable medium over the hot-water pipes, the pots acting as so many chimneys discharging the hot vapour arising from the pipes, and through which water might be poured down occasionally, to raise the vapour.

In the paper alluded to above, I noticed how I grew some of the species on forked stiéks. Mr. Fortune adopts the same system at the Horticultural Society's garden, with stanhopeas, and such like plants, and with perfect success. Copper-wire baskets, or baskets made of iron wire, and painted with anti-corrosive paint, when properly constructed, are quite as handy for stages and shelves as garden pots, and may be hung up at pleasure. These are the sorts of things to grow these plants in to the greatest perfection, and with the least possible attention. Most kinds of baskets now in use are liable to the same objection as pots; that is, they are too narrow and too deep, which causes the turf with which they are filled to turn sodden in the heart, and this rots the roots as fast as they get hold of it. Baskets ought to be very shallow, and wide in proportion to the size of the plant: 6 in. deep is sufficient for any orchidaceous plant which I know. The general size should be from 3 in. to 4 in. deep, and from 6 in. upwards in diameter, the bottoms nearly as wide as the tops. To fill a basket, cut your turf 2 in. or 3 in. wide, and as deep as your basket; place these pieces on their ends round the inside of the basket, just as a cooper would put up an orange tub, the pieces of turf representing the staves of the tub. These are not to be put quite close together. The bottom is then to be laid over with pieces of the same turf, and

then the basket filled with any rough pieces. The plant is then fixed in the centre; or if you have several plants of the same species nursed on lumps of turf, or in moss, or in small pots, you can fill your basket at once with these little fellows, and have a handsome specimen immediately. If the plant is a very delicate kind, instead of filling the basket entirely with peat, place an inverted flower-pot in the centre of it, and fill the space between this pot and the sides of the basket with crocks and turf in equal proportions. Peat will not soon get sodden in these baskets. When the basket is to be put on a flat stage, let it be set on an inverted pot; in this way it is in a measure suspended in the air: and, when you want to give it bottom heat, place the basket on the top of a pot plunged in heat. When your plant is in flower, wrap moss, paper, or some such article, round the basket, and take it to the drawingroom. This will obviate the necessity of ladies entering the orchidaceous house, which few of them like to do, and the change will be a great benefit to your plant. After unloading itself of its beauty and fragrance in the drawingroom, it will begin growing when brought back to the orchidaceous house with redoubled exertions. If your plants are very small, do not let them flower, but pick off the flowers as they make their appearance; and *mark this!* if you find the plant will stand this treatment without much injury, never let it rest, winter or summer, till you have got it into a strong fine specimen; but, if you do this, you must not let it waste itself in producing flowers.

*Gathering and packing Orchidaceæ for long Voyages.* — Without detailing the various ways in which I have seen plants of this tribe packed, and I believe I have seen them packed in as many ways as most people, I have made up my mind that very dry sawdust is the very best medium for packing them in, and the larger the cases in which they are packed, the more likely they are to arrive safe. The rationale of the plan appears to be, that sawdust is a powerful non-conductor of heat, and resists moisture. The roots and the leaves of the bulbous kinds should be cut off before packing. When circumstances will admit of it, the cases should not be filled at once, nor the lids put on as soon as filled; time should be allowed for any exhalations which may arise from the plants to pass off, before nailing them down. Let the tenderest species be kept towards the centre of the case. The effects of a vertical sun have little power on a large body of dry sawdust, and I have not the least doubt, but that this material is also the safest medium in which to transfer tender seeds.

After receiving a cargo in this way, I put the plants in a trough of water, and clean them from ants and other insects, and all decayed matter; leaving them, perhaps, several hours in water. After cleaning them, in summer I pile them on each

other in a close room, and throw a damp mat over them. Some of the strongest and driest sorts are left in this state for several days, sometimes a week or two. Without receiving any stimulus to growth, they imbibe sufficient moisture to enable them to push their eyes and shoots freely, when taken into the Orchídeæ house. Sometimes it is more convenient to place them in drier houses than the Orchídeæ house; in that case they are kept moist by being placed on wet moss, and syringed occasionally; in either case they are not potted, nor put into baskets, till their roots are beginning to appear. The beginning of the rainy season is the best time for collecting them in their native habitats, as their growth is then beginning. We had some home lately, gathered in that state, which were fit to be hung up as soon as they arrived. In ordinary cases, most of the species will do well enough in the common moisture of the Orchídeæ house, when first arrived; but the excitement of this treatment is too much for some, till they have slowly imbibed moisture sufficient to sustain stimuli. Of this kind are the beautiful *Epidéndrum bicornutum* and *tibicinis*, and all those with hollow tubes or hollow bulbs. As a proof of this, plants of a species of *Epidéndrum*, the *Flor del Mayo* of La Guayra, may now be seen in Messrs. Loddiges's very damp and very hot Orchídeæ house, with little or no growth; while at Clapton the same species, received at the same time, is in active growth, Mr. Low not keeping much stimulus: and, here, the same sort, having had a fortnight's cold damp treatment, is now in the most vigorous growth. A species of *Schombúrgkia*, or the spread eagle, as it is called, which is well known to be shy at vegetating soon after arriving in this country, under this treatment grows as freely as *Epidéndrum cochleatum*. *Lælia grandiflora*, *autumnalis*, *álbida*, &c., and some others, from the higher parts of Mexico, are very difficult to start, but, treated in this way, and placed in wet moss in a cool house, with a constant draught of air, are pushing away as regularly as any of the tribe. But time and room will allow of no further details at present.

Kingsbury, Sept. 14. 1839.

---

ART. VIII. *Botanical, Floricultural, and Arborescultural Notices of the Kinds of Plants newly introduced into British Gardens and Plantations, or which have been originated in them; together with additional Information respecting Plants (whether old or new) already in Cultivation: the whole intended to serve as a perpetual Supplement to the "Encyclopædia of Plants," the "Hortus Britannicus," the "Hortus Lignosus," and the "Arboretum et Fruticetum Britannicum."*

*Curtis's Botanical Magazine*; in monthly numbers, each containing seven plates; 3s. 6d. coloured, 3s. plain. Edited by Sir William Jackson Hooker, LL.D., &c.

*Edwards's Botanical Register*; in monthly numbers, new series, each containing six plates; 3s. 6d. coloured, 3s. plain. Edited by Dr. Lindley, Professor of Botany in the London University.

*Paxton's Magazine of Botany, and Register of Flowering Plants*; in monthly numbers; large 8vo; 2s. 6d. each.

*The Floral Cabinet*; in monthly numbers, 4to; 2s. 6d. each. Conducted by G. B. Knowles, Esq., M.R.C.S., F.L.S., &c., and Frederick Westcott, Esq., Honorary Secretaries of the Birmingham Botanical and Horticultural Society.

*The Botanist*; in monthly numbers, each containing four plates, with two pages of letterpress; 8vo; large paper, 2s. 6d.; small paper, 1s. 6d. Conducted by B. Maund, Esq., F.L.S., assisted by the Rev. J. S. Henslow, M.A., F.L.S., &c., Professor of Botany in the University of Cambridge.

*Maund's Botanic Garden, or Magazine of Hardy Flower Plants cultivated in Great Britain*; in monthly numbers, each containing four coloured figures in one page; large paper, 1s. 6d.; small, 1s. Edited by B. Maund, Esq., F.L.S.

#### OXALIDÆ.

1414. O'XALIS 11900 Barrelièri Bot. Mag. t. 3743.

In the *Hortus Britannicus*, following the description of Baron Jacquin, the colour of the flower is marked as pale red; but in the *Botanical Magazine* it is represented yellow. Sir W. J. Hooker notices this discrepancy, but says that the plant he has figured is, notwithstanding, "unquestionably the *O. polymórpha* of Zuccarini." (*Bot. Mag.*, Sept.)

*Legumindœ.*

1268. BAUHI'NIA 10669 corymbdsa Bot. Reg. 1839, 47.

This beautiful Chinese shrub, though so long introduced, is said by Dr. Lindley to have resisted "all attempts to flower it until September, 1838, when its beautiful clusters were produced abundantly in the green-house at Redleaf." It will succeed best in a house where the temperature is something below that of a common damp stove. The soil should be fresh and rich; for example, peat, loam, and decayed manure. Layers or cuttings." (*Bot. Reg.*, Sept.)

1246. CHORO'ZEMA [49, and Paxt. mag. of bot. vol. vi. p. 175.  
vâriam Benth. various-leaved 莢 匍 or 4 jn Y.R Swan River 1837. C s p Bot. reg. 1839,

This beautiful species, which has been already mentioned, and named in the miscellany to the *Botanical Register*, was introduced in 1837, from the Swan River, under the name of "Native Pea." It is very showy in its flowers, and Dr. Lindley observes that two or three varieties have been raised from seed which differ slightly in the leaves. In *Paxton's Magazine* it is stated to be known in the nurseries under the names of *C. latifolium* and *C. élegans*. It is a vigorous-growing plant, and cuttings of the half-ripened wood strike easily. Those from the central shoots should be preferred, as plants raised from the side branches are likely to take their habits, which is rather straggling and unsymmetrical. (*Bot. Reg.*, and *Paxton's Mag. of Bot.* for Sept.)

3673. ZI'CHYA [52.  
tricolor Lindl. three-coloured 三 匍 or 1 myjn S Swan River 1837. C s p Bot. reg. 1839,

The genus *Zichya* having been formed by Baron Hugel out of the old genus *Kennèdya*, in compliment to the Princess Metternich, whose maiden name was the Countess Molly Zichy-Ferraris (see *Bot. Reg.*, l. c.), Dr. Lindley takes occasion, while recording this pretty new species, to enumerate the species of which the genus *Zichya* consists. These are *Z. inophýlla*, dilatata, glabrata, coccínea, Mólly, tricolor, and angustifolia; the first three of which are well known in the nurseries under their old name of *Kennèdya*. *Z. tricolor* is a

pretty little climbing shrub from the Swan River, which flowered with Mr. Young of the Milford Nursery. Seeds; or cuttings of the half-ripened wood in spring, in silver sand under a bell-glass. Pot off into light sandy soil, shaking off all the silver sand from the roots, as it is apt to bring on canker. A cold-pit kept a few degrees above freezing will afford this species sufficient protection. (*Bot. Reg.*, Sept.)

*Portulacææ.*

*Portulaca grandiflora* var. *rutila* Lindl. A very brilliant variety, with very large bright crimson flowers, and "long cylindrical leaves." A native of Mendoza. (*B. M. R.*, No. 114., Sept.)

2837. ACACIA

*Riceana* Henslow Mr. Spring Rice's  pr 4 mr Y V. D. L. 1835. C s.l.p [no. 133. Botanist,

A species of *Acacia* with yellow flowers, and sharply pointed leaves; the seeds of which were sent from Van Diemen's Land to Mr. Spring Rice, and by him presented to the Cambridge Botanic Garden, where the plant was raised. The plant requires a green-house, and its flowers appear in March. (*Botanist*, Sept.)

1945. SCOTTIA 17311 dentata *Botanist*, No. 134.

Mr Bentham observes of this plant, that it is one of those which soon become "sickly on being placed out of doors during summer, and therefore must be kept in the green-house all the year. It is most successfully increased by layers, but may be struck also from cuttings in sand under a hand-glass. Soil, sandy peat, and loam." (*Botanist*, Sept.)

*Crassulacææ.*

1309. COTYLEDON 29766 Sempervivum.

*Synonyme*: *Umbilicus Sempervivum* Dec., Fl. Cab. 116.

A frame plant, from Eastern Caucasus, rare in British collections.

*Compósitæ.*

+ *Senecio odoratus* Horn. A glaucous herbaceous plant, with small heads of yellow flowers, which, notwithstanding the specific name, are quite scentless. A native of the south-east interior of New Holland, introduced by Major Sir Thomas Mitchell. (*B. M. R.*, No. 111., Sept.)

*Eurybia glutinosa* Lindl. A Van Diemen's Land shrub, with rosemary-like leaves, and starry heads of violet flowers. "All the green parts of this plant are covered with specks of a whitish viscid exudation." (*B. M. R.*, No. 112., Sept.)

*Sesámææ.*

1719. TOURRETTIA 15463 lappacea *Bot. Mag.* 3749.

This plant, which had been long lost to the country, was re-introduced, Sir W. J. Hooker informs us, in 1837, by John M'Lean, Esq., of Lima. (*Bot. Mag.*, Sept.)

*Convolvulæææ.*

+ *Ipomœa longifolia* Benth. A beautiful white-flowered perennial *Ipomœa*, with a tuberous root, which differs from the general habit of the genus in the stems being erect, and not twining. "It will probably," says Dr. Lindley, "do very well out of doors in summer, but it will require such protection as is given to the dahlia in winter." (*B. M. R.*, No. 124., Sept.)

*Solanæææ.*

+ *Solanum candidum* Lindl. "A fine noble-looking shrub, with leaves a foot long and 9 in. broad, and clusters of large handsome pure white flowers." A native of Mexico, and appearing to require a stove. (*B. M. R.*, No. 125., Sept.)

*Scrophularinææ.*

1745. LINARIA 30183 delphinoides *Gay*, Fl. Cab. No. 115.

This "exceedingly pretty" plant appears to be biennial, instead of annual. It seems likely to perfect several "capsules of seeds, but it may be readily increased by cuttings, which strike freely." The seeds were received from St. Petersburg. (*Flor. Cab.*, Sept.)

*Labiatae.*

+ *Népeta salviaefolia* Benth. "A hoary perennial of little beauty," a native of the Himalayas. (*B. M. R.*, No. 123., Sept.)

*Myoporinae.*

*Stenochilus longifolius* A. Cunn. This shrub, which was discovered many years since in New Holland by Mr. Allan Cunningham, has been again found, and introduced by Major Sir Thomas Mitchell. The leaves are long, narrow, and leathery; the flowers of a dull greenish red; and the fruit, which is fleshy, has the odour of a lemon. (*B. M. R.*, No. 115., Sept.)

+ *S. incanus* Lindl. Another shrub from the same country, introduced by Sir Thomas Mitchell. "It forms a grey bush, looking like an olive or some leafless acacia, and is covered closely with a short white down, consisting of stellate hairs; a circumstance deserving of attention in such a natural order as that of Myoporaceae." (*B. M. R.*, No. 116., Sept.)

*Acanthaceae.*

+ *Asteracantha longifolia* Nees. A handsome green-house perennial, the "seeds of which were sent to the Horticultural Society by Mr. McCulloch, one of the gardeners to His Highness the Pacha of Egypt." The flowers are blue, and each whorl is surrounded by six spines forming a star, whence the name, which is derived from *astēr*, a star, and *akantha*, a spine. (*B. M. R.*, No. 117., Sept.)

*Orchidaceae.*

3445. CORYANTHES 28767 maculata var. Parkeri Hook., *Bot. Mag.* 3747.

Differing only in the cup-shaped appendage to the labellum being of a brownish purple, and rather larger than in the species. (*Bot. Mag.*, Sept.)

2540. ONCIDIUM?

cóncolor Hook. one-coloured  $\text{L} \square$  or  $\frac{3}{4}$  au Y Organ Mountains 1837. D p.r.w Bot. mag. [3752.]

"An extremely beautiful plant, an inhabitant of the Organ Mountains of Brazil, where it was found by Mr. Gardner in 1837, and whence it was sent by him to the Woburn collection. Of the genus itself to which it should be referred," continues Sir W. J. Hooker, "I feel rather doubtful." The flower is a clear pure yellow, without the admixture of any other colour; and its form is very unlike that of oncidiums generally. (*Bot. Mag.*, Sept.)

ODONTOGLOSSUM. (From *odous*, a tooth, and *glōssa*, a tongue; in allusion to the toothings of the labellum at the base.)

Róssi Lindl. Ross's  $\text{L} \square$  or  $\frac{1}{2}$  au W.G.Y.B Mexico 1838. D p.s Bot. reg. 1839, 48.

A "charming" plant, sent from Mexico by the collector of Mr. Barker, Mr. Ross, after whom it is named. "The bright white lip, lying, as it were, in the centre of a rich green, yellow, and blue star of three points, produces a peculiarly beautiful and unusual appearance." (*Bot. Reg.*, Sept.)

2546. GONGO'RA

fúlva Lindl. tawny  $\text{L} \square$  cu  $\frac{3}{4}$  jl Y.B Mexico 1838. D p.r.w Bot. reg. 1839, 51.

The flowers are not above half the size of those of *G. maculata*, to which this plant is nearly allied, and the raceme is much "more contracted, in consequence of the shortness of the pedicels." The flowers are very fragrant, and resemble in scent those of a violet. (*Bot. Reg.*, Sept.)

+ *Angræcum armeniacum* Lindl. The flowers are of an "apricot colour," and the plant has been obtained by Messrs. Loddiges from Sierra Leone. (*B. M. R.*, No. 109., Sept.)

+ *Malachènia clavata* Lindl. This is a new genus, "resembling *Megaclonium* in some respects, but belonging in reality to *Vandææ*." It was obtained from Rio, in 1836. The flowers are fleshy, and of a dull green spotted with purple. (*B. M. R.*, No. 110., Sept.)

*Stanhopea oculata* var. *Barkeriana* Lindl. "This is a remarkable variety of *S. oculata*, obtained from Mexico by Mr. Barker. It looks like *S. insignis*, with the lip of *S. oculata*, and is very handsome." (*B. M. R.*, No. 113., Sept.)

+ *Cirrhopetalum nutans* Lindl. A pretty little plant, with "a nodding umbel of

pale straw-coloured flowers at the end of a weak scape about 6 in. high." It is a native of Manilla. (*B. M. R.*, No. 118., Sept.)

+ *C. fimbriatum* Lindl. Very different from any other species of the genus known. Imported from Bombay by Messrs. Loddiges. The general colour of the flower is greenish, "while the upper sepal and the petals are broken up at the margin into beautiful purple fringes." (*B. M. R.*, No. 120., Sept.)

*Cirrhaea saccata* Lindl. This species flowered at Woburn in August last. It differs from all the known species "in the middle lobe of the lip being concave, and having very much the form of that of many *Satyria*." The raceme is very long, and the flowers very large. Dr. Lindley observes that "it has been figured in the *Botanical Magazine* under the name of *C. fuscolutea*, which is a different plant." (*B. M. R.*, No. 121., Sept.)

## 2547. DENDROBIUM

*Páxtoni* Paxt. *Mag. of Bot.* Paxton's £ ☒ or 1 jn Y.br Pondooah [mag. of bot. vi. p. 169. 1837. D trees Paxt.

A very showy golden-yellow and brown flowering species, surpassing all its allies, discovered in 1837, by Mr. Gibson, the Duke of Devonshire's Indian collector, growing on trees at Pondooah, a station near the base of the Khoseea Hills. Many of the dendrobiums acquire their chief nourishment from the atmosphere, or "from a very slight covering to the roots for the retention of moisture; but *D. Páxtoni* belongs to a very different class; and, besides its great height demanding some substance in which to fix the stakes needful for maintaining its erectness, the roots are more tender, and must be completely enveloped in moss or soil." (*Paxt. Mag. of Bot.*, Sept.)

amœnum Wall. lovely £ ☒ or ½ au W.v.G Nepal 1838. D trees Fl. cab. no. 117.

A very beautiful species, with a delightful, but not very powerful, fragrance. The stems are naturally pendulous; and, according to Dr. Wallich, it is found growing on trees in Nepal. (*Fl. Cab.*, Sept.)

Tulipaceæ.

## 1018. FRITILLARIA 8440 racembsa.

The figure is taken from plants raised from bulbs imported from Holland, and sold at a guinea each. The specimen has thrice the number of flowers of that figured in the *Botanical Magazine*, t. 952., and recorded in our *Hort. Brit.*, No. 8440., as introduced in 1605; but whether it is specifically different we very much doubt. In all probability, it is merely a better-grown specimen of the same variety of *F. pyrenæica*.

## REVIEWS.

ART. I. *Catalogue of Works on Gardening, Agriculture, Botany, Rural Architecture, &c.*, lately published, with some Account of those considered the more interesting.

*THE Ladies' Botany of Professor Lindley; abridged by the Author.* With numerous woodcuts. Post 8vo, pp. 424. 12s. Lond. 1839.

The title of this work, and the name of the author, form a sufficient recommendation. Dr. Lindley has done more than any other man to promote the study of botany in Britain; and this work, which comprises what is contained in two volumes at 25s. each, will do more for the science among the rising generation, and especially among gardeners, than any previous publication by the same author. Very little is omitted in this volume that is contained in the two of which it professes to be an abridgment, except the copperplates, and for these are substituted admirably executed engravings on wood.

*On the Effects of the severe Winter of 1837-8 on some Shrubberies and Gardens in Glamorganshire.* By L. W. Dillwyn, Esq., F.R.S., &c. 8vo, pp. 13. Swansea, 1839.

This is a very interesting tract, especially when taken in connexion with

Dr. Lindley's valuable article on the same subject in the *Horticultural Transactions*, Professor Alphonse De Candolle's in the *Bibliothèque Universelle*, and M. Otto's in the *Gartenzeitung*. We shall make ample use of all these papers in a volume which we contemplate on the plants suitable for a conservative wall, with their culture and management. We rejoice to find that the noble tree of *Laurus nobilis* at Margam, which Mr. Dillwyn kindly had measured for our *Arboretum*, and which is nearly 62 ft. high, was only slightly injured at the top, and has recovered.

*The Stranger's Intellectual Guide to London, for 1839-40, containing an Account of the Literary and Scientific Societies and Institutions, Exhibitions, and Curiosities; Museums, Libraries, Public and Private Collections; Botanical, Horticultural, and Zoological Gardens, &c., of the Metropolis.* By A. Booth, F.S.A., F.S.S., Member of the British Association for the Advancement of Science, &c. Post 8vo, pp. 152, with a tabular synopsis, &c., in a folding sheet. Lond. 1839.

A work much wanted, and which cannot fail to be extremely useful, even to gardeners, since it contains a list of the London nurseries, of private gardens, of public gardens, botanic and horticultural, of the zoological gardens, &c. In speaking of the gardens of the Duke of Northumberland, at Syon, it is stated that His Grace is the most successful breeder of monkeys in the kingdom; a fact which we were not before aware of.

## MISCELLANEOUS INTELLIGENCE.

### ART. I. *General Notices.*

*THE Character of Soils in Relation to Vegetable Culture.*—When a cultivator devotes himself to the investigation of a soil, it is a matter of indifference to him whether it is composed of alumina and silica, or whether these substances are in the state of quartz or felspar, or that by their aggregation they form the debris of granite, or, finally, that they belong to primitive, transition, or alluvial formations: what he requires is, to know what kind of plants the soil will produce with the greatest advantage, the trouble it will require to put it in a state of culture, the manuring it will need, the quantity of this manure it will yield to the plant, and the portion it will retain in its own substance; these are its agricultural characters, those which adapt it to the objects of agronomy, and which shed light on his researches.

What we have already said of the composition and properties of soils demonstrates that certain of their scientific elements have a relation to the properties which are enquired after by cultivators. Thus, as to the nature of the crops which may be expected from different soils, those which contain carbonates of lime and magnesia are eminently qualified to produce wheats and leguminous crops; the siliceous clay lands are the soils peculiarly adapted to forests; the siliceous are proper for plants which vegetate in winter, as rye, &c.; mould favours the vegetation of those potherbs which are cultivated for the stems, leaves, &c. As regards the facility or difficulty of working soils, those that are siliceous are easily dressed, as well as those which have an organic origin; whilst calcareous and clayey present great differences in this respect, according to the diversity of their composition. Finally, sandy and calcareous soils require frequent manuring, and this addition they decompose to the immediate profit of the plants; whilst clayey ones retain the manure, may have the process of manuring postponed to greater intervals, and receive at the same time a larger quantity of manure. Diluvian soils admit of improvement with gypsum, and siliceous clays with marl; whilst land rich in organic matters requires the dung of animals to facilitate and promote the decomposition of the mould. (*Jam. Jour.*, vol. xxvii. p. 89., for July, 1839.)



*Subsoil-Ploughing and the Frequent-Drain System.*—The advantages of these practices have lately been scientifically explained by a most intelligent and judicious writer, in the *Quarterly Journal of Agriculture*, vol. x. p. 131.; and the following may be considered the essence of the article, though to be properly impressed with its importance, the reader ought to peruse the five pages which it occupies. The subsoil in a great many instances abounds in oxide of iron, which, when perfectly dry, is insoluble, and consequently not injurious to vegetation; but when it is soaked in water it becomes to a certain extent soluble, or what in chemical language is termed a *hydrate*, and in that state it is extremely injurious. Now, the great benefit attending the frequent or the furrow drain system consists in its withdrawing the water from this hydrate, so that it may no longer be soaked in it; and the great benefit of subsoil-ploughing results from the hydrate being raised to the surface, exposed to the air, broken in pieces, and mixed with the soil, so as no longer to be injurious. Without underdraining, where the subsoil consists of hydrate of iron, subsoil-ploughing will be of little or no use; but with it the worst lands, by the aid of lime and manure, may in a short time be rendered almost equal to the best. The presence of iron in the soil, whether in the state of oxide or hydrate, is easily known to practical men by its rusty brown colour. In every soil iron is present in a greater or less degree, but only injurious when it is in a state of hydrate. In all other states it is insoluble, and therefore harmless to plants. (*Quarterly Journal of Agriculture*, vol. x. p. 131.)

*Black, the very worst Colour for painting Woodwork in the open Air.*—There is nothing that will prove this evil more than by observing the black streaks of a ship after being in a tropical climate for any length of time. It will be found that the wood round the fastenings is in a state of decay, while the white work is as sound as ever; the planks that are painted black will be found split in all directions, while the frequent necessity of caulking a ship in that situation likewise adds to the common destruction; and I am fully persuaded that a piece of wood painted white will be preserved from perishing as long again, if exposed to the weather, as a similar piece painted black, especially in a tropical climate.

I have heard many men of considerable experience say that black is good for nothing on wood, as it possesses *no body* to exclude the weather. This is, indeed, partly the case; but a far greater evil than this attends the use of black paint, which ought entirely to exclude its use on any work out of doors, viz. its property of absorbing heat. A black unpolished surface is the greatest absorber and radiator of heat known; while a white surface, on the other hand, is a bad absorber and radiator of the same; consequently, black paint is more pernicious to the wood than white. Wood having a black surface will imbibe considerably more heat in the same temperature of climate than if that surface were white; from which circumstance we may easily conclude that the pores of wood of any nature will have a tendency to expand, and rend in all directions, when exposed under such circumstances; the water, of course, being admitted, causes a gradual and progressive decay, which must be imperceptibly increasing from every change of weather. The remedy to so great an evil is particularly simple, viz. by using white, instead of black paint, which not only forms a better surface, but is a preventive to the action of heat, and is more impervious to moisture. The saving of expense would also be immense, and I am convinced that men of practical experience will bear me out in my assertion. (*Trans. Soc. Art.*, as quoted in the *Civil Engineer*, vol. ii. p. 189.) The writer next goes on to describe the effect on two ships of war, in which all the external parts painted black were in a state of decay, while the parts painted white were as sound as ever.—*Cond.*

*The Improvement of Harbours and of Drainage by Rivers* depends on the management and direction of natural causes and effects, in which, I may say, observation had been so torpid, that, till twenty years since, much more harm than good had been the result of interference. All the reports of Mr. Smeaton, and some made scarcely sixteen years since, prove that in large drainages

near the sea, natural outlets or rivers were always recommended to be stopped by dams and sluices, to prevent the tide from entering, which obstacles equally prevented the drainage water from free passage outward.

Three inches fall (downward slope) in a mile makes water move slowly; at four inches declivity in a mile, water acquires a moderate velocity, sufficient for any drainage operation; so that the sill (threshold) of a sluice, if laid a yard too high, will prevent the natural drainage of twelve miles above it (3 in. to a mile): on the same principle, if a drainage outlet, obstructed by what may be almost deemed the caprice of winds and tides, and of accumulated sand-banks in consequence, shall double its length, and creep through a dubious crooked channel, it is evident that a 3 in. or 4 in. fall may become 1 in., which is ineffectual.

The sound principle which results from these facts is, to give free ingress to the tidal water, guarding against inundation by raising the banks of your river, and also straightening its course, so as to lose no downfall. This increased downfall and increased tidal water are made to bear directly upon the old sand-banks; and, if the connexion with deep water can be established in this manner, you obtain a harbour of easy access, and the old-fashioned precarious drainage of land by windmills becomes unnecessary, the dams which previously hindered daily drainage at low water being for ever removed.

All this was to be seen in progress below Wisbeach and Long Sutton Bridge, and the impetuous outfall of the water in the recess of a spring tide had forced its way through the sands in the beginning of August, 1830. With a view to this event, the old channel of the river Nene had been boldly dammed across in the middle of July, and the current turned into the straight cut prepared for it. All this constitutes the Nene Outfall. When I saw it meet the sea, four miles below the washway (now the drawbridge at Long Sutton) at three-quarters ebb, the torrent rushed down 4 ft. in the last quarter of a mile. This, of course, carries off the sand daily, and, by the law of nature, the 4 ft. fall will recede inland, until nearly a uniform inclination or slope shall penetrate to Wisbeach, which will become a seaport of importance; and, above it, 180,000 or 200,000 acres of fen land will retain nothing of its hitherto nature, except unparalleled fertility. (*Quarterly Review*, vol. lxiii. p. 450. No. cxxvi. March, 1839.)

From the above extract, the young gardener may learn to assign a scientific reason for straightening crooked brooks, when the object is to make them run quicker, or rendering straight ones circuitous, when it is desired to cause a rapid stream to be less so. By reflecting on the extract, he will find other matters from which he may benefit, but which, lest we should prevent him from seeking and thinking for himself, we shall not point out.—*Cond.*

*Warming and Ventilating.*—The Telford medal has lately been awarded to Mr. Charles Hood, F.R.A.S., for an article on this subject, of which an abstract is given in the *Athenæum* for July 13. The author, after showing the defects of iron stoves of every description, recommends, as the best mode of heating, steam or hot water in iron pipes. These are “more economical and simple, present greater permanence and equality, and a lower uniform rate of temperature, and admit of any form of heating surface. The temperature of the metallic surface rarely exceeds 180° Fahr., and never reaches 212°, which is too low to decompose in any appreciable degree the organic matter contained in the air. The only effect is to increase the capacity of the air for moisture, which is readily obviated. The surface which is intended to distribute the heat should be a good conductor and radiator, and the material which presents this combination in its highest degree is iron. The amount of heating surface which will be required depends on the building to be warmed, and on a great variety of circumstances; but, as an approximate rule, it may be said, that for a church or similar public building, the cubic contents of the building divided by 200, will give the number of feet of surface requisite for a temperature of from 55° Fahr. to 58° Fahr. in the coldest weather ordinarily experienced in this country. The form of the heating surface is immaterial as regards the

action of the apparatus; but the time requisite to obtain a given temperature, and the permanence of that temperature, depend on the mass of heated matter, the relative times of heating and cooling being inversely as the mass divided by the superficies." [The rule here given may safely be taken by gardeners as a guide for green-houses, but the heating surface will require to be increased a little for stoves.]

Ventilation is next treated on by Mr. Hood. "All air respired from the lungs is found to have lost a proportion of its oxygen, and to have acquired a proportion of carbonic acid gas and vapour, and the quantity of air which will require to be changed may be taken as  $3\frac{1}{2}$  cubic feet per minute for each person a room contains. The author dwells at considerable length on the physiological effects consequent on these changes, and details several striking instances of the great advantages resulting from improved ventilation, in places which had previously been unhealthy. All ventilation may be placed in one of two classes, the natural, or the mechanical; in the former, the excess of temperature of the air is the *primum mobile* of the efflux, and the rapidity of the discharge may be much increased by artificially raising the temperature of the discharging pipe. The ventilation by mechanical means, as by fans rotating with a great velocity, may be most advantageously employed wherever mechanical power is used for other purposes; the great efficacy of this latter mode is proved most unquestionably by the experience of the manufacturing districts. The former method has recently been tried on a very large scale at the House of Commons; and it is calculated by Dr. Ure that thirty-eight times more fuel is expended in producing the same effect by chimney draughts than by mechanical power. It appears, however, that the natural methods of ventilation, as by the spontaneous effusion of the heated air, through openings in the ceiling, is the best calculated for ordinary purposes, but in all extraordinary cases, ventilation by mechanical means is the only economical and efficacious method. (*Athenæum*, July 13. 1839.)

*The Method of heating Houses practised in Paris* seems to me worthy of being copied. Whatever be the weather, frosty or wet, the moment I enter one of the respectable cafés or restaurants, I find myself in a genial atmosphere. If this were only after nightfall, the lights would account for it, for they are brilliantly illuminated with gas; but it is the same at midday. In the very best London coffee-houses, the cheek of the fire is the favourite station, and winter reigns in the rest of the room. In the cafés here, there are no fires visible, but the stoves are so managed as always to maintain an agreeable warmth, and no place in point of comfort is preferable to another. In the hotels or lodging-houses, however, the case is the reverse. The *salle* for breakfast and dinner is heated with a fire of wood or coke, and has its torrid, temperate, and frigid zones. The bed-rooms and parlours, with their cold brick floors, marble tables, and a few billets of wood on the hearth, are dismal abodes for a person accustomed to large coal fires. (*Scotsman*, Jan. 19.)

Such is the high price of fuel in Paris, and on every part of the Continent, and such the severity of the weather during winter, that probably no house can be heated to a comfortable degree without the aid of stoves; but, even with these, to insure their full effect, the construction of the open fireplaces would require to be totally altered. Perhaps the cheapest and most effective mode of doing this would be to place in them one of the American stoves, so strongly recommended by Cobbett. This stove, which is very well known to the ironmongers of London and Birmingham, and is figured and described in our *Encyclopædia of Cottage Architecture*, we would strongly recommend to gardeners who have cold comfortless rooms, and who are obliged to use wood or peat as fuel. — *Cond.*

*Prepared Fuel for Hot-house Furnaces, &c.* — In some parts of the country peat is compressed for this purpose, and Lord Willoughby de Eresby has recently taken out a patent for a peat-compressing machine, which will be found described in the *Civil Engineer* for August, 1839 (vol. ii. p. 283.). In others, where coal is scarce, cow-dung, loam, and small coal are mixed to-

gether, made into cakes, and dried in the sun; and in certain parts, particularly on the Continent, powdered charcoal and loam are made into bricks, and found to make an excellent slow-burning fuel. Lately, however, a patent has been taken out for mixing tar, blue or yellow clay, road stuff or pond mud, and small coal, and making the whole into bricks, and drying them; and the fuel so produced is said to give out a more intense heat than the best Newcastle coal. The proportions, according to the specification of the patent in the *Repertory of Patent Inventions* for August, 1839 (vol. xii. p. 101.), are as follow:—Clay 7, tar 2, small coal broken, so as to be in pieces not larger than  $\frac{1}{4}$  of an inch in diameter 8, road scrapings 3, in all 20. There is scarcely a gentleman's seat in which there is not a good deal of small coal wasted, and here is a hint by which it may be turned to excellent account.—*Cond.*

*Preservation of Kitchen-Garden Vegetables through the Winter.*—At Brethby Hall, in Derbyshire (see p. 449.), an abundant supply of healthy cabbage cauliflower, and lettuce plants was preserved through the severe winter of 1813–14, by the following means, related by Mr. Blaikie in the *Farmer's Journal*, January 31. 1814, and quoted by our esteemed correspondent, Mr. Samuel Taylor, in the *British Farmer's Magazine*, new series, vol. ii. p. 396. “His Lordship's gardener (Mr. Groves) has made it a practice, when the young winter and spring vegetable plants grow over-luxuriant in autumn, to pull them up and expose their roots to the vicissitudes of the weather for a day or two; he afterwards replants them in their former places, and, in some instances, when the weather has been very mild late in the season, he has repeated the operation a second, and even a third time; this practice stagnates the growth of the plant, hardens it, and invariably enables it better to withstand the severity of the following winter. To this practice, which was followed last autumn, Mr. Groves attributes his wonderful success in preserving the before-mentioned vegetables, while very few have survived in the gardens in the neighbourhood. (*Brit. Farm. Mag.*, vol. ii. p. 396.)

*Choice of Seed Corn.*—The following facts show that the seeds of the cereal grasses may be plump, solid, weighty, and abundantly farinaceous, and yet the vital principle in a great measure destroyed, or the embryo wanting or defective. A respectable and intelligent farmer, seven miles south-west of Edinburgh, at an altitude of about 700 ft., soil and locality dry, informs us that his oats were well filled, but not cut, before the frost set in last autumn; were ultimately well carried, and produced a fair sample, weighing 17 stones, and, after paying mill dues, left  $14\frac{1}{2}$  pecks of meal. Five weeks ago, he put 24 grains, the growth of two different fields, into two separate pots, and placed them in a favourable situation for germinating. The result was, that one of the pots braided 5 out of the 12 grains, the other seven, which is exactly one half of the grains sown. Previously to this trial, the gentleman intended sowing part of his farm with its own growth, which is his usual practice, but has now purchased all his seed oats from a more favourable climate. (*Scotsman*, April 3. 1839.)

*Electricity.*—All the phenomena of electricity, according to Mr. C. V. Walker, are contained in two propositions: “electricity attracts matter;” “electricity repels electricity.” With these, in order to explain the mutual repulsion of two negatively electrified bodies, some have been induced to unite a third, viz. “matter repels matter.” This third proposition Mr. Walker does not admit; he conceives matter to be so inert, that but for some cause, extraneous to itself, were any portion placed in any spot in the universe, in that spot would it remain for ever motionless and changeless; and he doubts not that future enquiries will enable us to conclude that this inertia of matter, in its fullest and most extended sense, pervades the universe; and that all the varied changes of place in the planetary system, and all the admirable mechanism which regulates the whole, owe their existence to the electric fluid alone, to that fluid which seems to him, as far as we yet know, to be repulsive of its own particles, and attractive of all else. With this view, on this basis, and in the true spirit of generalisation, tracing all the phenomena of nature as

dependent on the fewest causes, and detecting in these few the perfection of simplicity indissolubly engrafted on the grandeur of design, were the arguments followed out. They embraced the phenomena of bodies positively and negatively electrified. (*Proceedings of the Electrical Society*, as quoted in the *Lit. Gaz.*, April 6. 1839.)

*The Expression of Grandeur.*—The royal palace is the object which first and last fixes the traveller's eye at Stockholm. In every view of the city, this noble building attracts his attention from all other objects. Its chaste style unencumbered with unmeaning ornaments, as in our abortive attempts at Grecian architecture, its vast volume, its effect on the mind of the spectator as a grand object, an effect produced, no doubt, by the architect's skill in being simple, and not distracting the attention by superfluity of breaks and details in his masses, place this edifice among the few modern structures which have attained the end and aim of the art; the impressing the beholder with an unmixed feeling of grandeur. (*Laing's Tour in Sweden in 1838*, as quoted by the *Athenæum*, March 9. 1839.)

*Labour not hostile to mental Improvement.*—“Are labour and self-culture irreconcilable to each other? In the first place, we have seen that a man, in the midst of labour, may and ought to give himself to the most important improvements, that he may cultivate his sense of justice, his benevolence, and the desire of perfection. Toil is the school for these high principles; and we have here a strong presumption, that in other respects it does not necessarily blight the soul. Next, we have seen that the most fruitful sources of truth and wisdom are not books, precious as they are, but experience and observation; and these belong to all conditions. It is another important consideration, that almost all labour demands intellectual activity, and is best carried on by those who invigorate their minds, so that the two interests, toil and self-culture, are friends to each other. It is mind, after all, which does the work of the world; so that the more there is of mind, the more work will be accomplished. A man, in proportion as he is intelligent, makes a given force accomplish a greater task, makes skill take the place of muscles, and, with less labour, gives a better product. Make men intelligent, and they become inventive; they find shorter processes. Their knowledge of nature helps them to turn its laws to account, to understand the substances on which they work, and to seize on useful hints, which experience continually furnishes. It is among workmen that some of the most useful machines have been contrived. Spread education, and, as the history of this country shows, there will be no bounds to useful inventions.” (*Dr. Channing on Self-Culture.*)

This admirable pamphlet we think the Society for the Diffusion of Useful Knowledge ought to print, and sell for 1*d.* or 2*d.*, instead of a shilling, the very unreasonable price at present charged for it. — *Cond.*

*Temperance Societies.*—All over Asia, where wine and spirits are forbidden by religion or custom, we find recourse had to opium, which is certainly no improvement; and that the use of that drug has of late been rapidly increasing among the lower orders in Britain. Temperance societies are harmless if not beneficial manifestations of that excited moral temperament which at the present period characterises this nation. The upper classes have given up hard drinking, without the aid of such societies, and have had recourse to recreations more intellectual and more congenial to a social structure, in which females occupy a more important station. The fine arts, especially music, are very efficient antagonists of inebriety, and their influence is now descending to the lower orders. We hear of societies for promoting education and temperance, when the tendencies of society at large have set in irresistibly in their favour, and need no one's assistance. (*Quarterly Review*, vol. l*xiii.* p. 380.)

*Unity and Variety in Objects essential to Beauty.*—Unity is necessary, from the limited nature of the human mind, which can only see and understand one thing at one time; and variety is equally requisite, from the expansive nature of the mind, which can see and understand an indefinite number of objects, provided they are presented to it in succession. — *Cond.*

## ART. II. Foreign Notices.

## FRANCE.

*THE Billandean Cabbage, Chou de M. Billandean.*—The Horticultural Society of Paris appointed a committee on August 8. 1839, to examine and report on this cabbage, which is said to be so large that the chou cavalier is a mere dwarf to it. MM. Billandean are seedsmen in Paris, and they received a plant of this cabbage from a correspondent in the department of Deux Sèvres, where cabbage is much cultivated for feeding cattle. The specimen sent was discovered in a field among others; and, being remarkable for its large size, it was left for three years, and afterwards taken up and sent to Paris. It grew on a sandy soil, with a calcareous sand as a subsoil, and the water is found at the depth of  $2\frac{1}{2}$  ft. under it. No other variety of cabbage grows higher in this soil than 3 ft.; but the specimen of the chou de Billandean sent to Paris measured in height 10 ft. It begins to branch at 8 in. above the neck; the branches are 30 in number, the lower ones from 8 ft. to 9 ft. in length, divergent, recumbent, and curved upwards at the extremities. At the period of flowering, the principal shoot of each of these 30 branches subdivides at the summit into 20 heads of flowers, thus giving on the whole plant 40 spikes of seed pods. These pods do not differ from others, but the seeds are less round and more unequal in size. The leaves of the plant, the committee were assured, were from 5 ft. to 6 ft. in length, pliant, not curled, and resembling those of the cauliflower, but on a much larger scale. The plant was raised from seed along with others, and not from a cutting, as some have alleged. It is considered probable that this variety is a sport from the chou branchu de Poitou, of which the chou vivace de Daubenton is a sport. It resembles more the latter than the former; but it differs from both in being higher than the chou cavalier, while the chou branchu and the chou vivace are less large than the chou cavalier. M. Poiteau, who is now (Sept. 5.) in London, assure us that this account is not in the slightest degree exaggerated; and, as the seeds, no doubt, will be immediately exposed to sale, such of our readers as are curious in the culture of cabbage will soon have an opportunity of trying the chou Billandean in England. The report, which is drawn up by M. Poiteau, concludes with the following paragraph:—

“Do Varieties reproduce themselves from Seed? We might, and, indeed, we ought, to be asked, whether the seeds of the chou Billandean will produce plants resembling their parent. To answer this question, we must have recourse to experience and analogy, and say that in our own time there have been formed many tribes or varieties in certain families of vegetables, particularly among cabbages. Thus, the Brussels sprouts have not always existed; we have not always possessed so many varieties of broccoli; the branching balsam, the dwarf balsam, the branching China aster, and the dwarf China aster, are the fruits of modern culture, and form races which perpetuate themselves by seeds, the plants which produce these, being annually selected, or, at all events, those which appear to deviate from the approved variety are rooted out. In the same way, the varieties of domestic animals are preserved pure, by avoiding cross-impregnation, and giving them suitable nourishment, &c. The seed from a double dahlia will produce more double ones than that from a single dahlia. The dark brown nasturtium which we all know was produced accidentally from the yellow variety, reproduces itself and perpetuates itself by means of selecting the plants that are to bear seed. Curled parsley, which was not known in the time of La Quintinye, and curled Normandy cress, whose origin is still more recent, produce seeds nearly as freely as natural species; the Chinese haricot bean, a dwarf variety with yellow seeds, produces a branching variety with white seeds, which perpetuates itself by seeds. The Spanish haricot bean has given within these few years a two-coloured variety which reproduces itself from seed. We could cite many other plants of an origin more or less recent, that perpetuate themselves from seed by the means of annual selections; but here is enough to draw our conclusion, that

varieties often reproduce themselves from seed and from new races. Thus the cabbage of M. Billandeau, being a variety of extraordinary height and size, can, according to the course of things, reproduce seeds, perpetuate itself, and, by the means of successive selections, constitute at last a permanent race. (*Rapport, &c.*, p. 7.)

These remarks are worthy the attention of the thinking gardener. It appears to us, that it may be laid down as a general principle, that all varieties which originate in seed will propagate themselves by seed to a certain extent, whether they be annuals, perennials, or ligneous plants. Formerly it was generally believed that the seeds of an apple would produce nothing but a crab; but now every one knows that the seeds of any particular variety of apple will produce that variety; perhaps with some slight variations, or, perhaps, with one plant among many so far different as to constitute a new variety or subvariety; for all varieties originate in sports. Thus, among timber and ornamental trees, the seeds of the purple beech will produce plants with leaves all more or less purple; the cut-leaved common oak, and the cut-leaved or eagle claw maple, reproduce themselves; and we have no doubt, if the weeping ash, which is a female plant, could be fecundated by a male weeping ash, the produce would be chiefly weeping plants; but there being no weeping male, and the plants of the weeping ash, when they produce seeds, having been of necessity fecundated by an upright-growing male, the produce is partly weeping and partly upright. We found a proof of what we have stated respecting the oak, in a nursery at Dumfries, in 1831, as mentioned in a former volume; and other instances will also be found recorded in this Magazine, though we have not time at present to search for the references. These will be found in the general index which we are now preparing for the fifteen volumes of this work now nearly completed. — *Cond.*

*Varieties of the Vine.* — For several years past the Linnean Society of Bordeaux have been in possession of a field on the beautiful estate of Carbonnieux, belonging to two of its members, the Messrs. Bouchereau, for trying experiments on the vine. The numerous varieties of the vine which are to be found in this field proceeded at first from those which had been collected at the Luxembourg at Paris, by the naturalist Bosc. They have since been considerably increased by transmissions from all parts of the world where the vine is cultivated. At the present moment, the Duke Decazes, who reestablished the collection made by Bosc at the Luxembourg, has just ordered to be sent to him by the French consul at Malaga, M. Denion, a package containing 16 cuttings, with pieces of the old wood attached (*croisettes*) of the most celebrated varieties of the vine in that country. (*L'E'cho*, p. 23., Feb. 7. 1838.)

#### GERMANY.

*Pròtea Múndii* Klotzsch, in *Garten Zeitung*, 1838, p. 113., has flowered in the Berlin Garden; and a very beautiful figure of it, accompanied by a description in German and English, has been distributed by M. Otto. *Pròtea Múndii* was raised from seeds received from the Cape of Good Hope in 1835; but dried specimens had been sent many years previous to the Royal Prussian Herbarium by the late Mr. Mund of the Cape, after whom the plant is named. This species belongs to those proteas which frequently flower freely the next year after sowing; such as *P. longiflora*, *compácta*, *mellisera*, &c., and therefore M. Otto strongly recommends it as an ornamental green-house shrub. It grows to the height of 5 or 6 feet, but bears pruning well, and may be kept as low as can be desired. It thrives in sandy peat, and may be propagated by cuttings of the young wood in sand under a bell in the shade. If not already introduced into England, it doubtless soon will be. — *Cond.*

#### INDIA.

*The Botanic Garden at Calcutta*, according to a writer in the *Magazine of Natural History*, vol. iii., new series, p. 304., is sunk into a state of rapid decline. "While the home and local governments evince the greatest anxiety to promote science and spread the light of knowledge over India, while

through their fostering care, several scientific institutions have of late sprung up in India, it remains an enigma how one of the oldest and most useful institutions should have been allowed to sink to its present state, which hardly justifies the application of the epithet 'botanical' to the garden."

"On entering the garden, the eye is struck with all the grandeur of an Indian vegetation. As a pleasure-ground, laid out in tolerably good taste, and kept in exemplary order by some 150 workmen, a more beautiful spot could hardly be found. But now, you stop before the nearest tree, and are desirous of ascertaining its name, its properties, its habitat. You ask, of course, for a catalogue; there exists *no catalogue* of the Honourable Company's 'botanical' garden!"

"To find out the plan upon which this garden is arranged amounts next to an impossibility.

"This establishment, forming a no small item in the Company's annual expenses, ought to prove of some little use to the public, particularly now that Calcutta boasts a medical college for natives. How far the students can study botany in a 'botanical garden, without *catalogue, herbarium, artificial or natural arrangement*, is unnecessary to speculate upon; it would be a more desirable topic for speculation, to point out the most expedient manner in which this fallen, but still noble, institution might, instead of proving, as it of late has done, a *bar* to science, be restored to its original purpose, which the liberality of its supporters and the public at large have a right to expect; viz, that of promoting science, in short, that of being a *botanical garden*." (*Mag. Nat. Hist.*, vol. iii., new series, p. 306.)

### ART. III. Domestic Notices.

#### ENGLAND.

*M. POITEAU* and *M. Tripet-Leblanc* from Paris have lately visited London, and the gardens in the neighbourhood. *M. Poiteau* is a celebrated botanist and horticulturist, who has been employed by the French government, in South America and other parts of the world; and who has for many years been the joint editor, with *M. Vilmorin*, of the *Bon Jardinier*. He is also the most active writer connected with the Horticultural Society of Paris. He excels in physiological knowledge, in which if he is equalled, we do not suppose he is surpassed, by any practical man in France; in proof of which we need only refer to the papers by *M. Poiteau* in the *Annales*. As an individual he is highly intelligent and benevolent, reminding us, in these respects, of the late much and justly respected *André Thouin*, whose pupil he was. *M. Tripet-Leblanc* is reputed the first grower of tulips in Paris. He is successor to a family of the name of *Tripet*, who have been celebrated tulip-growers and florists for two or three generations. *M. Tripet-Leblanc's* list of tulips will be found in our advertising sheet. What may be the merits of his collection, as compared with those of *Mr. Groom* and of other florists in this country, we know not; but it is highly creditable to *M. Tripet-Leblanc*, to be desirous of knowing the practices and the collections of British florists. — *Cond.*

*City Gardens.* — In Angel Court, a little court off Skinner Street, are five small gardens, to houses chiefly occupied by persons connected with the printing-office of *Mr. Woodfall*. The gardens are from 15 ft. to 20 ft. square, and contain a number of showy plants, and some shrubs, all in a thriving state. Among the plants are the dahlia, mignonette, marigolds, thyme, sweetwilliam, &c.; and among the shrubs, lilacs, roses, and sweet briar. We have sent, through the kindness of *Mr. Charwood*, to each garden a packet of twenty Californian annuals, which, we have no doubt, being sown immediately, will stand the winter, and come beautifully in flower early in spring. — *Cond.* August 15. 1839.

*Large Trees at Brockley Hall, Somersetshire, the Seat of John Hugh Smyth*



*Pigott, Esq.* — Cypress (*Cuprèssus sempervirens*), 55 ft. high, 5 ft. 4 in. in girt, and 42 ft. round the middle of the branches. Oak, 70 ft. high, and 28 ft. 6 in. in girt; another, 71 ft. high, and 34 ft. 2 in. in girt; another, 72 ft. high, and 23 ft. in girt; and several others of the same height. Elm (*Ulmus campestris*), 95 ft. high, and 22 ft. 6 in. in girt; another, 94 ft. high, and 23 ft. in girt; and another, 96 ft. high, and 23 ft. in girt. Ash (*Fraxinus excelsior*), 60 ft. high, and 17 ft. 6 in. in girt; another, 60 ft. high, and 15 ft. 6 in. in girt; a great number about this size. — *J. H. S. P. Brockley Hall, July 27, 1839.*

*Large Trees at Tredegar, the Seat of Sir Charles Morgan, Bart., in Monmouthshire, and in the adjoining Vicarage Garden.* — The pollard oak on the lawn at Tredegar is singular, from the extraordinarily tortuous form of its branches. I regret to add that, though still standing, it has been shorn of many of its lower limbs, and has thus lost much of its beauty. In the vicarage garden at Bassalleg, which is divided from Tredegar Park by a sunk fence only, stood some trees, which, compared with the usual size of others of the same kinds, appeared to my limited knowledge to be so fine, that I take the liberty of sending their dimensions. One, a Lombardy poplar, stood in an open lawn; and, being wreathed with roses and honeysuckles amongst the branches which feathered to its base, in summer formed a beautiful feature in a scene of no ordinary attraction. The circumference of its trunk is 11 ft. 6 in. There is also a second poplar, 3 in. larger in girt; a tulip tree, 7 ft. 4 in.; and a Lucombe oak, 7 ft. 2 in. The tulip tree runs in a single stem for 8 ft., and then branches into limbs, one of which measured 4 ft. 1 in., and two others 6 ft. 3 in. each, in circumference. The Lucombe oak has a fine straight trunk, and is yearly improving. The circumferences were taken at between 4 ft. and 5 ft. from the ground. All the trees, I believe, were planted at the same time, and are of about sixty years' growth. There are likewise some fine sugar maples; but I have no memorandum of their size. — *Ellen Anne Leyson. 17, Pittville Parade, Cheltenham, May 11, 1839.*

*Trees blown down at Capheaton, Northumberland, the Seat of Sir J. E. Swinburne, Bart.* — I believe I have, in my communication, p. 119., underrated the age of the large trees, as they exceed a century by some years. The storm of the 7th of January, 1839, has done me irreparable mischief, and ravaged my woods sadly. I have lost nearly 600 trees, about 150 of them large timber trees, some very fine old favourites. A larch, with 100 ft. of measurable timber; an elm ditto, of 150 ft.; a beech, 10 ft. round, with immense limbs; and, in some places, two and three large trees standing together; and very large openings are made in the centre of the woods.

I have, as well as my gardener, endeavoured to recollect if we had ever observed the appearances in the silver fir which you allude to in your fourth volume of the *Arboretum*, p. 2333. No such thing have I observed; but the stumps of all the resinous trees cut down are always longer in decaying than those of other kinds, but nothing like growth or vegetation has been noticed. Their duration I attribute to the resinous sap coming out of the bark when cut, and forming a crust over it the first season, that prevents the wet going down between the bark and the wood (but it never, *here at least*, extends over the woody part), and prevents decay. I have often observed that, when a branch has been cut off any resinous tree, a considerable resinous exudation takes place, but no symptom of shoot or vegetation. What may occur in a warm climate, I do not pretend to say.

The torrents of rain that fell during the storm of the 7th saturated the grounds so much as to greatly increase the loosening of the roots, and consequently rendered the trees more liable to be blown down. This place is not on the banks of the Tyne, but quite inland, eighteen miles north-west of Newcastle, and about 600 ft. above the level of the sea. As an old planter, I have observed that, in this part of England, trees generally grow best on a sloping exposure to the north. — *J. E. Swinburne. Capheaton, Jan. 23, 1839.*

*Magnolia grandiflora var. exoniensis.* — Sketches of three remarkably fine standard magnolias, of the Exmouth variety, have been sent us by J. W.

Dickinson, Esq. They are growing in the garden of Mr. Carew, at Knightleys, near Exeter. They are respectively, No. 1., 21 ft. 9 in. high, with the trunk 3 ft. 10½ in. in circumference at the base, and the diameter of the head 26 ft.; No. 2., 21 ft. 9 in. high, with a trunk 4 ft. 4 in. in circumference at the base, and the diameter of the head 26 ft.; and No. 3., 30 ft. high, the circumference of the trunk 3 ft. 10½ in., and the diameter of the head 30 ft. Such noble trees of this species of magnolia are not, we should suppose, to be seen elsewhere in Devonshire.

*Paliurus virgatus*, raised from seed brought from Italy in 1826, and now 11 ft. 9 in. high, with a head 9 ft. in diameter, is now growing in the garden of Mr. Dickinson, at Knightshayes, near Tiverton. By the beautiful drawing kindly sent us, it appears to be one of the most elegant of bush trees. We are only sorry that we cannot afford to be at the expense of engraving it. — *Cond.*

*Cælebogyne* (from *cælebs*, unmarried, *gyne*, woman; male organs not discovered) *Aquifolium* Smith, *Euphorbiaceæ*. — This plant was discovered by Mr. Allan Cunningham in Moreton Bay, and sent to Kew in 1829; and a paper on it, by Mr. Smith of Kew, was read before the Linnæan Society on June 18. 1839, from which the following is an abridged extract. "A short time after their introduction the plants flowered, and, proving to be all females, they were naturally passed over as belonging to a dioecious plant until Mr. Smith's attention was particularly drawn to them by the fact of their producing perfect seeds. They have annually flowered and matured their seeds since; and, notwithstanding the most diligent search and constant attention, no male flowers nor any pollen-bearing organs have been detected. Young plants have been raised at different times from the seeds, and they bear so close a resemblance to their parents, that it is scarcely possible even to suspect the access of pollen from any other plant. (*Annals of Nat. Hist.*, vol. iv. p. 68.)

*The gigantic Clover* (*Melilotus arborea*, p. 300.) is now 4½ ft. high, and producing white flowers, and it still continues to grow fast. The side branches are 2 ft. 9 in. long, and many of them showing for bloom. The gigantic hemp and the flax (see as above) are also growing vigorously. Should horses and cattle not like the clover, either in its green or dried state, perhaps sprinkling it with salt or with lime water might have a good effect. — *H. Bawell, Gardener to Sir C. M. Burrell, Bart., M.P. Knepp Castle, Horsham, Sussex, August 8. 1839.*

---

#### ART. IV. *Retrospective Criticism.*

*THE high Keeping of the Sheffield Botanic Garden.* — In your notice of this garden, p. 455., particular reference is made to the mode of managing the labour of the garden, the number of men employed, &c. Lest there should be any misconception on this point, I shall feel obliged by your giving insertion to the following remarks. It is stated that the number of men employed in the ground is three. Although this is correct, it ought to be mentioned that, besides these, there are also three professional gardeners and a boy employed in the stoves, green-houses, flower-beds, borders, and herbaceous ground, &c., whose time is wholly occupied in these departments. The other three are garden labourers, two of whom are employed by the piece, and earn, on an average, 20s. each per week. Their business is to keep down the whole of the low grass, clip the edges of the walks, flower-beds, and borders of every kind throughout the garden, and to clean up and remove the grass. The third labourer is occupied in hoeing, raking, &c. In this way the labour is divided, and each labourer having a certain amount of responsibility devolving upon him, this operates as an inducement to exertion. By this arrangement a much greater amount of labour is obtained than would be possible, or even reasonable, to expect by employing professional gardeners at low wages.

The extent of the garden being 18 acres, with a range of grass 300 ft. in length, the narrowest part of which is 24 ft. in width, it will therefore readily occur to those who know any thing practically of the labour and attention required in a garden of this extent, even to maintain the appearance of order and neatness, that there can be but little leisure for the nicer operations of the art. Indeed, to render a garden of this extent what it should be, there ought to be at least double the amount of labour bestowed upon it. But, although the circumstances of the Institution have made it necessary to adopt this alternative with regard to labour, I wish distinctly to have it understood, that in such cases as ours, where the extent of lawn is considerable, I should on no account whatever think of employing professional gardeners in mowing, sweeping, hoeing, &c. Were there no other reasons for this preference, economy alone would be a sufficient motive.—*R. Marnock. Sheffield, August 20. 1839.*

*Cause of the Barrenness of the Hautbois Strawberry.* — Having seen a notice, p. 472., stating the probable cause of the barrenness of the hautbois strawberry, I beg to send you my opinion, or rather practice. Now, of those plants that are barren, neither their own pollen, nor the pollen of any other variety, will make the fleshy receptacle swell. The method I pursue in getting good crops of the hautbois is simply this: I make a plantation of them some time in August, from runners that have produced fruit, and when they come into flower, I go carefully over them, and pull up all those that show imperfect blossoms. They are distinguished at a glance. Those plants that will swell their fruit are full and plump in the centre, and of a fine yellow colour, while those that are barren have large petals, with a low centre and very meagre appearance. It must be kept in mind that the plants that have produced fruit will produce unfruitful runners, and that, unless fresh plantations are frequently made, the fruitful stools will become barren.—*Cotswold. Stroud, August 23. 1839.*

*Morus Arb. Brit., p. 1350.*—A few of the fruit of *Morus álba* are pleasant: say two dozen at a taste; more cloy the appetite, by reason of their sweetness.—*J. M.*

*Morus álba Arb. Brit., p. 1354.*—Dr. Franklin only recommended the establishment of a silk society from England, where he then resided as agent of the colony of Pennsylvania. The cultivation of silk is confined now to the northern states. The southern states neglect it almost entirely. I have urged attention to it, as a means of occupying the old and the young slaves, who are a great expense to their owners. A man or woman with only one arm could be profitably employed; nay, I have no doubt but that, in a period of twenty years, two persons each, with ten or fifteen slaves, commencing cotton-planting and the silk culture, the balance of profit would be in favour of the latter concern. Cotton requires a great capital, to purchase land and negroes, and prepare the land and the cotton for market. Silk requires but little capital, if the mulberry trees are at hand, and the returns are received in the course of the year. While the white mulberry trees or the *Morus multicaúlis* are growing, the worms might be fed on the leaves of the native *M. rùbra*, which I again say yields a very strong silk. Cotton is very variable in price, the upland species is now 6 cents per pound, while last year it brought 16 to 20. Silk is in great demand, and will continue to be. Several companies have been incorporated in the states north of the Potowmac, to cultivate silk, and to manufacture it; and one recently organised in the state of Delaware (adjoining and south of Pennsylvania), with a capital of 500,000 dollars. In five years after sowing the seed, the leaves may be used. Millions of white mulberry trees have been planted in the course of a few years past, and millions will be planted annually for years to come.—*J. M.*

*M. rùbra Arb. Brit., p. 1360.*—Silkworms feed and thrive well on the leaves of the *Morus rùbra*; and the experience of the people of Pennsylvania, before the American war, and of the silk society then in Philadelphia, proved that

very strong silk was produced by worms fed on them. I have seen many fragments of garments which were made of that silk. — *J. M.* (See *Congress Silk Manual*, for this and other facts on this tree.)

*Ulmus fulva* Arb. Brit., p. 1407. — I regard the inner bark of this tree as the first of demulcents. The late Dr. Strong of the American army informed me that, after the action with the Indians in August, 1794, the superiority of the mucilage from the bark, over poultices of bread and milk, and flaxseed, was fully established, in bringing on a good suppuration, and a disposition to heal in gunshot wounds. In bowel and catarrhal complaints it is excellent. In dysentery it acts like a charm in allaying the most distressing bowel pain. The tree abounds in New York state, and the bark ought to be introduced into British practice. I could say much more about it. — *J. M.*

*Juglans nigra* Arb. Brit., p. 1435. — The wood of this tree makes the most beautiful cabinetwork, and is now fashionable in Philadelphia, as it is often finely veined, and receives a polish equal to mahogany. The tree grows to a great height, and the trunk to a large size. A few years since, the trunk of one was shown in Philadelphia and other cities, "which grew in Chatanque co., New York, that measured 36 ft. in circumference; its height previously to branching was 80 ft.; the entire height 150 ft.; the branches were from 3 ft. to 4 ft. in diameter. Had it been chopped and split into firewood, it would have yielded not less than 150 loads, of a fourth of a cord each, the common produce of an acre of woodland; or, had it been sawn at a mill, 50,000 ft. of inch boards, worth, at the country price, 1500 dollars." (*The Exhibitor's Handbill.*) The bark was 12 in. thick. The part that has been preserved consists of the lower portion of its trunk, 9 ft. in height, and is entirely sound. It was excavated after great labour, circular seats placed round it inside, and a door made in it. — *J. M.*

---

#### ART. V. *The London Horticultural Society and Garden.*

Nov. 6. 1838. — *Ordinary Meeting.* The following objects were exhibited. From Messrs. Chandler and Sons, 18 varieties of the beautiful seedling Chinese chrysanthemums raised in Jersey. From John Luscombe, Esq., of Coombe Royal, near Kingsbridge, in Devon, specimens of the fruit of the lime tree produced at that place. They were accompanied by some clusters of Seville oranges, taken from a very old tree, protected by a wooden frame only; sometimes as many as 16 fruit are produced in a bunch; one of the oranges exhibited, the produce of a young tree, protected in winter by reeds, was rather more than a foot in circumference. From John Williams, Esq., of Pitmaston, near Worcester, specimens of seedling pears. One, "the Chaumontel swan's egg," was raised from the seed of the Chaumontel, impregnated with the pollen of the swan's eggs; it was a middle-sized obovate fruit, with a short stalk, a large open eye, a russet skin, and a rich sugary flavour. Mr. Williams stated that it bears well as a standard, and will be in season in the end of October; the tree grows with upright branches, like the swan's egg. The other was a very small roundish obovate pear, raised from the "seed of the green chisel and pollen of the poire d'Auch;" it does not appear to possess merit of the first kind, the flesh, though sugary, being rather gritty. Mr. Williams found it succeed admirably on a north wall, where it ripens about the end of September, succeeding the jargonelle. From Henry Crace, Esq., of St. John's Wood, some specimens of the Marie Louise and Duchesse d'Angoulême pears. Mr. Crace stated that he had gathered 2,200 fruit of the former from five small trees, and that he calculated 300 more to have fallen; he ascribed the productiveness of the trees, and the fineness of the fruit, to the roots of the trees being covered with dung and watered since the month of July.

Dec. 4. 1838. — *Ordinary Meeting.* There was read, a report upon the effects produced on plants by the frost which occurred in England in the winter of 1837-8, by the vice-secretary. The author stated that, in con-

sequence of the unusual severity of the season reported upon, he had applied to various persons resident in different parts of the country for information respecting the effects of the cold upon plants, as observed by them. After mentioning the circumstances under which each set of observations was made, and showing that while the thermometer fell as low as  $12\frac{1}{2}^{\circ}$  Fahr. below zero in some parts of Kent, it was not observed at Dublin and Kilkenny below  $20^{\circ}$  above zero, while in the Isle of Wight it fell to  $15^{\circ}$ , and in Cornwall to  $12^{\circ}$  above zero. The reporter proceeded to examine the results thus produced, firstly, in a tabular manner with reference to particular species; and secondly, geographically, by stating under separate heads, and in great detail, the effect of cold upon plants introduced to gardens from Australia, California, and Mexico, China, Japan, New Zealand, the West Indies, North America (excluding California and Mexico), the Himalayan Mountains, Cape of Good Hope, South of Europe, Levant, and North of Africa, with adjacent islands, and, finally, from Chile and similar South American regions. With reference to this interesting subject, the following statements were made:—

“Of Australian plants, none seem to have been able to bear so much as even  $+12^{\circ}$ , except *Billardiæra longiflora*, which is recorded at Glasgow to have borne  $-1^{\circ}$  at the foot of a south wall, and a *Eucalyptus*, called *alpina*, which escaped at Norwich; it will, however, be probably found that this circumstance is, in both cases, attributable to some unexplained cause. It, therefore, seems useless to attempt to naturalise New Holland plants in the midland and northern parts of England. On the coast of South Wales, where the thermometer did not fall below  $+15^{\circ}$ , *Leptospermum lanigerum* is the only species which appears to have survived; at Carclew, in Cornwall, where the climate is generally very mild, although the temperature is reported to have reached  $+12^{\circ}$ , almost all the New Holland and Van Diemen's Land plants either perished outright or were irrecoverably damaged; the only exceptions being *Acacia stricta*, affinis, *Sophora*, and diffusa, *Callitris cupressiformis*, *Corræa alba*, *Callistemon lanceolatus*, *Grevillea rosmarinifolia*, *Leptospermum ambiguum*, and *Sollya heterophylla*. It is only in some favoured spots, and in the mild climate of Ireland, that any considerable number of Australian plants have proved really hardy, and even in those places a great many species died.

“Upon the plants of New Zealand there is little to remark, except that there seems no probability of their (in many cases) acquiring a permanent station in these islands. *Phormium tenax*, the New Zealand flax plant, escaped in a swamp at Carclew, a circumstance that should not be overlooked by those who hope to make it a subject of common cultivation in the milder parts of Ireland.

“Of the natural habits of Chinese plants little is known with precision. Many, no doubt, are obtained from the northern provinces, where the winter cold is severe; and it is to be presumed that they are what we find hardy enough to sustain a temperature of  $-4\frac{1}{2}^{\circ}$ , or lower. Among these are especially deserving of notice the beautiful *Cunninghæmia sinensis*; *Amýgdalus pumila*; *Fraxinus lentiscifolia*, a forest tree of the most ornamental character; *Glýcine sinensis*; *Juniperus chinensis*, a valuable evergreen; the noble yu-lan, or *Magnolia conspicua*; *Kölreutèria paniculata*, a fine deciduous tree; tree peonies; *Taxodium sinense*; and the magnificent climber *Bignonia grandiflora*. Of the Chinese azaleas, *A. indica alba* proved the most hardy. One scarcely knows in what light to regard the unexpected fact of *Illicium anisatum* having escaped at Claremont, where it was exposed to a temperature of  $-12^{\circ}$ ; but it is worthy of notice, that *I. floridanum* is reported in so many places to be hardy, that no doubt can remain upon that point at least. The fact of *Pitòsporum Tobira* not having suffered in South Wales more than *Arbutus U'nedo*, is important, and renders it desirable that this handsome evergreen should become the subject of experiments as to its hardy qualities elsewhere. *Thèa viridis* stood where *T. Bohèa* was killed.

“Such Japanese plants as have been the subject of experiment have, in the greatest number of cases, afforded evidence that the vegetation of the colder

parts of that region is well suited to our own. If *Eriobótrya japónica*, *Ligustrum lúcidum*, *Laúrus Cámphora*, and some others, were unable to resist the winter, probably in consequence of their being naturally found in warm valleys, on the other hand, 13 or 14 other shrubs proved hardy, among which are the beautiful new species of *Clématis*; and even certain varieties of *Caméllia japónica* exhibited a power of enduring cold which could not have been anticipated.

“The species native to the Himalayan Mountains resisted the cold to so great an extent, that there can be no doubt of a large proportion of the vegetation of those northern parts of India proving hardy in England, Wales, and Ireland. This fact alone is of the highest interest, because there certainly is no country more accessible to us, or whose productions are more worthy of being imported, whether for their value as timber, their beauty and variety as forest trees, or their brilliancy as objects of ornament. The mere knowledge that the noble deodar cedar is capable of enduring the utmost rigour of an English winter is almost alone sufficient to compensate for the destruction produced by the frost among other plants. All the pines and firs appear more or less hardy, except *Pínus longifolia*, which is not a mountain species. *Benthámia fragífera*, although tender in the midland counties, appears at home in Cornwall and Devonshire; the beautiful *Bérberis*, many cotoneasters, a *Euónymus*, *Juníperus recúrva*, *Leycestèria formósa*, all the spiræas, *Vibúrnum cotinifólium*, and, above all, the magnificent *Rhododéndron campanulátum*, have to be added to our lists of common shrubby plants. *Clématis montàna* too proved so robust, that we have not only secured that addition to our climbing plants, among which variety is so much wanted, but there are well-grounded expectations of some of the many other beautiful species of the same genus still to introduce proving equally suited to this climate.

“With regard to the plants of the south of Europe and adjacent countries, some facts prove new, others confirm opinions which were not previously established to the satisfaction of every one, and a few are inexplicable upon any known principle. That *Aristolòchia sempervirens*, a native of Candia; and *Péganum Hármala*, a common Syrian plant; *Ilex baleárica* and *Búxus baleárica*, evergreens inhabiting the islands of Majorca and Minorca; *Juníperus Oxýcedrus*, quite a southern bush; and *Pistàcia Terebínthus*, which is not found wild north of the coast of the Mediterranean, should all have been found hardy, where such plants as the tamarisk, *Arbutus Uñedo*, and the cypress perished, are results which could hardly have been anticipated. They are, however, of the first importance, because it will induce the more general cultivation of those among them which are beautiful. It is interesting to know that *Arbutus Andráchne* is more hardy than *A. Uñedo*, a fact which may perhaps be connected with their very different localities when wild; the former being exposed to the severe cold of south eastern Europe, while the latter, although wild in Ireland, is more peculiar to the west of Europe. Connected with this is the important fact, that *A. Andráchne* inarched upon *A. Uñedo*, in which condition it is usually sold in the nurseries, is unfit for planting, because of the tenderness of its stock. By taking care that plants of *A. Andráchne*, and also *A. híbrida*, are on their own roots, two fine evergreens may be considered secured to the gardens of the greater part of England. That there should be a variety of the olive hardy enough to bear  $-4\frac{1}{2}^{\circ}$  without the slightest injury, may be a fact of value to the olive-grower in many parts of Europe, and renders it probable that this useful tree may be profitably raised for its oil in any part of Ireland. To the fruit-grower the hardiness of the green Ischia fig is a valuable fact, for it will enable this variety to be cultivated much further to the north than it has hitherto been thought possible to possess figs as open standards. The Aleppo pine seems to have generally perished; but *Pinus brútia*, a Calabrian species very like in habit, seems to be hardy. There has been some difference of opinion as to the comparative hardiness of the species of *Cérasus* called “laurels” in this country. The fact is now established beyond doubt, that *C. lusitánica*, the Portugal laurel, is much

more hardy than *C. Laurocérasmus*, the common laurel. This could not have been expected from what are reported to be the natural habitats of those two species; the former inhabiting the mountains of Portugal and Madeira, where the climate is softened by the mild air of the Atlantic, and the latter being found on the mountains of the most eastern parts of Europe and of Persia, where the winters are more rigorous than in western countries. The death of the sweet bay and the laurustinus, on the other hand, corresponds with what might be anticipated from their inhabiting only the warm rifts of calcareous rocks in the south of Europe, where, if their branches are ever killed, their roots are secured against all chances of destruction.

“On Cape plants there is little to observe further than that all the shrubby species are evidently too tender to deserve cultivation, without protection, north of Cornwall and Devonshire. It is, however, satisfactory to find that the hard-skinned Cape bulbs and tuberous pelargonias will live in the open border, with only the aid of a covering of fern leaves, provided the border is well drained; and the undoubtedly hardy habits of *Aponogèton distàchyon*, and *Richàrdia africàna*, have secured to us two additional handsome aquatics.

“The low southern latitudes of South America have furnished a few accessions to hardy collections, among which the *Araucària Dombèyi* is the most interesting for the possessors of parks and large gardens, and it has now become an object of some national importance to procure supplies of seeds of this plant from Valparaiso; for to introduce in abundance so remarkable a vegetable production as this when old, with columnar trunks often 100 ft. high, surmounted by a pyramid of its grotesque branches, would be an object scarcely less than national, even if the plant did not furnish excellent timber, and an abundance of valuable resin. It also appears that *Aristotèlia Mácqui*, and the *escallonias*, *rùbra* and *glandulòsa*, all beautiful evergreens, are about as hardy as a laurustinus, that the graceful little *Berberis empetrifolia* is regardless of cold, and that *Collètia hòrrida*, *Duvaúa ovàta*, and *Heímia salicifolia*, also seem likely to bear this climate.

“Of Californian and Mexican plants, the former prove more tender than those from Mexico; a circumstance doubtless to be explained by the Californian species having been taken indiscriminately from warm valleys and mountain sides, while no one has thought of naturalising any Mexican species except from the cold mountain ridges. All the beautiful pines and firs from these regions, of whose habits so little was previously known, prove to be hardy wherever they have been tried, with the exception of *Pìnus insígnis* and *P. leiophýlla*.

“The winters of North America are usually so rigorous north of the districts warmed by the Gulf of Mexico, that to state that a plant is from the United States, is usually equivalent to saying it is hardy. There are, however, some exceptions to that rule, and it is requisite to possess the experience of such a winter as this, in order to judge whether the plants from British possessions on the Pacific would be as hardy as those from the Atlantic side of the Rocky mountains. The latter seems now to be well established, for of all the numerous valuable plants introduced by the Society from North West America, not one of any importance, with the exception, perhaps, of *Arbutus procèra*, proved tender; and, what is of the utmost practical importance, it is now clear that *Abies Douglàsü*, a species which grows as fast as the larch, has much better timber, is evergreen, and reaches an enormous size, is perfectly suited to the climate of Great Britain. *Yuccas* also resisted the frost so very generally, that they may be safely introduced into gardens as hardy endogenous shrubs; and the same observation applies to *Vaccínium ovàtum*, one of the handsomest of evergreens.”

The author next proceeded to advert to the singular fact, that in those places where the cold was very severe the more plants were exposed the less they suffered, and vice versa. This he explained upon the supposition, that in warm places vegetation had already made some progress, and plants were stimulated prematurely into growth, their stems were filled with fluid, and

they were, in consequence, affected by frost in a much greater degree, than when, from the coldness of a station, they were kept in their ordinary winter condition.

The temperature of the earth at different depths, during the prevalence of the frost, was mentioned as explaining why so many trees that had been killed to the ground were afterwards observed to spring up again. In the Society's garden two thermometers were buried in the earth, one at the depth of 1 ft., the other at the depth of 2 ft., and their indications were noted daily, when it was found that the ground was never frozen to the depth of a foot, even while the temperature of the surface was as low as  $4\frac{1}{2}^{\circ}$  below zero, and that it did not fall to within  $5^{\circ}$  of freezing at the depth of 2 ft. during the same period.

The last subject which had engaged the author's attention was the physical effect of extreme cold upon plants. After noticing the opinions upon this subject, given by Professors Göppert of Breslau and Morren of Liège, and describing various observations which he had himself made, he arrived at the conclusion, that the more important phenomena connected with the action of extreme cold upon plants consist in the distension of cellular succulent parts, often attended by laceration, and always by a destruction of irritability; the expulsion of air from the aeriferous passages and cells; the introduction of air into parts intended exclusively to contain fluid; a chemical decomposition of the tissue and its contents, especially of chlorophyll; a destruction of the vitality of the latex, and a stoppage of the action of its vessels; and, finally, an obstruction of the interior of the tubes of pleurenchyma, by the distension of their sides.

This report was stated to contain observations upon between six and seven hundred species and varieties.

The following objects were exhibited: — From Mr. John Green, gardener to Sir Edmund Antrobus, Bart., a cucumber, and several very fine greenhouse plants, among which was a beautiful plant of *Lucilia gratissima*. This charming species, whose perfume is of the most grateful kind, and whose broad heads of flesh-coloured flowers rival those of the hydrangea, was imported some years ago, but has gone very much out of cultivation in consequence of an erroneous statement that it is hardy. That is not the case, nor was it ever probable that the plant would bear an English winter, for it is only on the smaller and lower mountains of Nepal that it is met with in a wild state; as on the naked rocks of Nag-Urjoon, Bechiako, and Koolakan, and on the Pundua hills on the frontier of Sylhet; in those places it is said to form a tree from 16 ft. to 20 ft. high, with a stem 6 in. in diameter. As it flowers all the year round, this is a most desirable plant for a conservatory, or as a shrub of the open border, during the warmer months of summer.

From Mr. Peter Don, Gardener to James Bateman, Esq., specimens of four kinds of epiphytal Orchidææ; viz. 1. a new species of *Maxillaria*; 2. *Bolbophyllum caseum* of Manilla, a little brown-flowered species, named from its smelling strongly of cheese; 3. *Lælia albida*, a new Mexican plant, with flowers rivaling the cowslip in their fragrance; and, 4. the rare and beautiful *Epidéndrum Skinneri*. Concerning the latter, Mr. Bateman communicated the following note: —

“The exquisite beauty of the flowers of *Epidéndrum Skinneri*, and the season at which they are produced, render the plant one of singular interest to the lovers of Orchidææ; unfortunately, however, it has universally been found extremely difficult to manage. Its flower-spikes, it is true, were always forthcoming, even from the weakest shoots, but the number of flowers which they bore grew less and less each successive season, until at length in too many instances the plant perished altogether.

“The cause of this ill success in its cultivation was obviously owing to the difficulty in preserving its thick fleshy roots from decay; for many were uniformly lost if the plant was kept in a high and damp temperature, or if they



came in contact with the masses of turfy peat, in which the majority of Orchidææ thrive. Having learnt from Mr. Skinner that the plant was usually found at a considerable elevation, and remembering those very plants, when first imported, were quite interwoven with a number of thorny twigs, I determined to try whether by placing a plant of the species for half the year in a vinery, and attaching it to a sort of basketwork formed of small oak branches, I could not restore it to its pristine health. The spike now sent for exhibition, which is double the strength of the one which the same plant produced last year, is the happy result of my experiment."

From M. René Langelier, nurseryman at St. Heliers, Jersey, a collection of pears, upon which the following note was made by Mr. Thompson. The most important variety in this collection is a pear called Van-Mons Léon-Leclerc, raised by M. Léon-Leclerc, of Laval. It is a fruit of an oblong form, about 4 in. in length, and nearly 3 in. in diameter. The eye is shallow, small, but open; the stalk rather more than 1 in. in length, moderately strong, and inserted obliquely; the skin yellowish, everywhere profusely sprinkled with brown, which near the stalk amounts to a sort of russeting. The flesh is yellowish white, buttery, and melting, with a very rich sugary flavour. It proves a pear of first-rate excellence, combining the properties of large size, handsome appearance, and rich flavour. Should it attain equal perfection in this climate, it will be surpassed by none in its season, which will probably be the beginning of December. The *Fortunée Belge* is the same as the *Fortunée de Parmentier*. The *Beurré d'Aremberg* is the *Glout Morceau*, and this is the case with this sort in the Jersey collections very generally. *Beurré magnifique* is the *Beurré Diel*. *Belle de Jersey* is the *Uvedale's St. Germain*. *Epine d'Hiver* is false, and proves the *Bergamotte de Pâques*. *Délices d'Hardenpont* is different from the various sorts which have, perhaps, incorrectly borne that name in the collection hitherto received by the Society; it partakes much of the nature and appearance of the *Doyenné blanc*, from which it has probably originated, as many other varieties appear to have done, some of which (as the *Colmar Neill*) even surpass the above newly received sort in flavour. *Mollet's seedling Chaumontel* bears considerable resemblance to the old *Chaumontel* both in appearance and flavour.

*January 15. 1839.—Ordinary Meeting.* A communication was read from Sir George Stuart Mackenzie, Bart., upon the result of some experiments he had made upon the cultivation of the potato. The first experiment related to the difference in productiveness between the point, the middle, and the base of a potato. Three different varieties were taken, and every eye but one was carefully removed from the sets. The results were, —

	Point.	Middle.	Base.
No. 1. produced	4 lb.	4 lb. 6 oz.	3 lb. 8 oz.
2. produced	5 lb.	6 lb. 3 oz.	3 lb. 8 oz.
3. produced	5 lb. 8 oz.	7 lb. 8 oz.	7 lb. 8 oz.
Total	14 lb. 8 oz.	18 lb. 1 oz.	14 lb. 8 oz.

It, therefore, appeared that eyes from near the point and base of a potato should be rejected by the planter, and the middle eyes only used. In another experiment, exactly the same quantity of the tuber was taken with a scoop, from each of the above three sorts, so that each set formed a hemisphere of about half an inch in diameter. Under these circumstances, No. 1. yielded 4 lb. 9 oz.; No. 2., 2 lb. 4 oz.; the result of No. 3. was considered doubtful.

*Exhibited.* From the Hon. W. F. Strangways, cones from Naples of *Pinus Pinaster*, máxima, and minor. One of them belonged to the plant considered by Italian botanists to be the true *Pinus Pinaster*, while that cultivated in England, an intermediate variety, has been considered the *Pinus maritima* of *Duroi*, and hence two supposed species have been created out of one. It appears, however, that M. Tenore, who sent the cones to England, is now aware of all the forms really belonging to one species.

From Mrs. Randolph, of 2. Bridge Street, Westminster, specimens of artificial flowers prepared from feathers of the natural colour. These were singularly well executed imitations of flowers, the brilliancy of the colours being quite equal to those of natural specimens.

From Petty Vaughan, Esq., a small collection of apples grown at Hallowell, Maine, United States, in about  $44\frac{1}{2}^{\circ}$  N. lat. Some of these specimens were not so large as they are sometimes produced in America, but their colouring indicated a much greater degree of sun heat than has been experienced of late in England. Of those in the collection the Boston russet proved a good apple in this country, and the Rhode Island greening also succeeds well. The Newtown pippin is sometimes good in warm seasons and situations; but more frequently its character becomes so much altered, that it is difficult to believe it the very same variety as the imported fruit.

*Feb. 19. 1839. — Ordinary Meeting.* Read, a letter to the secretary from Mr. W. B. Booth, upon the mode of constructing wire fences for training espalier fruit trees upon, and for other purposes.

*Exhibited.* From Mr. Beaton, gardener to Thomas Harris, Esq., a very remarkable collection of cactaceous plants, chiefly imported from Mexico and the Spanish Main; also a fine crimson-flowered inga, and two specimens of a *testudinaria* from Mexico. Among the former plants was *Cereus senilis* of various lengths, from a seedling 2 in. high, and supposed to be eighteen months old, to 5 ft. 3 in.; and it was mentioned that the Duke of Bedford had recently received one of these plants 7 ft., and two others 10 ft. long each; others were said to be expected as much as 14 ft. long, and of a woolly as well as hairy appearance. Connected with this collection the following note from Mr. Beaton was read to the meeting:—

“At a meeting of the Horticultural Society, held on the 19th of June, 1838, I exhibited a collection of *Cacti*, amongst which were two or three seedlings which I thought at that time were those of *Cereus senilis*, having raised them from seeds received under that name from Mexico, but I have since ascertained they were those of a species of *Echinocactus*. It will be recollected by the Horticultural Society that those seedlings were destitute of the hairs peculiar to *C. senilis*, which gave rise at the time to an opinion that the hairs were not produced on *C. senilis* until a certain period of its age, or, at least, not in the seedling state. I am glad to be now enabled to correct this opinion, by exhibiting a dried specimen of a seedling *C. senilis*, which I have received from Mexico, by which it will be seen that the hairs are produced in that species along with its spines in the seedling state.”

Cuttings of the following fruit trees were distributed:—

The winter crassane pear, an excellent bearer as a standard or dwarf. The Shobden Court pear, a variety raised by the late president; it possesses a flavour partaking of that of melon and pine-apple. The royal hâtive plum. This sort resembles the reine Claude violette in appearance and high flavour, and ripens considerably earlier. Knight's large green drying plum, a sort as large as the Washington, and superior to it in point of flavour; it fruited for the first time last season; its merits as a preserving plum are not yet known, but as a dessert fruit it will doubtless rank high.

*March 5. 1839. — Ordinary Meeting.* Cuttings were distributed of the following fruit trees, viz.:—The Reine Claude violette plum; one of the few purple plums of which the flavour will bear comparison with that of the green gage. The nelis d'hiver pear; not a large sort but high-flavoured, syn. la bonne Malinoise. The Louise bonne pear of Jersey; very different from the old Louise bonne of the French, which is quite worthless in this country. This will succeed as a standard even in the north of England, where it answers better as such than the Marie Louise; season October. The Downton nonpareil apple; larger than the old nonpareil, of a brisk, sharp, yet rich flavour; hardy and a good bearer.

*Ordinary Meeting. — March 19. 1839.* Read, a paper by Mr. Philip Con-

way, Gardener to Lawrence Sullivan, Esq., F.H.S., upon an improved plan of constituting Macphail's pits.

The most novel features in the plan were these: the pit is filled with blocks of wood to the height of 3 ft. 3 in.; and over the blocks is placed a layer 6 in. thick of fermented leaves, and upon the leaves the earth rests in which the plants are made to grow. The walls of the pit are hollow, and pigeon-holed from the bottom upwards to the height of the blocks of wood. The dung linings are applied externally in the usual way, resting upon the external pigeon-holes; the heat and moisture they produce pass into the hollow walls which they warm, and thence through the interior pigeon-holes to the blocks of wood, among which they circulate and finally rise into the mould through the layer of fermented leaves. The author stated that the effect of this plan was to produce a fine humid atmosphere, well suited to the growth of melons and cucumbers; and that the latter could be grown in such a pit successfully at the earliest seasons of the year.

*Exhibited.* From Mr. P. N. Don, Gardener to James Bateman, Esq., flowers of *Trichopília tórtilis*, *Epidéndrum crassifólium*, *Bonàtea speciòsa*, *Oncídium viperinum*, and *Dendrobium fimbriatum*; concerning the latter the following memorandum by Mr. Bateman was read:—

“*Dendrobium fimbriatum* does not receive half the attention it deserves, for I can truly say that as yet I have never beheld any species of the Orchidææ that produces such an overwhelming burst of beauty as itself. I have now about sixty bunches in the highest perfection on my plant, which is suspended from the rafters in a pot not more than a foot in diameter; the stems droop over the margin of the pot equally on every side, and the ocean of flowers that dangle at their extremities looks more like enchantment than reality. The plant never fails to flower, and its management is the simplest thing in the world, requiring merely to be removed to any dry cool place (I believe a common living-room would answer every purpose) during the winter months, and to have plenty of heat and moisture during its season of summer's growth. It may be retained to a longer or shorter period in its winter quarters, according to the season when you wish it to produce its flowers, for they will begin to make their appearance immediately after its translation from a cool place to a warm.”

*April 2. 1839.— Ordinary Meeting.* From Messrs. Ross and Co., 33. Regent Street, London, specimens of India rubber bags to preserve cut flowers. These bags are fitted with a self-acting spring, which keeps the end closed up; and, in consequence of their sides not allowing the water evaporated from the flowers to escape, they will for a long time prevent their fading and withering. From Mr. Butcher, gardener to Mrs. Lawrence, a collection of stove and green-house plants, among which were eight species of Orchidææ, and the rare *Adánia cyànea*, a Nepalese shrub, whose fruit is a cluster of light blue berries. From the garden of the Society, several green-house and other plants, among which were *Oncídium stramineum*, a very rare Mexican orchidaceous plant, received from Mr. Hartweg; *Chorózema Dicksoni*, a new and handsome Swan River papilionaceous shrub, with deep red flowers; and *Trymàlium odoratissimum*, a sweet-scented shrub, with loose panicles of small white flowers, also from the Swan River.

*April 16. 1839.— Ordinary Meeting.* The following paper was read, in explanation of the manner in which the forced strawberries, for which a silver Banksian medal was awarded at the meeting on the 2d inst., were obtained; by Mr. Robert Errington, gardener to Sir P. de M. Grey Egerton, Bart., M. P., at Oulton Park, in Cheshire.

“The runners I use are obtained from the forced plants of the previous season. For this purpose, I reserve all the best pots when they are taken out of the house after gathering the crop, and by sheltering them in frames for a few weeks, so as to preserve and ripen their foliage, they produce both fruit and runners in abundance in September.

“After a few weeks' protection, they are turned out of their pots into rich

soil in the course of the month of May, by which time the growing principle is stopped; and it may be observed, that the circumstance of taking them out of their feeders, or pans, which had become full of their fibres, combined with the drop of temperature they sustain in their removal from the houses to the cold-frame, is sufficient to put them instantly to rest, and bring on an artificial winter; as far as the maturation and rest of the newly organised bud is concerned. The runners are taken from the plants in the autumn, and planted in a reserve bed as thick as they can stand together for the winter. I must here digress to observe that the advantage which the runners of forced plants possess over the common garden runners is twofold. In the first place, the runners of the forced plants being produced later are smaller, and much less disposed to blossom, consequently have more of the growing principle in them; and are, in my opinion, more analogous to a seedling; and, secondly, in point of size, for the plant cannot be too small, if it have a leaf and a root. In the beginning of April I prepare ground for their reception and cultivation. I choose my ground in the lightest and most exposed situation which the kitchen-garden affords, in fact there must be no shade of any kind near them, the ground must also be solid, that is to say, ground which has not been stirred for months; my object being to produce early growth, early rest, and a fibrous surface root. The ground is dressed with the rottenest dung the place affords, well mixed in with a fork about 4 in. deep (by no means more). I place the runners in lines 20 in. apart, and allow 18 in. between plant and plant in the row. Nothing now is requisite but to keep them clean through the summer, well-watered for a month or so, and to cut away all runners and blossoms as they appear. In the middle of August, by which time they are strong plants, I commence a series of checks, intended to drive the plant into an early and decided rest. A labourer with a spade cuts within a foot of the plants all along the row on both sides. If this does not cause them to flag in a hot sun, the cutting is repeated in a week, and perhaps a third time, cutting nearer the plant each time, until finally within 6 in. However, be it understood, the extent of this checking process depends entirely on the character of the summer, and the state of the plant. If a hot dry summer, perchance they may not require it; but, for early forcing, the plant must be got to rest early in the autumn, and by rest I mean the entire ceasing of the production of young leaves in the heart of the plant, and the browning or spotting of all the larger leaves.

“In the early part of September, I pot them in what is called about London the No. 24. I reduce the ball of earth very liberally, and trim the roots in with a knife. The pots are drained with a mixture of old tan quite rough, half-rotten dung, and coarse sand. The soil I use is composed of three parts of yellow loam sod, almost as adhesive as clay, but mellowed with age, and one part of rich rotten dung, adding a good sprinkling of fine bone dust. As soon as potted, they are placed behind a north wall and sprinkled occasionally with water. They remain here about a week or ten days, in fact, until I can ascertain that they are making new roots; they are then removed to a hot gravel walk before a south border, where they remain till the last week in October. While in this situation, they are watered occasionally, but not too freely, just enough to keep them from flagging. In the end of October they are plunged behind a north wall completely in the shade, and from this moment I date the commencement of their winter; their large strong leaves are now of a coppery and mottled brown, and begin to drop down on the pots. In fact, every thing indicates the most perfect maturity of the bud. When I want to commence forcing, I move a portion of them into a slow moist frame heat of from 40° to 50°, and I may here observe that the more gradually they are started the better, but by all means in a moist warmth. When I perceive the flower-stem, I introduce them to the back shelves in the houses, placing roomy feeders or pans under them half-filled with the following compost: viz. three parts rotten horse dung, one part sandy loam, one part old tan in little knobs or lumps, two parts coarse sand; the pots being placed particularly firm and level on this,

little now is wanted but regular watering; the thermometer, however, is by no means allowed to rise above  $65^{\circ}$  in the day, and  $55^{\circ}$  at night, until the first bloom opens, except in sunshine, and the floors are kept saturated with moisture, with, at all possible opportunities, abundance of air. As to setting the blossoms, I endeavour to get the house up to  $70^{\circ}$  artificial heat, from daylight until near noon, by which time I have a perfectly dry atmosphere, and the farina in a most subtle state. I then open the sashes front and back, and obtain a lively circulation of air for an hour or so. I then take all the air away, and, towards three or four o'clock, syringe them over head, and water the floors and flues for the night. The next part of the process is thinning out the berries when they begin to swell off; my crops set so abundantly by the above method, that I am compelled to thin away at least one half with the scissors. I leave from 14 to 20 berries on each pot, and immediately this thinning is completed, I increase my heat to  $70^{\circ}$  by day, and  $60^{\circ}$  by night, shutting up the house on sunny days as high as  $90^{\circ}$ , with heavy syringing and floors saturated with wet. I use liquid manure from the time the first flower opens until the fruit turns colour, diluting it with one half clean water in a tepid state, observing to use clean water alternately with dung water, as I find by experience that it is absolutely necessary at all times, or stagnation ensues; and I may here observe that this is the reason why, as I think, many are deceived in their expectations with regard to liquid manure. When my strawberries are ripening, I withhold water almost entirely, more especially for many hours previous to each gathering, observing to give abundance of air by day, and, if possible, a little at night, as on this their flavour most materially depends. When they begin to colour, I lower the temperature of the houses, as the slower they ripen the finer the fruit will be, and the richer the flavour, taking care, however, not to starve them.

“Those who have not been accustomed to this mode, may probably be prejudiced at the appearance of so much care and trouble. I can assure them, however, that it is not so troublesome as it appears at first sight; it is only observing the proper times of conducting the different processes, which, if attended to, will infallibly produce abundant crops of unusually large strawberries. Of course no red spiders or aphides are allowed to rest a day on the plants, one complete fumigating and a day's sulphuring, when the blossoms of the earliest crop are rising, are all the care I take in this respect; and this carries me through the strawberry season. I send herewith a dozen specimens gathered from my second crop.

“I have two houses in which I grow them, each 30 ft. long; they are placed on a back shelf close to the roof; each house holds 32 pots, heated by hot water, and the roof is metallic.

“One fire heats three 30 ft. long houses, whose bases respectively are 18 ft., 16 ft., and 14 ft. in width; they were built and heated by Mr. J. Jones of Birmingham.

“The following is a statement of the produce of the two shelves. Each pot averaged 14 strawberries; each shelf contained 32 pots. From 3 to 4 strawberries averaged an ounce, the largest strawberry weighed an ounce. Thus  $32 \times 14 = 448 \div 4 = 112$  oz. the produce of each shelf.

“Which, at 2s. per ounce, gives £11 4s., or the two shelves £22 8s.

“I may here add that the first crop is now gathered, the plants turned out, and another set of strong plants introduced, which are now in bloom.”

*Exhibited.* From the Rev. Thomas Garnier, cones of *Abies Webbiæna*, ripened in his garden at Bishopstoke, near Winchester. From Mr. Errington, gardener to Sir P. de M. Grey Egerton, Bart., a dish of strawberries forced in the manner detailed in the foregoing paper. From Mr. Pratt, gardener to William Harrison, Esq., a plant of the rare *Arctostaphylos myrtifolia*, together with *Euphorbia splendens* and *Peristèria péndula*. From Mr. D. Beaton, gardener to Thomas Harris, Esq., a specimen of *Clerodéndrum phlomoides*, a rare stove plant, with fragrant white flowers.

ART. VI. *Biographical Notice of William Watt, Gardener to the Earl of Buchan about the middle of the 18th Century.*

I BEG leave to send you a short biography of William Watt, who, many years ago, was gardener to the late Lord Erskine's father, at that time called the great Earl of Buchan, at Kirk Hill, Linlithgowshire. Watt entered into His Lordship's service at Martinmas, 1739, nearly one hundred years ago. In May, 1744, he told Lord Buchan that, as he had never worked as a journeyman in Scotland, he meant to go to England to improve himself. His Lordship told him that it was folly to do so, for that he (Watt) was considered the best grower of melons in all West Lothian. Watt, however, persisted in leaving his place at the following term, Martinmas; and on that day Lord Buchan went to the garden, and told Watt that he requested him to dine at his own table that day, when he would pay him his wages. Watt made reply, that it did not become him to sit at His Lordship's table, and requested to be excused. Lord Buchan rejoined that he (Watt) was not then His Lordship's servant; and, consequently, if he (Lord Buchan) thought proper to ask him, he was as fit a companion for his table as any one else that he chose to invite; and so he would take no excuse. After dinner, Watt received four years' wages, he having only drawn one year's salary in the five years' service. The money due to Watt was sixty guineas, being at the rate of fifteen guineas per annum. Fifteen guineas were paid him, and a letter given him to draw another fifteen from a friend of Lord Buchan in London, in case Watt should be robbed while travelling on his way, as he journeyed on foot. His Lordship made Watt promise to return at the end of three years to be his gardener again, and they agreed that each of them was to write to the other twice in each year, for the three years of Watt's absence.

At the end of two years and a half, Watt received a letter from Lord Buchan, reminding him to be home in November, according to agreement. When Watt was reading the letter, the gentleman in whose garden he was then working came up to him and said, "Well, my lad, you are reading a letter." Watt said, "Yes; it is from my old master in Scotland;" and gave it to him to read. When the gentleman had done so, he said, "Your old master has a great regard for you;" and desired that so long as Watt remained in his service, which was six months, he should have sixpence per week over his regular wages, and his dinner every Sunday; although he would not give a tankard of ale when a tenant paid him 300*l.* of rent. Watt returned at the appointed time, and continued in His Lordship's service many years, indeed, till the establishment was broken up. He then became gardener to the University of St. Andrews; and I was the last apprentice he had. He died in 1798, in the 83d year of his age. — *James Dall. Newmarket Road, Cambridge.*

---

ART. VII. *Obituary.*

DIED, August 27., at his residence in Garden Row, Kilkenny, *John Robertson, Esq., F.H.S.*, the much respected nurseryman of that place. Mr. Robertson was the author of several valuable articles in the *Transactions of the Horticultural Society*, and in the *Gardener's Magazine*. "He was respected by all classes, and beloved by the poor and destitute, to whom he was a most liberal benefactor." (*Kilkenny Moderator*, August 28.)

---

THE  
GARDENER'S MAGAZINE,

NOVEMBER, 1839.

---

ORIGINAL COMMUNICATIONS.

ART. I. *On the Kyanising Process, and on other Modes of seasoning Timber.* By JAMES MONRO, Forester to the Marquess of Northampton.

THE premature decay of timber, and especially of the oak, by what is technically called the dry rot, is a subject which has occupied no small share of public attention. If we may credit all that we read and hear, the immersing of timber in Kyan's mercurial preparation is the nearest approximation to the long wished for desideratum. Still I cannot conceal my doubts as to its general utility. Its application to timber for lighter purposes may be of much use in promoting durability; but its action on the huge timbers of even a third-rate man of war will, I fear, come infinitely short of expectation: and, indeed, I think it highly probable that after-experience will prove that, from the claims of a decided specific, Kyan's process must degenerate to the rank of an expensive auxiliary.

In all our attempts to arrest the progress of dry rot, there seems to have been an obvious misdirection of enquiry; our investigations not having yet been directed toward the more immediate cause of the malady. In organic bodies preventives are always preferable to cures; therefore, wherever detrimental effects present themselves, we ought at once to turn our attention to the producing cause with a view to its removal, rather than to the application of temporary palliatives. That the appearance of precocious decay in manufactured timber may be traced to the presence of alburnous matter, in its fluid state, in the sap vessels, is a fact generally admitted. When an oak tree with its vegetative powers in full operation is felled, the sap, or alburnous fluid, not having been perfected, or converted by the process of foliaceous elaboration to its ultimate purpose, becomes stagnant; putrefaction speedily commences, and in a short time communicates with, and contaminates, the sounder parts of the fibrous column. The direct means employed by nature in decomposing vegetable matter does not appear to have received

its due share of consideration from the naturalist. The agency of alburnous matter in an imperfect state is allowed; but, judging from the analogy that subsists between animal and vegetable creation, we can only view this as a secondary cause. In all bodies, whether animal or vegetable, where vitality has ceased to exist, it seems to be a universal law of nature, in the process of decomposition, to employ some active foreign power. Self-destruction forms no clause in the natural code; therefore we may rest assured that there is something else in operation, than merely the presence of simple alburnous fluid. Animal bodies contain the seeds of corruption within themselves; the different fluids teem with countless millions of animated beings. When the vital functions are brought to a close, these tiny tenants of the veins and arteries commence the work of devastation upon the more assailable matter: the putrid mass engenders animals of larger dimensions, to gnaw the sounder portions of the frame, and, shortly afterwards, the loathsome task of uniting earth to earth is accomplished.

It is possible that the decomposition of vegetable substances is performed by means not very dissimilar to that of animals. The germs of the dry rot may be communicated to the fibrous mass through the medium of the secretive organs at the root. Doubtless, the alburnous fluid is tenanted by legions of animalcules, the putrid remains of which in the sap vessels may form a soil, or bed, for the developement of the embryo fungus. Immersion in corrosive sublimate imparts no additional strength to the woody fibre, it only destroys the vitality of the matter in which the dry rot originates; and, if the foregoing remarks on the origin of the malady are based in truth, then we have within our reach agents equally, or even more, effective, and far less expensive, than corrosive sublimate. If it can be clearly proved, that unconverted sap in timber is the source of the dry rot, as already suggested, then I have succeeded recently in the inventing of a process, whereby the sap can be completely extracted from logs of almost any size. By this process (the material for the preparing of which can be had for picking up any where) I find that oak timber can be divested of the sap, and so seasoned, that, in less than ten hours after being cut, it may be put into the hands of the carpenter. It was my intention to apply this process to preventing the shrinking and twisting of larch timber; but I have not had an opportunity as yet of making the experiment: from what I have seen of its effects on oak, however, I entertain the most sanguine hopes of success.

An aptitude to act on superficial evidence is a fault common to our nature; and hence we are too often led to mistake effect for cause. Precocious decay, or dry rot, is an effect, in my opinion, produced in most instances by the very questionable



manner in which oak timber is harvested. In felling most of the other species of hard-wood trees, it is an invariable practice to have them cut down when vegetation is in its most inert state; but, from the great value of its bark, the oak forms an exception to this most judicious rule. The process of disbarking can only be performed when vegetation is in full activity, and certainly it requires no argument to show that this, of all seasons in the year, is the most improper to fell timber of any sort, if durability is to be taken into consideration. Oak bark forms no contemptible item of our inland commerce; and to propose that all oak trees to be applied to marine constructions should be cut down in the months of December and January, will be a startling announcement to some economical proprietors and stewards, as by such a course the value of the bark must be sacrificed; but I propose no such thing to them. Let it be remembered that I am writing with a view solely to the stability of the wooden walls of old England. I am not patriot enough to recommend individual sacrifice for the public good, when there exists no necessity for it. This is the age of "compensation;" and when, collectively, we can afford to present the West India planters with twenty millions sterling for performing one single act of justice, surely, when treating with oak-venders to furnish our timber depôts with sound material, we can well afford to make an equitable allowance for the bark, if it can be proved, as I think it easily may, that we would be gainers thereby.

All timber, then, for the use of the British navy ought to be purchased growing, with an understanding between the contracting parties, that the vendor shall be bound to fell the trees at such seasons as may be agreed upon; namely, in the months of December or January. Had some such plan as this been adopted long ago by the officers of the public dockyards, it is my firm belief that dry rot would have been much less prevalent. Even the process of felling herein recommended is susceptible of improvement. Where any large oak tree fit for naval purposes is sold, it might be arranged that the purchaser should be allowed two, three, or more, years to remove it. In this interim, vegetation might be gradually retarded, by severing from the main root, annually, so many of the principal lateral roots, until the foliage all but refused to expand. Under this treatment the usual copious flow of sap would be diminished; and, by reducing the medium of its ascent annually, the fibre would become seasoned, and would acquire a rigidity and toughness not obtainable under the old regimen.

This idea has just occurred to me while writing; and although, when discussing subjects of importance, great caution ought to be exercised in promulgating new theories, still the advantages

of this mode of treatment are so obvious, to me at least, that I shall offer no apology in presenting it to the consideration of an enquiring public.

*Castle Ashby, Northamptonshire, May 24. 1839.*

---

ART. II. *Notice respecting the Effects of Kyanised Wood on growing Plants, in the Hot-houses, Pits, and Frames of the Hackney Nursery.* By the CONDUCTOR.

WE stated, in Vol. XIII. p. 365., that Messrs. Loddiges had used Kyanised wood extensively, in constructing sashes, rafters, &c., with a view to rendering them more durable. After the publication of Lord Manvers's experience on this subject, we took the first opportunity that presented itself of enquiring of these gentlemen whether they had experienced any bad effects from the process of Kyanising analogous to those which had occurred at Thoresby. The answer was, that they had, and the following is the substance of what they stated to us:—In the large palm-house some of the sashes over the ferns had been Kyanised, and the effect on the ferns was that all the old leaves shriveled up and died off. The woodwork of one of the orchidaceous houses was entirely Kyanised, and, though covered with five thick coats of paint, it had a similar effect on the old leaves of the orchideous plants as it had on the old leaves of the ferns. A pit, in which camellias were grown, was covered with Kyanised sashes, and the plants in a short time lost all their old leaves. The same thing happened to the old leaves of cucumbers in a cucumber frame. It is singular, that in the case of the ferns, the *Orchidéæ*, the camellias, and the cucumbers, the young leaves and points of the shoots were not in the slightest degree injured; but, as the leaves grew old, they suffered.

Messrs. Loddiges fully acknowledge the effect of the Kyanising process in preserving the timber from decay; and on this account, had it not proved injurious to the plants, it would have been a very great saving to them in the article of repairs. They have, therefore, left it off, but with very great reluctance, in every structure in which plants are to be grown. It may be asked whether the bad effects in the palm-house and orchidaceous house still continue to be produced, or whether time has lessened the evil. We believe the latter is the case, because every evaporating substance must sooner or later become exhausted.

The following is the essence of some communications which we have had on this subject:—

Mr. Carton, at Syon, has used Kyanised deal boxes for more than four years, for growing early cucumbers, and never discerned the slightest injury to the plants. "It is impossible," he says, "for anything to answer better." On enquiring of Mr. Parsons, the clerk of the works at Syon, respecting the Kyanising of these boxes, and the effects of Kyanising generally, as far as his experience goes, he states that cucumber boxes made of Norway deal painted, but not Kyanised, do not last above two years; but that boxes made of American white pine, which is naturally much less durable than the Norway fir, and Kyanised and painted, last five years; but then he always planes the boards, so as to take off two or three shavings after they come out of the tank, before making them into boxes and painting them. Mr. Parsons also showed us a number of planks of deal, which had been Kyanised and used for covering the sunk linings of fermenting dung, which planks, though they had been in use for five or six years, were as fresh and sound as when quite new. He has also used posts of beech inserted in the ground by the river side, where they were liable to the action of the tide, and consequently to be alternately wet and dry; and none of them have rotted, either externally or in the heart. He believes that the process of Kyanising is so effective as to

penetrate to the heart of logs of wood 1 ft. or more in thickness, whether of beech or fir; and that, at all events, Kyanised wood is not injurious either to plants or animals, as far as he has experienced. On the other hand, he is doubtful whether Kyanising will prove an effectual preservative of canvass. A large tent, the canvass of which had been Kyanised, was put up at Syon; and, after heavy rains, it was found that the matter washed from it into the earth killed the worms, which came up to the surface in the same manner as they do when the ground is watered with lime water, and died there. These worms were eaten by the birds, which also died; so that, to prevent this, the worms were collected and buried. Notwithstanding this injury to the worms and the birds, the grass sprang up with apparently greater vigour than ever. Mr. Parsons has Kyanised skins of animals, legs, hoofs, and other parts; and, after they have been hung up in the open air for several years, he has observed no symptoms of decay. In the pineries at Syon we had an opportunity of examining Kyanised cucumber boxes, and boxes which were not Kyanised, both covered with several coats of paint; and we found the latter, when struck with a piece of iron, to sound as if they were quite hollow from decay, while the former sounded as if they were quite solid. It must be borne in mind, that the circumstance of these boxes not injuring the plants may be owing to the boards being planed over as already mentioned. All the orange tubs and other plant boxes at Syon, both for the green-houses and stoves, have been Kyanised for several years past, and continue to be so.

Mr. M'Nab, jun., of the Experimental Garden, Edinburgh, has tried Kyanising for plant boxes, and finds that the wood rots more rapidly than when not Kyanised. At least this is the impression made on our minds by a short hurried conversation which we had the pleasure of having with Mr. M'Nab in London in September last; but the subject is of so much importance that we trust, when he returns home, he will favour us with his experience on the subject for publication.

Jedediah Strutt, Esq., of Belper, apprehends no bad effects whatever from Kyanising. He has tried it in various ways, and he assures us that he has grown plants in Kyanised sawdust, and perceived no difference between them and plants grown in sawdust that was not Kyanised. We wish much that this gentleman and Mr. Paxton would enable us to record their experience on Kyanising.

Sept. 20. 1839.

---

ART. III. *On inoculating the Rose on the Orange, and similar Practices; and on Mr. Long's Paper on the Quercus and Fagus of the Ancients.* In a Letter to Major Webb from his Brother, P. B. WEBB.

My dear Robert,

You tell me you will not believe Mrs. Piozzi's account (*Travels in Italy*, vol. ii. p. 224., cited in the *Gentleman's Magazine*, April, 1839, in the article, "Notes on Pinkerton's Literary Correspondence") of the inoculation of a rose on an orange, a fig tree on a lemon, &c., unless I will back her authority. You will be surprised to hear that I am bold enough to undertake this. When at Nice, in 1832-3, my old friend, Professor Risso, took me to see a monstrous "inoculation," similar to those mentioned by that learned lady, and which, I confess, without seeing and feeling like the incredulous St. Thomas, I was loth to believe. However, *I did see* a cypress, a Catalonian jasmine, an olive, and, I believe, something else, growing sociably together, engrafted on a lemon stock. How this unnatural union was accomplished I could only have learnt by purchasing the tree at an exorbitant price, and dissecting its trunk. I confess, I shrunk before a demand of 2000 francs. The author of the marvel, a common gardener, said that 99 out of a 100 of his pseudo-grafts failed. With some hesitation, as he lives

by his secret, he showed me several in their early stage; and, though he stoutly denied it, I am inclined to think that the plants to be grafted are sown in the lemon or orange trunk, and that either they cast their roots into it, or reach the ground through it.

In regard to the elegant and very erudite dissertation of Mr. Long on the *Quercus* and *Fagus* of the ancients, and the learned doubts of your brother-in-law on its conclusions, concerning which you desire my opinion, I really must declare myself too little competent to decide. The whole matter appears to me uncertain; and that even had I the time to dip deeply into it, we should arrive at little better than conjectures. After all the labours of Matthioli and his successors, of how very few of the plants named by the ancients are we specifically certain? Were they so themselves? I am myself inclined to think not. Many different objects were then confounded under the same name; and, with all our imagined science, are so still. Learned sceptics of our own age doubt even the existence of species. Other firm believers in the immutability of forms, not mere nomenclators, but philosophers, such as Reichenbach, baptise all marked variations as species: thus the dog violet, in its passage through Europe and a part of Asia and Africa, is saluted on its way, like the gods of old, by a multitude of names. What we are pleased to call vulgar names change from district to district; the same name is given to different plants at very short intervals. Witness the United States of America, where, for example, the black oak of the north is altogether another plant from the black oak of the south; and we must remember that all the ancient names were vulgar names.

I will not do Theophrastus, himself so great an observer, and the predicted disciple of such an observer as Aristotle, the injustice to suppose that it was his practice, like Pliny, to describe things he had never seen; but it is not impossible, that, in regard to the oaks, he merely recorded the accounts of others; in fact, he may only have registered what he learnt from the foresters of Ida. He unfortunately says nothing of the fruit; nevertheless, had I had his work in my head or my hand, when I climbed that mountain, I think I might have made something of his descriptions, such as they are, in ascertaining the species or varieties he had in view; but it can scarcely be done, except on the spot. The oaks I gathered in the Troad were the following:—*Quercus Ilex* Linn., *Q. coccifera* Linn., *Q. pseudo-coccifera* Desf., *Q. lusitánica* Lam. (*Q. infectoria* Oliv.), *Q. Ægilops* Linn., *Q. trojana* nob. (which is stiffer and more fastigate than *Q. Ægilops*, with a cup somewhat similar, and rigid leaves shining on both sides; and was very sparingly spread over the plain, mixed with the *velanida*, to the southward of Alexandria Troas), *Q. Ròbur* Linn., and *Q. Cérris* Linn. About Kuckoonlou-Tepe this last species assumes the form called *Q. crinita* by Olivier; and higher up the mountain, if I remember right, that with leaves more entire, and a smaller and less bristly cup, which has been called *Q. austriaca*.

The comparison of these modern names with those of Theophrastus is not very easy.

1. *Hemeris*. Though I agree very generally with the adaptation of the Theophrastian nomenclature, proposed by Mr. Long, I cannot believe that the *Cérris* could have been his *Hemeris*, principally on account of its bitter acorn; and still think, as I mentioned in the *It. Hisp.*, that we must look for this tree either in *Q. Ballota* Desf. (*Q. rotundifolia* Lam.), or, more probably, in some of the sweet-fruited oaks mentioned by Professor Tenore in his *Sylloge*, which, whether species or varieties, are as yet but imperfectly known. The *Q. gramúntia* Linn. must be erased from our catalogues. It was a mere variety of *Q. Ilex*, from the wood of Grammont, near Montpellier, in which, from my own experience, I can vouch that many more such species might be selected, depending on the mere forms of leaves.

2. *Ægilops*. I agree generally with Mr. Long that this and the *Æsculus* of the Latins, to the greater part of the ancient world could only have been the *Q. Ròbur* Linn., and its numerous varieties, as well as the fine species called

*Q. brütia* by Tenore, which, from dried specimens I possess from that distinguished botanist, may be only a splendid variety of it. Notwithstanding this, though it may appear paradoxical, I cannot avoid thinking that the *Cerris* was likewise confounded under this name in the Idæan chain; for it is by far the finest species in the district, and, as I mentioned above, the nomenclature of those times was very vague.

3. *Platyphyllos*. I agree with Mr. Long that this was probably the *Q. Ægilops* Linn.

4. *Haliphlæos*. I think, likewise, that it is very probable that this tree was the *Q. lusitânica* Lam. (*Q. infectória* Oliv.). This latter name would be better adapted to it; but, in the present state of the science, the imperious necessity of adhering to priority obliges us to accept the former. Like many other species, *Q. Tõza* Bosc, for example, it is sometimes a bush, at others a tree of more or less elevation. This happens even to *Q. Rõbur*, whose varieties, *Q. glomeràta*, *Q. viminàlis*, and others, produce their fruit on very low stocks.

5. *Phegos*. Mr. Long appears to me to have fully established that this tree was the chestnut. It appears to me, also, that he has great merit in showing that the *Fagus* of all the earlier Latin authors was the wild chestnut. But it is probable that the beech was even then confounded with it. The beech is a rare tree in Italy and Greece, where it begins to approach its southernmost geographical term, and, in so doing, follows the universal vegetable law, which causes the plants of the arctic coasts to mount the Alps, and our Canarian euphorbias of the maritime region to reappear, not on the tropical shore, but on the hills of the islands of Cape Verd. The beech, found only on the higher regions, was probably considered as a mountain *Fagus*. It might be doubted whether Virgil was acquainted with it, were it not for the passage alluded to by Mr. W. Currie, where he describes it as a light white wood, fit to make plough handles, and likens it to the *tilia*, which, compared with other passages, seems to prove that he confounded it with the chestnut. It certainly never grew along the slopes of the Mincio, “*Quà se subducere colles incipiunt;*” and the “*patula fagus*” of Tityrus must have been a chestnut, unless that shepherd had roamed high up into the subalpine region.\* Pliny certainly knew the beech; and, as far as his personal knowledge reached, it was the plant he looked upon to be the *Fagus*; but when, with his indiscriminating appetite, he assimilates to himself the observations of others, he confounds the *Fagus* with the chestnut, as in his “*dulcissima omnium fagi;*” and his assertion, that the beleaguered Chians lived on beech mast, a food to be procured no where in the Greek Archipelago, unless brought down in shiploads from the forests of Hæmus. Cæsar, when he asserts that the *Fagus* did not grow in Britain, could only, unless he was misinformed, have meant the chestnut.

Notwithstanding the assertion of Mrs. Piozzi, which I corroborate above, the beautiful passage of the *Georgics*, on grafting, appears to me to prove only that Virgil, practically, was little versed in the subject. Nevertheless, though the idea is ingenious and ingeniously sustained, yet I am of the opinion of the writer in the *Gentleman's Magazine*, that the beauty of the passage would be lost, if we agree with Mr. Long that in the words “*Castanæa fagos*” he alluded to the insertion of the chestnut on its own stock. We must, I think, with Mr. W. Currie, consider the text as vitiated, and adopt the alteration as proposed by the judicious Heyne.

*Boulogne-sur-Mer, August 17. 1839.*

---

\* The *Fagutales* of the neighbourhood of Rome could only have been chestnut groves.

ART. IV. *Remarks on Mirbel's "Nouvelles Notes sur le Cambium,"* extracted from a Work on the Root of the Date Palm. By JAMES MAIN, A.L.S., &c.

M. MIRBEL has been long known as an eminent vegetable physiologist. He was the first who, from various experiments executed with the greatest care, was able to give a rational account of the manner of the annual accretion of dicotyledonous stems. He proved the truth of the discoveries of both Grew and Duhamel, namely, that the cambium was a distinct member of a tree, and that it was that substance whence all the annual growths proceeded: in other words, that every new member existed, in the first stage of its identity, in the state of what is called cambium.

It may be necessary to state that the member of a stem which is known by this name is always visible, during the summer months, between the bark and the former year's alburnum. From the commencement of the growth in the spring, up to the months of July or August, it is of a mucilaginous whitish substance, and is, in fact, the new layer of wood increasing from its thin colourless state in winter, to its perfect bulk, hardness, and organised form of timber, which takes place sooner or later in autumn. This is a fact which is not only insisted on and clearly proved by M. Mirbel, but by every person in the least acquainted with the physical structure and annual growth of dicotyledonous stems.

Now, as that change of mucilaginous matter into perfect timber is an established fact, M. Mirbel, it seems, had a great desire to discover, by observation, how, or by what gradations, this remarkable change took place. He states that he was constantly engaged in the study of this hidden process: and at last found, accidentally, a good opportunity of observing the growth and changes of the cambium on the roots of the date tree (*Phoenix dactylifera*). He does not say where he met with such a subject; but it was, probably, one in a hot-house of the Jardin des Plantes, of which garden, we believe, he is director. He cut a root of this palm transversely, and, with a properly adjusted microscope, observed the subsequent enlargement of the cambium in its movement towards closing the wound, or in its swelling to increase the diametric bulk of the root.

Previously to this examination, M. Mirbel had considered the cambium to be only mucilaginous, or a simple cellular body, especially in the earlier stage of its visible existence: but, during this examination, his glass showed that it was much more highly organised; containing not only cells, but various vessels (utricles), as well as real or apparent lines variously disposed.

By constantly inspecting the gradual development, M. Mirbel moreover noticed that the cambium, when first protruding or extending itself, appears with a mammillary surface; "or, at least, it appeared such." These mammæ, or granules, as other writers call them, make their appearance after the cellular organisation is visible; he also noticed and describes several curious transformations of the cells into vessels, the source whence they proceed, and their final stations and appearance; together with the thickening or shrinking of the walls or partitions (cloisons) of the vessels; the ultimate density and gradual hardening of the exterior parts. The whole investigation is particularly interesting, especially to those who wish to look beyond the surface of things, and to have accurate ideas concerning the phenomena of vegetable development.

Such discoveries are only practically useful, as showing that the cambium is an organised body, even when it first appears with not greater consistence than a "solution of gum Arabic;" and that it is not a fortuitous accumulation of the descending sap.

Had M. Mirbel's very patient investigation no other result than setting us right on this point of vegetable physiology, his labours would have been highly creditable to him as a philosopher; for it is well known that hardly two, of all those who have written on the subject, agree in opinion. Grew's ideas have

been fully proved by Mirbel. Those of Linnæus, Knight, Du Petit Thouars, Poiteau, &c., are only seemingly theoretical fancies. A living author thus expresses himself: — "The cambium is not a simple and homogeneous substance; and, if in the animal system, bone always finds bone in the same blood, and muscle always muscle, so, in the vegetable system, bark may always find bark in the same cambium, and wood always wood. The organised and living molecule abstracts from the alimentary mass such particles as are suited to its own development, and always produces its own type."

The first line of this quotation accords with what has been proved by M. Mirbel; but all that follows is a transcendental assumption, which the writer would find it as difficult to explain, as his readers to understand. Besides, explaining vegetable development by reference to that of animals is neither philosophical nor satisfactory: there may be some analogy between the blood of animals and the sap of plants, but it is so very distant, that nothing certain can be elicited by a fancied comparison.

In the course of M. Mirbel's investigation, he observed what has been noticed by other vegetable anatomists, namely, that a single cell is capable of being resolved into several others, by the splitting (*dédoublent*) of the walls; that is, the outside of the wall or case of the cell is like a lining sloughed off and inflated, to form another cell in the direction of the growth. Every cell, it seems, is so constituted; and this property of division and subdivision has given rise to the common saying, when treating of these matters, that each member can produce "its own type:" yet, by division, be it remembered, but not by abstraction of congenerous particles which float in the alimentary mass, as intimated in the above quotation.

The constitution and manner of development of the cambium were the principal objects which M. Mirbel had in view; and these he has observed and described with great minuteness. The root of this palm, he says, consists of three distinct members, apparent on a transverse section; and which he denominates the peripheric, the intermediate, and the central. At a certain stage of the growth, the outer member is separated from the intermediate by a thick layer of cambium, which appears insulated; there being no perceptible union of it with the opposing sides of the members between which it is contained. It was also observed that, during the growth, it is constantly extending itself laterally, giving off parts both to the central and circumferent members; showing not only that the cambium is the source of all accretion in the roots of the date palm, but that the process is somewhat similar to that by which it divides itself into wood and bark on the stems of dicotyledonous plants; the inner and larger portion being changed into wood to increase the axis, and a less portion thrown off as liber to thicken the bark.

If we have understood our author rightly, it appears that the members and manner of growth of the roots of the date are not much unlike those exhibited in the stems of dicotyledons; except that the latter has an additional member, namely the pith. The increase or thickening of the roots of both are certainly very similar. The amplification of the stems is, however, very different; though both are centrifugal, that is, increasing outwards: for, while the monocotyledon is enlarged by a uniform process from the centre, the dicotyledon acquires diametric bulk by annual or periodical gradations; and it is the manner in which these additions are made that was the special object of M. Mirbel's investigation, and which he has so minutely described.

It is to be regretted, perhaps, that our profound author has not decidedly adverted to the origin of the cambium; that is, from what other member it proceeds. He says it is organisable matter; that it is always seen between two other members which it serves to increase; but he does not expressly say whence it proceeds.

Linnæus thought it was produced by the pith; Grew, that the liber and wood were deposited at the same time in a single mass, which afterwards divided in two, the one part adhering to the centre, and the other to the

circumference. Malpighi conceived that the wood of one year was produced by an alteration of the liber of the preceding season. Duhamel believed that it was deposited by the secretion already spoken of as existing between the bark and wood, and called cambium: he was of opinion that this cambium was formed in the bark, and became converted into both cellular tissue and woody fibre; and he demonstrated the fallacy of those theories according to which new wood is produced by the wood of the former year. Mr. Knight removed a ring of bark above and below a portion of the bark furnished with a leaf; and remarked that no increase took place in the wood above the leaf, while a sensible augmentation was observable in the wood below the leaf. Hence an inference is drawn, that the wood is not formed out of the bark as a mere deposit from it, but that it is produced from matter elaborated in the leaves and sent downwards, either through the vessels of the inner bark, along with the matter for forming the liber, by which it is subsequently parted with; or that it and the liber are transmitted distinct from one another, the one adhering to the alburnum, the other to the bark. Mr. Knight was further of opinion that two distinct sets of vessels are sent down, one belonging to the liber, the other to the alburnum; and if a branch of any young tree, the wood of which is formed quickly, be examined when first bursting into leaf, these two sets may be distinctly seen and traced. Take, for instance, a branch of lilac in the beginning of April, and strip off its bark; the new wood will be distinctly seen to have passed downwards from the base of each leaf, diverging from its perpendicular course, so as to avoid the bundle of vessels passing into the leaf beneath it: and if the junction of a new branch with that of the previous year be examined, it will be found that all the fibres of wood already seen proceeding from the base of the leaves, having arrived at this point, have not stopped there; but have passed rapidly downwards, adding to the branch an even layer of fibrous matter or young wood, and turning off at every projection which impedes them, just as the water of a steady but rapid current would be diverted from its course by obstacles in its stream. Now, if the new wood were a mere deposit of the bark, the latter, as it is applied to every part of the old wood, would deposit the wood over the whole surface of the latter, and the deviation of the fibres from obstacles in their downward course could not occur. This, therefore, in my mind, says Dr. Lindley, places the question as to the origin of the wood beyond all further doubt. Mirbel, continues the doctor, who formerly advocated the doctrine of wood being deposited by bark, has, with the candour of a man of real science, fairly admitted the opinion to be no longer tenable; and he has suggested, in its room, that wood and bark are independent formations, which is no doubt true; but, he adds, created out of cambium, in which it is impossible to concur, for this reason. All the writers hitherto mentioned or adverted to have considered the formation of wood only with reference to exogenous trees, and to such only of them as are the common forest trees or plants of Europe. Had they taken into account exotic trees, or any endogenous plants, they would have seen that none of their theories could possibly apply to the formation of wood in that tribe. In endogenous trees there is no cambium, and yet wood is formed in abundance.

Du Petit Thouars has proposed another theory. He maintains that the new zone of wood is neither formed from the cambium, nor from leaves, but from the buds; each individual bud ejects fibrous roots like a seed, and these running down within the bark collectively form the new wood. This theory has met opposition; and when it is stated that it has been opposed by such men as Mirbel and Desfontaines, that is enough to throw it overboard. And yet it has been said that the arguments used by these gentlemen are "undoubted fallacies." Mirbel use fallacies on such a subject? impossible!

The greater part of these observations are extracted from Dr. Lindley's *Introduction to Botany*, first edition; and which are presented to show the



diversity of opinion held on this point of vegetable physiology. They also furnish good grounds of comparison between the observed facts of M. Mirbel, and the purely theoretical fancies of others.

We have already stated that M. Mirbel long ago proved the truth of Dr. Grew's ideas; and also agrees with the corresponding opinion of Duhamel, respecting the cambium being the incipient layer of wood and bark. The latter author's experiments to prove that the cambium proceeded from the bark, and not from the alburnum, are, however, perfectly vague and unsatisfactory. Fixing a thin plate of silver between the liber and the alburnum in spring, to see, at the end of the growing season, on which side of the plate the new deposit of wood would be found, was ingenious; but, unless the plate were placed with the greatest care, so as to be entirely free from the cambium, no certain result would follow; because the cambium at that season is so thin and mucilaginous, that it is impossible to separate the bark from the wood without portions of the cambium adhering to both; in which case no plate, however thin, could be so inserted as to separate the cambium from the wood, nor yet from the liber, and, consequently, the metal would necessarily be found buried in wood.

Du Petit Thouars's theory was only a renewal of the old notion of Dr. Darwin, who, on seeing new fibres descending from young shoots on the top of an old half-rotten willow pollard, concluded that the new layer of wood on all healthy trees was formed in the same manner; that is, by a tissue of radicles which descend from the living spray of the top.

But all theories which presuppose a descent of fibres from shoots, buds, or leaves, are invalid for want of proof. The ducts which convey the juices to those expanding organs, are mistaken for fibres descending from them; and besides, it would appear from the description given of the circumstance, that the fibres are formed before the leaves. All difficulties, however, concerning the constituents of the new zone of wood disappear, if we only admit, with M. Mirbel, that the cambium is the incipient layer of wood and bark; and, moreover, that it is the vital membrane whence all secretion proceeds. He has proved that it exists in the roots of one monocotyledon: and no doubt it exists in the stems also; for, when the stem of a *Cocos nucifera* is split in two, we can trace the fibrous structure of the expanded fronds for a considerable way down the trunk; other fronds are rising in their embrace; these involve others, and others a still younger set, until we arrive at a point in which all visible forms melt, as it were, into a homogeneous substance; and what is this substance but cambium?

Besides, it is now proved beyond a doubt, that cambium, as well as perfect layers of wood, is formed for many years upon the roots of certain trees, after the trunk, branches, and foliage have been dissevered; showing decidedly that the vital membrane can enlarge itself without assistance from either shoots, buds, or leaves. This is a circumstance which has been witnessed and attested by the celebrated M. Dutrochet, an authority who banishes every kind of doubt. And if so, what then becomes of all our luminous essays and lectures on "the elaboration" and "organisability" of the sap; the descent of fibres from the leaves and buds, &c.?

Although M. Mirbel has already said every thing which a practical physiologist can advance, to convince every candid mind that the cambium is the incipient layer of wood; yet it is to be wished that he had adverted to the origin of it more particularly than he has done in the present extracts.

*Chelsea, Sept. 1839,*

---

ART. V. *On the Olive and Date Plantations in New South Wales.*  
By DR. LHOTSKY.

THE hint which I had thrown out in one of the preceding Numbers of the *Gardener's Magazine* has been either soon followed, or, perhaps, anticipated,

as I have been informed, that a fine collection of 500 olive cuttings has been shipped for Sydney by one of the vessels which lately sailed for that port. Whilst this bids fair for the increase of British horticulture and productiveness, the culture of dates has been already tried in the lovely climate of Sydney. About 300 young plants of that interesting and useful palm (*Phœnix dactylifera*, the Date Palm) are now growing in the large orange gardens of Concord. They require, however, a long time before yielding fruit; because there is a tree in these gardens, now 15 years old, which has never yet flowered. It is, finally, an interesting fact for botanical geography, that whilst dates and olives are disappearing, or at least thinning, in the countries of the East, where they were first mentioned by history, we behold the fields at the antipodes now covering with these most ancient (vegetable) companions of mankind.

London, Aug. 1839.

---

ART. VI. *Botanical, Floricultural, and Arboricultural Notices of the Kinds of Plants newly introduced into British Gardens and Plantations, or which have been originated in them; together with additional Information respecting Plants (whether old or new) already in Cultivation: the whole intended to serve as a perpetual Supplement to the "Encyclopædia of Plants," the "Hortus Britannicus," the "Hortus Lignosus," and the "Arboretum et Fruticetum Britannicum."*

*Curtis's Botanical Magazine*; in monthly numbers, each containing seven plates; 3s. 6d. coloured, 3s. plain. Edited by Sir William Jackson Hooker, LL.D., &c.

*Edwards's Botanical Register*; in monthly numbers, new series, each containing six plates; 3s. 6d. coloured, 3s. plain. Edited by Dr. Lindley, Professor of Botany in the London University.

*Paxton's Magazine of Botany, and Register of Flowering Plants*; in monthly numbers; large 8vo; 2s. 6d. each.

*The Floral Cabinet*; in monthly numbers, 4to; 2s. 6d. each. Conducted by G. B. Knowles, Esq., M.R.C.S., F.L.S., &c., and Frederick Westcott, Esq., Honorary Secretaries of the Birmingham Botanical and Horticultural Society.

*The Botanist*; in monthly numbers, each containing four plates, with two pages of letterpress; 8vo; large paper, 2s. 6d.; small paper, 1s. 6d. Conducted by B. Maund, Esq., F.L.S., assisted by the Rev. J. S. Henslow, M.A., F.L.S., &c., Professor of Botany in the University of Cambridge.

*Maund's Botanic Garden, or Magazine of Hardy Flower Plants cultivated in Great Britain*; in monthly numbers, each containing four coloured figures in one page; large paper, 1s. 6d.; small, 1s. Edited by B. Maund, Esq., F.L.S.

**MALVA'CEÆ.**

*Málva lúcida* Lindl. A Nepal annual, somewhat resembling *M. sylvéstris*. (*B. M. R.*, No. 130., Oct.)

*Leguminosæ.*

1985. LUPINUS.

*Bárkeri* Lindl. *Mr. Barker's* [Q] cu 3 jn B.P.V Mexico 1838. S co Bot. reg. 1839, 56.

A half-hardy annual, or rather biennial, obtained from Mexico by Mr. Barker, and named after him by Dr. Lindley. It approaches very near *L.*

leptocarpus, but differs from that plant by "the somewhat remarkable character of the flower buds being separated from each other by a considerable distance, even when quite young." (*Bot. Reg.*, Oct.)

*Rosaceæ.*

1498. *AMYGDALUS* 12841 incana *Bot. Reg.*, 1839, 58.; *A. nana* var. *incana* *Arb. Brit.* ii. p. 674.

1528. *POTENTILLA*

hæmâtocorus *Lehm.* blood-coloured £ □ or 2 jn.au S Mexico 1838. D 1p Fl. cab. 119.

"This very distinct herbaceous species is a native of Mexico, where it was found by Schiede and Ehrenberg." The colour is a dull scarlet, and the plants appear very robust-growing. There are specimens in the Birmingham Botanic Garden, which have received frame protection during winter, and have been turned into the open border in May. (*Fl. Cab.*, Oct.)

*Cactaceæ.*

1572a. *LEPISMIUM Pfeiff.* *LEPISIUM.* (*Lepis*, a scale; ? little scales at crenatures.)

+12563 *Myosûrus Pfeiff.*, *Bot. Mag.* 3755.

*Synonymes*: *Cereus tenuispinus* *Haw.* in *Hort. Brit.* p. 195.; *C. Myosûrus Salm-Dyck*; *Cactus tenuis Schæff.*

"In the *Botanical Magazine* for the present month (October, 1839) a figure is given of the above-mentioned species, where it is remarked, that it rarely produces flowers in this country, a circumstance of which I was not previously aware. The specimen in the Oxford garden (which is about 4 ft. high, and well branched and grown in a small pot, 48 size) generally produces its flowers yearly, and this past summer more profusely than usual." (*W. H. B.*)

*Compositæ.*

[ + *BURRIELIA* Dec. (In honour of *J. M. Burriel*, author of *Travels in California*, in 1758.)

gracilis *Dec.* slender ○ or ½ su Y California 1834. S co *Bot. mag.* 3758.

A pretty annual, sent from California, by Douglas, with the lasthenias; but differing from that genus in the structure of its involucre.

2363. *DAHLIA*

scapigera *Link & Otto.* scape-bearing £ or 2 jn W Mexico 1837. Fl. cab. no. 118. ]

A very beautiful new species of dahlia, with numerous slender dwarf stems, received at the Birmingham Botanic Garden from Berlin. (*Flor. Cab.*, Oct.)  
*Aplotaxis albescens* *Dec.* A handsome herbaceous bush, 3 ft. high, a native of India, introduced by Dr. Falconer. The leaves are downy on the under side; the flower heads are paniced, "and are narrow, with pale bright purple blossoms." (*B. M. R.*, No. 129., Oct.)

*Campanulaceæ.*

+ *Codonopsis lûrida* *Lindl.* "A fœtid twining milky annual, with large green flowers, slightly dotted with purple in the inside." A native of India, closely allied to *Canarina*. (*B. M. R.*, No. 126., Oct.)

*Cyrtandræcæ.*

3175. *ÆSCHYNAËNTHUS*

ramosissimus *Paxt.* most branching £ □ or 3 jn S Khosea 1836. D [of bot. vi. p. 195. trees *Paxt. mag.*

Another species of a very remarkable genus, with narrower leaves and smaller flowers than *Æ. grandiflorus*, and readily distinguished from that plant by the peculiarly branching nature of its stems. "Within a few inches of the soil the plant will begin to send forth a number of lateral shoots; and, as these usually take an ascending direction, the plant becomes particularly dense about this part of its stem. . . It may be cultivated and propagated precisely as *Æ. grandiflorus*;" that is, potted in moss, "with the stems attached to a block of wood, around which, if assisted by a little sphagnum, will speedily form roots, and by this means may be increased." (*Paxt. Mag. of Bot.*, Oct.)

*Gentianæ.*

794. *GENTIANA* 6372 verna var. alba *Bot. Gard.* No. 712.

This pretty white variety of the well-known *Gentiana verna* is grown by Messrs. Pope of the Handsworth Nursery, near Birmingham. (*Bot. Gard.*, Oct.)

*Bignoniæcæ.*

1706. *BIGNONIA* 28670 jasminoides.

*Synonyme*: *Tecoma jasminoides* *G. Don*, *Paxt. mag.* of bot. vi. p. 199.

This beautiful climbing green-house shrub, the flowers of which are pinkish, rather than purple, has been splendidly flowered by Mr. Webster, gardener to Mrs. Huskisson, at Eartham, by confining its roots to a small pot. "In this simple fact lies the whole art of flowering plants perfectly; and nothing can be more prejudicial to a species like the present, which is constitutionally disposed to grow luxuriantly, than planting it in a bed or border, where its supplies of fluid cannot be completely controlled, and its roots judiciously limited." (*Past. Mag. of Bot.*, Oct.)

*Boraginæ.*

*Cynoglossum glochidiatum* Wall. "A straggling herbaceous plant, about 3 ft. high, of a loose inelegant habit of growth." The flowers are small, but of an intensely bright blue, and the leaves, though few, are of a very bright green. "It is quite hardy, and was raised by the Horticultural Society from seeds sent from India by Dr. Falconer." (*B. M. R.*, No. 128., Oct.)

*Scrophularinæ.*

1807. *ANGELO'NIA*  
Gårdneri Hook. Mr. Gardner's  $\square$  or 3 my L Pernambuco 1838. D s.l Bot. mag. 3754.

This very beautiful plant was found by Mr. Gardner in open dry places in the province of Pernambuco in Brazil. "Seeds were sent to the Glasgow Botanic Garden in 1838, and plants raised from them flowered in the stove there in May, 1839." The flowers are large and handsome, and produced in great abundance. (*Bot. Mag.*, Oct.)

*Labiatae.*

*Sálvia Moorcroftiana* Wall. A herbaceous species resembling *S. Sclarea*, with very large leaves and light blue flowers; raised from seeds sent from India by Dr. Falconer. (*B. M. R.*, No. 127., Oct.)

*Verbenæceæ.*

1749. *VERBENA*.  
29324a officinâli-venõsa *W. H. B. hybrid*  $\text{£} \Delta$  or 4 jl.o Bsh Oxford Gard. 1837. D co

"When in a young state this plant very nearly resembles *V. venõsa*; but as it advances it assumes a much more robust habit (growing to the height of 4 ft.), becomes much branched, and produces its bluish flowers, which are about the size of those of *V. officinâlis*, in somewhat longer and looser spikes than those of *V. venõsa*; the bractæ are also shorter than in the latter species. We imagine that it must have been produced by accidental impregnation between the two above-mentioned species, from the circumstance of there having been plants of both species growing, and still remaining on the spot where the hybrids first appeared. The plants certainly partake of the characters of both *V. officinâlis* and *V. venõsa*, favouring the latter, however, in nearly all respects except its robust habit, much-branched stem, and smallness of its flowers." (*W. H. B.*)

*Amaryllidæceæ.*

948. *AGA'VE* 31523 *Saponâria* *Bot. Reg.* 1839, 55.

This very curious plant, which is used as a substitute for soap in Peru, very closely resembles the *Poliánthes mexicana* of Zuccarini. "Its culture is very simple. When it is in a growing state it should be placed in a temperature a little higher than that of a common green-house. It never requires much water, and in the winter months it should be kept nearly dry. The soil used in potting should be fresh loam mixed with a considerable quantity of sand." (*Bot. Reg.*, Oct.)

979. *ALSTRÆME'RIA* 8047a *acutifolia-aúrea* *Botanist*, No. 137.

This beautiful hybrid was raised by Messrs. Pope of the Handsworth Nursery, near Birmingham, and they are of opinion that it would flower freely if planted out against a south wall. The greater part of these plants, Mr. Herbert observes, "are natives of elevated situations, and dislike a high temperament, and will endure the winter if planted pretty deep in a light soil, and covered over with leaves in the cold season." (*Botanist*, Oct.)

## Orchidaceæ.

3582. LÆLIA 31629 albida Bot. Reg. 1839, 54.

2510. ONCIDIUM  
trulliferum Lindl. trowel-lipped  $\text{♀} \square$  or 2 s Y.s Brazil 1837. D p.r.w Bot. reg. 1839, 57.

A very distinct species of this well-known genus. The shape of the middle lobe of the lip resembles that of a bricklayer's trowel, whence the name. "In cultivation it requires the damp stove." (Bot. Reg., Oct.)

2558. PHAÏUS  
+ Wallichii Paxt. Dr. Wallich's  $\text{♀} \square$  or 2 jl Y.s Khoseea 1837. D p.l [bot. vi. p. 193. Paxt. mag. of

This very beautiful plant was introduced by Mr. Gibson, who found it on the Khoseea hills, growing on the rock under a dense covering of trees. "Those who cultivate the peristerias successfully will find the treatment bestowed on them perfectly applicable to this plant." It should be abundantly stimulated in summer, but kept as dry as possible in winter. (Paxt. Mag. of Bot., Oct.)

3412. STANHOPEA  
maculosa Kn. & West. spotted  $\text{♀} \square$  or 1 au B.o Mexico ? 1839. D p.r.w Fl. cab. no. 121.

This species resembles in several respects *S. tigrina*; but differs in the much smaller size of the flowers and their general marking. (Fl. Cab., Oct.)  
*Asphodelaceæ.*

9540. DAUBENYA  
fulva Lindl. tawny  $\text{♂}$  cu  $\frac{1}{2}$  au S ? Madagascar ? 1836. O co Bot. reg. 1839, 53.

This very curious plant was observed by Professor Royle in flower in a garden at Wandsworth, by the proprietor of which it had been received with other bulbs from the Cape of Good Hope; but it was believed to have been discovered on the east coast of Africa, or in Madagascar. (Bot. Reg., Oct.)

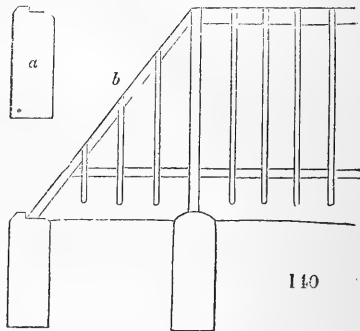
ART. VII. *Design for a Trellis for Fruit Trees erected in the Gardens of Sir James Carnegie, Bart., Kinnaird Castle, Forfarshire.*  
By ROBERT GARDINER, Gardener there.

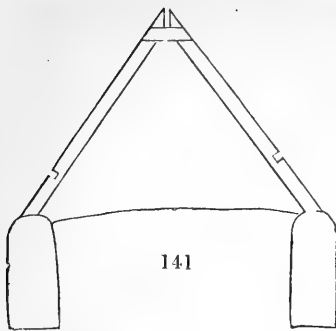
THIS trellis is double, the cross section being in the form of the letter A: the rafters rest on blocks of stone sunk in the ground to within a few inches of their upper surface.

Fig. 140. represents part of one of the sides of the trellis. The ends may either be made to slope at the same angle as the sides, as in fig. 140. *b*; or they may be perpendicular, as in fig. 141. The rafters of the trellis rest on blocks of stone, 9 in. on the side, and 20 in. long, as at *a* in fig. 140.

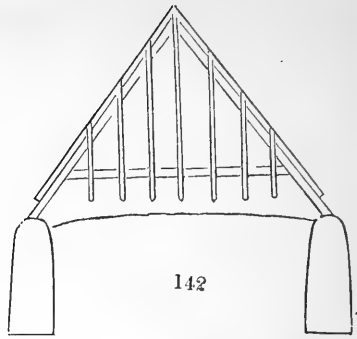
Fig. 142. shows the rafters, in the apex of which is placed the ridgeboard for the ends of the rails to abut against.

The whole is painted of a dark brown colour. The width at the surface of the ground is 6 ft. and the height is about 7 ft. In this garden it is 100 yards in length, and stands





141



142

in the direction of east and west ; and portable linings of wooden boards are slipt in under the rails of the trellis on the south side, when the fruit is swelling off.

This trellis has, I think, some advantage over the common espalier rail :— 1. it can be put up at much less cost ; 2. it requires no ironwork ; and, 3., no part of the woodwork touching the ground, if kept tarred or painted, it will last for many years. Another advantage is, that those roots of the trees which are under the trellis are never disturbed by the spade. Our trees are apples and pears grafted on quince and paradise stocks ; they were planted two years ago, about 8 ft. apart, and they are now coming into excellent bearing.

*Kinnaird Castle, Brechin, Jan. 18. 1839.*

---

ART. VIII. *On the Peach.* By ALEXANDER FORSYTH.

THE peach border may be made of pure maiden loam, or the turf thinly pared from any good pasture, piled in narrow stacks at least one year previous to its forming the peach border, without any additional compost or manure whatever, laid  $1\frac{1}{2}$  or 2 feet deep on a well-drained substratum.

The trees planted 3 in. deep, and mulched with 4 in. deep of half-rotten dung, to retain the moisture about the roots, is all that I consider necessary in planting the peach.

In training this tree, nothing like a system was ever seen practised, until Mr. Seymour's plan appeared. However, to save a tale of some length, respecting the merits and demerits of different modes of training, I shall detail one which I hope will set the matter at rest, founded upon reason, and a knowledge of the nature and habits of the tree ; a basis from which, I confidently trust, it will not, with rational persons, be easily or speedily removed.

A maiden tree (that is, a tree the first year after budding)

sends out lateral shoots on all sides; these are laid in, at three bricks' depth apart, horizontally, and are encouraged as much as possible by stopping the upright leader, and again stopping the laterals it may send out, in order to throw sap into the horizontal branches, which are allowed to run 9 ft. on each side of the trunk, supposing the wall 12 ft. high. Two shoots on each side may be got the first year, and three or more after, according to the luxuriance of the tree; always establishing every horizontal shoot well before the upright leader is allowed to make head; and no fruit must be allowed to remain on the lower two or three tiers of wood the first two years, unless they are over-luxuriant. As the tree advances it must be carefully disbudded, in order to leave young wood in proper places.

But the principal feature in the culture of the peach tree is, to stop the leaders of the bearing wood, at four or five eyes beyond the parent bud, thereby throwing the sap into the fruit, and also into the latent eyes at the base of the one-year-old wood, which must break if you allow no other buds to remain without being stopped as soon as they protrude; and, as is well known by every one the least acquainted with the habits of this tree, it invariably produces wood buds at the beginning and ending of every one-year's shoot. All laterals from the green wood, at the extremities of the present fruiting-branches, must be carefully stopped at one or two leaves from the parent.

In winter pruning, the young wood may be left entire, or cut at a wood bud to any desirable length, according to the luxuriance of the tree.

This system, being notoriously simple and regular, will be understood at a glance by every one. The trees can be pruned and trained in one third less time than when trained fan-shape; as there is little consideration wanted as to what must be left or cut out; and only one place, that is, by the seams of the bricks, where every shoot must be nailed. Every tree will be definite in size, and handsome in figure, forming a parallelogram, whose length is to its breadth as three to two; and every foot of the wall will be alike advantageously employed. They will also stand in harmonious relationship to each other; and to the ends and corners of walls, &c.; not as now, threatening to cross each other, and actually crossing every thing else with which they are connected. But the greatest advantage remains to be told, and that is, that the present necessary and ruinous practice of amputating large limbs annually, in order to get bearing wood near the bole of the tree, will be entirely done away with; as the only winter pruning now will be, to cut out the wood that bore the fruit, as is practised with raspberries.

Venerable cultivators of the peach in olden time, what say ye to this? The tree on which it would have been sacrilege for a young gardener to have lifted his knife, is now simplified to the same principle that guides the pruning of the humble and unpretending raspberry vine.

In forcing the peach, the greatest care is necessary to preserve a gentle atmosphere, excess of dry heat is ruinous at any period; and every leaf of a peach tree under glass ought to be moistened with a very fine syringe at least twice a day, the first thing in the morning, and before sunset in the evening. When the fruit begins to ripen, this may be lessened; and, when all is gathered and the house thrown open, the leaves ought to be syringed in dry weather, every night, till the fall of the leaf, to keep down insects, and invigorate the leaves to form fine plump flower buds. When the trees are in bloom, of course there will be no syringing over the blossoms, but the walls and pathways, as well as the pipes or flues, must be regularly moistened, in order to supply vapour.

In forcing this, as in many other stone fruits, a free circulation of air, and a temperature nicely adjusted, of from  $55^{\circ}$  to  $65^{\circ}$ : the former gradually got up is, in my opinion, the best for flowering and stoning; and the latter, gradually raised (say by  $2^{\circ}$  a week), for swelling the fruits.

The sorts I should cultivate for forcing are, Elruge and Fairchild nectarines. The Noblesse, Violet hâtive, Early purple, Montauban, and Old royal George peaches. The nectarines I should plant in the hottest part of the house. These, with perhaps the Late admirable peach, and the small late New white nectarine, may answer every purpose, for an ordinary supply, out of doors. And here, as connected with the peach, I may mention a ready way of picking and cleaning old wall-nails, communicated to me by a friend. He never uses old shreds, for fear of insects; and, as soon as the trees are unnailed, he bundles nails and shreds into a fire of wood, and sifts the ashes from the nails, which he afterwards scrubs and washes with a broom in a trough of water.

*Aldersley, Cheshire, 1838.*

---

ART. IX. *On preserving Plums.* By M. W. C. BOSSE,  
Nurseryman, Quedlinburg.

(Translated from the "Garten Zeitung" of Feb. 3. 1838, by J. L.)

I HAVE for several years tried to preserve different kinds of fruit for a greater length of time than they are generally kept, and by this means have obtained several very interesting results.



Of all the kinds of fruits, none is a greater favourite with me than the common plum, and it is therefore not remarkable that my particular attention should have been directed to it. I thought there could be nothing more delightful than to be able to produce plums for the dessert at Christmas or Easter; and, as I have succeeded in accomplishing both, I thought I could not do better than communicate the particulars to your readers, especially as I have frequently heard complaints of unsuccessful attempts in such pursuits.

I gathered the plums in the autumn with a pair of gloves on, taking care to cut them off very carefully with a sharp pair of scissors, so as to retain the whole stalk; and to see if the fruit were ripe, but not withered at the stalk. After I had collected a considerable number in this manner, I rolled up each plum separately in soft paper, and laid them carefully in a well burned and glazed jar, which I now covered closely with a double bladder. I also wrapped up an equal number of plums in paper, and put them in a wide-mouthed bottle, which I closed up in like manner. I then filled some bottles with dried pear leaves (because they have always appeared to me to be particularly disposed to resist decay), and laid the plums so among them, that one might not touch the other. I then filled a bottle with plums without putting anything between them, and shut them up as I had done the others.

I now had a hole dug in a dry part of the garden, 3 ft. deep, put in all the vessels containing the fruit, with a piece of brick on the top of each vessel, and filled up the hole. When frost set in, I put on a layer of leaves, so as to enable me to dig out any of the vessels when necessary.

I opened the hole the following year, and found my plums in the following state:—

Those in the jar were in tolerable condition, but they should have been looked at sooner, as those at the bottom had lost their flavour, and the paper, particularly at the sides of the jar, had become quite damp.

Those wrapped up in paper and in a bottle, were in much better condition; only a few were decayed at the bottom, and the paper was quite dry.

Those plums, however, among the dry leaves were the best of all. They had not lost the least of their bloom, and the flavour was as if they had just been taken from the tree. My joy was great at this favourable result, and I can therefore recommend this manner of preserving plums with the greatest confidence.

In preserving the plums with pear leaves, I always put in a layer of leaves at the bottom of the bottle, then plums, keeping them separate from each other by the leaves and also from touching the sides of the bottle; but on opening the bottle I found

that by accident some of the fruit had touched the glass, yet they were in as good condition as the others. The leaves were those of the *Beurré blanc*, *Bergamotte d'automne*, and *Mouille bouche*, because they were the driest at the time.

Those plums which I put in a bottle, without any covering of paper or leaves, were for the greater part decayed, and those that were not so were unsightly, and the stalks gave way on the slightest touch. Those, however, that were preserved in the pear leaves afforded me the pleasure of distributing them as presents at Easter, and therefore my wishes were completely gratified.

I made the same experiments this last autumn, but on a larger scale, and the result proved the same. I intend to make more experiments on preserving plums, particularly by putting them in closely stopped bottles and immersing them in water. There is no doubt that this attempt will be successful, because an equal temperature and exclusion of air seem to be the principal agents in preserving fruit, and where can both be obtained with greater certainty than in water?

Having now made my method of preserving plums known to your readers, allow me to request them to communicate their experience on the subject, in like manner, through the medium of your journal. It will not only be very interesting, but be very useful in large towns and in the country generally.

---

ART. X. *On the Culture of the Carrot.* By ALEXANDER FORSYTH.

In preparing ground for carrots, I should trench in autumn; and afterwards lay on a layer of old hot-bed dung, or other half-rotten dung; and allow it to remain on the surface, exposed to the action of the elements, until March; when it may be *pointed in*, and the seed for the principal crop sown in drills half an inch deep, and about a foot apart. The plants to be thinned out, first, when about an inch high, to one inch apart in the row; and afterwards, when they are about the size of salmon radishes, to two inches apart. The quantity of seed requisite for any given space may be computed at one and a half ounce to the pole. For young carrots fit to draw early in the spring, a sowing may be made about the 12th of August, in a well drained, airy, sheltered situation, to stand the winter without protection, in rows, six inches apart, half an inch deep, and thinned out to about three in an inch in the row. In January, a sowing may be made on a slight hot-bed, say 3 or 4 feet thick of leaves, with an upper stratum of any friable soil, about 6 in. deep, the surface of which, when finished, may run parallel with the glass, at a distance of about 4 in. from it (say a three-light box, or

70 square feet, for an ordinary suburban family). Sow in drills, half an inch deep, and 3 in. apart, and thin the plants to about three in an inch in the row. From the time that the plants appear above ground, let them be exposed, by taking off the lights all day, and every day, except in cases of storm and frost; thus treated, they will come into use in beautiful succession, connecting the autumn and spring-sown supplies from the open ground. In February, a small sowing may be made on a warm border, to succeed the forced ones. This sowing had better be protected by an awning of mats (see awning for strawberries, Vol. XIII. p. 308. fig. 107.), till the weather gets settled. Sorts: The Early horn may be grown in all cases, except for the principal winter stock; three fifths of which may be Altringham, one fifth New green-topped white, and one fifth Early horn. Storing: — About October, the crop may be dug up, with about an inch of top to each, and stowed away in dry soil, in narrow tiers, with their root ends inward, overlapping each other, and forming a wall of shorn carrots about 18 in. thick. An open shed (not open to thieves, but with open latticework), fronting the north, will be found an excellent store-room for these roots.

*Isleworth, 1838.*

---

ART. XI. *On the Queen Bee that leaves the Hive with the first Swarm.*

By J. WIGHTON.

HAVING some doubts as to whether it is the old queen who goes off with the first swarm from a hive, I made the following experiments. I examined a hive on the 12th of March, which contained bees in every stage, but no drones were hatched. I cut off the wings of the queen; who, while in my hand, dropped two eggs. On the 12th of June this hive swarmed; the bees collected on the higher branches of a tree, but soon returned to the hive, and upon searching I found the old queen on the ground, in the wingless state in which I had left her three months before. I replaced her in the hive. Three days of bad weather succeeded, but on the fourth the swarm again came off, the poor queen falling to the ground, as on the previous occasion; finding the disappointed bees beginning to return, I carried the queen to them, when they immediately settled about her, allowed themselves to be quietly hived, and have since done extremely well under their wingless mother.

In an article on the calling of queen bees before swarming (in p. 25.), I stated my inability to account for their silence before the first swarm, except upon the supposition that the old queen went off with it eight or ten minutes before her successors left their cells. This having been ascertained to be the case,

the silence is so easily accounted for, that it appears strange the inference should have been overlooked by the most able apiarians, especially Huber, who was well acquainted with the train of facts that led to it. It is clear that the old queen is impelled by instinct to quit the hive with the first swarm, a few days before the young queens are hatched; and consequently before any rival appears in the field to dispute her sovereignty. This is not the case with her successors; the first who is hatched, and from whom the stronger sound of "peep, peep," proceeds, makes her appearance before her rivals, who are still in their cells, nevertheless sufficiently forced to utter the weaker call of "off, off," so interpreted in Norfolk amongst old bee-keepers, as conveying the true meaning of the cry; though, perhaps, some would be inclined to apply the old rhyme to it:—

"As the fool thinks  
So the bell clinks."

The newly hatched queen, however, upon hearing it, attacks the cells containing her rivals, as confirmed by the able authority of Dr. Dunbar (p. 149.).

Many apiarians dispute this view of the case. There are instances of calling being heard before the first swarm. Keys, I think, says that if such piping is heard, the apiarian may console himself as he best can, for he has lost his first swarm. Such a very rare occurrence (for rare it undoubtedly is) may, however, be accounted for in two ways: either some accident has happened to the old queen, or stormy weather has delayed the coming off of the first swarm, till the young queens have commenced their piping.

I am obliged to your two correspondents for their notices on my article, especially to Dr. Dunbar for his able account of the calling of queens. He has quite satisfied my doubts on that head; nevertheless, I must be allowed to point out some incongruities in his manner of stating certain points in his subject, as well as some very doubtful quotations from Huber. He states that the queen, in the after-swarms, *hearing* her rivals in their cells, attacks them; some of the bees prevent her efforts, and she in a rage goes off, taking a part of the bees with her. By this it appears that she leaves the hive before any of her rivals have come forth, which certainly is not the case, as there are frequently several queens in an after-swarm. The truth is, such a swarm does not come off till some queens have left their cells, when there is a general uproar in the hive, and the lady paramount, assisted by her subjects, destroys both those who do not quit the hive, and those who mingle with the swarm on its exit. It is probable that some queens are still left unhatched; for if the time be ever so short between the second, third, and

fourth swarms, the same calling is invariably heard before each, and I know no instance of swarming after the destruction of queens too young to quit their cells. The assertion, also, that the old queen is not fiercely disposed towards the young ones, is in some degree set aside by the after-statement, that, if delayed by stormy weather till they are hatched, she destroys them.

The idea that the queen goes abroad in search of drones is hardly sufficiently established to warrant the conclusion derived from it by some, viz. that it is the immediate cause of swarming. Swarming takes place usually when the hive contains its largest supply of drones, so that the queen quitting it at such a moment, and for such a purpose, would appear to be without reason. Her leaving it *quietly*, as stated by Dr. Dunbar, could scarcely mean that she quitted it alone (at swarming time). This would be against all experience; and her welcome reception, if she succeeded in her mission, would imply that she would be ill received if she did not; a circumstance equally at variance with all observations hitherto made. The destruction of the rival queen, is, I think, more reasonably accounted for in the previous part of this article; at the same time, I would not wish to place my scanty apiarian knowledge against the more learned experience of Dr. Dunbar. I am only anxious to establish a clearer understanding upon this point than his article gives ground for.

*Cossey Hall Gardens, Sept. 9. 1839.*

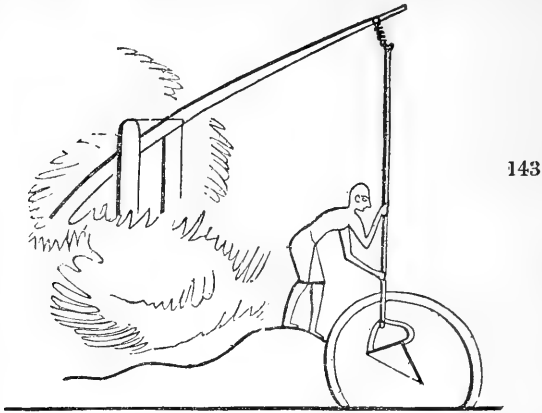
## REVIEWS.

**ART. I.** *Manners and Customs of the Ancient Egyptians, including their private Life, Government, Laws, Arts, Manufactures, Religion, and early History, derived from a Comparison of the Paintings, Sculptures, and Monuments still existing, with the Accounts of Ancient Authors. Illustrated by Drawings of these Subjects.* By J. G. Wilkinson, F.R.S., M.R.S.L., &c., Author of "A general View of Egypt, and Topography of Thebes," &c. 3 vols. 8vo, numerous cuts and plates, plain and coloured. London, 1837.

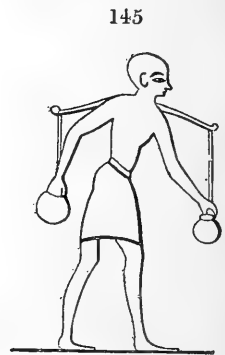
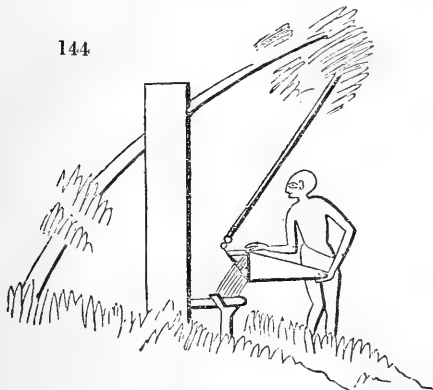
### GARDENING AND AGRICULTURE OF THE ANCIENT EGYPTIANS.

THESE are remarkable volumes, which every gardener who has read his bible would feel a deep interest in perusing. We have looked over them chiefly with a view to glean what we could respecting the state of agriculture and gardening in the remotest period of history. As the general result, we may state that the practices which were in use from 1500 to 2000 years before the Christian era, are as near as possible the same as those which exist at the present day in the same country, and, indeed, in similar climates and situations throughout the world. The great leading features in corn culture, and in the culture of culinary vegetables, are the choice of a flat alluvial surface near water, and the irrigation of this surface, by conducting the water along open channels among growing plants. The water was commonly raised from a river, canal, tank, or well; and it is remarkable, that the contrivance in most general use for this purpose, in the most remote ages, is

that which is not only now generally in use in Egypt, but throughout the whole of the East, in Persia, in India, in China, Japan, and, in short, wherever the culture of culinary vegetables is practised, from Peking to the neighbourhood of London. In the shadoof of the Egyptians, which is represented in *fig. 143.*, taken from Mr. Wilkinson's work, vol. ii. p. 4., the



reader will readily recognise the long lever and bucket so commonly in use in the market-gardens about London, and which he may see in abundance when walking from Hammersmith to Brentford. Lest the reader should be puzzled by the appearance of the circle round the bucket in *fig. 143.*, we may apprise him that the circle is intended to represent the rim of the well, the Egyptians having no idea of true perspective, but representing objects on a plane as rising one above another. In *fig. 144.* of the same page of the same work, a cultivator is represented pouring the water from a bucket into a spout,



doubtless to conduct it to a tank for more convenient use, or, perhaps, directly to the open gutters among the plants, as is done in the neighbourhood of Naples. In *fig. 145.*, taken from the same work, vol. iv. p. 137., pails of water are carried by the cultivator, suspended from a wooden yoke borne upon the shoulders. Other figures given by Mr. Wilkinson represent the gardener pouring out the water from these buckets on the plants; and in one cut, vol. iv. p. 5., the gardener is seen with his water-buckets in a

garden, containing palm trees, other trees which cannot be recognised as of any particular species, and a nelumbium or lotus.

*Agriculture.*—The ground was generally cultivated on the metayer system; the cattle, flocks, or herds, belonging to the landlord, and the animals used in ploughing, the implements, seed corn, and labour found by the farmer. The latter was bound not to injure the soil by a repetition of similar crops. They were left, however, to choose the kind of crops which they should cultivate; and, according to Diodorus, as quoted by Mr. Wilkinson, "They carefully considered the nature of the soil, the proper succession of crops, and the mode of tilling and irrigating the fields; and by a constant habit of observation, and by the lessons received from their parents, they were acquainted with the exact season for sowing and reaping, and with all the peculiarities of each species of produce." (*Manners and Customs of the Ancient Egyptians, &c.*, vol. ii. p. 3.) The Egyptians had a particular hatred to shepherds, owing to the previous occupation of their country by a pastoral race, who had committed great cruelties during the time they had possession of it. Hence the great prejudice against Jacob and his family when they arrived in Egypt. In the pictures of shepherds on the tombs, they are caricatured and represented as a deformed and unseemly race. The swineherds, who were the most ignoble, were not permitted to enter a temple. It is remarkable that the swineherds in India are equally despised, though it does not appear for what reason.

The skill of the Egyptians in rearing animals is said by Diodorus to have been greater than that of any contemporary people, in proof of which, he says that sheep were twice shorn, and brought forth lambs twice in the course of one year; and their mode of rearing fowls without the incubation of the hens he remarks as a practice worthy of all admiration. (p. 17.)

*Culture.*—The palm is never found in Egypt, except in places where it has access to water, notwithstanding the expression in scripture, "palm trees of the desert." There are no palm trees in the desert, Mr. Wilkinson observes, except at the oases, those spots where springs lie near the surface. The "cultivated palm is reared from offsets, those grown from the stone producing an inferior fruit; and the offsets, which are taken at about seven years' growth, bear dates in other five or six years, the tree living sixty or seventy, or even upwards, according to circumstances connected with the soil, or the mode of its culture. The Theban or dôm palm (*Cucifera thebaica*) was much cultivated for its timber as well as for its fruit, and it is still in repute for both. It differs from the date palm, in having always bifurcated limbs. About 5 ft., less or more, from the ground, the stem divides into two branches, each of which again separates into two others, and these again into two other pairs, always by twos, the uppermost sets being crowned by the leaves and fruit." (p. 179.)

The lotus, the papyrus, and other similar vegetables, were, during and after the inundation of the Nile, the greatest blessing for the poor, and, like the acorn in northern climates, constituted, perhaps, their sole aliment at the door of civilisation. Next came leguminous plants, corn, and the palm, more particularly the date. The onion was much in demand, though it seems not to have been allowed to be eaten by the priests. Gourds, cucumbers, melons, leeks, and garlic, were also much esteemed, and eaten raw, as well as cooked, by persons of the high as well as lower classes. "Niceretas observes that onions relish well with wines, and cites Homer in support of his remark. Callias affirms that they inspire courage in the hour of battle; and Charmides suggests their utility "in deceiving a jealous wife, who, finding her husband return with his breath smelling of onions, would be induced to believe he had not saluted any one while from home." (p. 374.)

*Gardening.*—The gardeners of Egypt were employed by the rich "in cultivating trees and flowers in the parterres attached to their houses; and the vineyard, orchard, and tanks which served for ornament, as well as for the purposes of irrigation, were under their superintendance and direction. In

Egypt, the garden and the fields were both watered by the shadoof, or by buckets carried on a yoke across the shoulders; but there is no appearance of their having used any hydraulic machine similar to the Persian wheel, now so common in the East; nor do the sculptures represent the foot machine mentioned by Philo, which is supposed to be referred to in the sacred writings (Deut. xi. 40.), 'Egypt . . . where thou sowedst thy seed, and wateredst it with thy *foot*, as a garden of herbs.' Some think that this alludes to the mode of stopping the small watercourses with mud, by the foot, and turning off the water into another channel, still adopted in their gardens and fields." (*Ibid.*, vol. ii. p. 5.)

"Besides the date and dôm trees, there were the sycamore fig, pomegranate, olive, peach, almond, persea, *nehq* or *sidr* (*Rhamnus arabica Forsk.*), *mokhayh* or *myxa* (*Cordia Myxa L.*), *Rharoob* (*Ceratonia Siliqua L.* or locust tree), and some others; and among those which bore no fruit, the most remarkable were, the tamarisk (*Tamarix gallica*), and *áthul* (*Tamarix orientalis Forsk.*), *Cassia fistula* and *C. Senna*, the Palma Christi or castorberry tree, myrtle, the *sant*, or acanthus, mimosa, or *Acacia nilotica*, the *sagul* (*Acacia Segal*), *fituch* (*Acacia farnesiana*), *tulh* (*Acacia gummifera*), *libbekh*, (*Acacia Libbeck*, *Mimosa Libbeck L.*), and several other mimosas, besides many trees now only known in the desert, or in the more southerly region of Ethiopia. But I confine myself for the present to the produce of the garden, in connexion with their festivities and domestic wants.

"So fond were the Egyptians of trees and flowers, and of gracing their gardens with all the profusion and variety which cultivation could obtain, that they even exacted a contribution of rare productions from the nations which were tributary to them, and foreigners from distant countries are represented bringing plants among the presents to the Egyptian king. They carried this love for them still further, and not only painted the lotus and other favourite flowers among the fancy devices of their walls, and on the furniture of their houses, on their dresses, chairs, and boxes, on their boats, and, in short, whatever they wished to ornament, but they appear, from Pliny, to have composed artificial flowers, which received the name 'Egyptiæ;' if, indeed, we may be allowed to consider these similar to the 'Hybernæ' he afterwards describes. And it is not improbable that they, like the Romans in their town houses, had representations of gardens, or the rich blossoms of favourite flowers, painted on the stuccoed walls. Wreaths and chaplets were likewise in common use among the Egyptians at a very early period; and, though the lotus was principally preferred for these purposes, many other flowers and leaves were employed, as of the chrysanthemum, acinon, acacia, strychnus, persoluta, anemone, convolvulus, olive, amaricus, xeranthemum, bay tree, and others; and Plutarch tells us that, when Agesilaus visited Egypt, he was so delighted with the chaplets of papyrus sent him by the king, that he took some home when he returned to Sparta." (p. 184.)

"The god of gardens was Khem, supposed to answer to the Grecian Pan. The garden was also under the special protection of Ranno, a goddess frequently represented in the form of an asp, or with a human body and an asp's head. In the sacred sculptures of Egyptian temples, we have frequently the representation of a king breaking up the soil with a hoe, in the presence of this god with an asp's head." (p. 185.)

*Egyptian Villas.*—The Egyptians are said to have paid less attention to their houses than to their tombs; but this seems to have arisen from the latter having reached us in more perfect repair than the former.

"Besides the town houses, the Egyptians had extensive villas, which, with a very commodious mansion, contained spacious gardens, watered by canals communicating with the Nile. They had also tanks of water in different parts of the garden, which served for ornament, as well as for irrigation when the Nile was low; and on these the master of the house occasionally amused himself and his friends by an excursion in a pleasure-boat kept for the purpose. But, like the Orientals of the present day, or like people of the conti-



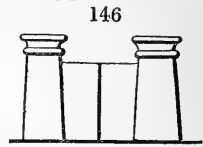
ment of Europe, who are incapable of understanding how the English can row for their amusement, the Egyptians were contented to sit or stand in the boat, while their servants towed it round the lake; and, protected from the sun by a canopy, they felt additional pleasure in the contrast of their own ease with the labour of their menials.

“ They also amused themselves by angling and spearing fish in the ponds within their grounds; and on these occasions they were generally accompanied by a friend, or one or more members of their family.

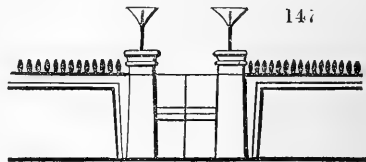
*The Mode of laying out the House and Grounds* varied according to circumstances. “ Part of the garden was laid out in walks shaded with trees, usually planted in rows, and surrounded at the base of the stem with a circular ridge of earth, which, being lower at the centre than at the circumference, retained the water, and directed it more immediately towards the roots. It is difficult to say if they were trimmed into any particular shape, or if their formal appearance in the sculpture is merely owing to a conventional mode of representing them; but, since the pomegranate and some other fruit trees are drawn with spreading and irregular branches, we might suppose that sycamores, and others which presented large masses of foliage, were really trained in that formal manner; though, from the hieroglyphic signifying ‘tree’ having the same shape, it may only be a general character for all trees.” (p. 142.) Some villas were of considerable extent, and, besides the arable land belonging to them, the gardens occupied a very large space, as did the offices and other buildings attached to the house.

“ Some large mansions appear to have been ornamented with propylæa and obelisks, like the temples themselves; it is even possible that part of the building may have been consecrated to religious purposes, as the chapels of other countries, since we find a priest [in the paintings of some of the villas on the tombs] engaged in presenting offerings at the door of the inner chambers; and, indeed, but from the presence of women, the form of the garden, and the style of the porch, we should feel disposed to consider it a temple, rather than a place of abode.

“ The entrances of large villas were generally through folding gates, standing between lofty towers, as in the propylæa of temples, with a small door at each side; and others had merely folding gates, with impostes surmounted by a cornice [as in *fig. 146*, copied from the engraving in Wilkinson’s vol. ii. p. 130.]. A wall of circuit extended round the premises; but the courts of the house, the garden, the offices, and all the other parts of the villa, had each their separate enclosure. The walls were usually built of crude brick; and in damp places, or where within reach of the inundation, the lower part was strengthened by a basement of stone. They were sometimes ornamented with panels and grooved lines, generally stuccoed; and the summit was crowned either with Egyptian battlements, the usual cornice, a row of spikes, in imitation of spear heads, or with some fancy ornament [as in *fig. 147*, from vol. ii. p. 130.].



“ Those villas, or castles, belonging to the kings, which stood on the high road, where they were accustomed to pass either in their hunting or military expeditions, were small and simple, being only intended for their reception during the short stay of a few days; but those erected in an enemy’s country may rather be looked upon as forts than as simple mansions. Many, however, in provinces at a distance from Egypt, were of very large dimensions, and had probably all the conveniences of spacious villas; like those erected in later times by the Ptolemies on the confines of Abyssinia.” (*Ibid.*, vol. ii. p. 132.)



“ It is reasonable to suppose that the Egyptians spent much time in the

cool and shady retirement of their gardens, where, like the Romans, they entertained their friends during the summer season ; and, from the size of some of the kiosks which occur in the paintings of the tombs, we may conclude they were rather intended for this purpose, than for the sole use of the master of the villa. That the gardens were originally laid out with a view to utility, and were chiefly stocked with vegetables for the consumption of the family, is more than probable ; but, as riches and luxury increased, to the simple beds of herbs were added avenues of shady trees, and the usual variety of aromatic plants and ornamental flowers. It then became divided into different parts, distinguished by a peculiar name, according to the purposes for which they were intended ; and the vineyard, orchard, kitchen and flower-garden, had each its own fixed limits, whose dimensions depended on the means or the caprice of its owner. Some of the richer individuals extended still further the range of their villas ; and a park (paradeisos) was added, which, independent of its fishponds and preserves for game, contained many different sections, as the gallinarium for keeping hens, the chenoboscium for geese, the stalls for fattening cattle, and for keeping the wild goats and other animals originally from the desert, whose meat was reckoned among the dainties of the table. It was in these extensive preserves that the rich amused themselves with the pleasures of the chase ; and they also enclosed a considerable space in the desert with net fences, into which the animals were driven for the purpose of being hunted, though the usual custom in those districts was to course in view over the open plains." (*Ibid.*, p. 189.)

*Orchard and Vineyard.*—“ The large gardens were usually divided into different parts ; the principal sections being appropriated to the date and sycamore trees, and to the vineyard. The former might be looked upon as the orchard ; but similar enclosures being also allotted to other trees, they equally lay claim to this name : we cannot, therefore, apply a fixed appellation to any part but the vineyard itself.

“ Gardens are frequently represented in the tombs of Thebes and other parts of Egypt, many of which are remarkable for their extent. The one here introduced is shown to have been surrounded by an embattled wall, with a canal of water passing in front of it, connected with the river. Between the canal and the wall, and parallel to them both, was a shady avenue of various trees ; and about the centre was the entrance, through a lofty door, whose lintel and impost were decorated with hieroglyphic inscriptions, containing the name of the owner of the grounds, who, in this instance, was the king himself. In the gateway were rooms for the porter, and other persons employed about the garden, and, probably, the receiving-room for visitors, whose abrupt admission might be unwelcome ; and, at the back, a gate opened into the vineyard. The vines were trained on a trelliswork, supported by transverse rafters resting on pillars ; and a wall, extending round it, separated this part from the rest of the garden. At the upper end were suites of rooms, on three different stories, and the windows looking upon green trees, and inviting a draught of air, made it a pleasant retirement in the heat of summer. On the outside of the vineyard wall were planted rows of palm trees, which occurred again with the dôms along the whole length of the exterior wall ; four tanks of water, bordered by a grass-plot, where geese were kept, and the delicate flower of the lotus was encouraged to grow, served for the irrigation of the grounds ; and small kiosks, or summer-houses, shaded with trees, stood near the water, and overlooked beds of flowers. The spaces containing the tanks, and the adjoining portions of the garden, were each enclosed by their respective separate walls, and a small subdivision on either side between the large and small tanks, seems to have been reserved for the growth of particular trees, which either required peculiar care, or bore a fruit of superior quality.

“ In all cases, whether the orchard stood apart from, or was united with, the rest of the garden, it was supplied, like the other portions of it, with abundance of water, preserved in spacious reservoirs, on either side of which

stood a row of palms, or an avenue of shady sycamores. Sometimes the orchard and vineyard were not separated by any wall, and figs and other trees were planted within the same limits as the vines. But, if not connected with it, the vineyard was close to the orchard, and they displayed much taste in the mode of training the vines. Rows of columns, supporting wooden rafters, divided the vineyard into numerous avenues, which afforded great facility for communication from one end to the other, and retained a certain degree of moisture at the roots by intercepting the rays of the sun.

“The columns were frequently coloured, and were ornamental as well as useful; but many were simple wooden pillars, supporting, with their forked summits the poles that lay over them. Some vines were allowed to grow as standing bushes, and being kept low, did not require any support; others were formed into a series of bowers; and, from the form of the hieroglyphic signifying vineyard, we may conclude that the most usual method of training them was in bowers, or in avenues formed by rafters and columns. But they do not appear to have attached them to other trees, like the Romans and the modern Italians; nor have the Egyptians of the present day adopted this European custom.

“When the vineyard was enclosed within its own wall of circuit, it frequently had a reservoir of water attached to it, as well as the building which contained the winepress; but the various modes of arranging the vineyard, as well as the other parts of the garden, depended, of course, on the taste of each individual, or the nature of the ground. Great care was taken to preserve the clusters from the intrusion of birds; and boys were constantly employed about the season of the vintage to frighten them with a sling and the sound of the voice. When the grapes were gathered, the bunches were carefully put into deep wicker baskets, which men carried, either on their head or shoulders, or slung upon the yoke, to the winepress; but, when intended for eating, they were put, like other fruits, into flat open baskets, and generally covered with leaves of the palm, vine, or other trees. These flat baskets were of wickerwork, and similar, no doubt, to those of the present day used at Cairo for the same purpose, which are made of osiers or common twigs. Monkeys appear to have been trained to assist in gathering the fruit, and the Egyptians represent them in the sculptures handing down figs from the sycamore trees to the gardeners below; but, as might be expected, these animals amply repaid themselves for the trouble imposed upon them, and the artist has not failed to show how much more they consulted their own wishes than those of their employers.

“Many animals were tamed in Egypt for various purposes, as the lion, leopard, gazelle, baboon, crocodile, and others; and in the Jemma country, which lies to the south of Abyssinia, monkeys are still taught several useful accomplishments. Among them is that of officiating as torch-bearers at a supper party; and seated in a row, on a raised bench, they hold the lights until the departure of the guests, and patiently await their own repast as a reward for their services. Sometimes a refractory subject fails in his accustomed duty, and the harmony of the party is for a moment disturbed, particularly if an unruly monkey throws his lighted torch into the midst of the unsuspecting guests; but the stick, and privation of food, are the punishments of the offender; and it is by these persuasive arguments alone that they are prevailed upon to perform their duty in so delicate an office.

“After the vintage was over, they allowed the birds to browse upon the vines which grew as standing bushes; and the season of the year when the grapes ripened in Egypt was the month Epiphi, towards the end of June or the commencement of July. Some have pretended to doubt that the vine was commonly cultivated, or even grown, in Egypt; but the frequent notice of it and of Egyptian wine in the scriptures, and the authority of ancient writers, sufficiently answer those objections; and the regrets of the Israelites on leaving the vines of Egypt prove them to have been very abundant, since even people in the condition of slaves could procure the fruit.” (*Ibid.*, vol. ii. p. 152.)

"The winepress was of different kinds : a bag in which the grapes were put and squeezed by means of two poles turning in contrary directions, a vase being placed below to receive the falling juice ; or a bag, supported in a frame in a horizontal position, one end of the bag fixed, and the other passing through a hole on the opposite side, this last end being twisted by means of a rod turned with the hand. In the Thebaid, the grapes were generally pressed by the feet. Some of the presses were very ornamental, and are beautifully represented in the engravings. The foot-press of the Romans bore a strong resemblance to that of the Egyptians. After the wine was fermented, it was poured into earthenware jars, with or without handles, like the Roman amphoræ. These were closed with a lid, resembling an inverted saucer, covered with liquid clay, pitch, or mortar, stamped with a seal, and were then removed from the wine-house, and placed upright in the wine-cellar. The Egyptians had several kinds of wine ; but that of Mareotis was the most esteemed, and in the greatest quantity. It is described as white, of excellent quality, sweet and light, with a fragrant bouquet, by no means astringent, or affecting the head." (Vol. ii. p. 161.)

"The Fruit Trees cultivated by the ancient Egyptians were chiefly palms, more especially the date ; but they had also figs, vines, pomegranates, the sycamore fig, the myxa (*Cordia Myxa L.*), the olive, peach, almond, locust, with a variety of others." (Vol. ii. p. 182.)

"The houses and grounds of the Egyptians were superintended by stewards, who regulated the tillage of the farm, received the landlord's proportion of the produce, and, when necessary, punished the peasants who laboured on the estate." (Vol. ii. p. 366.)

## MISCELLANEOUS INTELLIGENCE.

### ART. I. General Notices.

*PATENT flattened Crown Glass.* — By means of this glass, in the ridge and furrow mode of roofing invented by Mr. Paxton, a very great improvement may be made in the construction of hot-houses, particularly botanic stoves. The patent flattened glass is so much thicker than the common crown glass, that it is in no danger of being broken by hail storms, even when used in panes 8 or 10 inches wide ; and, what deserves particular attention is, that these panes may be made 40 in. long at the same cost per foot as ordinary-sized panes. Hence, if a roof is constructed in the ridge and furrow manner, with the sides of the ridge not more than 40 in. in length, there will be no lap at all ; and thus a botanic stove or pinery may be constructed absolutely air-tight, and much heat, which now escapes between the panes, saved. These long panes will also be of great use in glazing verandas, and even common flat-roofed houses, sashes for pits, hot-bed frames, &c. The cost is from 1s. 3d. to 3s. per foot, according to the width of the pane, and the thickness of the glass. The immense conservatory at Chatsworth, and the curvilinear iron house now erecting in the Horticultural Society's Garden, are being glazed with this description of glass. We have also lately designed a veranda upwards of 300 ft. in length, which will be so glazed. — *Cond.*

*Setting the Blossoms of Stillwell's Sweetwater Grape* is readily effected by brushing them over, when fully expanded, with a camel-hair pencil. This is practised by Mr. Pond, gardener to Lady Hood, at Whitly Abbey, near Coventry, with the greatest success. Stillwell's sweetwater will set best at 60°, while the muscat of Alexandria requires from 70° to 75°. — *W. Brown. Merevale, Warwickshire, Sept. 1839.*

*Increasing the Number of Flowers produced by Prímula sinénsis.* — This is done by pinching off the first crop of flowers when they appear in autumn, when the second crop will come out much stronger. Practised with the greatest success by Mr. Dowel, gardener to Sir George Chetwynd, Grendon, near Atherstone. — *W. Brown. Merevale, Warwickshire, Sept. 1839.*

*Filling an Ice-House.* — A pond, in the form of a parallelogram, somewhat wider at one end than at the other, is most convenient. A horse and cart, and four men, with two sieves, a mallet with a long handle, two two-pronged forks, and a hook at the end of a long stick, are all that is necessary. The cart is placed at one end; one man draws the ice forward with the hooked stick; another breaks it in small pieces with the mallet, and two throw it into the cart, each lifting it with a broad-meshed sieve tied to the end of a two-pronged fork. Four loads in an hour are procured in this way. — *Idem.*

*Forming artificial Climates.* — In the *Philosophical Magazine* for November, 1830, is a paper on this subject by Mr. J. S. Langton. The use of these is intended to save the expense of travelling into foreign countries. A dry and airy situation near the metropolis is supposed to be chosen; a square of buildings, not less than 300 ft. on a side, to be built on it; and the area within covered with glass, at the same height from the ground as the roofs of the buildings. Hollow cast-iron columns are to support this roof, and serve, at the same time, as spouts for conveying down from it the rain water; "and their slight variations of length from alternations of temperature, instead of being a disadvantage, might, on the contrary, be used as a self-acting means of regulating the quantity of ventilation, by having many of the glazed frames swung on their centres, and firmly connecting the short arms of levers attached to them with the bases of the columns, by long rods of wood, or other material not subject to practical variations of length by moderate changes of temperature; the difference of length thus obtained in the present case would be about one hundredth of an inch for every three degrees by Fahrenheit's thermometer; a maximum of height is obtained by this material, with a minimum of diameter." Upon the tops of columns 100 ft. high, there would be no more difficulty in placing detached roofs of iron or other material, additional labour and scaffolding excepted, than there would be in placing such roofs on the ground beneath. If wood were used for the frames of the sashes, the expense of keeping up the required temperature would be about 8 per cent less than if iron were used. Supposing the temperature to be kept up to about 52° during the winter months, and that no more ventilation is allowed in very cold weather than what escapes between the laps of the glass when very well fitted, then each foot of glazed surface would require about one fourth of a bushel of coals per annum.

There can be no difficulty in the creation of artificial climates, as far as mere temperature is concerned. This is abundantly proved by the success of gardeners with tropical flowers and fruits; but the difficulty, it appears to us, with reference to habitations for man, lies in providing dry air within when the exterior air is moist, and also in changing the air, without admitting the exterior air, and whatever of moisture it might be charged with. These difficulties may, probably, be overcome by keeping reservoirs of dry air, powerfully condensed, and drawing supplies from them when it might not be deemed advisable to admit the exterior air. Mr. Langton proposes to have "shrubbery" in the space roofed in, and to have vines under the roof, which vines, he says, may be fairly expected to produce fruit to no inconsiderable amount. We confess we do not believe it possible to combine a proper artificial climate for vines, shrubbery, or any description of plants whatever, which should, at the same time, be suitable for the human species. Every one must be sensible of this whose sitting-room has opened into a conservatory. We submit these remarks for the consideration of Mr. Langton, whose scheme, with such amelioration as it may be found susceptible of, we should be most happy to see carried into execution. Mr. Langton will find from our *Treatise on Hot-houses*, published so long ago as 1806, and also from different parts of the *Encyclopædia of Gardening*, that we have long entertained similar ideas; as did the late Dr. Anderson, author of *Rêcreations in Agriculture and Natural History*. — *Cond.*

*Irregularity of the Organs of Vegetables.* — On the 6th of June, M. Dutrochet communicated some observations on this subject, which he considers as presenting a phenomenon similar to that which he has observed in some

animals, viz. an invariable abortion of some of the parts, so that these plants are, in fact, consistent or perpetually recurring monstrosities. In an alpine cytisus, with terminal flowers, M. Dutrochet observed six petals, four disposed in a cruciform manner, and above them two contiguous petals placed alternately. The manner in which these last were placed proves that there must have been two others which have become abortions, so that the papilionaceous flowers were originally regular flowers, having eight petals disposed in two ranges alternately. Three of these petals constantly become abortions, and the five remaining ones form the standard, the two wings, and the two pieces of the keel. Irregular flowers are always lateral; when by chance they become terminal they resume their original regularity, because they have then equal room for development on every side. (*Jour. R. Inst.*)

*The Tanning Principle* has been extracted from the common hemlock, by drying it, chopping it to pieces, boiling or steaming it, and evaporating the extract. (*Newton's Journal*, vol. ix. p. 480.)

*Husking the Palm of Chile.*—A curious method is employed to free the nut from the green husk in which it is enveloped; a process that was formerly attended with great loss of time and labour. A number of cows and oxen are driven into an enclosure, where a quantity of the fruit is spread, and, being very fond of the husk, they immediately begin to feed on the fruit, only slightly masticating it in the first instance, and swallowing the whole; afterwards, while chewing the cud, the nuts are rejected; and, when the meal is finished, a heap of them is found before each of the animals, perfectly free from the husk, the cattle being thus supplied with food at a season when little grass remains on the hills, at the same time that they effectually perform a very useful operation. (*Botanical Miscellany.*)

*The Culture of Cabbage* has undergone a great change in the neighbourhood of London within the last seven years. Formerly the most approved practice was to plant a crop in August or September, another in February or March, and a third in April or May. Now only one crop is planted in September. This is fit for use in the following May and June; and the second shoots, produced by the stools after the first heads are cut off, furnish abundance of cabbages during the remainder of the season. In this way, ground, anxiety, and labour are saved, and a greater certainty of supply is produced. I refer you to the Royal Kitchen-Gardens at Kew, where this method is practised with complete success by the present excellent kitchen-gardener there, Mr. Aldridge. The same mode is also practised at Bromley Hill, in Kent; and at Ashridge, near Tring, in Hertfordshire. The kind of cabbage generally planted for this purpose is the Peignton, Penton, or Vanack, which will continue producing heads fit for use, even while it is flowering and ripening seeds. I believe, however, that any kind of free-growing cabbage may be used; only some kinds require to be well watered in very dry weather, which is not the case with the Vanack.—*John Sims. Brentford, Sept. 1839.*

*Fastening Trees to Walls.*—Possibly you may entirely disapprove of the following mode of fastening fruit trees to a wall, which, it seems, was rather prevalent about 1722. At all events, if you can spare a short space from your crowded pages, it may be curious to preserve what was once recommended by a gardener so eminent in his day as Stephen Switzer, from whose *Practical Fruit-Gardener* the following extract is taken.—*A Constant Reader. June, 1829.*

“The best way of fastening trees to a wall is by little round wooden pegs, made of the heart of oak, driven into the wall between the bricks, to which may be tied all the small branches, with the juncus or small rush that grows in watery places; and all the great boughs, requiring more strength, may, with small withies made of osiers or basket-rods, be tied to large wooden pegs, that are here and there interspersed in the wall, where occasion shall require. The conveniences of this method will be found to be, that as soon as the fruit boughs swell out to the extent of the rush or withy, that band will easily give way, and not pinch or damage the tree, and the pegs of wood

also, being round, will not gall or fret the young branches, as rusty nails will, with their square edges. This method, here recommended, is not speculative only, but has been practised some years in those noble and magnificent gardens belonging to the Duke of Montague, at Bowden, in Northamptonshire, though not the wooden pegs, this being what has been since tried with success; and this method has this further to recommend it, that when the pegs are once fixed (which is much cheaper than nails too) they need not be renewed for many years; whereas nails, growing rusty, canker the tree, and by their being pulled out and driven often in, spoil the wall to that degree, that no nail will stick in it. Moreover, the rushes are a much less expense, as well as much less dangerous to the tree than shreds, as being less apt to harbour insects and vermin; and are, above all, useful in peach trees, which may by these means be in an instant of time unlaced from top to bottom, and have such a new disposition given to them as the natural shape of the trees require."

*To make Paper from the inner Bark of Mòrus papyrifera.* — The tree, if it is to be used for making paper, should be cut down in the beginning of May, or a little later, when it is in full sap; the branches, after being cut off, may be coated over with any cement which will exclude the air. The bark, worked while fresh, acquires a particular kind of glue, and a portion worked early in the morning, may be made up as paper in the evening. According to the experiments of Johannot, the paper contracts in the frames, and it is the alburnum which is peculiarly fit for it. (*Kæmpf. Amœnit.*, 471.; and *Taschenbuch für Gartenfreunde*, 1706, p. 186.) — *H. Carlsruhe, May 20. 1829.*

*Cloth from the Nettle and the Bramble.* — At Nissa, near Alexandria, in the north of Italy, they manufacture a very excellent cloth from the fibre of the common perennial nettle (*Urtica dioica*); but I find that the fibre in the bramble (*Rubus*), in point of strength, is very far superior, although the tissue might be less beautiful. (*J. Murray, in Newton's Journal*, vol. iii. p. 129.)

*The Marc of Grapes,* after being distilled for the purpose of separating the alcohol, is an important assistant to oak bark in tanning leather. The skins being prepared in the usual manner, they are placed in pits with the marc, in the place of bark. In about thirty-five or forty days' time the process is completed. The expected advantages are, shorter time, reduction of the price of oak bark, a more agreeable odour of the leather than that given by oak bark, and greater strength. (*Recueil Industriel.*)

*Bone Dust.* — The effects produced from bone dust, in the cultivation of the soil, are really astonishing. A gentleman who used the dust of boiled bones on a very dry soil, declares that its effects were visible three weeks afterwards. Boiled bones were but half the price of other bones, while they came much sooner into operation; and a friend had assured him, that a field which he had dusted five years ago with boiled bones, was now quite as good as in the first year. (*Anglo-Germanic Advertiser*, as quoted into the *Aberdeen Journal* of Nov. 14. 1832.)

*Regenerating old Pasture.* — You once took some notice of my accidental discovery of a mode of renewing old pasture, when the moss and coarse herbage had got the better of the finer grasses. Since I wrote to you upon this subject, I have found the field treated in the way I mentioned (*viz.*, by paring up the turf with a paring spade, and laying by the turf, to be again replaced after the subsoil has been stirred or loosened by ploughing or harrowing), after four years' experience, to be, by the addition of a little lime ashes, so much improved, that this field now keeps fifteen cattle fully better than it did ten in its former state: the land had been in pasture forty years. The coarse grasses and moss being completely eradicated, the improvement is fully more than equal to 1*l.* an acre; at an expense of less than 3*l.* per acre, for the paring, ploughing, harrowing, and laying down of the turf again. No doubt the pasture is much improved by the addition of a top dressing of lime ashes; and I am of opinion, from what has taken place in pasture ground in other parts of my property, that, by a top dressing of lime of from 80 to 200 bushels per acre (the

lime to be applied in greater or smaller quantities, according to the roughness or abundance of coarse herbage), an addition is made to the annual value of the pasture, of fully 8s. or 10s. per acre, which has been confirmed to me in the letting of pasture land by auction, annually, to drovers. — *C. G. Stuart Menteth.*

*A Hint as to Trenching, and the Use of Coal Ashes*, referred to by Mr. Gorrie, in Vol. VI. p. 45. — It is therefore of the greatest importance, wherever a garden or orchard is to be planted, if the ground be under grass, to have it pared, burnt, and fallowed, previously to trenching, by which means a fund of excellent manure is obtained and incorporated with the soil; whereas, to trench down a soil with much grass beyond the action of the weather, will increase the damp arising from a wet bottom, by forming there a stratum similar to that of peat moss. This, I have had occasion to suspect, is very detrimental to the roots of trees. Having attached such importance to soil and vegetable ashes, I trust I shall not be understood as applying the same to coal ashes, from which I have seen the most pernicious effects when applied in quantities to garden ground. It frequently happens, when a garden has been long and severely cropped, or through the application of unsuitable manure, that the soil becomes quite sterile and barren. Composts of fresh soils may be advantageously applied to recover its fertility; but where moss earth, of a dry loamy nature, can be got, a less quantity of it will be equally serviceable; even peat moss, when exposed in a heap for five or six months, and well broken and turned over, will be found of great advantage. The good effects of both have been fully experienced by myself, as well as others, in this neighbourhood. (*T. Bishop, Gardener, Methven Castle, in Caledonian Hort. Mem.*, vol. i. p. 447.)

*Hardening Gravel Walks.* — Our friend, Dr. Jamieson, of Wyke House Academy, sent us a communication some years ago on the subject of hardening garden walks by forming them of road stuff mixed with tar or gas liquor. Colonel Macerone has lately directed our attention to this subject, as treated by him in the *Mechanic's Magazine*, vol. iv. p. 864., from which we make the following extract: —

“Roman cement, when exposed to the action of the air and rain, absorbs water in such quantity as to be penetrated quite through. Decomposition is assisted in the shade by green mouldy vegetations, and still more mischief is done by the absorbed water expanding with the frost. Let any person observe the side of a cement-covered house, after it has been exposed to the rain, they will find that it will take some days of fine weather to extract the water, and restore it to the same colour with the sheltered part.

“We have numerous examples in nature of animal gelatinous matter forming in combination with aluminous calcareous earths, and even siliceous sands, substances so hard and compact as to strike fire with steel. In some lumular limestones it is very easy to distinguish the parts which have received the animal matter of the shellfish, from their superior hardness, and an agatised translucent appearance. I do not pretend that, by any artificial means, we can make agate or flint; but I have observed such a tendency to agglomerate and harden in all earths that have been saturated with animal gelatine or with oils, as, I think, might, in many cases, be turned to good account.

“I would recommend all plastered walls to be washed over with linseed or whale oil, when at their greatest point of dryness, in fine weather. If size were to be added to the water in laying on the cement, its hardness and durability would be very much increased. Roman cement, mixed up with oil, without water, becomes as hard and compact as marble. But to lay it on in the usual way, and, when perfectly dry, to saturate it with oil or size, will be quite sufficient.

“I have reason to believe that, in default of stone or bricks, artificial stones of sufficient solidity might be substituted, by applying animal gelatine or oil to earths submitted to strong pressure in cast-iron moulds. Chalk, also, cut into regular shapes, and saturated with these substances or with coal tar, will



become sufficiently hard to answer every purpose of building. If the latter fluid be used, it will, moreover, insure that venerable sable hue treated of in the preceding hint. Any kind of mortar may be rendered very hard and durable by these means, and furnish an excellent arched coping for a wall. The broth from the great boilings of horses for dogs' meat might be very advantageously employed, by mixing it with mortar, plaster, &c., or to wash walls with.

"In a public walk at Naples, the ground of which is principally composed of broken tuffa, containing alumine and silex, a few drops of oil have occasionally fallen from the lamps, or been spilt by the lamplighters. This small quantity of oil occasioned so great an induration, and the garden being regularly swept, that in process of time little hemispherical hillocks were formed under each lamp, of such consistency as to resist the spade and the pickaxe. Some of them, quite hard enough for building, I saw taken out, like corns as it were, by digging around and under them.

"About a year ago I poured a quantity of coal tar upon a heap of road scrapings, which, when removed six months after, was much harder than a mass of solid chalk. A walk made of gravel and road scrapings, to which I also applied coal tar, became as hard as a rock." (*Mech. Mag.*, vol. iv. p. 364, 365.)

*The important Influence of the Air we breathe on the general System*, we do not believe to be at all understood, or duly impressed, either on those who build houses, or those who live in them. We know, experimentally, the astonishing difference on our health and spirits, between breathing the air of a low humid situation, or one pent up by trees and bushes, and that of another situation, high, dry, open, and airy; as well as the difference between breathing in a small, close, or crowded, and a large and well aired, room; and we are anxious to induce our readers to reflect on the subject. To those who have leisure and means, we would recommend Clark *On the Influence of Climate in the Prevention and Cure of Chronic Diseases*; and Holland's *Experimental Enquiry into the Laws of Animal Life*. The latter author considers air as life. In an excellent notice of the work in the *Scotsman* (Aug. 12.), it is stated: "In our author's opinion, the mind has only one way of communicating its influence to the body, namely, through the function of respiration. He holds that breathing, or something similar to it, is the primary source of the continuance of existence in the whole animal and vegetable creation; that what excites or depresses the respiratory function, excites or depresses the whole system; that the great object attained by respiration, and especially by the expiratory part of the operation, is the due oxygenation of the blood, on which its healthy and complete circulation depends; that vitality is in the blood, and dependent on the preservation of certain qualities or combinations in its constituent parts, which again depend upon respiration."—*Cond.*

*Pecuniary Charity*.—A high estimate of pecuniary charity in the scale of virtues is the result of incivilisation, and a testimony of the barbarity of the governments where it prevails. Where the people are well governed and prosperous, the field for the exercise of this virtue is necessarily limited; but wherever great and terrible inequalities in human condition subsist, charity is a necessary supplement to the defective institutions out of which they arise. In the Christian world, where pecuniary liberality is dignified as a theological virtue, charity stands in the place of many more serviceable and important duties; and much of that energy which should be given to the improvement of the political and statistic condition of the country is wasted in a vain attempt to bolster up bad systems, and to avert by eleemosynary efforts the miseries and vices accumulated by misrule. The high and influential classes are especially prone to fall into this error. Too moral and too religious to be satisfied with the wretchedness by which they are surrounded, yet too selfish, perverse, or indolent, to attempt a thorough removal of its causes, they satisfy their consciences by attempting to relieve in detail the sufferings which their privileges and pretensions produce in the gross; and when they have be-

stowed a small per centage of their overgrown fortunes upon the wretches whom their monopoly of power has impoverished and wronged, they flatter themselves that they have done all which human sympathy or divine injunction requires at their hands. (*Book of the Boudoir, by Lady Morgan, vol. i. p. 322.*)

*An Experimental Hive.*—During the time I have had the care of bees I have paid a great deal of attention to them; have tried some experiments with them; and read much on the subject, a great portion of which reading I have doubted the truth of. But the most interesting thing that I have seen, is a box-hive of my own invention and construction. I cannot here send you the plan of it, but I can describe its use, which is to show the whole of the operations of the queen bee, as well as the workers, from the time they are put in, till the commencement of the following winter, when they are always killed; though I am in hopes that I have now hit upon a plan to keep alive the next swarm that I may have. It is highly interesting, during the summer months, to those who are fond of bees, to watch them in a hive of this kind; to see the queen deposit her eggs, during which time she is surrounded by as many bees as can stand in a circle about the size of a half-crown piece, with their heads towards her (for it rarely happens that a bee turns its back to the queen when close to her); also to watch the workers, as well as a large portion which are always at rest. By means of this hive I have been able to give a flat contradiction to statements which otherwise I could not have done. It is merely a box about 3 ft. long and 1 ft. high, about 3 in. thick, glazed on both sides, with working boxes to correspond fixed on the top. It is placed on a stand in the window of a room, so that I have only to take a seat and watch them at my leisure. — *R. T. Totteridge.*

*Domestic Economy and Cookery.*—We strongly recommend to such of our readers as have not a cookery book, No. 17. of *Chambers' Information for the People*, price three halfpence. It is a complete epitome of all the directions for cookery, &c., required for a family in moderate circumstances. Besides some valuable introductory observations on domestic management generally, on diet, and on cookery, there are directions for roasting twelve different articles; for boiling as many; for making thirteen different soups; for ten different stews; for twelve sorts of pies and dumplings; for eleven different puddings; and for two dozen of miscellaneous dishes, including a Scotch haggis, our favourite dish a haricot of mutton, and various hashes and economical dishes got up from cold meat, bones, &c., at little expense. There are directions given for making nineteen light dishes and confectionery, and thirteen sauces. There are twenty-four different modes given of dressing fish; excellent directions for baking bread, and brewing beer, and also for making ginger beer; a list of provisions in season, for every month in the year; directions for choosing provisions; and, in conclusion, twenty paragraphs of "advice for the economical." The whole is original; and, for a poor man, or a man in moderate circumstances, this three-halfpence worth is, in our opinion, worth all the other cookery books put together, from its conciseness and comprehensiveness. Such cookery ought to be in every man's house who is able and willing to work; no man should be without it, and no one, however rich, need exceed it; for all beyond, as far as health, either to the individual or the body politic, is concerned, is worse than useless. We are glad to find that this epitome contains no directions for making home-made wines, the time and money spent in manufacturing which we consider as entirely thrown away. Let us have a free intercourse with France and Germany, and we shall soon have genuine wines within the reach of every one who desires to drink them. The practice of making jellies, jams, and marmalades, so common in the families of Scotch farmers and gardeners, is disapproved of, on account of the time and money consumed in making them, and the unwholesomeness of the articles. — *Cond.*

## ART. II. Foreign Notices.

## PORTUGAL.

LISBON, Dec. 21. 1834. — Though I do not know much of gardening, and rely chiefly on your indulgence for my communications to the *Architectural Magazine*, yet I must send you a few observations on the vineyards of Portugal, though I have no doubt they are already familiar to many English readers. It is ten years after a new one is planted, before the wine attains its best qualities. The vines continue to bear well for twenty years; but there is no regular and general renewal of them, for, as they become weak or die, they are rooted up, and fresh ones are planted in their places. The stems are allowed to rise only about 3 ft. from the root, and all the shoots are cut away in the winter, leaving only one, or at the most two, to each root. The vines are propagated by layers, leaving all the shoots from a single stem deep in the earth in the winter season. The bearing shoot, which is left on the stem, as mentioned above, is bent, and its extremity tied down to the main stem. One acre of land yields from four to five pipes of wine.

The Villas in the Neighbourhood of Lisbon are generally provided with a veranda, or open gallery, exposed to the cooler aspect of the locality, and are situated in the midst of ornamental grounds. These ornamental grounds form what is called the quinta; this term being used from such grounds originally comprehending about a fifth part of the whole estate. The villa at which Captain B. resides was at one time the property of a Portuguese nobleman. It comprises about a dozen acres of vineyard, and a beautiful shrubbery extending to the edge of a high cliff of calcareous rock overhanging the Tagus. Among the trees in this shrubbery, I observed the *Quercus Ilex*, *Q. Süber*, and *Q. coccifera*, the *Pinus Pináster*, the Portugal laurel, the *Rhámnus*, the *Pistácia*, the myrtle, numerous species of *Cistus*, *Colútea*, *Psoràlea*, &c., all of which appear to be natives. Among what I should conceive to be foreign plants or trees, are the *Mèlia*, or bead tree, the date, the fan palm, the banana, the agave, the ceratonia, and I need not add oranges, lemons, olives, tamarinds, figs, and mulberries.

The wild olive bears a small and not a pulpy fruit, and its branches end in thorns; but, when grafted, the thorns disappear, and the fruit becomes larger and more pulpy. It is customary to split the trunk of the trees whilst young, and to drive wedges in to keep the clefts open.

Oranges and lemons, in Portugal, are not indigenous, but were originally imported from Africa. The climate of Portugal is rather too cold for them; they suffer much in the severer winters, and only do well, at any time, in the lower grounds and more sheltered situations. The tops of the trees are often injured by the cold winds in common winters, especially when they grow at all lofty. Oranges do best when planted rather wide asunder. Lemons are better for being crowded together. The citron is the best stock on which to graft both the lemon and the orange. The plants of both, raised from seed, and never grafted, produce the best crops, both in quantity and quality; but these trees, especially when old, become so thorny, that it is troublesome to gather the fruit. — *J. B. Williams, R. N.*

## RUSSIA.

The Flora of *Novaia Zemlia*. — The plants which are common to Russia and *Novaia Zemlia* are all early flowering in the former country, while in the latter they never succeed in developing all their flowers, and rarely ripen their seed. Indeed, it is hardly comprehensible how some of them, first flowering in the middle of August, can ever mature seeds at all; and M. Baer observed several plants which showed no signs of either flowers or seeds. He was therefore led to suspect that a considerable portion of the flora of *Novaia Zemlia* is of foreign origin, and springs from seeds annually carried thither on the ice. If this hypothesis be well founded, it offers a remarkable illustration of the ever active, yet almost invisible, machinery, by which life and organis-

ation are diffused over our planet. The flora of Novaia Zemlia bears more resemblance to that of the Northern Ural than to that of Finland. It includes all that is known of that of Spitzbergen, besides a few plants which have hitherto been found only in North America.

Among the laws of the vegetable world peculiar to this frozen region, one of the most striking is, that vegetation is confined to the surface of the soil and the lowest portion of the atmosphere, or just to the plane where the two meet. The plants rise but little above the ground, and penetrate a very short way below it. Plants which, in warmer climates, have perpendicular roots, have them here horizontal, and creeping just beneath the surface of the soil. In fact, the flower, only 1 or 2 inches high, feels the reflected warmth from the dry soil; its root keeps likewise near the surface, for, if it penetrated downwards, it would soon approach the perpetual ice. This curious characteristic is most plainly developed in the arborescent plants. The commonest tree of Novaia Zemlia is the *Sàlix polaris*, if that may be called a tree which rises little more than half an inch above the moss in which it seems to nestle; there, from a stem about as thick as a quill, it puts forth a pair of leaves and a catkin. Yet it would be a great mistake to suppose this the entire plant; the tree, in fact, grows along the surface of the ground, barely protruding its little branches through the moss. Another species (*S. reticulata*) rises to a height of 4 or 5 inches; but in this, as well as the *S. lanata*, the giant of these forests, the wood above ground is incomparably less than that which, as stem or root, lies extended on, or buried near, the surface. The latter species rises to a height of 6 or 8 inches; and M. Baer has traced their stems in the ground a length of 10 or 12 feet without finding their termination; and thereupon he remarks that a party shipwrecked on Novaia Zemlia could never hope to collect sufficient fuel from the surface of the ground, but below the surface they would probably find it in abundance.

Not fewer than 90 species of phanerogamic plants, and about half that number of cryptogamic, were collected by M. Baer in Novaia Zemlia. (*Expédition to Novaia Zemlia*, as quoted in the *Athenæum*, No. 560. p. 507.)

#### INDIA.

The *Botanic Garden of Calcutta* was established under the direction of Col. R. Kydd, in March, 1768. This garden was quickly enriched with valuable plants, by means of a correspondence with all the Europeans that had settled in India. There were about 300 species in it, when, in the autumn of 1793, Dr. Roxburgh was charged with its superintendence. That botanist established a more active correspondence, and visited himself the coast of Coromandel, and some other provinces of British India. He succeeded in bringing together 3500 species of plants in the Company's garden, and of this number 1510 were previously unknown, and were named and described by him. This we learn from the catalogue of the garden, printed at Serampore in 1814, under the direction of Dr. W. Carey, Dr. Roxburgh's friend.

This catalogue, which is written on a very contracted scale, makes known the botanical name, the Indian denomination, the native place, and the periods of introduction, flowering, and maturity of each plant. It concludes with an appendix, containing the Indian species not yet introduced into the garden, but known to Dr. Roxburgh.

That gentleman, however, did not confine himself to this brief indication of his labours, but successively sent to the East India Company numerous drawings and descriptions of the vegetables of India; and the Company made a selection of them, which was published under the direction of Sir Joseph Banks, under the title of *Plants of Coromandel*. This magnificent work contains descriptions and coloured figures of 300 species of Indian plants, selected from among those preeminent for beauty or utility. But the very magnificence of this publication rendered it impossible to extend it to the whole of the vegetation of India, and Dr. Roxburgh conceived the project of publishing a flora of that country in a simpler form. Unfortunately, however, his health did not permit him to carry into effect this plan. He retired from

India in 1814, and died in England. The flora of India, however, was not lost to science; for his friend Dr. Carey published two volumes of it at Serampore, and inserted in it, besides the plants described by Dr. Roxburgh, all those which had been successively discovered by himself, Messrs. Wallich, Jack, and other botanists. This work is arranged according to the Linnean system, and contains the first five classes.

After Dr. Roxburgh's death, the superintendence of the Calcutta garden was confided to Dr. Wallich, whose talents and activity, seconded by the protection of the Company, have raised the establishment to a high degree of prosperity. More than 300 gardeners or workmen are attached to it; and the objects more particularly held in view are, the naturalisation and diffusion of useful plants, and the preservation of the rarer vegetables of the different parts of India for study. Numerous travellers, sent out at the expense of the Company, traverse all the countries subject to its domination, and, in concert with the English dispersed over that vast empire, are continually adding to the riches of the Company's garden and collections. Dr. Wallich himself travelled, in 1820, through the country of Nepal, which, being situated at the base of the great Himalayan Mountains, presents a vegetation entirely different from that of Bengal. After this, although labouring under severe diseases caused by fatigue, he visited Penang, Singapore, the kingdom of Ava, and some other parts of India. Besides this, he sent collectors into the districts to which he could not go in person; and by these various means collected a great mass of vegetables, living and dried.

These collections have already enriched the science of botany with numerous discoveries. Several of the plants collected by Dr. Wallich have been inserted in the *Prodromus Floræ Nepalensis* of Don, and in various general works published in Europe. Dr. Wallich himself has, as has been said above, inserted a great number of them in the *Flora Indica*; and has commenced the publication of two works intended to make known the principal discoveries in a more complete manner. The first of these is his *Tentamen Floræ Nepalensis*, which contains the full description, accompanied with a lithographic figure, of the principal vegetables of that country. Two numbers have already appeared, each containing twenty-five plates. Besides its botanical importance, this work deserves notice, from the circumstance of its being the first containing botanical figures lithographed in India, and drawn by native painters. Dr. Wallich's second work, which is much more magnificent than the other, is intended to give descriptions and coloured figures of the rarest plants of Asia. It is to consist of three volumes. The first and second numbers, which have just made their appearance, announce that this collection will be one of the most valuable of which the science has to boast, and will rival the great works of Rheede, Rumphius, and Roxburgh.

Besides the capital works of Roxburgh and Wallich, there are others which the East India Company has encouraged or protected. MM. Kœnich, Heyne, Carey, Patrick, Russel, Rottler, Klein, Wight, Finlayson, &c., have traversed various parts of India, for the purpose of examining its vegetation. For about fifty years back, all the collections of dried plants made by these zealous travellers have been sent to London, and are preserved in the Company's museum. The very immensity of these materials has shown the honourable directors of that institution the impossibility of rendering them useful, without the cooperation of a great number of observers. By a decision remarkable for its bounty and liberality, the Court of Directors has instructed Dr. Wallich, who is now in London, to distribute these valuable collections among the principal botanists of Europe, at the same time taking suitable measures to insure their publication. This liberal distribution has already commenced, and it is likely that, through the generosity of the Company, the whole of the plants collected in India will soon be added to the mass of known vegetables. Their number is estimated at seven or eight thousand species; and it may easily be conceived how many new facts, ideas, and connexions will arise from this immense addition to our botanical knowledge. The East India Com-

pany has thus acquired the most honourable right to the gratitude of the learned of all countries; and we are certain that all the friends of science will applaud this great act of liberality, and will join us in expressing their gratitude. The very manner in which this great operation is performed adds to its utility, and deserves being made known.

All the species of the different collections are arranged under their families and genera by Dr. Wallich, and the principal English botanists, Messrs. Brown, Lindley, Bentham, &c. Each has a number attached to it, and receives a provisory name. Lithographic copies are printed of the lists of these names, accompanied with the designation of the different localities in which the plant has been gathered. All the specimens furnished with one number refer to these lists, and in this manner those who may see them in the different collections in Europe will be certain of their identity with those which are described. By this very simple process, all the uncertainties to which the sight of isolated specimens frequently give rise will be removed.

Each family of plants is sent to the botanist who has given proof of his peculiar fitness for its examination, by the monographs which he has published, commenced, or projected, on it. Thus, to confine ourselves to a few examples which have come to our knowledge, Mr. Brown has got the *Rubiaceæ*, &c.; Mr. G. Bentham the *Caryophyllææ*, *Labiâtæ*, &c.; Mr. Lindley the *Rosâceæ*, &c.; M. DeCandolle the *Umbelliferaæ*, *Caprifoliâceæ*, *Lorântheæ*, &c.; M. Adolphe DeCandolle the *Campanulâceæ*; M. Choisy the *Convôlvuli*, &c. Each of these monographists receives the first disposable duplicates in the part confided to him, and is to make them known to the public. The other specimens are distributed in such a manner as to be divided into collections destined for different countries, and thus contribute, in the most efficient manner, to extend a knowledge of the botany of India.

If the gratitude of naturalists is first due to the Honourable East India Company, it is also due to Dr. Wallich, who superintends this distribution. So far from taking advantage of his situation for reserving to himself the publication of these riches, he only occupies himself in distributing them among his colleagues in the manner most useful for the advancement of natural history. He employs, for the purposes of facilitating the labour of botanists in general, the valuable time which he might employ in his own private labours, and by this proves that he sees glory where it really is, in usefulness. How widely different is this liberal manner of serving the interests of science, from the narrow and despicable jealousies of which the history of literature and science presents but too many examples! If we have thought it our duty to mention this event as an honourable fact in the history of botany, we also love to make it known as a fact honourable to the human heart, as a proof of the progress of civilisation, and of the intimate connexion which is every day becoming more firmly established among enlightened nations. (*Jameson's Journal*, July, 1830.)

---

### ART. III. *Domestic Notices.*

#### ENGLAND.

*A NATIONAL Arboretum.* — We learn with pleasure that a national arboretum in the New Forest is about to be planted by Mr. Page of Southampton. It will be formed upon the national property, under the management of the Woods and Forests, two miles from Lyndhurst, where various soils, with high and low situations, can be selected. We are kindly promised farther information on this arboretum by Mr. Page. — *Cond.*

*A Subscription Botanic Garden* is said to be in contemplation in the neighbourhood of Reading, by appropriating about thirty acres of the grounds of White Knights, known as the Wilderness, for this purpose. (*Gard. Gaz.*, Oct. 12. 1839.) We sincerely hope this design may succeed, and that the numerous

fine specimens of trees and shrubs in the Wilderness may be allowed to attain their full growth, and be admired by thousands, instead of being subjected to the commonplace treatment incident to trees and shrubs, when growing on estates which are to be sold in lots. By means of the railway, White Knights is brought within two hours' ride of London, so that it may be visited any morning between breakfast and dinner, at an expense under twenty shillings. — *Cond.*

*Royal Botanic Society.*—A charter of incorporation has just been granted to this Society “for the promotion of botany in all its branches, and its application to medicine, arts, and manufactures; and also for the formation of extensive botanical and ornamental gardens within the vicinity of the metropolis.” The charter appoints the Duke of Richmond the first president; Mr. Majoribanks the first treasurer; and the Duke of Norfolk, the Earl of Albermarle, Mr. Rushbrook, Philip Barnes, and James de Carle Sowerby, Esqs., the first council. The organisation is similar to that of other scientific societies, and meetings for the discussion of scientific subjects will be held periodically. The anniversary meeting is assigned by the charter for the 1st of January. Steps are in active progress for the completion of the gardens in the Regent's Park, in which exhibitions will be held in the approaching season. (*Court Journal*, Oct. 5.)

*Count Harrach*, an Austrian nobleman who has large estates in Austria, Hungary, and Bohemia, has lately passed some months in this country, viewing gardens and country seats in various parts both of England and Scotland, with a view to the improvement of his own when he returns. The count is the only private nobleman in Austria that keeps a garden director. He is proprietor of Bruck on the Leytha, where there is such an admirable collection of trees; the names and dimensions of many of which are given in our *Arboretum*, as well in the history and geography of trees, p. 150., as in various other parts of the work. The count has purchased a great number of plants, horses, implements, &c.; and taken with him plans and views, prepared by Mr. Lamb, for erecting a magnificent palace, which will contain above ninety rooms, including apartments for a resident clergyman, resident physician, &c. The count has only lately come into possession of his estates on the demise of the late count. The house in England with which the count was most struck was one near Beauvoir Castle, which has been in the course of erection for many years, is of immense size, and in which no two windows are said to be alike; the proprietor, Mr. Gregory, having travelled all over Europe in search of different forms.

*American Nurserymen in England.* — We have already mentioned Mr. Buist of Philadelphia; and since we have seen that gentleman, Mr. Butcham of Rochester, Mr. Bosson from Boston, and, we believe, some others, have called upon us. It is thus highly gratifying to see the increasing taste for gardening in the United States. The above and other nurserymen have stated to us that our publications are often difficult to be purchased in America, and always at a much higher price than is charged for them in England; and they have suggested the advantage that would result to all parties from having a general depôt for our publications in the United States; in which depôt there should always be a stock of them on hand, and whence they might be obtained at the same price as in London. Such a depôt we hope soon to announce as established, at least as far as respects those works which are our own property, viz. the *Gardener's Magazine*, the *Arboretum Britannicum*, the *Hortus Lignosus*, Loudon's edition of *Repton's Landscape-Gardening*, the *Architectural Magazine*, the *Suburban Gardener and Villa Companion*, and the *Encyclopædia of Cottage, Farm, and Villa Architecture.* — *Cond.*

*Mr. Moore, the Curator of the Glasnevin Botanic Garden*, has lately been on a tour in England, inspecting some of the principal public and private gardens. Mr. Moore was for a considerable time botanist to the trigonometrical survey of Ireland, and is thoroughly acquainted with the native plants of the country, as well as with the state of gardening from one end of the island to the other. Mr. Moore has been twelve years in Ireland, and the improvement which he

says has taken place in the country during that period is quite astonishing; nay, even within the last three years the progress is visible. Gardening, he says, is carried to the greatest perfection in the north of Ireland, and more especially in the neighbourhood of Belfast. The grand promoter of horticulture there is Michael Andrews, Esq., of Ardoyne. The Belfast Botanic Garden Mr. Moore describes as fifteen acres in extent, beautifully situated, with an excellent soil, and well managed by Mr. Ferguson. The remaining plant of *Phyllócladus* is in a thriving state, the other being now in the collection of the Rev. T. Williams of Hendon Rectory. On the whole, the account given of the state of gardening and planting in Ireland, by Mr. Moore, is more gratifying than any we have had for some time past. — *Cond.*

*The Weeping Larch at Denham Hall, Suffolk*, the seat of the Earl of Stradbroke (*Arb. Brit.* p. 2358., *Hort. Lig.* 123.), covers a walk, forming an archway, 30 yards in length, and has never yet made an upright shoot. In fact, so perfectly pendulous is it, that its shoots creep along the ground. I received grafts of it three years since, and find that its pendulous character is permanent. It appears to me to be a variety of the red American larch; its shoots are red, and its foliage is of a dark glaucous green. — *T. Rivers. Sawbridge-worth, Sept. 1839.*

The plant of this variety of larch in the Horticultural Society's garden, received from the Earl of Stradbroke when Baron Rous, has a leading shoot as upright as that of any common larch, but the lower branches trail on the ground; and, if encouraged, might probably extend to a great length. The tree, however, is not in a thriving state, and might very well pass for being nothing more than the common larch. — *Cond.*

*Plants lately raised from Seeds in the Birmingham Botanic Garden.* — In 1837, *Lupinus Barkèria* and *Begonia macrophylla*, from Mexico. In 1838, *Impatiens* sp. from Himalaya; *Arenaria grandiflora*, from Russia. In 1839, *Pinus Hartwègii*, *P. devoniàna*, *P. Pseudo-Stròbus*, *P. pátula*, *P. Teocòte*, *Abies religiòsa*, *Bétula jorullàna*, *Arctostáphylos púngens*, *Cotoneáster denticulàta*, from Mexico; *Láthyus canéscens*, from Buenos Ayres; and *Cheilánthus farinòsa*, from the East Indies. — *D. C. Sept. 1839.*

*Refuse Apples as Manure.* — It may probably be in the recollection of some of our readers, that, owing to the superabundance of the crop of apples last year in the orchard of Mr. Bryer of Leece, in Low Furness, Mr. Bryer tilled a field, which he purposed sowing with wheat, with the refuse or unsaleable part of his apple crop. The result shows the value of the experiment, though it is one, we presume, which the farmer will seldom be able to make. The wheat promises a good return, being the best crop, with one exception, in that far-famed corn district. (*Cumberland Packet*, July 6. 1830.) — *M. Saul.*

#### SCOTLAND.

*The Highland Society of Scotland.* — The newspaper reports, given from time to time, of the meetings of this Society show the rapid progress that is making in agricultural improvement in every part of Scotland; and though we chiefly store up the ideas that we derive from these reports for supplementary matter to our *Encyclopædias of Agriculture* and of *Cottage, Farm, and Villa Architecture*, yet there are some things so far connected with gardening, that we consider it our duty to notice them in this Magazine. At the meeting at Inverness on October 3., among the subjects discussed after dinner, thorough draining was one.

“Colonel Maclean, of Ardgor, asked whether in those parts of the country where stones could be had cheaper than tiles, they should not be preferred?”

“The Marquess of Tweeddale. ‘In my experience, every drain made with stones has choked up, and tile draining is the only efficient system. I cannot give a preference to stones on any terms. Whatever drain does not filter the water is objectionable.’”

“Major Cumming Bruce then questioned the marquess more minutely as to this opinion. He had himself gone to considerable expense in stone draining,



relying on the opinion expressed by Mr. Smith of Deanston, a high authority on the subject. Mr. Smith had stated in his book [reviewed in Vol. IX. p. 448.], that drains made of stones broken small enough were better than tile drains. Now, he would beg to ask the noble marquess, whether in those drains which he had described as having been choked, the stones were broken small enough.

“The Marquess of Tweeddale replied that the practice of draining by means of tiles was not known when Mr. Smith wrote his book. He admitted that he had not read Mr. Smith’s book, but judged of it from what he had seen in agricultural publications.

“Major Cumming Bruce repeated the question — ‘Is a drain, say of 30 in. depth, of stones broken small enough, sufficient for carrying off the water?’

“The marquess, in reply, said that every drain on his estate which choked was built of stones as nearly of the same size as possible, and he believed it would be as profitable to throw the money into the sea, as to lay it out on stone drains.

“Mr. Ainslie of St. Colme said that Mr. Smith of Deanston uniformly employed stones, and he knew it from personal communication with Mr. Smith, as well as from his own experience, that in certain soils tiles are quite insufficient, and cannot be used. This is particularly the case with sandy or moorish soils, such as those on which Major Cumming Bruce is now employing them. On clay soils tiles may be used with more advantage than stones.” (*Inverness Courier*. Oct. 5. 1839.)

The advantages which tile drains have over stone drains, in all loamy soils at least, if not in all soils whatever, in our opinion are two; and these render tile draining so decidedly preferable for every kind of garden and pleasure-ground purpose, that, when it is fully known to gardeners, we are persuaded that no other mode will be used by them. First, if the semicylindrical tile is either laid on a flat tile, or on a semicylindrical tile turned upside down, the drain or tunnel so formed will never choke up; and, secondly, if, after the tiles are laid, they are covered either with sand, fine gravel, or surface soil (not subsoil), this covering serves as a filter, and prevents either fine matter that would choke up the drain, or fluid matter that might serve as liquid manure to the plants, from entering it. For draining parks, pleasure-grounds, walks, and approach roads of every kind, no mode of draining hitherto devised is so truly scientific or so durable; and we may add that though the cost in some cases will be more in the first instance, yet from the great durability of such drains, they will in every case be found cheaper in the long run. In some walks now laying out under our direction in Derbyshire, this kind of drain has been used, though in a stone country; the experience of practical men having already determined it to be preferable to the old mode by broken stones. Three fourths of the arable lands of England would require to be drained in this manner; and should any circumstance occur to oblige the English country gentlemen to make the most of their estates, this will be one of the first steps taken to improve them.

*A Mallet, with a Hoe attached on the one Side, and a Pick on the other*, the invention of Mr. John Gray, gardener to W. F. Campbell, Esq., M.P., Islay, received the Society’s silver medal, and will doubtless be a useful implement in certain soils and situations: in hoeing potatoes in coarse land, for example. We should be much obliged to Mr. Gray for some notice of this implement, as well as of the pump for liquid manure mentioned in the next paragraph; unless, indeed, the Highland Society intends to publish engravings and descriptions of them in their *Transactions*.

*A wooden Pump for liquid Manure*, also invented by Mr. Gray, will be a valuable machine for the cottager, and we shall be most anxious to see such an account of it as we can render available for the supplement which we are now preparing to our *Encyclopædia of Cottage, Farm, and Villa Architecture and Furniture*.

*Plants of the Norway Maple, and of the true Highland Pine*, were exhibited

by our correspondent Mr. Gregor of Forres; and plants of the gigantic flax, and of *Mâdia sativa*, by Mr. Lawson of Edinburgh. A variety of drumhead cabbage was recommended by the judges, for cottagers living in high situations. — *Cond.*

*Country Seats in the Neighbourhood of Inverness.* — *Cantray, the Seat of General Sir John Rose*, was laid out by the grandfather of that gentleman; who, though he had chiefly resided in London, yet astonished his neighbour by the judgment and spirit with which he entered upon a course of extensive agricultural improvement. (*Inverness Courier*, Sept. 18. 1839.)

*Holm*, built by the late Colonel Hugh Rose, has a lawn of about fifty acres in extent, which descends close to the river, with the walks finely laid out. The present proprietor, General Sir John Rose, continues the system of embellishment begun by his predecessor. (*Ibid.*)

*Kilravock* is a castellated pile, with a strong square tower built in 1460. The structure altogether resembles a French château, high-roofed, and blending the manor-house with the castle. This family have been great planters for many generations, and accordingly the grounds abound in large trees; one of which, admired by Burns when he visited Kilravock in 1787, is known as Burns's Oak. The trunk near the ground is about 15 ft. in circumference. At the time Burns visited Kilravock, it was occupied by the proprietress Mrs. Rose; but the representative of this family is now in India. The castle, however, has fortunately, for the last nine or ten years, been occupied by an English lady, Mrs. Campbell, who has evinced no less taste than munificence in adorning the ancient château, and heightening the natural beauties of the spot. In addition to many substantial improvements in building, draining, planting, &c., which have been carried into effect by this lady, a new approach has been formed from the east, winding up the river side, and another carriage road to the castle has been made from the west, superseding the stiff, abrupt, straight road which formerly led down to it. The lawn has been extended and improved; unsightly walls and incumbrances have been displaced; and a flower-garden has been constructed of the most exquisite description; the smooth shaven turf (on which no leaf nor twiglet is suffered to intrude) being studded with beds of dahlias and other rich exotics. At the bottom of this floral retreat, which forms a continuation of the lawn, is the "fairly walk." It is shaded by splendid lime and beech trees, and a chestnut of great dimensions, such as *Salvator Rosa* would have delighted to paint. Mary Queen of Scots stopped at Kilravock on her return from Inverness, in the course of her hurried journey to the north in 1562. The proprietor at this time was a Hugh or Hutcheon Rose, the eighth laird. (*Ibid.*)

*Cawdor Castle* is about three miles beyond Kilravock, and is too well known to require commemoration. Its noble situation on the banks of a rapid stream, encompassed by trees of gigantic size, with the varied and beautiful walks that intersect the grounds, extending to ten miles in length, afford ample materials for the pencil of artists, and the notebooks of tourists. "The whole of Cawdor Castle," says Mr. Fraser Tytler, "is peculiarly calculated to impress the mind with a retrospect of past ages, feudal customs, and deeds of darkness. Its iron-grated doors, its ancient tapestry hanging loosely over secret doors and hidden passages, its winding staircases, its rattling draw-bridge, all conspire to excite the most gloomy imagery in the mind." The tower is about four centuries old, and is built on a rock, from which springs the well-known hawthorn tree inside the tower, shooting up its stem to the vaulted roof. This tree was undoubtedly growing before the erection of the tower, and is, perhaps, the oldest hawthorn in Scotland. (*Ibid.*)

*Castle Stewart, a Seat of the Earl of Moray, near Inverness*, was built about 1620. It is a capacious and lordly pile, well worthy of restoration. About twelve or fifteen years since, Earl Moray had the misfortune to have a local factor, who waged war with all the woods. He cut down the forest trees, destroyed the orchard, ploughed up the lawn, and left Castle Stewart a bare and portionless member of the baronial family. (*Ibid.*)

## IRELAND.

*Newtown Stewart, Co. Tyrone, June 10. 1838.* — In answer to your request, as I am now located in this neighbourhood, I should be happy to give you any information in my power respecting gardens and gardening in these parts, were it possible for me to write anything on the subject deserving notice. The truth is, gardening is an art neither known nor practised in the north-west district of Ulster; nay, I might, perhaps, say, with very few exceptions, in any part of the province. There being no gardens, it is superfluous to add, that gardeners are not encouraged, and, in fact, do not exist. That there are a species of handy labourers, who possess the knowledge necessary to enable them to cultivate the few indispensable culinary vegetables which a landed proprietor requires, I do not mean to deny; but one of these, fairly entitled to the appellation of gardener, I have not had the good fortune to meet with since I last saw our friend Mr. Ellice, of the Palace Gardens, Armagh. — *M.*

ART. IV. *Retrospective Criticism.*

*ERRATA.* — In p. 515. lines 20. and 21. from the bottom, for “C. Knott, Esq.,” read “G. Knott, Esq.,” and for “Boham Lodge” read “Bohun Lodge.”

The *black Italian Poplar* is noticed in p. 433. as *Pópulus monilífera*, whereas, according to your *Hortus Britannicus*, it ought to be *P. akladésca*; an error which you may wish to correct. Perhaps, however, it is not an error; as, since the publication of the *Hortus Britannicus*, you may have discovered that the two trees are the same species; for, on comparing the leaves of the two in my collection, I can see no difference between them. But, however this may be, I am satisfied you will excuse my thus writing to you, for having been a constant reader of your Magazine, from its commencement, as well as of other of your works occasionally, I cannot but know of your desire to avoid even the smallest errors, and your readiness to correct them when pointed out. — *T. C. Sept. 4. 1839.*

The specific name *akladésca* was given to this poplar by Dr. Lindley, some years ago, in his edition of *Donn's Hortus Cantabrigiensis*, under the supposition, we suppose, that it was a species distinct from *P. monilífera*. In our *Arboretum Britannicum*, and in the *Hortus Lignosus*, *P. akladésca* will be found given as a synonyme to *P. monilífera*. The synonymes are so numerous to this and other species of poplar, that they are not given in the *Second Supplement* to the *Hortus Britannicus*, although an exception ought doubtless to have been made in favour of *Pópulus akladésca*. — *Cond.*

*Insuring the Prolificacy of the Hautbois Strawberry.* — In p. 472. I observe an account of a method of insuring the prolificacy of the hautbois strawberry. A few years ago I wrote a letter to you describing my method of preserving plants of each sex separately, and, when new plantations were made, to mix them. This plan I have followed ever since, and supplied plants for others to do the same; and, till I saw the above, have never heard of its failure. I do not doubt the truth of J. M.'s statement in p. 472., but I am a great enemy to mixing crops where the same success may be obtained by keeping them distinct. It will, perhaps, be said that one advantage attends the planting of other sorts along with the hautbois strawberry, which is, that the sorts so mixed bear fruit as well as it, whereas the male hautbois runners never do. This is perfectly true, but the advantage is so trifling, and the appearance (at least, in my opinion) so unsightly, that I shall never be induced to adopt the plan, unless it could also improve the size or quality of the fruit; and I think, if J. M. had seen my hautbois this year, he would be inclined to try my plan, although he may “have seen it tried very carefully without the expected success.” I do not pretend to superiority in growing strawberries or any thing else, as where I live the situation and soil are far from favourable for growing

most kinds of fruit, but I certainly have directed my attention very much to growing the hautbois strawberry; and having once published the fact that my plan will insure success, I think when I see it contradicted, it is nothing but right to notice it. Any hint I can give to J. M. I shall be most happy to impart. Should he think proper to apply privately for my address, you are at liberty to give it; and when he comes this way I shall feel a pleasure in walking round the strawberry beds with him. Meanwhile, if he will plant a bed of hautbois with two rows of female plants, about 1 ft. from each other, and one row of males, about 2 ft. apart, I have no doubt he will be perfectly satisfied that what I have stated is correct, provided the season be favourable when in flower, without which neither his plan nor mine can succeed. I always keep two beds for selecting my runners from; and if J. M. has not any (although I have not many), he is perfectly welcome to a few to begin with. — *R. T. Sept. 20. 1839.*

*Corrections for the Hortus Britannicus, Second Additional Supplement.*—*Cytisus Wéldenii*. I am surprised that you should say that this plant is like the common laburnum. Its straight erect racemes, and round pointed leaflets, are very different. I send you some seeds and leaves, &c. [The seeds we gave to Mr. Gordon, who first remarked (*Gardener's Magazine*, vol. xiv. p. 581.) that, in its young state, *C. Wéldenii* had a great resemblance to the purple laburnum. We were of that opinion also; but now that the plant has made shoots of 2 or 3 feet in length, we consider it to be very distinct, independent of the flowers, which, of course, we have not seen.] *Ribes opulifolium Hort. Brit.* p. 703., is a shrub, a native of Carniola, and not of Russia. Baron Sigismund Pronay (*Hort. Brit.*, p. 661.) is a Hungarian nobleman, and not a French nobleman. He has left his fine garden at Hetzendorf, near Vienna, and lives now at Frankfort on the Mayn. — *Baron Jacquín. Vienna, July 26. 1839.*

---

#### ART. V. *Queries and Answers.*

*THE Ribes sanguineum killed from an unknown Cause.* — I am a great admirer of the *Ribes sanguineum*, and have been much disappointed in the loss of two fine plants of it. One, two years ago, in a luxuriant growing state, was suddenly killed, the leaves turned red and crisp, as if burned, and I concluded it must have been the effect of lightning, though no shrubs near it were injured. But this July another has been killed in the same unknown way. Nothing appears amiss in the roots, but it suddenly dried up, exactly in the way the former did. Our subsoil is not good; but, if they had been injured by that, it would have come on gradually, not from one day to another. I hope yourself or your readers may be able to solve this enigma, that I may not lose the plants at present growing, when they are become larger. — *M. D. B. South Wales, Sept. 1839.*

---

#### ART. VI. *Proceedings of the Horticultural Society of London.*

*FEB. 19. 1839.* — *Ordinary Meeting.* Read, the following letter to the secretary from Mr. W. B. Booth, upon the mode of constructing wire fences for training espalier fruit trees upon, and for other purposes.

“ *Carclew, January 29. 1839.*

“ *SIR,* I beg to hand you the following particulars respecting some wire trellises lately erected here, which you may, probably, not deem unworthy of submitting to the notice of the Horticultural Society.

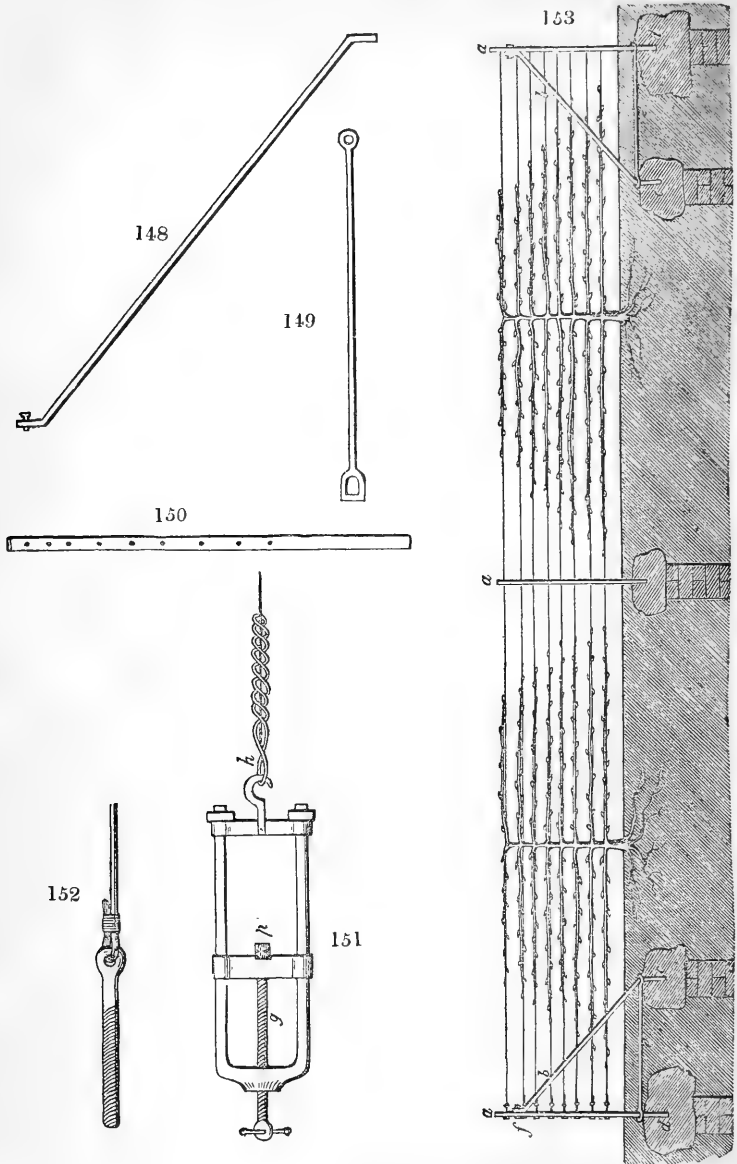
“ The object for which they are intended is the training of espalier fruit trees; and it occurred to me, in the course of erecting some wire fencing to divide a portion of the park, that a similar kind of erection might be advantageously introduced into the kitchen-garden, which would answer the same

purpose as the expensive wooden or cast-iron trellises usually met with in those places where the espalier mode of training is adopted. I accordingly submitted the plan to Sir Charles Lemon, who has since had it carried into execution to a considerable extent.

“Wire erections of the kind I am about to describe are not uncommon, I believe, as fences, in some parts of the kingdom; but in Cornwall it is only within the last few years they have been introduced. Mr. Gilpin, in his excellent *Hints on Landscape-Gardening*, p. 217., has noticed the wire fence as being best suited for those parts near to the house, or to the approach, but he has not shown the manner in which it may be erected. The accompanying sketches and details will, I trust, supply this deficiency, and enable any one who may be desirous of erecting a wire fence or trellis to do so, with the assistance of a mason and blacksmith, at a very moderate expense. The wire used is known as No. 32. It is about a quarter of an inch in diameter, and is put up in large coils. Each wire measures from 115 ft. to 120 ft. in length. The main upright posts (*fig. 153. a a*) are of iron,  $1\frac{1}{4}$  in. square, and from  $5\frac{1}{2}$  ft. to 6 ft. high, with holes 6 or 7 inches apart for receiving the small screws and nuts, to which the wires are attached in the way shown at *fig. 152*. At the opposite end the wire is secured by being bent a little at the point, and having a small wedge driven over it in each of the holes of the upright. Both these main posts are  $4\frac{1}{2}$  ft. above the level of the ground, and are fixed beneath the surface in large rough blocks of stone (*d e*), with iron wedges, which are more convenient, and answer the purpose quite as well as if they were run in with lead. The stay-bar is round, and  $1\frac{1}{4}$  in. in diameter. It varies in length according to the inclination of the ground, but when the latter is nearly level it is about 7 ft. long. The upper end is flattened, and beveled, so as to square with the upright, to which it is fixed by means of a screw at *f*. The lower end is only a little bent, that it may fit into a somewhat smaller block of stone (*e*) than the one at *d*. The connecting bar (*c*) is square or round, and need not exceed an inch in either case. It will also vary in length, according to circumstances. On a nearly level surface it must be about 5 ft. long, and have an eye at each end large enough for the end of the post and stay to go through. In addition to this, there are uprights of one-inch flat bar by half an inch in thickness fixed in stone, at 30 or 40 ft. apart, or even nearer if necessary, for the purpose of stiffening the trellis.

“In the erection of this kind of trellis, it is requisite to have an instrument for drawing the wires like the one represented at *fig. 151*. to the scale of an inch to a foot, which may be made without much difficulty. The one I have sketched was constructed by our own blacksmith, and is a very efficient contrivance for the purpose. After the stones are bored and set in their places, with the earth firmly rammed around them, the next thing to be done is to fix the main post *a*, and wedge it tight. It ought to lean about an inch back from the perpendicular, to allow for its giving a little when the whole strain of the wires comes upon it, which will bring it upright. The connecting bar (*c*) is then slipped down over it, while the lower end of the stay-bar (*b*) is put through the other eye and into the stone *e*, and the upper end screwed to the main post at *f*. The triangle from which the wires are to be stretched is then complete. A similar triangle must be made at the opposite end, and against the main post of which (*p*) the instrument above noticed is to be placed for the purpose of drawing the wire. This is done with great facility by means of a double piece of rope-yarn twisted several times round the end of each, and hooked, as shown at *h*. The screw *g* is then worked until the wire enters its proper hole in the post *p*, when it is bent and secured by a wedge, as already stated. The nuts on the bolts (*fig. 152.*) at the end from which the wires were drawn, are then screwed up a little, so as to make all the wires as tight as possible. The cost of the whole averages from 1s. 6d. to 2s. per yard.

“I have been thus minute with the details of the trellis and the mode of



erecting it, in order that those who approve of it may be able to have others erected on the same plan, for either of the purposes to which it has been successfully applied at Carclew. I am, Sir, your very obedient servant,

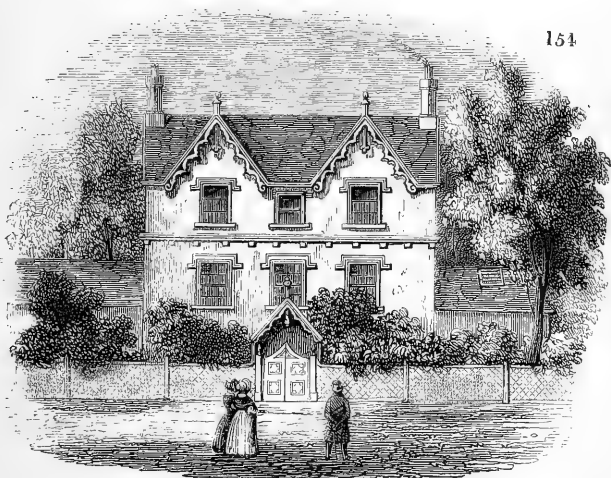
“WM. B. BOOTH.”

THE  
GARDENER'S MAGAZINE,  
DECEMBER, 1839.

---

ORIGINAL COMMUNICATIONS.

ART. I. *Descriptive Notices of select Suburban Residences, with Remarks on each ; intended to illustrate the Principles and Practice of Landscape-Gardening.* By the CONDUCTOR.



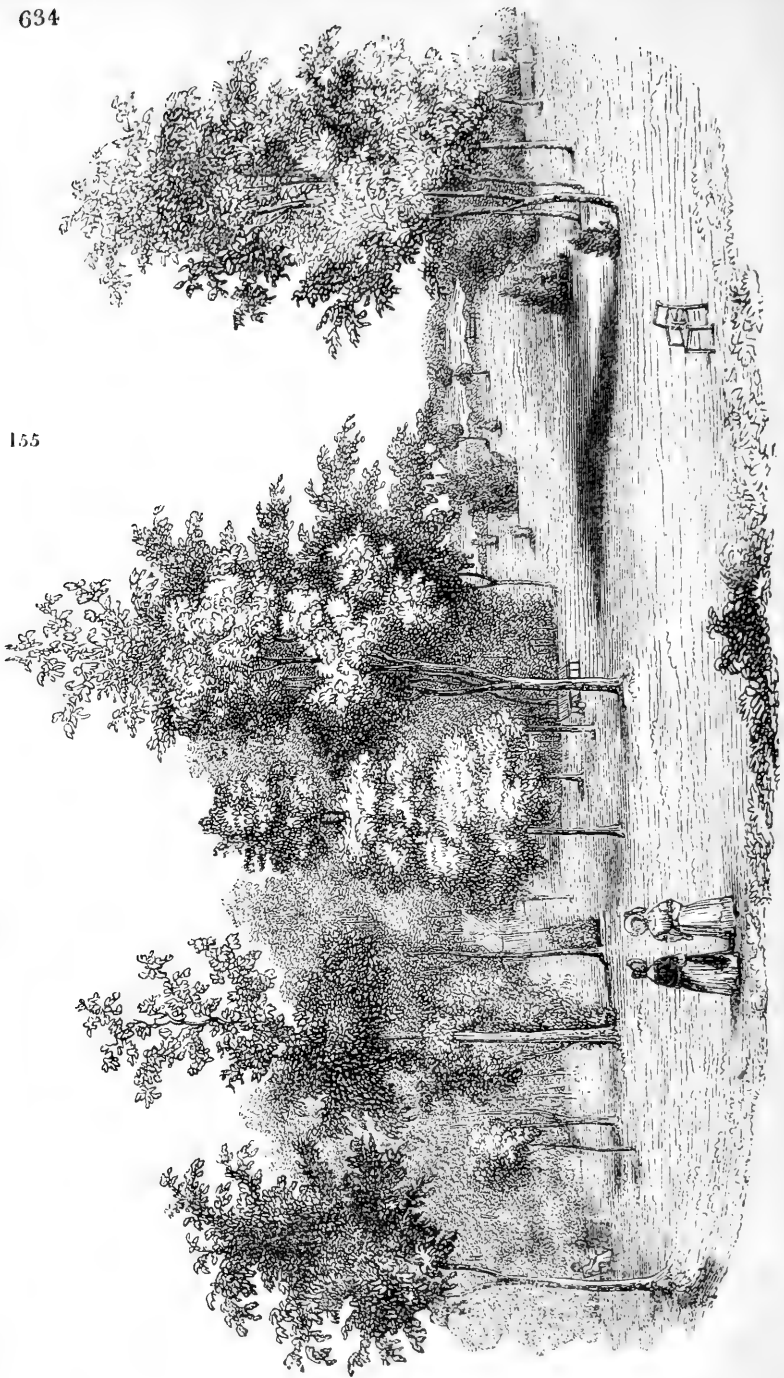
154

*Cheshunt Cottage, from the Road.*

NO. 13. CHESHUNT COTTAGE, THE RESIDENCE OF WM. HARRISON, ESQ.,  
F.L.S. G.S. A.S. Z.S., &c.

“All that can render a country seat delightful, and a well furnished library in the house.” (*Evelyn's Memoirs by Bray*, vol. i. p. 432.)

THE sides of the road from London to Cheshunt, by Stoke Newington, Edmonton, and Enfield Wash, are thickly studded with suburban houses and gardens the whole distance; but, by going straight on through the Ball's Pond turnpike, and taking the country road leading out of Newington Green, called the Green Lanes, between the Tottenham and Edmonton road and the Barnet road, and threading our way through numerous interesting lanes, we may pass through very rural and umbrageous



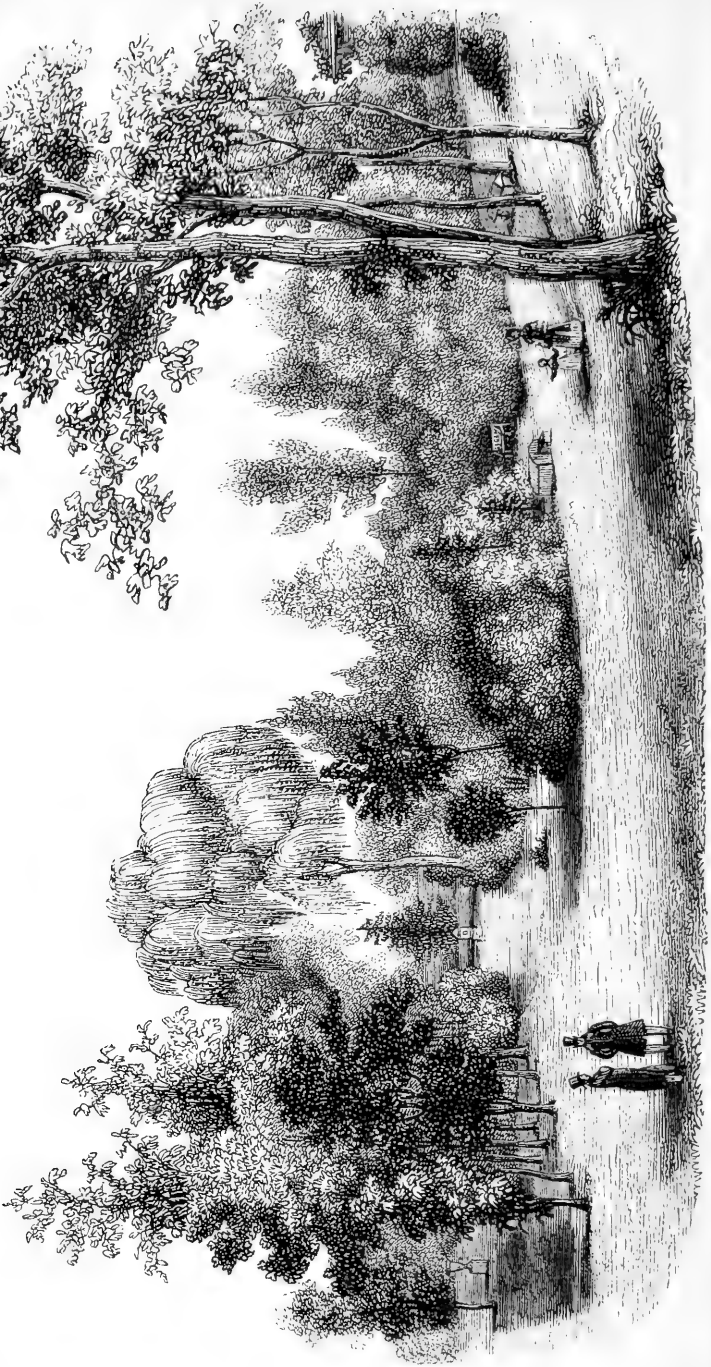
*View from the Drawingroom Window at Chesham Cottage, looking to the Left.*



scenery, with the appearance of but few houses of any kind. Indeed, it may be mentioned as one of the most remarkable circumstances in the state of the country in the neighbourhood of London, that, while all the main roads are bordered by houses for some miles from town, so as almost to resemble streets, there are tracts which lie between the main roads, and quite near town, which have undergone little or no change in the nature of their occupation for several, and apparently many, generations; at all events, not since the days of Queen Elizabeth. The tracts of country to which we allude are in pasture or meadow, with crooked irregular hedges, numerous stiles and footpaths, and occasional houses by the road sides; the farms characterised by large hay-barns. Scenery of this kind is never seen by the citizen who goes to his country seat along the public road, in his family carriage or in a stage-coach; and it is accordingly only known to pedestrians, and such as are not afraid of driving their horses over rough roads, or meeting waggons or hay carts in narrow lanes. The road through the Green Lanes to Enfield is an excellent turnpike road, always in a good state, with occasional villas near Bour Farm and Palmer's Green; and near Enfield, at Forty Hill, there is a handsome church, built and endowed by Mr. Myers, opposite to his park which is filled with large and handsome trees. Afterwards it passes the celebrated park of Theobalds, near where formerly stood a royal palace, the favourite residence of James I., and winds in the most agreeable and picturesque manner under the shade of overhanging trees. Having made several turns, it leads to a lane with a brook which runs parallel to the road, a foot-bridge across which forms the entrance to Mr. Harrison's cottage, as exhibited in the view *fig.* 154.

The ground occupied by Mr. Harrison's cottage and gardens is about seven acres, exclusive of two adjoining grass fields. The grounds lie entirely on one side of the house, as shown in the plan, *fig.* 165. in p. 656, 657. The surface of the whole is flat, and nothing is seen in the horizon in any direction but distant trees. The beauties of the place, to a stranger at his first glance, appear of the quiet and melancholy kind, as shown in the *figs.* 155, 156.; the one looking to the right from the drawingroom window, and the other to the left: but, upon a nearer examination by a person conversant with the subjects of botany and gardening, and knowing in what rural comfort consists, these views will be found to be full of intense interest, and to afford many instructive hints to the possessors of suburban villas or cottages.

In building the house and laying out the grounds, Mr. Harrison was his own architect and landscape-gardener; not only devising the general design, but furnishing working-drawings of all the details of the interior of the cottage. His reason for fixing on the present situation for the house was, the vicinity

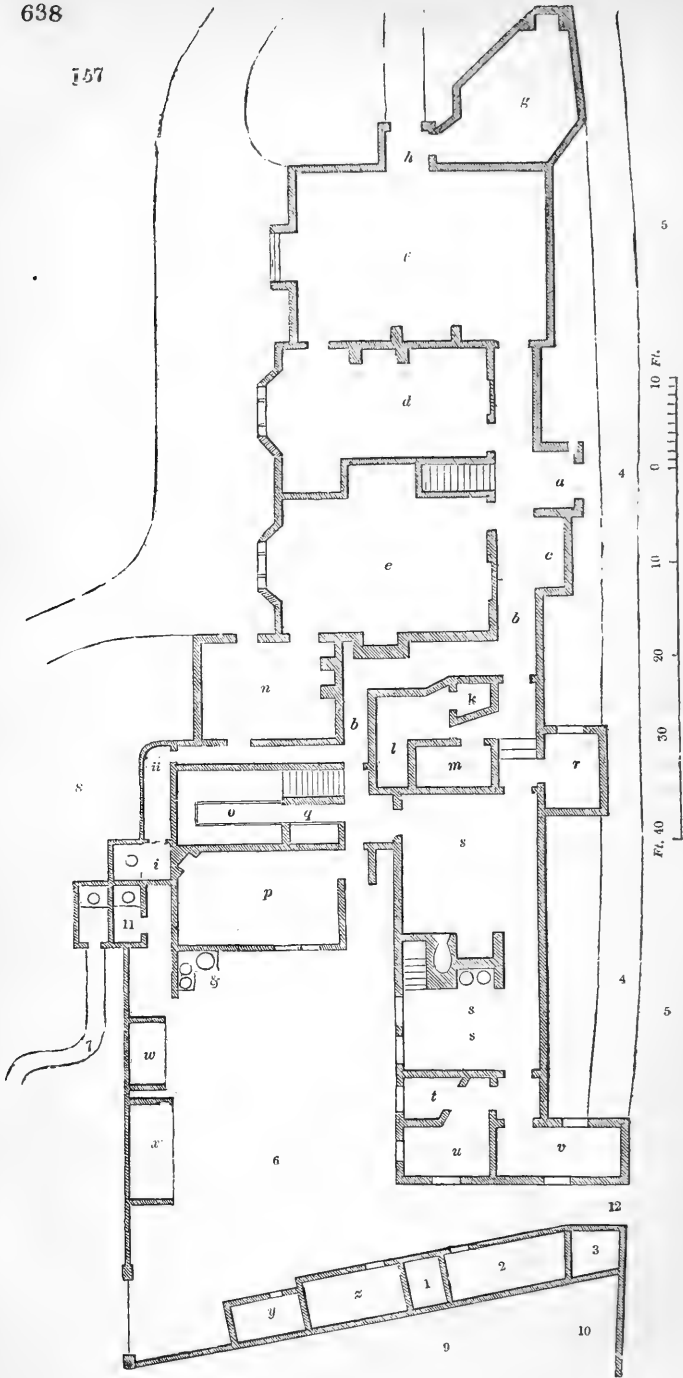


*View from the Drawingroom Window at Chesnut Cottage, looking to the Right.*

(the grounds joining) of a house and walk belonging to a relation of his late wife. This circumstance is mentioned as accounting in one so fond of a garden, for fixing on a spot which had neither tree nor shrub in it when he first inhabited it. Mr. Harrison informs us, and we record it for the use of amateurs commencing, or extending, or improving gardens, that he commenced his operations about thirty years ago, by purchasing, at a large nursery sale, large lots of evergreens, not 6 in. high, in beds of one hundred each, such as laurels, Portugal laurels, laurustinuses, bays, hollies, &c.; with many lots of deciduous trees, in smaller numbers, which he planted in a nursery on his own ground; and at intervals, as he from time to time extended his garden, he took out every second plant, which, with occasional particular trees and shrubs from nursery grounds, constituted a continual supply for improvement and extension. This, with the hospital ground mentioned hereafter, furnished the means of extensions and improvements at no other expense than labour, which, when completed, gave the place the appearance of an old garden; the plants being larger than could be obtained, or, if obtained, safely transplanted, from nurseries. This is an important consideration, in addition to that of economy, well worth the attention of amateur improvers of grounds or gardens.

By inspecting the plan *fig.* 157., it will be found that the house contains, on the ground floor, three good living-rooms, and two other rooms (*n* and *g*) particularly appropriate to the residence of an amateur fond of botany and gardening; and that it is replete with every description of accommodation and convenience requisite for the enjoyment of all the comforts and luxuries that a man of taste can desire for himself or his friends.

In laying out the grounds, the first object was to insure agricultural and gardening comforts; and hence the completeness of the farmyard, and of the hot-house and frame departments, as exhibited in the plan, *fig.* 159. On the side of the grounds opposite to the hot-houses and flower-garden are the kitchen-garden and orchard; and though in most situations it would have been more convenient to have had the farm buildings, the kitchen-garden, and the hot-houses on the same side as the kitchen offices, yet in this case no inconvenience results from their separation; because the public road, as will be seen by the plan *fig.* 165., forms a ready medium of communication between them, in cases in which the communication through the ornamented ground would be unsightly or inconvenient. In arranging the pleasure-ground, the great object, as in all similar cases, was to introduce as much variety as could be conveniently done in a comparatively limited space. This has been effected chiefly by distributing over the lawn a collection of trees and shrubs; by forming a small piece of water, and disposing of the earth



Ground Plan of Chestnut College.

excavated into hilly inequalities; and by walks leading to different points of view, indicated by different kinds of covered seats or garden structures. In conducting the walks, and distributing the trees and shrubs, considerable skill and taste have been displayed in concealing the distant walks, and those which cross the lawn in different directions, from the windows of the living-rooms; and also in never showing any walk but the one which is being walked on, to a spectator making the circuit of the grounds.

Before we enter into further details, we shall describe, first, the plan of the house; secondly, that of the farm and garden offices and the hot-houses; and, thirdly, the general plan of the grounds.

The house, in its external form and interior arrangement, is to be considered as a cottage, or rather as a villa assuming a cottage character. Hence, the centre part of the house, over the dining and drawing rooms, appears, from the elevation of the entrance front, to be only two stories high. There is, however, a concealed story over part of the offices, for servants' bedrooms.

The house, of which *fig.* 157. is an enlarged plan, consists of:  
*a*, The porch, entered from a bridge thrown across the brook, 4, as shown in *fig.* 154.

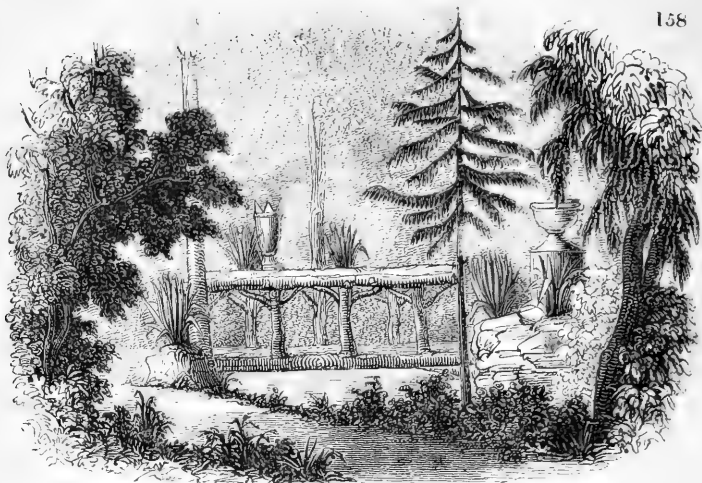
*b b*, Passage, from which are seen the stairs to the bedrooms; and in which, at *ii*, there is a jib-door and a ventilating window, to prevent the possibility of the smell from the kitchen or offices, or water-closet, penetrating to the other parts of the passage.

*c*, Recess for coats, hats, &c., fitted up with a hat and umbrella-stand, tables, &c.

*d*, Drawingroom, with a recess at the further end, fitted up with a sofa and a writing-table.

*e*, Dining-room, with a recess for the largest sideboard, and another for a smaller sideboard and cellarets.

*f*, Library, chiefly lighted from the roof, but having one window to the garden, and a glass door to the porch *h*, also looking into the garden, and from which the view *fig.* 158. is obtained. This room is fitted up with bookcases all round; those on each side of the fire-place being over large cabinets, about 4 ft. 6 in. high, filled with a collection of shells, minerals, and organic remains, &c.; and, to save the space that would otherwise be lost at the angles, pentagonal closets are formed there, in which maps, and various articles that cannot be conveniently put on the regular bookshelves, are kept. The doors to these corner closets are not more than 9 in. in width, and they are of paneled wainscot. The shelves are fitted in front with mahogany double reeds, fixing the cloth which protects the tops of the books, thus giving the appearance of mahogany.



View from the Library Porch.

- g*, Museum for specimens of minerals and other curiosities, entered from the porch *h*, and lighted from that porch, and from a window in the roof.
- h*, Porch leading to the garden, from the library and museum.
- i*, Ladies' water-closet, kept warm by the heat from the back of the servants' hall fire; the back of the fireplace being a cast-iron plate.      *ii*, Jib-door.      *k*, Plate-closet.
- l*, Butler's pantry, lighted from the roof.
- m*, China-closet, lighted from the roof.
- n*, Room serving as a passage between the dining-room and the garden, and also between the dining-room and the water-closet *i*, containing a turning-lathe, a carpenter's work-bench, a complete set of carpenter's tools, garden tools for pruning, &c., of all sorts; spuds with handles, graduated with feet and inches, fishing tackle, archery articles, &c.
- o*, Inner wine-cellar, where the principal stock of wine is kept. There is a ventilating opening from this cellar into the passage *b*.      *p*, Servants' hall.
- q*, Outer wine-cellar, where the wine given out weekly for use is placed, and entered in the butler's book. Between *q* and the passage *b* are seen the stairs leading to the servants' bedrooms.      *r*, Beer-cellar.
- s*, Kitchen, lighted from the roof, and from a window on one side.
- ss*, Scullery, lighted from one side.      *t*, Housekeeper's closet.
- u*, Coal-cellar.      *v*, Larder.      *w*, Bottle rack.
- x*, Safe for cold meat.      *y*, Wash-house.      *z*, Knife-house.
- z*, Filtering apparatus.      1, Ash-pit.      2, Coal-house.

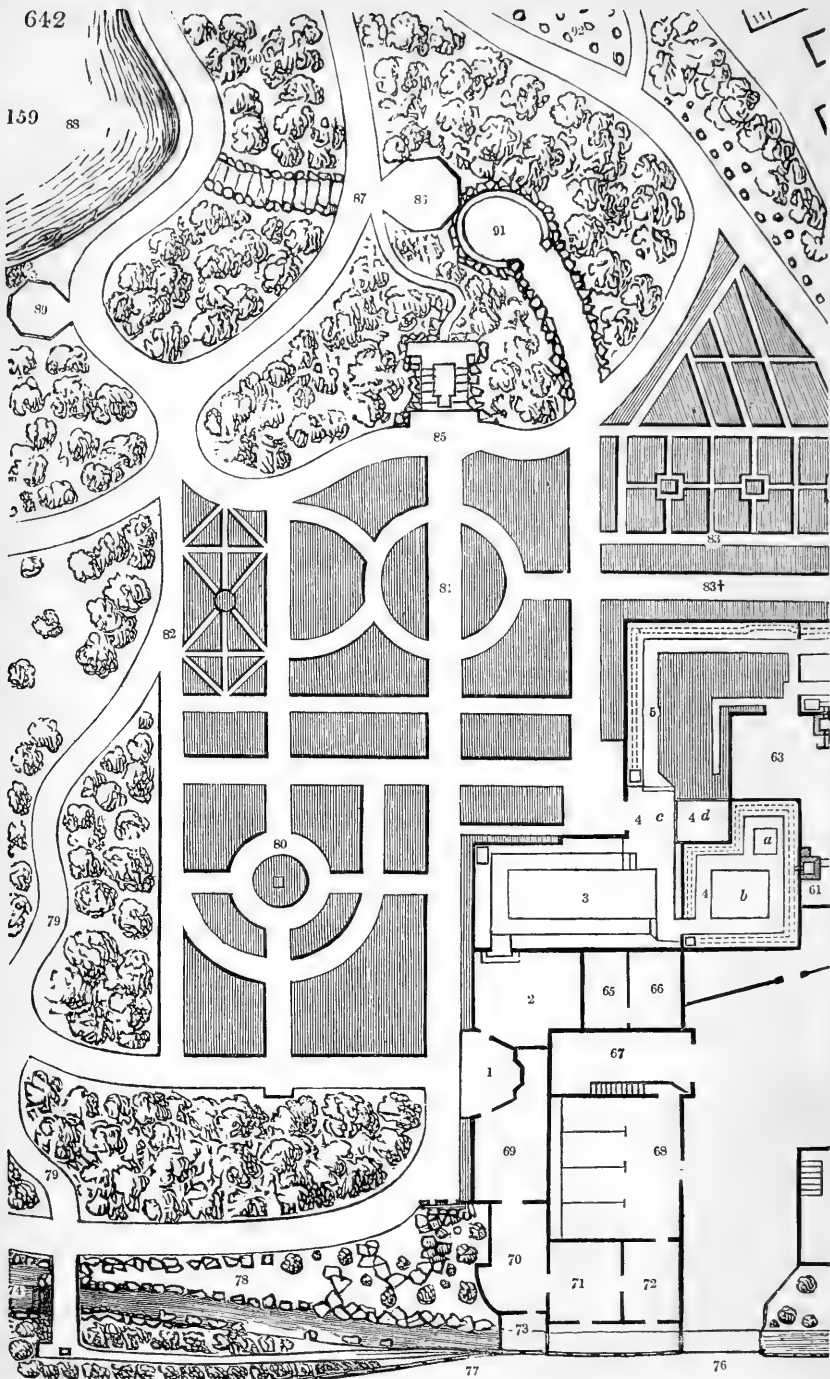
- 3, Fireplace to the vinery at 10, in the kitchen-garden 9.  
 4 4, Brook.                    5 5, Public road.                    6, Kitchen-court.  
 7, Concealed path to gentlemen's water-closet.  
 8, Plantation of evergreens.                    9, Kitchen-garden.  
 10, Vinery.                    11, House servants' water-closet.  
 12, Servants' entrance.

Though it cannot be said that the arrangement of the offices of this house is so good as it would be, if they were placed on each side of a straight passage; yet it will not be denied, that these offices include every thing that is desirable for comfort and even luxury. The chief difficulty which occurs to a stranger, in looking at the plan, is, to discover how several of the rooms which compose the offices are lighted; and this, it may be necessary to state, is chiefly effected from the roof; a mode which, in the case of some rooms, such as a butler's pantry, china-closet, plate-room, &c., is to be preferred; but which in most cases it is desirable to avoid.

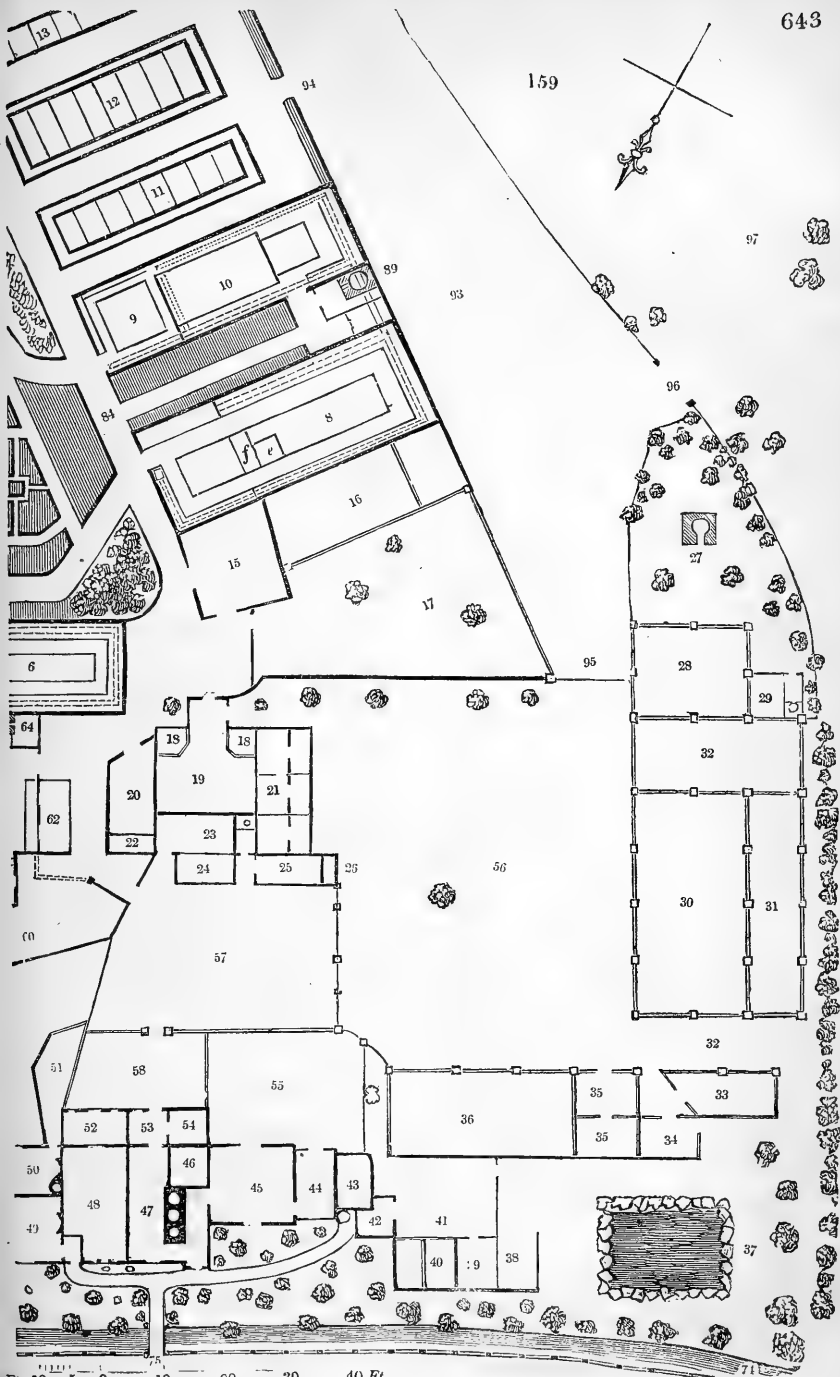
The three windows to the three principal rooms being on the same side of the house, and adjoining each other, must necessarily have a sameness of view; but the quiet character intended to be produced by the idea of a cottage by a road side, may be supposed to account for circumstances of this kind, and for various others.

The following are the details of the farmyard, garden offices, and hot-houses, as exhibited in *fig. 159.* : —

- 1, Rustic alcove, forming a recess under a thatched roof, which covers the space from the green-house, 3, to the houses or yards, 70, 71, and 72. This rustic alcove has the floor paved with small pebbles, and the sides and ceiling lined with young fir-wood, with the bark on. There is a disguised door on the right, which leads to 69, a house for grinding-mills and other machines; and on the left, which leads to 2, the ship-room. In the upper part of the central compartment, in a square recess fronting the entrance, is a white marble statue of the Indian god Gaudama, or Gaudmia. Three Elizabethan benches, each as long as one of the sides of the alcove, are placed so as to disguise the doors. The external appearance of this alcove is shown in *fig. 160.*
- 2, Ship-room, paved with slate, and with the walls finished in stucco, and ceiling with beams painted like oak, to which are hung Indian spears, and other curiosities, and serving to contain models of ships and vessels of various sorts during winter. These are placed on the pond in the summer season; square-rigged vessels at fixed anchorage, and the fore-and-aft-rigged ones, whose sails traverse, such as schooners, cutters, and coasting vessels, with cables of lengths to allow of their sailing without touching the edges of the pond; and these







Fl. 10 5 0 10 20 30 40 Fl.



Rustic Alcove.

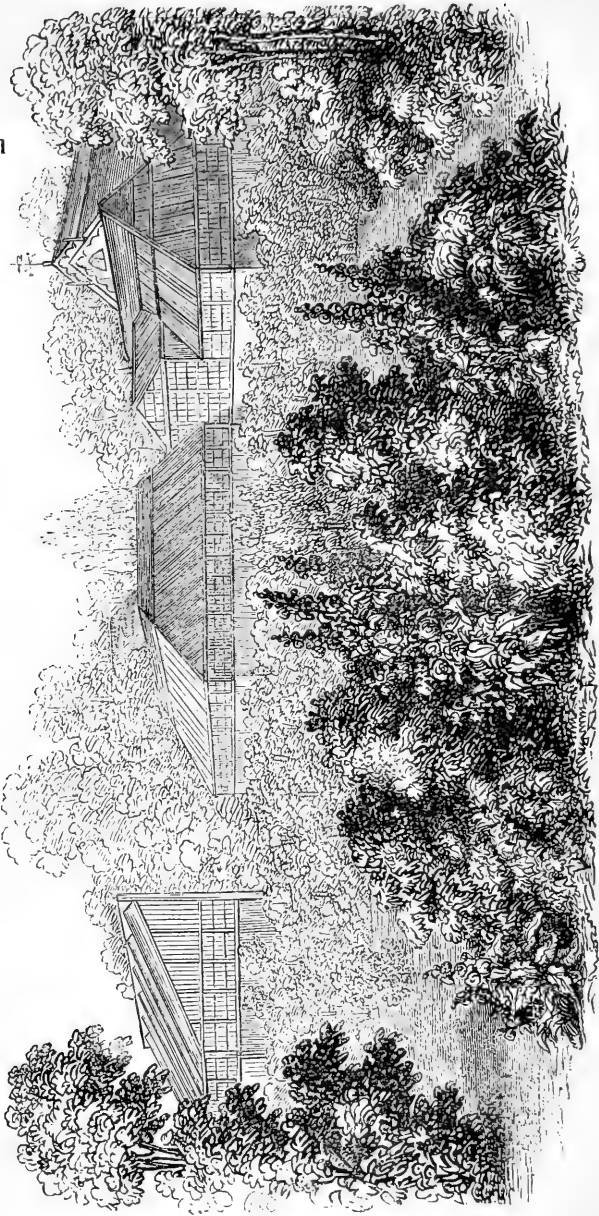
continue constantly traversing the pond when there is any wind. This room also contains a variety of the warlike instruments of the savages of different countries, a bust of Lord Nelson, one of the Duke of Wellington, some pictures in mosaic, and a number of East Indian curiosities. It serves, also, as a lobby to the orangery.

- 3, The orangery. The paths are of slate, and the centre bed, or pit, for the orange trees is covered with an open wooden grating, on which are placed the smaller pots; while the larger ones, and the boxes and tubs, are let down through openings made in the grating, as deep as it may be necessary for the proper effect of the heads of the trees. This house, and that for *Orchidææ*, are heated from the boiler indicated at 61.
- 4, Orchidaceous and fern house, in which *a* is the stage for *Orchidææ*, and *b* a cone of rockwork, chiefly of vitrified bricks, for ferns. These ferns, amounting to above two dozen species, all sprang up accidentally from the soil attached to some plants which were sent to Mr. Harrison from Rio Janeiro and other parts of South America. The shelves round the house are also occupied with *Orchidææ*, all of which are in pots, in order that, when they come into flower, they may be removed to the green-house; as, when thus treated, as practised by the Duke of Devonshire at Chatsworth, they continue much longer in bloom, than when kept in the degree of heat necessary for their growth.
- 4 *c*, Lobby between the orangery (3) and the conservatory (5).
- 4 *d*, An aviary for canaries, separated from the conservatory and the lobby by a wire grating, and from the orchidaceous house by a wall. Both the aviary and the lobby have a glass

roof in the same plane as that of the conservatory, as may be seen in *fig.* 161. in p. 646. In the winter season, the temperature of the aviary being the same as that of the conservatory, the birds require little or no care, except giving them food; while they sing freely at that season, and greatly enliven this part of the garden scenery.

- 5, Conservatory, with vines under the rafters. The walks are of slate, the shrubs are planted in a bed of free soil edged with slate, and the back wall is covered with different species of *Passiflora*, and with the *Tacsònia pinnatistípula*.
- 6, Camellia-house. The camellias kept in pots; the rafters covered with vines, and the back wall with passifloras and other climbers. This house, and also 5, are heated from one boiler, as indicated at 64.
- 7, Geranium-house. The roof is in the ridge and furrow manner of Mr. Paxton. This house, and also 8, 9, and 10, are heated from the boiler indicated at 89.
- 8, Botanic stove. The roof is in the ridge and furrow manner of Paxton, as shown in *figs.* 169, 170, 171. in p. 661. and 662. The sides of the pit are formed of slabs of slate; and there is a slate box at *e*, containing a plant of *Musa Cavendishii* with a spike of fruit, two or three of which ripen off weekly. *f* is a cistern for stove aquatics. There is a plant of *Brugmánsia suavèolens* (*Datura arborea L.*) 15 ft. high, with a head 13 ft. in diameter. When we saw it, August 10th, 277 blossoms were expanded at once, producing an effect upon the spectator under the tree, when looking up, which no language can describe. Last year it produced successions of blossoms, in one of which 600 were fully expanded at one time. This year it has had five successions of blossoms, and another is now coming out as the plant expands in growth. There is a large *Brugmánsia coccínea* in this house. Both these plants are in the free soil.
- 9, House for Cape heaths.
- 10, Pinery. The roof of this house is in the ridge and furrow manner, in imitation of Mr. Paxton's mode; from which it differs, in having the ridge about one third higher in proportion to the breadth, in having the sash-bar deeper, and placed at right angles to the crown of the ridge and to the furrow, and in having the panes of twice the size which they are in Mr. Paxton's roof. This house was built by Mr. Harrison's carpenter, from the general idea given to him; and before he had been to Chatsworth to examine the original house with this kind of roof, built there by Mr. Paxton.
- 11, Cucumber-pit, on M'Phail's plan.
- 12, Succession pine-pit, also on M'Phail's plan, in order to be heated with dung linings.

161



*General View of the Ilo-houses, as seen across the American Garden.*

13, Melon-pit.

14, Dutch cold-pit, for preserving lettuces, cauliflowers, &c., during winter.

15, Tool-house and potting-shed; the tools regularly hung on irons fixed to the ceiling, or set against the wall, or laid on shelves, the place for each sort of tool or implement, ropes, &c., being painted in large white letters on black boards. The following rules are painted on a board which is hung up in the tool-house: —

*“ Rules to be observed by all Persons working on these Premises, Masters and Men.*

“ I. For every tool or implement of any description not returned to the usual place at night, or returned to a wrong place not appointed for it, or returned or hung up in a dirty or unfit state for work, the forfeit is 3*d.*

“ II. For every heap of sweepings or rakings left at night uncleared, forfeit 3*d.*

“ III. Every person making use of bad language to any person on these premises shall forfeit, for each and every such offence, 6*d.*

“ IV. Every person found drunk on these premises shall forfeit one shilling; and, if he be in regular employment on the premises, he shall be suspended from his employment one day for every hour he loses through drunkenness.

“ V. Every person who shall knowingly conceal or screen any person offending shall be fined double the amount of the fine for the offence he so conceals, in addition to the fine of the offending party.

“ VI. All forfeits to be paid to the gardener, on or before the Saturday night following. If any person working regularly on the premises fail to conform to the above rules and regulations, the gardener shall be at liberty to stop his fines from his wages. Further, should any foreman or journeyman fail to comply with the above rules and regulations (with a knowledge of them), the gardener shall be at liberty to seize and sell his tools or part of them, to pay such fines, in one month from the time the offence was committed.

“ VII. All fines to be expended in a supper, yearly, to all the parties who have been fined.”

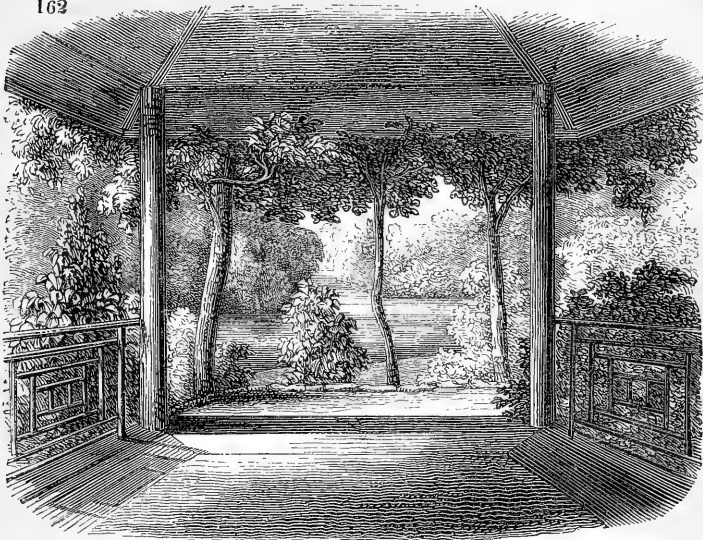
When these rules were first adopted, the fines were sufficient to afford an annual supper, with beer, &c.; but of late the amount has been so small, that Mr. Harrison has found it necessary to add to it to supply beer, &c., for the supper; a proof of the excellent working of the rules. Mr. Harrison remarks that these rules were established about eleven years ago, and that they have been most effective in preventing all slovenly practices; an advantage which he considers as thus purchased at a very cheap rate.

- 16, Mushroom-shed, in which the mushrooms are grown in Oldacre's manner.
- 17, Wood-yard, shaded by three elm trees.
- 18 18, Calf-pens.                      19, Cow-house.                      20, Tool-house.
- 21, Piggeries.
- 22, 23, 24, Places for fattening poultry, on Mowbray's plan, not, as usual, in coops. Between this and 25 is a privy for the head gardener.
- 25, Place for meat for the pigs, which is passed through a shoot to 26.
- 26, Two tanks sunk in the ground, covered with hinged flaps, the upper edges of which lap under the plate above, so as to shoot off the rain, for souring the food intended for the pigs. One tank, which is much smaller than the other, is used chiefly for milk and meal for the fattening pigs, and sows with pigs; and the other for the wash and other refuse from the house, for the store pigs, which, with the refuse from the garden, apple-loft, &c., amply supplies the store pigs and sows, without any purchased food, except when they have pigs sucking. The good effect of the fermentation or souring is accounted for by chemists, who have found that it ruptures the ultimate particles of the meal or other food; a subject treated in detail in the *Quarterly Journal of Agriculture*, vol. vii. p. 445. According to the doctrine there laid down, the globules of meal, or farinaceous matter of the roots and seeds of plants, lie closely compacted together, within membranes so exquisitely thin and transparent, that their texture is scarcely to be discerned with the most powerful microscope. Each farinaceous particle is, therefore, considered as enveloped in a vesicle, which it is necessary to burst, in order to allow the soluble or nutritious part to escape. This bursting is effected by boiling, or other modes of cookery; and also, to a certain extent, by the stomach, when too much food is not taken at a time: but it is also effected by the heat and decomposition produced by fermentation; and, hence, fermented food, like food which has been cooked, is more easily digested than uncooked or unfermented food. Plants are nourished by the ultimate particles of manure, in the same way that animals are nourished by the ultimate particles of food; and hence fermentation is as essential to the dunghill as cookery is to food. The young gardener, as well as the young farmer, may learn from this the vast importance of fermentation, in preparing the food both for plants and animals.
- 27, Furnace and boiler, for boiling dogs' meat, heating pitch, &c.; placed in this distant and concealed spot to prevent risk from fire when pitch or tar is boiled; and, when meat is boiled for dogs, to prevent the smell from reaching the garden.

- The reason why it is found necessary to have a boiler for tar is, that, most of the farm-buildings and garden-offices being of wood, it is found conducive to their preservation occasionally to coat them with tar heated to its boiling point.
- 28, Open shed for lumber.
- 29, Dog-kennel; adjoining which is a privy for the under gardeners.
- 30, Hay-barn.                      31, Lean-to for straw.
- 32 32, Places for loaded hay-carts to unload, or to remain in when loaded during the night, in order to be ready to cart to town or to market early in the morning.
- 33, House for lumber, wood, &c.                      34, Duck-house.
- 35 35, Houses for geese and turkeys.
- 36, Open shed for carts and farm implements.
- 37, Pond, surrounded by rockwork and quince trees.
- 38, House for a spring-cart.                      39, Coal-house for Mr. Pratt.
- 40 40, Places for young chickens.
- 41, Yard to chicken-houses.
- 42, Hatching-house for hens, containing boxes, each 1 ft. square within, with an opening in front 7 in. wide and 7 in. high, the top being arched, so that the sides of the opening are only 5 in. high.
- 43, Lobby to Mr. Pratt's house.                      44, His kitchen.
- 45, Living-room.
- 46, Oven, opening to 47.
- 47, Brewhouse, bakehouse, and scullery, containing a copper for brewing, another for the dairy utensils, and a third for washing, besides the oven already mentioned.
- 48, Dairy. The milk dishes are of white earthenware; zinc having been tried, but having been found not to throw up the cream so speedily and effectively as had been promised. One zinc dish, with handles, is used for clotted cream, which is regularly made during the whole of the fruit season, and occasionally for dinner parties, for preserved tarts, &c. We observed here small tin cases for sending eggs and butter to town. The butter, wrapped in leaves, or a butter cloth, is placed in the bottom of a tin box about a foot square, so as to fill the box completely; and another tin box is placed over it, the inner box resting on a rebate, to prevent its crushing the butter below it. In this latter box, the eggs are packed in bran, after which the cover of the outer one is put on, and the whole may then be sent to any distance by coach. The dairy is supplied with water from a pump in the scullery; the water being conveniently distributed in both places by open tubes and pipes.
- 49, Coachman's living-room.
- 50, Coachman's kitchen, and stairs to two bedrooms over.

- 51, Court for enclosing the coachman's children.
- 52, Lobby to the dairy. 53, Lobby to Mr. Pratt's brewhouse.
- 54, Cellar. 55, Chicken-yard.
- 56, Farmer's yard.
- 57, A gravelled court separating the coach-yard, 59, from the stable-yard, 56.
- 58, Place for slaughtering in. 59, Stable-yard.
- 60, Shed for compost, and various other garden materials; such as a tub for liquid manure, in which it ferments and forms a scum on the top, while the liquid is drawn off below by a faucet with a screw spigot, such as is common in Derbyshire and other parts of the north, which admits the water to come out through the under side of the faucet. Here are also kept paint pots, oil cans, boxes, baskets, and a variety of other matters. The whole of this shed is kept warm by the heat which escapes from the fireplace in 61, and from the back of the orchidaceous house, 4.
- 61, Fireplace and boiler for heating the orchidaceous house.
- 62, Place for arranging garden pots.
- 63, Shed, with roof of patent slates, which becomes a cheap mode of roofing in consequence of requiring so few rafters, amply lighted from the roof, and kept warm in the winter time by the heat proceeding from the boilers at 61 and 64. This shed contains a potting-bench, cistern of water, and compartments for mould; and, being lofty, it contains in the upper part two apartments enclosed by wirework, for curious foreign pigeons or other birds. On the ground are set, during the winter season, the large agaves and other succulent plants which are then in a dormant state, and which are kept in the open garden during summer. On the whole, this is an exceedingly convenient working-shed; being central to the houses 3, 4, 5, and 6; being kept comfortably warm by the boilers; being well lighted from the roof; and having the two windows indicated at 62, before which is the potting-bench.
- 64, Fireplace to the conservatory and the camellia-house.
- 65, Place for keeping food for the rabbits and pigeons, with stairs to the pigeon-house, which is placed over it.
- 66, Rabbit-house, containing twenty-one hutches, each of which is a cubic box of 20 in. on the side. Each box is in two divisions, an eating-place and a sleeping-place; the sleeping-place is 8 in. wide, and is entered by an opening in the back part of the partition. Both divisions have an outer door in front; and, in order that the door of the sleeping-place may not be opened by any stranger, it is fastened by an iron pin, which cannot be seen or touched till the door of the eating-place is opened. Mr. Pratt pointed this out to us as an improvement in the construction of rabbit-hutches, well deserving of imita-





View from the Chinese Temple.

tion wherever there is any chance of boys or idle persons getting into the rabbit-house. The rabbits are fed on garden vegetables and bran, barley, oatmeal, and hay, making frequent changes; the vegetables being gathered three or four days before being used, and laid in a heap to sweat, in order to deprive them of a portion of their moisture. Salt is also given occasionally with the bran. Cleanliness, and frequent change of food, have now, for five years, kept the rabbits in constant health. It ought never to be forgotten, that attention to the above rules, in partially drying green succulent vegetables, is essential to the thriving of rabbits kept in hutches; and, hence, in London and other large towns, instead of fresh vegetables, they are fed with clover-hay. One of the kinds of rabbit bred at Mr. Harrison's is the hare rabbit, mentioned in the *Encyclopædia of Agriculture*, § 7355., the flesh of which resembles that of the hare, in quantity and flavour. Mr. Pratt has fed rabbits here, which, when killed, weighed 11 lbs. We can testify to their excellence when cooked.

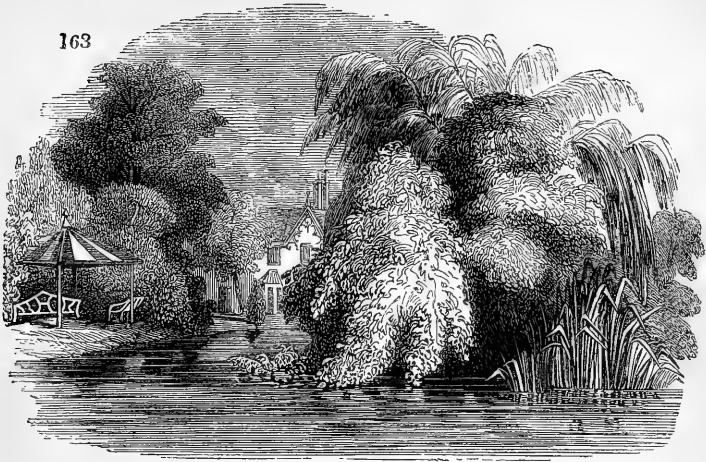
67, Coach-house, with stairs to hay-loft.

68, Stable.

69, Mill-house, containing mills for bruising corn for poultry, a portable flour mill, a lathe, and grinding-machine for sharpening garden instruments and similar articles. In the Angel Inn in Oxford, some years ago, a lathe of this sort was used for cleaning shoes, the brushes being fixed to the circum-

- ference of the wheel, and the shoes applied to them, while the wheel was turned round by a tread lever, or treadle.
- 70, Root-house, containing bins for keeping different kinds of potatoes, carrots, parsneps, Jerusalem artichokes, beets, and yellow, French, and white turnips, with shelves for onions; and a loft over, which is used as a fruit-room. The fruit is kept partly on shelves, and partly on cupboard trays.
- 71, Store place for beer or ale, which is brewed by Mr. Pratt for the use of the family in London, as well as at Cheshunt; here is also a regular staircase to the fruit-room.
- 72, Harness-room, properly fitted up with every convenience, and warmed by a stove.
- 73, A lobby or court to a door which opens to the brook, for the purpose of clearing out an excavation made in the bottom of the channel, in order to intercept mud, and thus render the water quite clear where it passes along the pleasure-ground, and is seen from the library window and the grand walk. (*fig.* 158. in p. 640.) The whole of any mud which may collect in the brook may be wheeled up a plank through this door, without dirtying the walk.
- 74 74, The brook.
- 75, Foot entrance to Mr. Pratt's house, the coachman's house, the dairy, &c.
- 76, Carriage entrance to the stable-court, garden offices, farm-yard, &c.
- 77, Private entrance to the garden, over the rustic bridge shown in *fig.* 158.
- 78, Masses of vitrified bricks and blocks of stone, distributed among lawn and shrubs; among which, large plants of agave, and other rock exotics, are placed in the summer season. The pots and tubs being concealed, by covering them with the stones forming the masses of rockwork. Here the semicircular space surrounded by rock contains a collection of Himalayan rhododendrons, &c., in pots, many of them seedlings which have not yet flowered.
- 79 79, American shrubbery, consisting chiefly of rhododendrons, azaleas, magnolias, &c., growing in peat earth kept moist by the brook.
- 80, American garden, consisting of choice American shrubs, and American herbaceous plants. In the centre of the circle a handsome tazza vase on a bold pedestal.
- 81, Two semicircles for dahlias; the surrounding compartments containing a collection of roses.
- 82, Garden of florist's flowers.
- 83 83, Garden of herbaceous plants, chiefly annuals. The walks in all these gardens are edged with slate. The bed 83† contains a collection of choice standard roses. 84, Dahlias.

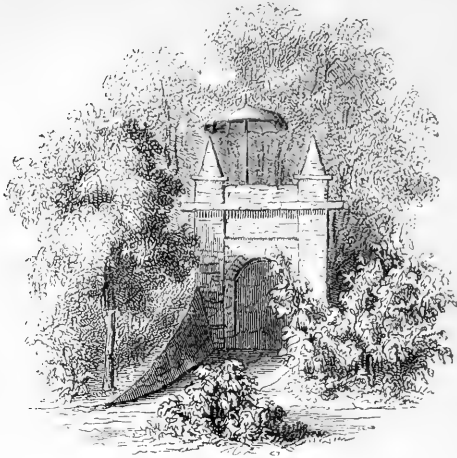
163



*Distant View of the House and Tent, across the Pond.*

- 85, Double ascent of steps to a mound formed of the earth removed in excavating for the pond. From the platform to which these steps lead, there is a circuitous path to the Chinese temple; and the steps are ornamented with Chinese vases, thus affording a note of preparation for the Chinese temple. The outer sides of the steps are formed of rockwork, and between the two stairs is a pedestal with Chinese ornaments.
- 86, The Chinese temple, on the highest part of the mound formed of the soil taken from the excavation now constituting the pond. The view from the interior of this temple is shown in *fig.* 162. p. 651.
- 87, Rustic steps descending from the Chinese temple to the walk which borders the pond.      88, The pond.
- 89, Open tent, with sheet-iron roof supported by iron rods. This structure may be seen in the view *fig.* 163.
- 90 90, Masses of evergreens and deciduous trees and shrubs.
- 91, Grotto, made late last year, not yet completed. It was formerly an outer ice-house, but it failed as such. The entrance is surrounded by rockwork, and the interior in the form of a horseshoe, furnished with a wooden bench as a seat. Over this grotto is an umbrella tent, as shown in the view *fig.* 164. in p. 654.      92, Dahlias.
- 93, Slip of ground for compost, and various other materials requisite for the garden and farmyard; communicating with the frame-ground by the door 94, with the farmyard by the gate 95, and with the farm by the gate 96.
- 94, Door from the frame-ground to the slip behind.
- 95, Gate from the slip to the farmyard.
- 96, A gate from the slip to the fields of the farm.

164



Grotto, with Umbrella Tent over.

97, Grass field, forming part of the farm.

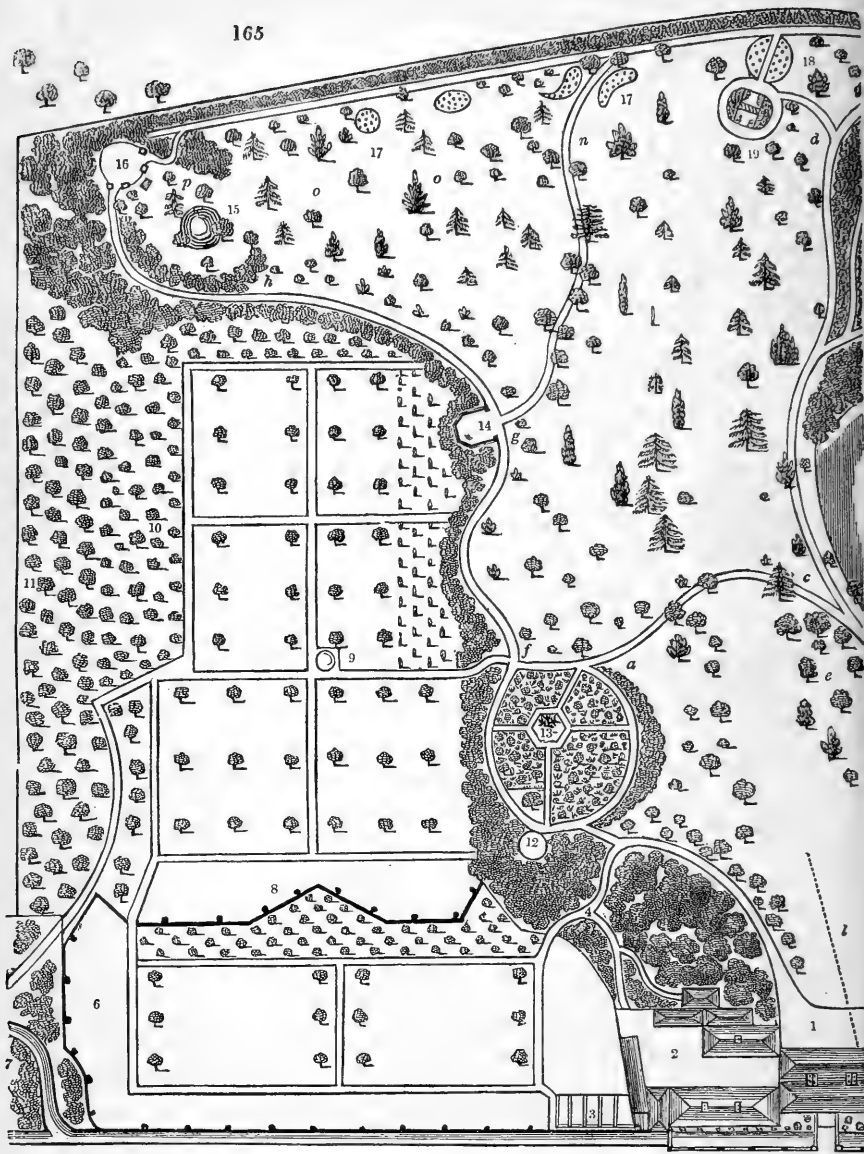
*Fig. 165.* in p. 656, 657., is a vertical profile of the gardens and pleasure-ground, with the farmyard, and a small portion of the farm. This view shows :—

- 1, The house.
- 2, The domestic offices and yard.
- 3, Vinery in small garden.
- 4, Back entrance to the domestic offices, and the smaller kitchen-garden. On one side of this walk is placed one of Fuller's portable ice-boxes.

*Fuller's Ice-Box.*— This box is one of the most ingenious and useful inventions that have been introduced into the domestic economy of the wealthy classes for many years. It may be described as one box within another, the inner box being 6 inches apart from the outer box on every side, and at the top and bottom. The space between the outer box and the inner box is filled up with burnt cork in a state of powder, as being a better nonconductor of heat than powdered charcoal of common wood. The lid is double like the sides, and the vacuity filled with charcoal in the same manner, to prevent the possibility of air getting in to the contents of the box when it is shut. The lid has ledges which project downwards into a gutter containing water, so as to render the junction airtight. The ice is contained in the well or space thus enclosed and protected, which is lined with cork; and which will keep the rough ice for three, four, and five weeks, in the hottest weather of summer. Mr. Harrison's box is 3 ft. 5 in. by 2 ft. 8 in., and 3 ft. 5 in. in depth, outside measure; and the well, or inner box, will contain 300 lbs. of rough ice. The cost of a box of this size complete is 25*l.* 4*s.* The cost of the ice which is required to fill it, and which is

supplied by a large wholesale dealer in that article at Southgate, Mr. Symonds, is about 15s.; the price per cwt. varying from 4s. to 6s., of three sorts, sweepings, mixed, and pure, at different prices. The box three times filled will serve an ordinary family a whole season. When we consider the expense of building an ice-house; the uncertainty of its answering the end proposed; the expense of filling it annually with ice, and of taking out a portion every two or three days, or in the hottest weather every day; the saving by the use of the ice-preserver must be obvious. In fact, there are few families who have an ice-house, who would not save a considerable sum every year by it, and be much more certain of always having ice when they wanted it. The box is the invention of Mr. Fuller, No. 60. Jermyn Street, London; and, when it once becomes properly known, we have no doubt that it, or some similar contrivance, will take the place of ice-houses in suburban residences all over the country. As this takes place, a demand will be created for dealers in ice, who will collect and preserve it better, and at far less expense, than any individual can do, and who will supply the possessors of boxes. The mere circumstance of an immense body of ice being put together will contribute to its preservation, while the smaller quantities put into private ice-houses, and often most improperly mixed with salt while being put in, is always liable to melt, by the penetration of the heat with which it is surrounded. Though the invention has been only a very short time before the public, we already know some gentlemen having ice-houses near town who have given up filling them, and who, having procured a box, get it filled two or three times in the course of the summer, at an expense, for the season, of not more than 2*l.* or 3*l.* In the very complete offices at Elvaston Castle, the seat of the Earl of Harrington, near Derby, the ice-house may be said to form a part of the castle, being, as already observed in p. 460., under a tower which forms the larder. In a vaulted room near the butler's pantry, there are two cold closets or presses formed by Mr. Fuller. They consist of double boxes, the space between the outer and inner box being filled with ice; so that cold meat, pies, tarts, butter, or any article requiring to be kept cool, is set on the shelves of one of these presses with no more trouble than they would be set on the shelf of a common press. It may be interesting to some of our readers to know that the greatest dealer in ice in London, or perhaps in the world, is Mr. Leftwich of Albany Street, Regent's Park; and the next, perhaps, Mr. Symonds of Southgate. The ice-house at Southgate is 36 ft. deep, measuring from the surface, and 14 ft. high above the surface. It is circular, and 24 ft. in diameter, at the surface of the ground; 18 ft. at the bottom; and the dome

165



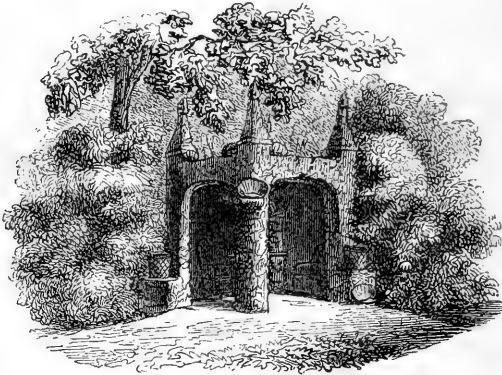
90

at top rises in the form of a cone. This house, it is computed, will contain 450 tons of ice.  
 5, The smaller kitchen-garden.



- 6, Broad border for pits; and in which there is a cold-pit for protecting vegetables during winter.
- 7, Boundary plantation.

- 8, Angular brick wall, for the sake of having different aspects for the fruit trees which are trained against it; and for strength, being only one brick in thickness for lessening the expense.
- 9, Pond in the largest kitchen-garden, supplied from the brook by pipes, with waste pipe to the pond on the lawn.
- 10, Filbert plantation.
- 11, Orchard, and boundary plantation.
- 12, Covered seat; of which a view is shown in *fig.* 166. In front of this seat there is a mulberry tree of large dimensions,



166

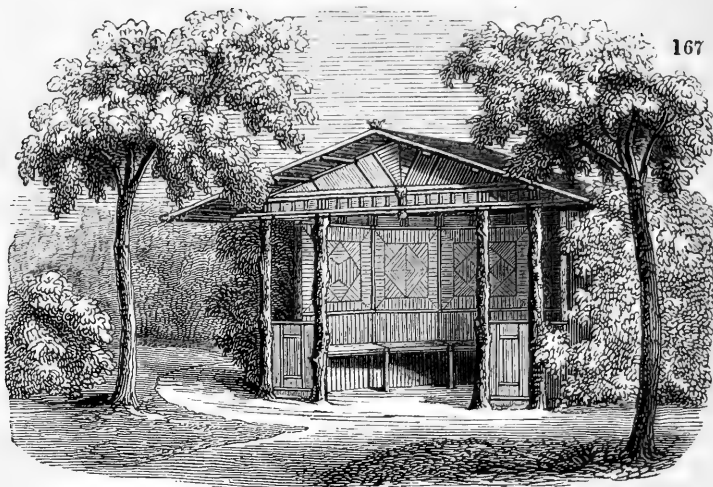
*Covered Seat, of grotesque and rustic Masonry.*

- which was transplanted by Mr. Harrison when it was upwards of 80 years of age. The instruments with which a number of large plants, particularly shrubs, were transplanted under Mr. Harrison's directions, when the grounds were being altered and enlarged, were described for us by Mr. Pratt. (See *Gardener's Magazine*, vol. xi. p. 134.) Mr. Pratt kept for many years large plants which had suffered from any causes, or which were not immediately wanted, in what he called an hospital for these purposes.
- 13, A flower-garden, in which for several years a large *Araucaria brasiliensis* stood out in the centre bed; but it was killed to the ground in the winter of 1837—8.
  - 14, The rustic covered seat, shown in *fig.* 167. in p. 660., and of which *fig.* 168. is an elevation of the back; showing the manner in which the barked poles are arranged.
  - 15, Basin of water for aquatics.
  - 16, Rustic building, of which a view is shown in *fig.* 172. In the interior is an alto-relievo of statuary marble, representing a female over a funereal vase, surrounded by a sort of broad frame of corals, cornua Ammonis, and large mineral specimens of different kinds.
  - 17, Groups of roses, dahlias, and other ornamental flowers.



- 18, Two semicircular beds of roses.
- 19, A covered double seat, one half looking towards the roses, and the other in the opposite direction. In the latter are kept the instruments for playing at what is called lawn billiards, which is said to be a game intermediate between bowls and common billiards. This game is little known, but materials for playing at it are sold by Messrs. Cato & Son, wire-workers, Holborn Hill, London, who send out with them the following printed rules : —
- “ This game, which differs from all others, should be played on a lawn about 12 yards square ; the socket with the ring being fixed in the centre, by a block of wood fixed into the earth. It may be played by two or four persons, either separately, or as partners, each player having a ball with a cue pointed to correspond. Care must be taken to fix the ring at the end of the cue close to the ball before striking.”
- 20, The pond. On the margin of which, at *k*, is the boat-house seen in *fig.* 173. in p. 667.
- 21, Descending steps through evergreens ; from which is seen the distant view of the house and the tent, as in *fig.* 163. in p. 653.      22, Dahlia plantation.
- 23, Chinese temple, from the interior of which is obtained the view shown in *fig.* 162. in p. 651. Behind the temple, a little to one side, is the grotto shown at 91 in the plan, *fig.* 159. in p. 642, 643. ; and also in the view, *fig.* 164. in p. 654.
- 24, The situation of the tent shown in *fig.* 163.
- 25, The different flower and shrub gardens described in detail in the plan, *fig.* 159. p. 642, 643.
- 26, The hot-houses, pits, frames, farm-buildings, &c., shown in *fig.* 159.
- 27, Grass fields, forming part of the farm.
- 28, Point from which the view of the hot-houses, *fig.* 161. in p. 646., is taken ; and also, turning round, the view of the house, *fig.* 174. in p. 669.      29, Secret entrance to the grounds.
- 30, Principal entrance to the house.
- 31, Entrance to the stable-court and farmyard.

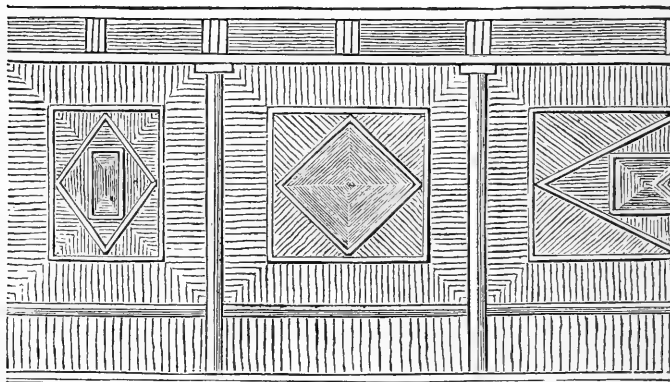
*Remarks.* — In pointing out the principal sources of the professional instruction which a young gardener may derive from examining this place, we shall first direct attention to the garden structures. These, whether of the ornamental or useful kind, are executed substantially, and with great care and neatness ; while the farm-buildings, being chiefly of wood, show how great an extent of accommodation may be obtained without regularity of plan, and without incurring much expense. A good exercise for the young designer would be, to distribute the same accommodation, properly classed, along the sides of a square or squares, or along the sides of a parallelogram or



*Rustic covered Seat, of Woodwork.*

polygon, and either detached from, or connected with, the horticultural buildings.

The manner in which the working-sheds are heated by the waste heat from the furnaces, in consequence of which, in severe



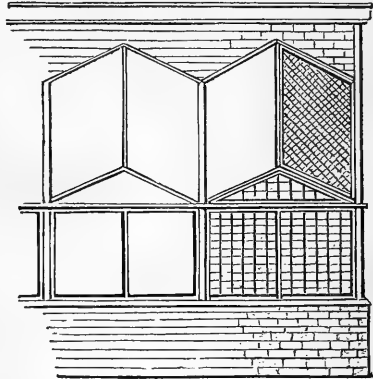
*Elevation of the Back.*

weather, much more work will be done in them, and in a better manner, and in which they are lighted, so as to serve for protecting certain kinds of plants during winter, is worthy of imitation; as is the mode of heating so many different houses from only three boilers. In no garden structures have we seen a more judicious use of the Penrhyn slate; paths, edgings, shelves, cisterns, boxes for plants, copings, kerbs, partitions, and substitutes for dwarf walls, being all made of it. The

order and neatness with which all the different tools, utensils, &c., are kept in the horticultural and farm buildings, are most exemplary, and greatly facilitate the despatch of business.

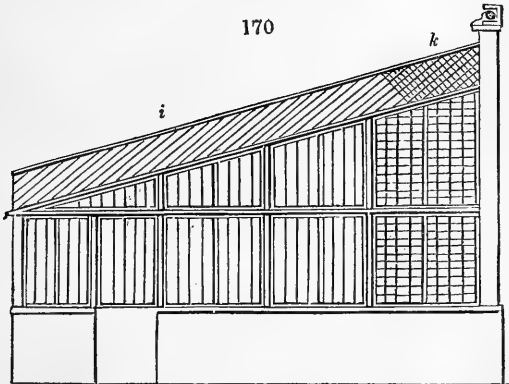
In the construction of the hot-houses, the most remarkable is one on the ridge and furrow principle of Mr. Paxton, accurately copied from the original house at Chatsworth; and, as this is the only house of the kind that we know of within the same distance of London, we shall give a plan, elevation, and view of it. This house is marked 7 and 8 in the ground plan, *fig. 159.* in p. 642, 643.; one half of it being used as a geranium-house, and the other as a botanic stove.

*Fig. 169.* is a geometrical elevation of part of the front of this house, showing, in a conspicuous manner, the ridges and furrows. Ventilation is given by opening the glazed triangular panel in front of each ridge, which is hinged on its lower side; and by the opening of shutters of similar form and dimensions in the back wall, under the upper part of the ridge.



169

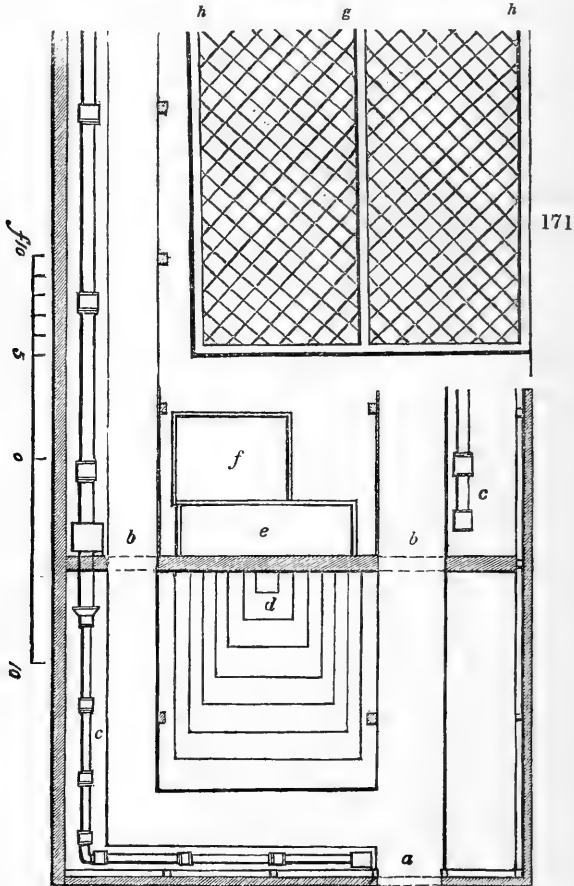
*Fig. 170.* is a cross section through the middle of one of the ridges of the roof, in which are shown at *i* the oblique direction



170

of the sash bars between the ridge and the furrow, and the panes of glass put in at right angles to the bars at *k*. There are openings under each ridge, in the back wall, and also in front, for ventilation.

*Fig. 171.* is a ground plan of a portion of this house, showing the entrance at *a*; a partition, by which a part of the house may be treated as a stove, *b b*; the hot-water pipes, *c c*; the stage for green-house plants, *d*; cistern for water in the stove division, *e*; and box for *Musa Cavendishii*, *f*. The cistern and the box are formed of slabs of slate, held together by iron



bolts, which pass through the two opposite plates, and are made fast with screws and nuts.

*Fig. 170.* *h, g, h,* is a vertical profile of part of a ridge on a large scale, in which *g* is the ridge piece, or crown of the ridge; and *h h* the gutters or furrows. The width of these ridges, from furrow to furrow, is about 6 ft.; and the height, from the level of the furrow to the crown of the ridge, is about 3 ft. The advantages attending this kind of house have been already noticed, p. 452.

The following memorandum respecting the heating of the hot-houses and pits at this place has been kindly supplied by Mr. Harrison.

“The hot-water apparatus first used in the small house in the walled garden, 3 in *fig.* 159. in p. 652., was put up by a regular mechanic from London, but worked so ill and with such frequent failures, requiring night-watching, that soon after Mr. Pratt became head gardener the whole was taken to pieces, and the materials, with additions and alterations, and removing the boiler from the house into an adjoining place where the fire and flue were built, were reconstructed, and the house has completely answered ever since.

“Since that time no person supplying hot-water apparatus has ever been consulted, or even employed, except in casting boilers and other iron work, according to plans and drawings made to a scale and sent to London; these materials being put together by a smith in the country, who has learned to cut and join pipes. Three fires heat eight distinct houses; and if the whole had been erected, or its erection contemplated, at the same time, two fires would have been amply sufficient, by placing the houses requiring most heat nearest the fires. One of the boilers is a common large iron coal box, which has now been in use seven years, without the slightest failure. Simplicity in construction, with large bodies of water and iron (the pipes in the largest house being 6 in. internal diameter, in the others 4 in., and going entirely round the pine and orchideous houses, requiring the greatest heat, and round three sides of the botanic house), has been the basis of all the plans; and experience derived from the house in the walled garden has led to the exclusion of all the boilers from the other houses, the delivering and return pipes being in every instance carried from the boilers through the wall, and close fitted; and experience has proved that the advantages of this mode more than compensate, in various ways, for the loss of heat which the boilers would give in the houses.

“Experiments have also proved that the 6-inch pipes in the botanic house, which is considerably more than double the area of the pine-house which is heated from the same boiler by 4-inch pipes, give a greater heat than would be given by a double set of 4-inch pipes, making full allowance even for the excess of water beyond the double quantity carried by the 6-inch pipes above the 4-inch, calculated on the squares of their diameters. This proves that the same quantity of water is more effectual when distributed in large pipes, than in a greater number of smaller pipes. No deficiency has been found in the regular diffusion of heat, and great advantage in the continuance. The pipes through the wall delivering and returning the water in the orchideous house, which supply two sets of service pipes branching off at opposite right

*Hermit's Seat, and Classical Vase.*

angles, were cast with the boiler, on the calculation of the squares of the diameters, the service pipes being 4 in., and the others nearly 6 in.

“These arrangements have now had sufficient trial to prove their efficiency. Mr. Pratt can give and secure the continuance of whatever heat he considers necessary, without any attention to the fires during the night. It was necessary to look at the fires in the night during the use of a very highly praised boiler, which was obliged to be used in consequence of failure in procuring a large coalbox, and the founders not being able to send the present boiler in time. Since the present boiler has been fixed, neither Mr. Pratt nor any one under him has ever looked at a fire during the night; the temperature of the houses in the morning, after the severest night, proving the absolute security of the mode of supplying the heat under these houses.

“The economy and simplicity of plan have also been proved by Mr. Harrison having, previously to heating the second house, had an estimate made by an eminent London firm, of the cost of the apparatus for heating the house, the dimensions of which were given. Estimate, 58*l*. Mr. Harrison objected to the estimate, and desired to have another, with the plan of heating on which the estimate was founded: this was 52*l*. Mr. Harrison, disapproving both of plan and estimate, made, with Mr. Pratt, a plan, the iron for which was supplied by the same firm, and amounted

to 26*l.*, instead of 52*l.*; and this plan, at half the cost of the other, has most completely answered in every respect. No estimate or plan from London has since been required. It may be added, that Mr. Pratt is now satisfied from experience, that economy in fuel and in labour in attending fires, and the avoidance of night-watching, as well as economy in the first cost, are attained by simple instead of by complicated plans.

“Any required heat, however high, may be given, and distributed and regulated by the stop-cocks in the different houses, and retained during the severest weather without any care during the night. Mr. Pratt has ascertained that 420 gallons, the largest quantity of water used in the new houses, can be boiled in an hour; and, when it is considered that during the greater part of the year, and the whole of that part in which sudden severe cold can occur, the water in the boiler must always be kept at a certain temperature for the use of the pine and orchideous houses, and generally also let into the botanic house, no difficulty can occur in the other houses. He has found that the upper pipes in the geranium and heath houses become hot in five minutes after the cocks are turned to let in the hot water from the adjoining houses. It must be added, that great care should be taken in the construction of the fireplace and flue; as a most important difference will be found between a wide and ill-constructed fireplace and flue, both in the intensity of heat by any given quantity of fluid, and in the burning of inferior fuel mixed with good; in the keeping in of the fire, and preventing any accumulation of soot, &c. The fireplaces and flues have all been constructed under Mr. Pratt’s own immediate superintendence.

“The result is, a decided superiority in economy, in first cost, in the use, and in security without-night watching, of simple over complicated plans: and this detail has been given, which might be extended to more minute points if required, in the hope that it may prove useful to amateur gardeners who require hot-houses, and to those who supply apparatus for heating. Many persons deny themselves a luxury they wish to enjoy, from the expense and occasional failures of many of the complicated plans now in use; and more numerous orders, which would be given if the above objections were remedied, would amply compensate those who supply such apparatus. — W. H.”

In the farm-buildings, the fittings up of the poultry-houses, the rabbit-house, and the dairy and dairy scullery, well deserve attention; and also the arrangement for fermenting the food of the pigs in under-ground cisterns, not too warm for summer, nor so cold as to check fermentation in winter. The manure of the horses, of the cows, of the pigs, of the rabbits, of the pigeons, and of the poultry, is kept in separate pits, that it may be used, if desirable, in making up different composts.

three liquid-manure tanks, in which the liquid matter, which in most farmyards is wasted, is fermented, and afterwards mixed up with soil for use in the kitchen-garden, or used in forming composts for particular plants. The liquid manure from the stables is kept apart from that from the cow-house; and the general drainings of the yard, and of the frame-ground in the kitchen-garden, are fermented by themselves. The liquid manure with which Mr. Pratt waters his plants is formed chiefly of the sweepings of the pigeon, rabbit, and cow houses, with lime; and is kept in a cask in a close shed (60 in the plan *fig.* 159. in p. 642, 643.), so that the temperature admits of its fermenting in winter, as well as in summer: a thick scum rises to the top of the cask, and the liquid is drawn out from the bottom as clear as old ale. The plants which Mr. Pratt waters with this liquid are chiefly those of rapid growth, such as the *Datùra*, *Brugmánsia*, and other soft-wooded tree plants which, like these, are cut in every year, and appear to profit by the stimulating effect of this manure. He gives it also, occasionally, to various other plants which appear to want vigour; but has not yet had sufficient experience of its effects, to give a list of plants to which it ought to be applied.

In order to produce as much manure as possible, as well for the farm as for the garden, all leaves, haulm, and waste vegetable matters, are carefully collected, and fermented by the addition of fresh stable dung; and heaps of different kinds of soils, procured from different parts of the country, are constantly kept in the slip adjoining the frame-ground, ready for use.

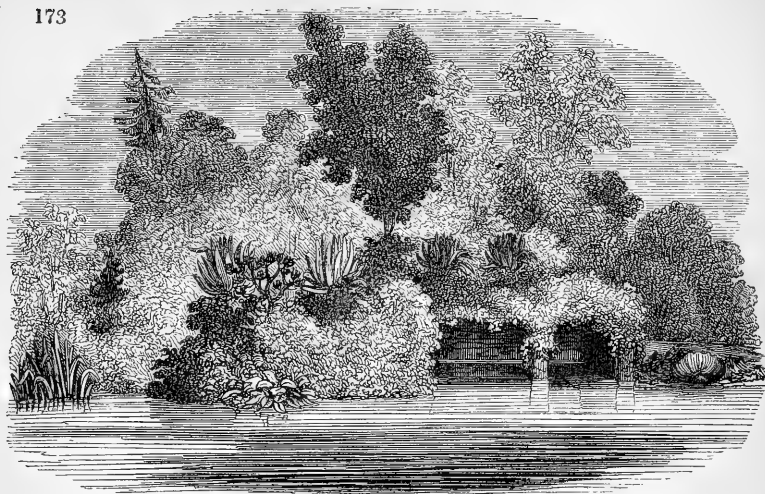
The grounds being nearly level are readily supplied with water from the ponds and from the brook; and there are concealed wells, communicating with these sources by pipes from the brook, in different parts of the grounds, and more especially in the kitchen-garden, from which the plants can be abundantly watered in the growing season with comparatively little labour; there being six different places, including the ponds and brook, from which the gardeners take water, and all the strawberries are planted close to the wells in the inner and outer walled gardens.

The kitchen-gardens, the hot-houses, and the store-houses and some other structures can be locked up at pleasure, Mr. Harrison and Mr. Pratt being the only persons having complete master keys. Part of the outer kitchen-garden is enclosed with an open iron spike fence, 5 ft. 6 in. high, within which and the inner walled garden are the strawberries and choicest gooseberries, figs, &c., and these enclosures are opened only by the master keys. The whole, therefore, of the wall and best fruit is secured from plunder.

The beauties of this place, as has been already mentioned, depend chiefly on the taste and judgment displayed in laying out



173



Boat-house and Agave Mount.

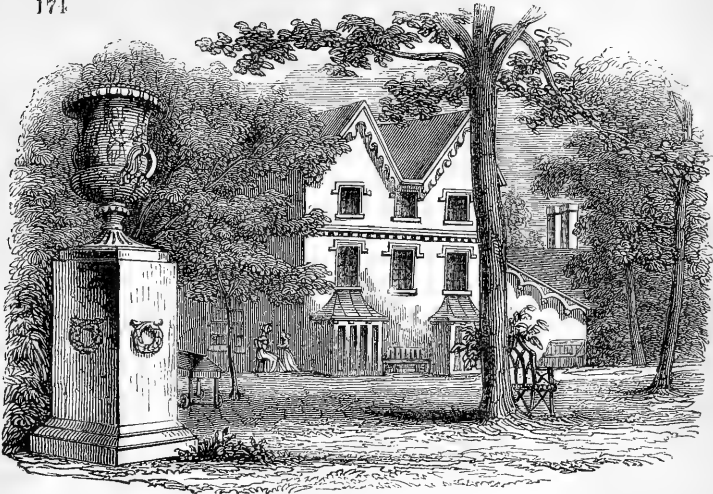
the walks, and distributing the trees and shrubs; though the choice of a situation for the pond, and the mount adjoining it, is also a matter of some consequence.

The trees and shrubs, being comparatively limited in number, consist of one of almost every kind that is to be procured in British nurseries, exclusive of those which are common, or not considered ornamental. In selecting these, the more rare kinds have been procured, and planted quite young; Mr. Harrison and Mr. Pratt having found, by experience, that the pines and firs should be planted out when not more than of three or four years' growth. When the plants have been in pots, the balls should be gently broken with the hand, and afterwards all the earth washed away from the roots by the application of water. The plant may then be placed on a hill of prepared mould, and the roots stretched out, so as to radiate from the plant in every direction, and afterwards covered with mould. This is the mode adopted by Mr. Barron at Elvaston Castle, of which more hereafter. A list of Mr. Harrison's very choice collections of *Abiétinæ* and *Cuprèssinæ*, has been given in our *Arboretum*, vol. iv. p. 2450., and in this Magazine, vol. xiv. p. 30. These pines and firs are in a most healthy state; and *Pinus excélsa*, *P. inops*, and *P. Banksiàna*, *Picea pectinàta*, *Cèdrus Deodàra*, and *Abies Douglàsii* are remarkably fine specimens.

The masses of trees and shrubs are chiefly on the mount near the lake, and along the margin which shuts out the kitchen-garden; and in these places they are planted in the gardenesque manner, so as to produce irregular groups of trees, with masses of evergreen and deciduous shrubs as undergrowth, intersected

by glades of turf. They are scattered over the general surface of the lawn, so as to produce a continually varying effect, as viewed from the walks; and so as to disguise the boundary, and prevent the eye from seeing from one extremity of the grounds to the other, and thus ascertain their extent. The only points at which the lawn is seen directly across from the drawingroom window are in the direction of *l* and *m*, *fig.* 165. in p. 656, 657.; but, through these openings, the grass field beyond appears united with the lawn; so that the extent thus given to the views from the drawingroom windows is of the greatest assistance to the character of the place, with reference to extent. From every other part of the grounds, the views across the lawn are interrupted by some tree, bush, or object which conceals the boundary; or, if the boundary is seen on one side, as in passing along the walk from 16 by 18 to 22, there is ample space on the lawn side to keep up the idea of extent.

In many situations, this walk, as seen on paper, would be considered to be too near the boundary; but in the grounds the narrow plantation from 22 to 18 is of evergreens, chiefly hollies, which already partially shut out all view of the boundary or the field, and which are ultimately intended to spread their upper branches over the walk, so as to give it a character of shade and gloom, different from any other in these grounds. In general, it may be laid down as a rule, that the boundary between a lawn and the park or field beyond should not be such as to cut the landscape, as it were, in two; and another rule is, that the walks should never be so near this fence, or should not be so conducted when near it, as to admit of the spectator looking directly across. Indeed, in scenery, no rule is generally more applicable than this; viz. that all straight lines, whether fences, roads, canals, or rivers, and all regular symmetrical objects, such as buildings, should be looked at obliquely. Applying this rule, therefore, to the scenery between the walk and the fence, from 18 to 16, we should say that either the direction of the walk ought to be altered, so as to remove it further from the boundary, or the boundary extended further into the field; and instead of being bordered by a hedge-like fringe of shrubs, it should only be broken here and there by occasional bushes and trees, connected and harmonising in position with other trees beyond the fence. If it were desirable to avoid altering the boundary, then we should recommend continuing the walk which commences at *d* near 19, by *n* and *o o*, to *p* near 16. If there were nothing to see or be seen beyond the boundary, then, unless the boundary fence were a conservative wall, that is, a wall covered with half-hardy ornamental plants, we should still prefer changing the direction of the walk, so as to take away from the monotonous appearance of continually skirting the boundary. In every



Garden Front of Cheshunt Cottage.

place, however small, there ought to be some part left which the visitor has not seen, and which may leave the impression on his mind, that, however much he has been shown, he has not seen every thing. We make these observations with great deference to Mr. Harrison, who has paid much attention to the subject of landscape-gardening, and shown much practical taste and good sense both in that art and in architecture.

It is, however, right to state that Mr. Harrison accords with our general view of the subject, but “defends the walk in question as an exception founded on his objects in making it; which were, 1st, to have a walk different from any other in the garden, and, 2d, a walk sheltered from the winter southerly gales, and ornamented by the bloom of the *laurustinus* at that season. It is, therefore, so slightly curved as merely to avoid a straight line; and permits an extent of length not found in any other part to be seen on descending the elevation at the east end, or on emerging from wood at the west end, where, when the improvements connected with it are finished, it will enter a dense plantation, the walk going round at the back of the building in that corner. The fence would have been entirely excluded from either near or distant view, and the eye carried so as not to catch a view of the grounds of the field nearer than one hundred yards or more at the least, if the *laurustinuses* had not suffered so severely in 1837-38; but these will, by next year, and by trees already planted along the border, and others to be planted irregularly, at intervals, in the field near the fence, in a great measure, Mr. Harrison thinks, obviate the objection made, or, at

least, lessen the force of it, as future appearances will, he thinks, prove. — W. H.”

The trees and shrubs on the lawn are almost all disposed in the gardenesque manner; that is, so that each individual plant may assume its natural shape and habit of growth. The masses are also chiefly planted in the same style; and, as the trees and shrubs advance in growth, they are cut in, or thinned out; so that each individual, if separated from the mass to which it belongs, and considered by itself alone, shall be a handsome plant. At the same time, in order to produce as much variety as possible, the picturesque style of planting, in which trees and shrubs are so closely grouped together as partially to injure each other's growth, occasionally occurs, for the sake of producing variety. With the exception of the pines and firs, the other trees have been selected more for their picturesque effect and variety of foliage, than for their botanical interest. Among these are the Scotch pine for its darkness; the *Pópulus angulàta* for its large leaves, and for its property of preserving these till destroyed by severe frost, long before which all the other poplars have become naked; the *Acer macrophýllum*, for its large leaves; the Montpellier maple, for its small ones; the *Negúndo fraxinifólium*, for its green-barked shoots; the American oaks, for the singular variety in form and colour of their foliage; the catalpa, for its broad rich yellowish leaves, and its showy blossoms, which appear late in the season; the deciduous cypress; the bonduc, or Kentucky coffee tree; the cut-leaved alder; the tulip tree; the purple beech; the purple hazel; the Oriental plane, of which there are several fine specimens; the variegated sycamore, and other variegated trees and shrubs, which are always so beautiful in spring; those thorns and crabs which are beautiful or remarkable for their blossoms in the spring, and for their fruit in autumn; the Nepal sorbus, so interesting for its large woolly leaves, which die off of a fine straw colour; the magnolias; the rhododendrons; the heaths; the brooms; and the double-blossomed furze; besides various striking or popular plants, such as the variegated hollies, the scarlet arbutus, &c. Among the detached trees and small groups, there is scarcely to be met with a single bush or tree that a general observer will not find noticeable for something in its foliage, general form, flowers, or fruit. The *Magnòlia grandiflòra* var. *exoniénsis* flowers freely as a standard without any protection, and was not even injured by the winter of 1837–8; nor was *Arbutus procèra*, also unprotected. A number of the more rare trees and shrubs, such as *Araucària brasiliénsis*, which had stood out eight years, *A. Cunninghàmi*, *Pinus insígnis*, *P. palústris*, *P. Gerardiàna*, *P. canariénsis*, &c., were killed during the winter of 1837–8; and a number of others, which were severely injured, are now re-

covering. Mr. Pratt, the head gardener, did not begin to prune the trees which were injured, till the rising of the sap showed the extent of the injury that they had received. After waiting till the middle of summer, it was found that the laurestinus, sweet bay, Chinese privet, and various other shrubs, were alive to the height of from 3 ft. to 5 ft.; and, after the dead wood was cut out, the plants soon became covered with young shoots and foliage.

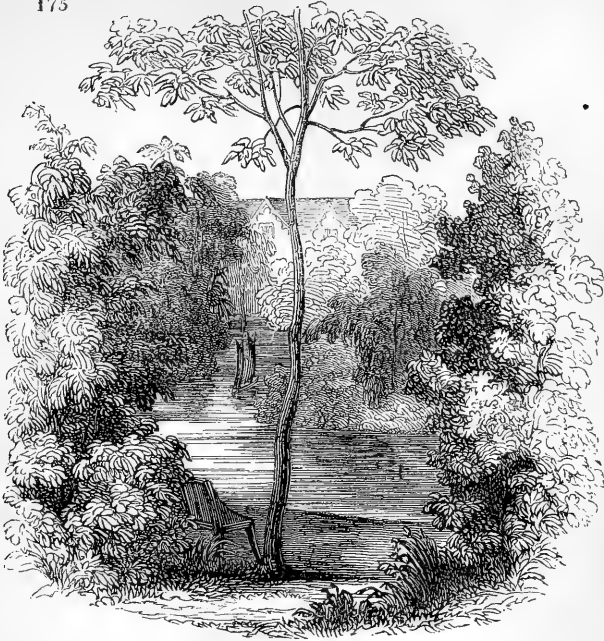
*The Walks* are so laid out and planted as to be sheltered or bordered by evergreens, for the sake of their lively appearance during winter. They are also so contrived as to be shaded from the sun by deciduous trees during summer; while these trees, being naked during winter, admit the sun at that season to dry the ground. The walks are laid out in different directions, in order that, from whatever point the wind may blow, at least one walk will be sheltered from it. The greater number are in the direction of north and south; because walks in that direction are best exposed to the sun in the winter season, which is the period of the year in which the proprietor chiefly resides here. It is always desirable, in a small place, that all the walks should be concealed from the windows, except that immediately under the eye; and that, in walking through the grounds, no path should be seen except the one walked on, and that (except in the case of a straight avenue) only for a moderate distance. These rules (derived from the principle of variety and intricacy) have been carefully attended to by Mr. Harrison; and hence the walk from *a* to *b*, in the plan *fig.* 165. in p. 656, 657., is concealed by raising the turf on the side next the house higher than on the opposite side; while that from *c* to *d* is concealed by the bushes and trees at *e*, and more especially by a large rhododendron at *ee*. The walk *f g h* is concealed from the walk *i*; partly by a swell in the surface of the turf on the side next *i*, but chiefly by the bushes which are scattered along its margin. At *g*, there is a clump which prevents any one on the walk *i* from seeing the line *g f*; and any one on the walk *g f* from seeing the line *i*. In walking along from *f* to *h*, it is clear that the trees and shrubs on the left hand will always prevent the eye from seeing the walk to any great distance. All the other walks through the lawn are concealed in a similar manner; so that a person walking in the grounds never sees any other walk than that which lies immediately before him; and, therefore, in looking across the lawn, he never can discover the extent either of what he has seen, or of what he has yet to see. To form a great number of walks of this sort, and lead the spectator over them without showing him more than one walk at a time, but taking care, at the same time, to let him have frequent and extensive views across the lawn,

and these views always different, constitute the grand secret of making a small place look large.

The walks are filled to the brim with gravel, kept firmly rolled, and their grass margins are clipped, but never cut; because the gravel, being almost as high as the turf, the latter can never sink down, and swell out over the former. This it invariably does when the turf is a few inches higher than the gravel; and, hence, paring off the part of the turf which had projected was originally, no doubt, adopted only as a remedy for the evil, though it is now erroneously practised by gardeners as an evidence of care and good keeping. As much of the beauty of the walk depends upon the beauty of its boundary, the feeling that this boundary is likely to be disturbed every time the walk is cleaned, or the adjoining turf mown, is extremely disagreeable. The freshly pared turf becomes a spot or a scar in the scene, withdrawing the attention from the walk itself, and from the adjoining grounds, to a point, or rather a line, which is in itself of little consequence, but which, by the paring, is obtruded on the eye, so as to destroy all allusion to stability. We are displeased with the paring of the edges, because it conveys the idea that the walks are not finished, or that they are liable to be disturbed in this way from time to time; and nothing, either in grounds or in buildings, is more unsatisfactory than an apparent want of stability or fixedness. It is as much the nature of the ground to be fixed and immovable, as it is of trees and shrubs to increase in growth; and, hence, any operation, such as clipping, which seems to stop the growth of the one, is as unsatisfactory to the eye as paring, which seems to derange the fixed state of the other. Would that we could impress this on the minds of all gardeners and their employers!

*The Pond* is of an irregular shape, so arranged as with the assistance of the island to prevent the whole of it, and consequently its limited extent, from being seen from any one point in the garden. For the same reason, the walk only goes along one side, there being but one point on the western side, viz. where the iron seats are close to the agaves, from which any part of the pond can be seen. The pond is so situated as to form the main feature in the right-hand view from the drawingroom window, as shown in *fig. 156.* in p. 636.; the wooded island (which is shown rather too much in the middle in the plan, though, perhaps, not so in reality) disguising the boundary from that and every other point of view. The bank of the pond on one side is rocky, and nearly perpendicular; while on the other it is sloping, and partly covered with shrubs. At *k* in *fig. 165.* in p. 657., there is a boat-house, on the top of which are several large agaves, the common, the variegated, and *Agave plicatilis*; the tubs containing which are so disguised by rockwork, as to create an allusion to the

175



*View across the Water, looking towards the House.*

appearance of these plants in their native habitats. The appearance of these agaves, and also of a large crassula, is indicated in a view of the boat-house, *fig.* 173. in p. 667.; and it is only from a seat among these agaves that any part of the pond can be seen from this side of it. Had a walk been conducted completely round the pond, and near its margin, the charm of partial concealment would have been entirely lost. The high banks have been formed with earth taken out of the pond, and these have given occasion to a considerable variety in the inclination, as well as in the direction, of the walks. The banks are planted on the same principle as the open lawn; that is, with trees and shrubs having striking foliage or showy flowers, and with a judicious mixture of evergreens to give the effect of cheerfulness in winter. In the water are two large plants of *Cálla æthiópica* *Lin.*, which cover a space of nearly 5 ft. in diameter; they have lived there through ten winters without any protection, the water being 5 ft. deep; and they flower luxuriantly every year. The views across the water, to the house and to the other parts of the grounds, are singularly varied, owing to the winding direction of the walk, and the consequently changing position of the island, and of the trees in

the foreground and middle distance. One of these views may be seen in *fig.* 175. and others have been already given in p. 636. 651. 653. 667.

*The Flower-Garden* (25, in *fig.* 165. in p. 656, 657.) is laid out, as the ground plan indicates, in beds, everywhere bordered with slate: a flower-garden of this kind, with the walks gravelled, having the advantage of rendering the flowers accessible to ladies immediately after rain, when they are often in their greatest beauty, and, at all events, in their greatest freshness and vigour; an advantage which is not obtained when the beds are on turf. There are also flower-beds on turf in other parts of the grounds: but these are filled with roses, dahlias, and other large-growing plants in masses, the beauties of which do not require to be closely examined.

*The Management* of the garden, farm-yard, and everything except the interior of the dwelling-house, is committed to Mr. Pratt, who is not only an admirable manager, but an excellent gardener; as the number of prizes which he has obtained at numerous floricultural exhibitions, as well as the beautiful manner in which he cultivates rare plants, and grows the more ordinary flowers and garden produce, amply testifies. He is also a singularly modest unassuming man. There is scarcely an operation connected with the management of a grass farm, and the treatment of all the various kinds of live stock which we have noticed, that Mr. Pratt is not as successful in performing, as he is in cultivating plants.

*Bayswater, August, 1839.*

---

## ART. II. *Provincial Horticultural, Botanical, Floricultural, Agricultural, and Zoological Societies.*

OUR notices of these societies, this year, commence with November 1. 1838, and extend to November 1. 1839; and they are intended to be little more than the registration of their names. The reason is, they have for the most part been fully reported in the *Gardener's Gazette*, a journal which is, or ought to be, in the hands of all our readers. Whenever a newspaper or letter has been sent us, containing information respecting any society, we have given that newspaper or letter as an authority; but in all other cases we have merely given the title of the society, and a reference to the page in the *Gardener's Gazette* where its transactions will be found in detail.

### ENGLAND.

BEDFORDSHIRE. — *Biggleswade Horticultural Society.* — For spring show, see *Gard. Gaz.*, 1839, p. 148. — *Sept.* 23. See *Ibid.*, p. 676.

*Bedford open Dahlia Show.* — *Sept.* 17. See *Ibid.*, p. 693.

BERKSHIRE. — *Farringdon Horticultural Society.* — Spring show. See *Ibid.*, p. 396.

*Windsor and Eton Royal Horticultural Society.* — *July* 13. See *Ibid.*, p. 453.

*Sunbury Royal Horticultural Society.* — *Sept.* 17. See *Ibid.*, p. 645.



*Royal Berks Horticultural Society.* — The first show was held June 24.; when the following cottagers received premiums: — Joseph Gearing of Wallingford, the annual premium of 5*l.*, given by Her Royal Highness the Duchess of Kent. Simon Pitson of Nuneham, the premium of 2*l.* 2*s.*, given by W. S. Blackstone, Esq., M.P. William Granger of Wallingford, the premium of 1*l.* 1*s.*, given by Miss Blackstone. Thomas Mills of Nuneham, the premium of 1*l.* 1*s.*, given by John Marshall, Esq. Joseph Granger of Wallingford, the premium of 1*l.* 1*s.*, given by E. H. Payne, Esq. John Granger of Wallingford, the premium of 1*l.* 1*s.*, given by W. Cooke, Esq. (*Jackson's Oxford Journal*, June 1., 1839.)

*Reading Horticultural Society.* — The show on July 24. was less striking than on former occasions.

BUCKINGHAMSHIRE. — *Buckingham Domestic Horticultural Society.* — August 13. See *Gard. Gaz.*, 1839, p. 600.

*Aylesbury Floral and Horticultural Society.* — See *Ibid.*, p. 839.

CAMBRIDGESHIRE. — *Bourn Grand Dahlia Show.* — Sept. 17. 1838. See *Ibid.*, 1839, p. 76.

*Cambridgeshire Horticultural Society.* — March 27. See *Ibid.*, p. 236. — July 24. *Ibid.*, p. 501.

*Wisbeach Horticultural Society.* — May 31. See *Ibid.*, p. 389.

*Cambridge Amateur Florists' Society.* — Sept. 17. See *Ibid.*, p. 629.

CHESHIRE. — *Staley Bridge Tulip Exhibition.* See *Ibid.*, p. 412.

*Altringham Floral and Horticultural Society.* — June 6. See *Ibid.*, p. 397.

CORNWALL. — *Royal Horticultural Society.* — The exhibition of May 28. was held in the National Schoolroom at Redruth for the first time, to the high gratification of the inhabitants of the locality. Mr. W. Tweedie, Esq., addressed the company, noticing the very great improvement that had taken place in the horticulture of Cornwall since the establishment of the Society, and directing attention to many rare plants in the present exhibition. He also referred to a letter received from Dr. Wallich by Sir Charles Lemon, stating that the doctor had forwarded from India a box of growing plants, addressed to the Society; and requesting that the box might be sent back to him, replenished with plants of South American or West Indian origin. (*West Briton and Cornwall Advertiser*, May 31.)

July 16. Notice was taken of the great good effected by the cottage garden societies of Cornwall; which, it appears, are cooperating with the Cornwall Royal Horticultural Society so effectually, that many of the premiums for culinary vegetables and flowers, formerly exclusively awarded to professional gardeners, are now carried off by cottagers. (*Ibid.*, July 19.)

CUMBERLAND. — *Penrith Floral and Horticultural Society.* — Sept. 7. 1838. See *Gard. Gaz.*, 1838, p. 765.

*Carlisle Floral and Horticultural Society.* — Oct. 2. See *Ibid.*, p. 837.

*Whitehaven Horticultural Society.* — At the meeting of May 9., prizes were awarded for auriculas, polyanthuses, and various other florist's flowers, showy or rare plants, and culinary vegetables. A quantity of rhubarb, sea-kale; asparagus, and tulips were brought from Mr. Williamson Peile's garden in Countess Pit, in Parton Colliery, at the depth of 85 fathoms, and at a temperature of 66°. The rhubarb was planted on the 12th ult., the sea-kale on the 26th, and a prize was awarded to each. (*Cumberland Packet*, May 14.)

Aug. 22. A model of St. James's Church, constructed of everlastings, was exhibited by Mr. Robert Elliot, gardener at Rose Hill, and was very much admired.

Sept. 26. Specimens of grass, corn, radishes, &c., grown by Mr. Stockdale of Cark, in the sand of Morecambe Bay, were shown in this room, and attracted a good deal of notice. The grass was of great length; and a tall, strong, and heavy-laden bean-stalk towered nobly in the centre of the smaller curiosities which surrounded it. We heard a gardener remark that the radish shown in this group of singular vegetable productions was as fine a root as he would wish to behold; and a respectable corn-dealer remarked

that the specimen of Morecambe Bay wheat was the best he had seen this year. We ought not to conclude these remarks without stating that Mr. Robert Elliot, gardener at Rosehill, who has frequently shown ingenious pieces of floral architecture at the exhibitions of the Society, this day produced a neat model of a flower-garden, after a plan much in fashion at present at horticultural shows. A board, about 30 in. by 18 in., was covered by a thin layer of green moss, upon which flower beds were laid out, after a very tasteful design. Small flowers were carefully inserted in the beds, completely covering the sand of which the beds were composed, and contrasting prettily with the surrounding moss. In the centre of the model a small pond was placed, containing a miniature group of rocks. Mr. Elliot's model bore marks of being hastily formed, but was much admired; and the plan certainly embodies great capabilities for the exhibition of the smaller kinds of flowers. The judges awarded Mr. Elliot an extra prize for his model. Taken as a whole, this show afforded a convincing proof that the taste for floriculture is increasing in this locality. (*Whitehaven Herald*, Sept. 28.)

*Workington Floral and Horticultural Society.* — Sept. 24. Richard Watts, Esq., of Clifton House, though not a competitor, showed a very kindly feeling to the infant Society by contributing largely in flowers and plants to the decorative department; and amongst other articles which attracted much attention was a very pretty model of a flower-garden. (*Whitehaven Herald*, Sept. 28.)

DERBYSHIRE. — *Derby Tulip Show.* See *Gard. Gaz.*, 1839, p. 454.

*Ashbourn Floral and Horticultural Society.* — Spring show. See *Ibid.*, p. 427.

DEVONSHIRE. — *Devon and Exeter Botanical and Horticultural Society.* — The annual general meeting of this Society was held on Jan. 18., James Wentworth Buller, Esq., in the chair. The report of the committee stated an increase in the number of prizes during the last year, by which the progress of horticulture in this district has been materially improved, particularly the production of useful vegetables; and the rewards given for cottage gardening have been productive of the most beneficial effects, in creating industry and a sense of independence among the cottagers themselves. The rapidly increasing taste for rare exotic plants and flowers is becoming of importance in a commercial point of view, and the exhibitions in Exeter in the last year have surpassed those of all former occasions. The secretary presented an article on the cultivation of the pine-apple, contributed by Mr. Glendinning, gardener to the venerable Lord Rolle, now in his 89th year, at Bicton, which, he stated, contained much important and valuable information on the treatment of this fruit; adding that he could strongly recommend the adoption of this mode of culture, which was founded on scientific principles, and would, if made known to the public generally, prove an important desideratum in this department of horticulture. It was unanimously resolved, that the silver medal of the London Horticultural Society be presented to Mr. Glendinning, together with the best thanks of the Society, and that he be requested to publish the same [see our review of this work, p. 277.], and dedicate it to the Society. (*Exeter Flying Post*, Jan. 19.)

Sept. 27. See *Gard. Gaz.*, p. 660.

*Tavistock and West Devon Agricultural and Horticultural Society.* — At the first annual meeting, September 12, premiums were given for various agricultural and horticultural objects, among which were included pigs, poultry, rabbits, and other articles reared by cottagers. (*Plymouth Weekly Journal*, Sept. 19.)

*Devon and Cornwall Royal Botanical and Horticultural Society.* — May 23. The cottagers' tables were amply stored with the productions usually displayed by them, and many prizes were awarded to this class. Mr. Corbet's plan of heating hot-houses by water circulated in open tubes was spoken of with approbation. (*Plymouth and Devonport Herald*, May 25.)

*Summer Show.* See *Gard. Gaz.*, 1839, p. 627.

*North Devon Horticultural Society.* — June 26. See *Ibid.*, p. 444.<sup>3</sup>

**DORSETSHIRE.** — *The Dorset Horticultural Society.* — August 28. The first exhibition of this Society far exceeded the most sanguine expectations of all concerned. The vegetables exhibited by cottagers exceeded all praise. In every point of view, whether morally or politically considered, the encouragement which is liberally held out by the Society to the industrious cottager, to devote his leisure hours to the cultivation of his garden, instead of frequenting the haunts of dissipation, cannot but be approved of by every person who has the interest of his poorer brethren at heart. (*Salisbury and Wilts Herald*, Sept. 18.)

**DURHAM.** — *Sunderland Floral and Horticultural Society.* — July 11. See *Gard. Gaz.*, 1839, p. 517.

**ESSEX.** — *Chelmsford Floral and Horticultural Society.* — Spring show. See *Ibid.*, p. 412.

*South Essex Horticultural and Floricultural Society.* — June 6. See *Ibid.*, p. 411.

**GLOUCESTERSHIRE.** — *Gloucestershire Zoological, Botanical, and Horticultural Society.* — May 26. See *Ibid.*, p. 364. — July 26. *Ibid.*, p. 563.

*Cirencester Horticultural Show.* — May 31. See *Ibid.*, p. 397. — June 28. *Ibid.*, p. 456.

*Pittville Horticultural Association.* — Spring Show. See *Ibid.*, p. 364. — July 30. *Ibid.*, p. 562.

**HAMPSHIRE.** — *The Hants Horticultural Society* awarded various premiums to the professional gardeners and nurserymen of the neighbourhood, and to cottagers. (*Salisbury Herald*, Nov. 21. 1838.)

*Winchester Horticultural Association.* — Various prizes were awarded. (*Ibid.*, July 6. 1839.)

*Winchester Annual Auricula Show* was held on April 25., when various prizes were awarded, after which followed an excellent dinner. (*Ibid.*)

*Stockbridge Pink Show.* — See *Gard. Gaz.*, 1839, p. 444.

*Winchester Pink Show.* — See *Ibid.*, p. 448.

*Odiham Dahlia and Horticultural Society.* — See *Ibid.*, p. 677.

**HERTFORDSHIRE.** — *Herts Horticultural Society.* — May 2. The show was equal to that of former years. The only specimens which attracted "our attention" in the fruit department "were a quantity of coarse strawberries, of huge dimensions, and most outrageously ugly appearance, which were exhibited by Lord Melbourne." (*County Press*, May 4.)

Sept. 12. The principal attraction of this show was the table of fruit, which included a fine dish of that of the *Musa Cavendishii*. There was a most decided improvement in the number and quality of the cottage productions. (*Hertford Reformer*, Sept. 14.)

*Hitchin Horticultural Exhibition.* — May 10. Many prizes were awarded, especially to nurserymen, market-gardeners, and cottagers. (*Ibid.*)

*The Barnet Horticultural Society.* — May 8. The high reputation of this Society was maintained. (*Ibid.*)

*The North Herts and South Beds Horticultural Society.* — May 10. Many articles were exhibited by Mr. Snow, gardener to Earl de Grey, at Wrest Park, and, on the whole, the display was equal to that of former years. (*Hertford Reformer*, May 18.)

July 5. The show of fruit was not remarkable for any particular specimen. Vegetables were very abundant, and good: but in these the cottagers made science blush; for some of their articles, especially cauliflowers, were infinitely superior to those shown by gentlemen's gardeners. The spirited manner in which the cottagers' prizes were contended for is highly gratifying, and the judges deserve great credit for the liberal manner in which they awarded extra prizes for such specimens as were considered worthy of that distinction. A number of the exhibitors and the judges afterwards dined together, when Mr.

Newton stated that he had attended the dinner at the first exhibition, and though he got plenty of food for the body, the food for the mind was so scarce, and of such an ordinary description, that he had since absented himself. Mr. Fish suggested the propriety of forming a discussional society, contending, that the mere sight of productions of superior quality, without the system by which they had been produced being made known, was not calculated to advance gardening as an art or a science, or to raise gardeners in the estimation of a thinking public. We fully agree with Mr. Fish; and, if it were only as an example to other societies, we should be glad to see his ideas carried into action; but we must say we have our doubts of conducting a useful debate on science, while over the bottle. Indeed, until a spirit of diffusive benevolence becomes more general among gardeners, until the honour conferred by gaining a prize rises superior in the estimation of the exhibitor to the intrinsic value of that prize, we doubt whether any good will accrue from discussion. So long as money is the *primum mobile* with exhibitors, so long will they seek to mystify their proceedings; for it would be expecting too much to suppose that an individual thus influenced would divulge what he considers his secrets, and thus make others as wise as himself, when the very act of doing so would be placing a barrier against his gaining prizes another time: so that, under these circumstances, we place but little reliance upon the good that will emanate from discussion. We, however, recommend Mr. Fish to persevere, and any assistance that we can render him shall not be wanting when it is required. (*Hertford Reformer*, July 13.)

*North Herts Horticultural Society.* — May 10. The beauty and excellence of the articles exhibited excited the greatest admiration. The first prize was given to Mr. Fish, gardener to Col. Sowerby. (*Ibid.*)

*Baldock Horticultural Society.* — May 13. The show was tolerably good, considering the season of the year. (*Ibid.*)

HUNTINGDONSHIRE. — *St. Neot's Horticultural Society.* — Spring show. See *Gard. Gaz.*, 1839, p. 364. — August 5. *Ibid.*, p. 536.

*Huntingdonshire Horticultural Society.* — July 30. See *Ibid.*, p. 520.

KENT. — *Kent and Canterbury Floral and Horticultural Society.* — The different exhibitions seem to have been remarkably well supplied, more especially by Alderman Masters of the Canterbury Nursery, who never shows for competition, but who sends plants to most of the shows held in the county. At the June exhibition, Mr. Masters exhibited eighty sorts of choice roses, and a plantain tree in fruit, a forbidden fruit tree, and some remarkably finely grown orchidaceous plants and Cape heaths. We have already observed that the fruit and vegetables supplied by cottagers were extremely good, giving a foretaste of the great benefit that will result from societies of this nature. They would have done well for competition with many of those furnished by the subscribers. We were glad to perceive this, as an exemplification of what we noticed last year, when speaking of the advantages that must accrue in calling forth the exertions of cottagers. If attending to cultivation is of advantage to any class, it must be especially so to this, who, for the want of some employment or pastime in their leisure hours, too frequently fall into the haunts of the dissolute and idle, and become dishonest and worthless servants. We trust we shall see the feeling fostered of encouraging cottagers to exhibit; and that, at no distant period, we shall witness their efforts in the floral department as well as in the fruit and vegetable.

Upon the herbarium we think we cannot bestow sufficient praise. W. Tiffin Iliff, Esq., F.L.S., and vice-president of the Royal South London Floricultural Society, for whose patronage these Societies are so much indebted, offered a silver medal for the best collection of British plants grown in this county, and obtained since the 1st of September last year. The rules laid down required that the parties exhibiting must be the *bonâ fide* collectors, and that not so much regard would be paid to the number of species, as to the correctness of names and localities, whether plentiful or scarce, and the neatness of drying and arrangement. That which should gain the prize was

also required to be deposited in the Canterbury Museum. There were two collections supplied for competition, one by Mrs. Grayling of this city, and the other by George Smith. The former, for which the medal was awarded, contained about 220 specimens; some of them were very choice, and, indeed, never before seen by some botanists; and the manner in which the rules were complied with reflects the highest credit upon the competing parties. The following are a few of the rarest: — *Achillæa Ptármica*, *Menyanthes trifoliata*, *Hottónia palústris*, *Triglòchin palústre*, *Monótropa Hypópithys*, *Pýrola rotundifolia*, *A'rabis hirsúta*, *Scutellària minor*, *Genísta ánglica*, *Vícia sylvática*, *Thesium linophýllum*, *Althæa officinális*, *Lavátera arbòrea*, *Astrágalus glycyphýllus*. An extra prize was given to Smith. His collection, though not so numerous, contained many very rare sorts. There were about a hundred specimens in his collection, and, as Mr. Iliff observed, they were deserving of much approbation for a working man. By an excellent rule, the collections are deposited in the museum, where they may be seen at a trifling charge. Admirers of botany would be well repaid in inspecting them. Great as was the task of obtaining so many species, we hope to see prizes offered in future for this branch, and we doubt not good results will follow. Here we have, not an assortment of plants cultivated in our gardens, but of those growing in a wild state; which must be particularly interesting to the inhabitants of Kent. They here see what their own native county produces spontaneously. We could not sufficiently admire the rare and beautiful exotics kindly furnished by Mr. Alderman Masters; and, as we think they deserve some notice in our columns, we will endeavour to describe the choicest. *Sábal Blackburniana*, a kind of fan palm, was certainly one of the most distinguished plants in the room. It is rendered interesting to us on account of its being the palm that the pilgrims were accustomed to bring to our cathedral, portions of which are found to this day. *Acácia lophántha*, a native of New Holland, introduced in 1803, the foliage of which is particularly handsome. We regret it was not in flower at the show, but it bids fair to be so in a few weeks. *Acácia decúrrens* is another variety of this genus; and, although it is of a more sombre colour, and not so striking a plant as the other, we could but admire the regularity of its pinnate and delicate foliage. Our attention was also arrested by a new dark variety of *Fúchia fúlgens*, and by *F. fúlgens* itself, which are great acquisitions to this elegant tribe of plants, on account of their very brilliant colours. It will be allowed by every one that the *Músa paradisiaca*, or banana tree of the East Indies, is indeed a curiosity of no common order. The fruit is invaluable to the natives of Jamaica, who can subsist on it for many days without other food. It should be gathered in its present state, and be allowed to ripen after having been cut, when it will assume a brownish yellow colour. *Músa discolor* is one of the most beautiful plants of the same tribe; the leaf on the upper side is of a bright green, whilst the under one is light brown, and, being partially transparent, the mixture forms a colour not to be described. The forbidden fruit, resembling a mango in size and shape, is reported to be the same that tempted Eve: for ourselves, we cannot say that we had much inclination to taste it. *Melaleuca Cajepùti* is the plant from which the cajeput oil is extracted. It is remarkable for its green colour, turpentine smell, and peppermint flavour; and is used as a cure for rheumatic affections, and for preserving preparations in natural history. The plant is a native of the East Indies, and was introduced into this country in 1796. *Pandanus spirális* deservedly excited admiration. It is a plant between 6 ft. and 7 ft. high; the leaves of which are armed with rows of prickles on the three ribs, and wind round each other in a spiral manner. The stem also struck us as being extraordinary. It is not of itself sufficiently strong to bear the large mass of leaves; it therefore pushes forth supporters, which, though small in this country, form arches in its native clime, New South Wales, sufficiently high for persons to walk under. *Sálvia pátens* is a new variety, of a dark blue colour, the flowers of which are more than 1 in. broad. It is a native of South America; and, although but recently

known in this country, it was discovered by Née, a Spanish botanist, some few years since. It is certainly the most splendid of all that have as yet been introduced. *Amarýllis aúlica* is a native of Brazil, and was brought to this country as early as 1658. It is beautifully striate, though, perhaps, not of so brilliant a colour as many of those of a more recent introduction. *Combrètum purpúreum* is a beautiful creeper, assuming different colours, according to the climate; it has even been found white, although purple and scarlet are the common hues. It is a native of Madagascar, and was introduced to this country about 1818. The conservatories of Mr. Masters furnished us with many more rare plants, which our limits will not allow us to particularise. (*Canterbury Journal*, Sept. 14.)

*Wingham Horticultural and Floral Society.*—May 31. See *Gard. Gaz.*, 1839, p. 380.—July 26. *Ibid.*, p. 500.—Sept. 20. *Ibid.*, p. 645.

*Faversham Horticultural and Floral Society.*—June 27. See *Ibid.*, p. 448.

*Cranbrook and Weald of Kent Horticultural Society.*—June 25. See *Ibid.*, p. 456.

*Maidstone Horticultural Society.*—July 3. See *Ibid.*, p. 484.

*Tunbridge Wells Horticultural Show.*—Spring show. See *Ibid.*, p. 352.—July 12. *Ibid.*, p. 520.

LANCASHIRE.—*Chorley Horticultural Show.*—Sept. 29. 1838. See *Ibid.*, 1838, p. 836.

*Lancaster Horticultural Society.*—May 24. The committee have reduced the price of admission to the shows from 1s. to 6d., and thereby have insured a much larger attendance of visitors, and consequent good, than ever were before known. (*Lancaster Guardian*, May 25.)

*Manchester Botanical and Horticultural Society.*—April 29. See *Gard. Gaz.*, 1839, p. 282.—May 27. *Ibid.*, p. 364.

*Everton and Kirkdale Floral and Horticultural Society.*—Spring show. See *Ibid.*, p. 397.

*Denton Tulip Show.*—June 1. See *Ibid.*, p. 412.

*Hooley Hill Society of Florists.*—June 8. See *Ibid.*, p. 427.

*Bolton Floral and Horticultural Exhibition.*—July 5. See *Ibid.*, p. 453. and 501.

*Manchester Zoological Gardens Floral Exhibition.*—Summer show. See *Ibid.*, p. 484.

*Warrington Dahlia Show.*—Sept. 26. See *Ibid.*, p. 661.

LEICESTERSHIRE.—*The Loughborough Horticultural Society.*—Oct. 1. The flowers, green-house plants, fruits, and vegetables were excellent, and the dahlias far superior to those shown on any former occasion. (*Nottingham Review*, Oct. 4.)

*Thurleston and Newborough Floral and Horticultural Society.*—Principally set on foot for the encouragement of industrious cottagers. See *Gard. Gaz.*, 1839, p. 76.

*Leicester Floral and Horticultural Society.*—May 29. See *Ibid.*, p. 396.

LINCOLNSHIRE.—*Grantham Floral and Horticultural Society.*—Sept. 21. 1838. See *Ibid.*, 1838, p. 835.

MIDDLESEX.—*South London Horticultural Society.*—April 18. See *Ibid.*, p. 251.

*Metropolitan Society of Florists.*—April 24. See *Ibid.*, p. 266.

*Kentish Town and North London Floral Society.*—Aug. 21. 1838. See *Ibid.*, p. 62.—Oct. 1. *Ibid.*, p. 693.

*Hampstead Florists' Society.*—June 11. See *Ibid.*, p. 412.

*Highgate Horticultural Society.*—April 30. See *Ibid.*, p. 282.—June 19. *Ibid.*, p. 427.

*Uxbridge Horticultural and Floricultural Society.*—July 1. See *Ibid.*, p. 444.—July 29. *Ibid.*, p. 518.—Sept. 6. *Ibid.*, p. 611.

*Hampton Tulip Show.*—See *Ibid.*, p. 352.

NORFOLK.—*The Norwich Horticultural Society.*—April 24. In many respects the cottagers' table exhibited productions superior to those of the

more opulent contributors, an omen of the utility of the Society, which induces us to say to these industrious persons, "Go on and prosper;" for we have ever looked to the establishment of this Institution more as an incitement to the lower and middle classes, whose labour and attention are the principal portion of the wealth they can afford to bestow upon their gardens, than as a stimulus to the gardeners of those of the affluent whose means are ample, whose patronage and whose reward is the approbation of their employers. And while we are upon this subject, we cannot avoid alluding to our recommendations inserted in the latter part of last year. To excite the love of pecuniary gain was never the intention of those who instituted the Society, but that kind of emulation which leads to improvement, and to stimulate it by fitting rewards, which should be honourable. If it be urged that the medals (a set being once obtained) are of no value, the objection is met at once by the third new rule, which enables the member to allow his prizes to accumulate to the end of the season, when he may receive a piece of plate of their aggregate value. (*Norwich Mercury*, April 27.)

July 3. See *Gard. Gaz.*, 1839, p. 453.

*East Dereham Horticultural Society*.—A splendid display, which can scarcely be said to have been equalled at any previous show. (*Norwich Mercury*, April 27.)

NORTHAMPTONSHIRE.—*Northampton New Horticultural Society*.—See *Gard. Gaz.*, 1838, p. 702.

NORTHUMBERLAND.—*Botanical and Horticultural Society*.—July 5. The profusion of fine, good, old-fashioned stock gillyflowers showed that these flowers can successfully compete with many of the newer accessions to the flower-garden. (*Newcastle Courant*, July 12.)

*Felton Florists' Society*.—July 1. It having been discovered that one of the successful pansy competitors had exhibited flowers which he only obtained from a neighbour on the preceding day, thus setting at defiance the fourth rule of the Society, which states that "no member shall be allowed to show flowers which he has not had in his possession at least three months previous to the show," at a subsequent meeting, as this is the second offence, he was expelled for ever from the Society. (*Ibid.*)

Sept. 30. See *Gard. Gaz.*, 1839, p. 676.

NOTTINGHAMSHIRE.—*Chilwell and Beeston Floral and Horticultural Society*.—May 7. See *Ibid.*, p. 380.

*Chilwell and Beeston Florists' Society*.—Spring show. See *Ibid.*, p. 428.—June show. *Ibid.*, p. 454.

OXFORD.—*Henley Horticultural Show*.—Sept. 18. 1838. See *Ibid.*, 1838, p. 701.

*Oxfordshire Horticultural Society*.—May 23. 1838. See *Ibid.*, p. 349.

June 11. Under the very able management of the Professor of Botany, who is quite an enthusiast in the science, these gardens have been brought to the highest perfection, and form one of the most delightful promenades that could be desired. The Professor is entitled to the thanks of all, for affording the company the opportunity of revelling among some of the finest of nature's productions. The cottagers' articles were very respectable, and we have no doubt that many more will exert themselves, so as to merit the praise and rewards so liberally bestowed on the successful competitors. (*University Herald*, June 15.)

July 18. See *Gard. Gaz.*, 1839, p. 452. and p. 500.—Aug. 1. See *Ibid.*, p. 547.—Sept. 27. See *Ibid.*, p. 661.

*English Agricultural Society*.—July 16. See *Ibid.*, p. 449.

*Deddington Annual Show*.—Sept. 17. See *Ibid.*, p. 676.

SHROPSHIRE.—*Newport Horticultural and Floral Society*.—Sept. 13. 1838. See *Ibid.*, 1838, p. 701.

*Salop Horticultural Society*.—Spring show. See *Ibid.*, 1839, p. 352.—Summer show. *Ibid.*, p. 454.—Aug. 15. *Ibid.*, p. 561.

- Market Drayton Horticultural and Floral Society.* — Auricula show. See *Ibid.*, p. 352. — July 4. *Ibid.*, p. 500.
- Shrewsbury Union Florists' Society.* — July 8. See *Ibid.*, p. 456.
- SOMERSETSHIRE. — *Sherborne and Yeovil Horticultural Society.* — Autumn show, 1838. See *Ibid.*, 1838, p. 837.
- Bath Royal Horticultural and Botanical Society.* — Nov. 29. 1838. See *Ibid.*, 1839, p. 91. — April 25. 1839. See *Ibid.*, p. 348.
- Weston Geranium Show.* — June 20. See *Ibid.*, 1839, p. 456.
- Bristol Horticultural Show.* — Summer show. See *Ibid.*, p. 456.
- Old Down Pink Feast.* — July 2. See *Ibid.*, p. 456.
- Bathwick Pink Feast.* — July 9. See *Ibid.*, p. 456.
- Bristol and Clifton Amateur Dahlia Society.* — Sept. 5. See *Ibid.*, p. 660.
- STAFFORDSHIRE. — *Uttoxeter Horticultural and Floral Society.* — Autumn show, 1838. See *Ibid.*, 1838, p. 838.
- The Wolverhampton Florists' Society.* — Sept. 25. 1838. See *Ibid.*, 1839, p. 76. — May 25. 1839. See *Ibid.*, p. 381.
- Burton on Trent Horticultural Society.* — May 25. See *Ibid.*, p. 384.
- Stafford Floral and Horticultural Society.* — Spring show. See *Ibid.*, p. 384.
- Lichfield Floral and Horticultural Society.* — Spring show. See *Ibid.*, p. 365. — July 9. *Ibid.*, p. 455.
- Tamworth Horticultural Society.* — July 3. See *Ibid.*, p. 456.
- Wolverhampton Dahlia Show.* — Sept. 17. See *Ibid.*, p. 661.
- SUFFOLK. — *Stowmarket Horticultural Society.* — Sept. 14. 1838. See *Ibid.*, 1838, p. 702.
- Ipswich Horticultural Society.* — July 19. See *Ibid.*, 1839, p. 536. — Sept. 13. *Ibid.*, p. 611.
- Ipswich Floral Meeting.* — Aug. 2. See *Ibid.*, p. 536.
- SURREY. — *Wallington Grand Dahlia Show.* — Sept. 20. 1838. See *Ibid.*, 1839, p. 76.
- The Dorking Horticultural Show.* — June 1. See *Ibid.*, p. 412.
- Wallington Pink Show.* — July 3. See *Ibid.*, p. 677.
- SUSSEX. — *Chichester Horticultural Society.* — Oct. 2. 1838. See *Ibid.*, 1838, p. 837.
- Battle and Hastings Horticultural Society.* — July 11. See *Ibid.*, 1839, p. 456.
- Hurstperpoint Horticultural Show.* — Annual show. See *Ibid.*, p. 600.
- WARWICKSHIRE. — *Birmingham Botanical and Horticultural Society.* — April 18. Most of the plants exhibited were of a superior-grown quality, particularly those produced by W. C. Alston, Esq., John Willmore, Esq., Edwin Bullock, Esq., Mr. F. Dickenson, and Mrs. Willmore of Stawberry Vale. (*Birmingham Gazette*, April 20.)
- Warwickshire Floral and Horticultural Society.* — May 23. and 24. See *Gard. Gaz.*, 1839, p. 381. — June 5. *Ibid.*, p. 412. — August 29. *Ibid.*, p. 584.
- Coventry and Warwickshire Horticultural and Floral Society.* — July 9. See *Ibid.*, p. 485.
- Birmingham Grand Dahlia Show.* — Sept. 11. and 12. See *Ibid.*, p. 644.
- WILTSHIRE. — *Salisbury Plain Dahlia Exhibition.* — See *Ibid.*, 1838, p. 701.
- Chippenham Dahlia Show.* — Oct. 13. 1838. See *Ibid.*, 1838, p. 702.
- The Wilts Horticultural Society.* — The different exhibitions displayed the usual excellence and variety in the articles; and the cottagers' productions possessed greater merit than on any former occasion. Mr. Squibb of the Fisherton Nursery exhibited, on Sept. 8., one hundred species of Cacti, and extensive assortments of calceolarias and dahlias. (*Salisbury and Wiltshire Herald*.)
- Salisbury Royal Dahlia Society.* — Sept. 24. Owing to the spirited exertions of a few dahlia-growers in this city, the fame of Salisbury flowers has been extended from London to the metropolis of the West, and our columns have frequently, of late, borne witness to the success of our local cultivators in their competition for floral honours. Under these circumstances, an exhibi-



tion of no ordinary character was anticipated; especially as the very liberal scale on which the prize list was formed could not fail to induce distant growers to enter the field of competition. The result fully justified such anticipation; and it was generally admitted that the blooms on the present occasion were very superior to those exhibited at the previous year's show. The seedlings sent in for competition were very numerous, owing, in a great measure, to the elegant salver presented by Harry Biggs, Esq., for the first prize in this class. This piece of plate had the following inscription neatly engraved on it:—"Presented to the Salisbury and West of England Royal Dahlia Society, by the President, for the best Seedling Dahlia raised in 1838." At the south end of the council chamber appeared a magnificent device, composed of upwards of 5000 dahlia flowers, the work of Messrs. Keynes. Beneath the national arms, surrounded by the motto of the garter, appeared the name of our gracious sovereign; and under this, on a superb scroll, was the name of the patroness of the Society, Queen Adelaide. The manner in which the letters forming these illustrious names were fashioned, and shaded by darker flowers, was highly creditable to the taste and ability of the parties who formed the device. Above the garter was a crown and banners, &c., on two of which were inscribed the names of the Countesses of Pembroke and Radnor, the vice-patronesses of the Society. No other material but the flowers of the dahlia was used in this unrivalled *tableau*, which was 18 ft. in height. In another part of the room appeared a large and splendid representation of the arms of the city, also composed wholly of dahlia blooms. The supporters, formed of bright yellow flowers, were very effective. Mr. Godwin of High Street constructed this latter device. (*Ibid.*, Sept. 29.)

*Calne Horticultural Society.*—Sept. 12. 1838. See *Gard. Gaz.*, 1839, p. 62.

WORCESTERSHIRE.—*Worcestershire Horticultural Society.*—Spring show, and May 29. See *Ibid.*, p. 381.—July 17. *Ibid.*, p. 453.—July 23. *Ibid.*, p. 501.

YORKSHIRE.—*West Riding Horticultural Show.*—Sept. 5. 1838. See *Ibid.*, 1838, p. 733.

*Keighly Dahlia Show.*—Sept. 19. 1838. See *Ibid.*, p. 835.

*Liversedge Horticultural and Floral Society.*—Sept. 21. 1838. See *Ibid.*, p. 836.

*Malton Horticultural Show.*—Oct. 2. See *Ibid.*, p. 838.

*Rotherham Society of Florists and Amateurs.*—Oct. 5. 1838. See *Ibid.*, p. 836.

*The North Riding Horticultural and Floricultural Society.*—Sept. 27. The fruits and vegetables were of the very first order, and the display of dahlias, above 1200 in number, beautiful beyond description. There was great competition for the prizes granted by the Earl of Tyrconnel and the Society to industrious cottagers, and the vegetables exhibited by them were certainly of the finest sort. (*York Herald*, Oct. 5.)

*Sheffield Bazaar Florists' Society.*—Oct. 9. 1838. See *Gard. Gaz.*, 1839, p. 76.

*Leeds Horticultural Society.*—For the carnation and picotee show for 1838, see *Ibid.*, p. 76.

*Retford and Bawtry Horticultural Society.*—May 7. See *Ibid.*, p. 298.—May 14. *Ibid.*, p. 330.—Oct. 4. *Ibid.*, p. 677.

*Sheffield Horticultural Society.*—May 16. See *Ibid.*, p. 331.—June exhibition. *Ibid.*, p. 452.

*Hull Floral and Horticultural Show.*—Spring show. See *Ibid.*, p. 365.—Aug. 15. *Ibid.*, p. 546.

*York Horticultural Society.*—Spring show. See *Ibid.*, p. 365.—June 26. *Ibid.*, p. 428.—Aug. 20. *Ibid.*, p. 562.

*Ripon Florists' Society.*—Spring show. See *Ibid.*, p. 397.—June show. *Ibid.*, p. 600.

*Doncaster Horticultural Show.*—Summer show. See *Ibid.*, p. 455.

*Whitby Horticultural Society.*—July 23. See *Ibid.*, p. 562.

*Yorkshire Grand Horticultural Fête.* — Autumn show. See *Ibid.*, p. 600.  
*York Amateur Florists' Society.* — Ranunculus show. See *Ibid.*, p. 600.  
*Hemsworth Horticultural Exhibition.* — Sept. 5. See *Ibid.*, p. 611.

## WALES.

DENBIGHSHIRE. — *Wrexham Horticultural Society.* — Summer show. See *Ibid.*, p. 501. — Sept. 24. *Ibid.*, p. 660.

## CHANNEL ISLANDS.

JERSEY. — *Jersey Agricultural and Horticultural Society.* — The exhibitions of fruits, flowers, vegetables, and poultry were equal to those of former years. Many prizes were awarded, and the ticket "worthy of commendation" was affixed to numerous specimens of fruits, flowers, and vegetables. (*Jersey Times.*)

GUERNSEY. — *Guernsey Horticultural Society.* — May 15. The cottagers' tables were laid out with the productions usually displayed by that industrious class, and were considerably superior, notwithstanding the unfavourable influence of a cold and changeable season. It was pleasing to see the very numerous and creditable contributions from the cottagers' gardens. The zeal and perseverance which have been excited in the culture of vegetables were plainly to be observed on viewing the display sent for competition on this day. (*Star*, May 16.)

Sept. 12. We insert the following, in order to give other societies an idea of what the cottagers of Guernsey are expected to have in their gardens.

*Cottagers' Prizes. Mr. Vidamour's Medal.* There having appeared no competitors for this medal at the last July show, Mr. Vidamour offers it again to the cottagers, if they wish to compete for it at the next July show, for the same articles, viz.: — Best 100 pods green peas; best 100 pods French beans; best 25 pods large beans; best 3 cauliflowers; best 3 cabbages; best 3 lettuces; best plate morello cherries, not less than  $\frac{1}{2}$  lb.; best plate white raspberries, not less than  $\frac{1}{2}$  lb.; best plate red ditto, ditto; best plate red gooseberries, ditto; best plate gooseberries, white or green, ditto; best plate red currants, ditto. N.B. The best of any kind. — Those to be considered cottagers who are inhabitants, and not rated above thirty quarters.

*Flowers.* 5s. for the best bouquet; 2s. 6d. second best ditto; 1s. 6d. third best ditto; 2s. best dahlia; 1s. 6d. second best ditto; 3s. best show of dahlias; 2s. second best ditto; 2s. best German asters; 1s. 6d. second best ditto.

*Fruits.* 3s. Best show of apples; 2s. 6d. second best ditto; 2s. third best ditto; 2s. best six apples, Ribston pippin; 2s. best six old nonpareil; 2s. best six old golden pippin; 2s. best six pearmain; 2s. best six aromatic russet; 2s. best six Mollett's golden pippin; 2s. best six reinette franche; 2s. best six lemon apple; 2s. best six grise reinette; 2s. best six Hawthornden; 5s. best six Chaumontel pears; 3s. second best ditto; 3s. best show of pears, at least six sorts, three of each; 2s. second best ditto, ditto; 2s. best six pears, beurré d'Aremberg; 2s. best six beurré d'Amanlis; 2s. best six passe-Colmar; 2s. best six Louise bonne; 2s. best six white doynné, or St. Michael; 2s. best six belle et bonne; 2s. 6d. best six plums; 2s. best bunch of white or yellow grapes, grown in the open air; 1s. 6d. second best ditto, ditto; 2s. best bunch of black or purple grapes, ditto; 1s. 6d. second best ditto, ditto; 2s. best plate medlars.

*Vegetables.* 2s. Best six white onions; 2s. best six red ditto; 2s. 6d. best plate white, red, and blue potatoes; 2s. second best ditto; 2s. best three roots white celery; 2s. best three roots red ditto; 2s. 6d. best plate green peas; 2s. 6d. best plate French beans; 2s. best six parsneps; 2s. best six turnips; 2s. best small round ditto; 2s. best six carrots; 2s. best three cauliflowers; 2s. best three cabbages; 1s. 6d. second best ditto; 2s. best three red cabbages; 2s. best three Savoy ditto; 2s. best three broccoli; 2s. best three cabbage lettuce; 2s. best three heads curled endive; 2s. best three Batavian ditto; 2s. best six tomatoes; 3s. best glass of honey. (*Ibid.*, Sept. 12.)

Sept. 29. This was one of the best shows this year; and, as individual specimens, the gems of the day were decidedly Mr. Hooper's (nurseryman) *Salvia patens grandiflora*, in fine bloom, which attracted general notice, and Mrs. Du Feu's *Fuchsia fulgens*, about 3 ft. in height, and perhaps as fine a plant of it as was ever shown, the magnificent foliage, quite perfect, feathering down to the pot, and the whole crowned with a fine truss of blossom; the lower leaves were 9 in. in length, and of proportionate width. The cottagers' productions were a subject of surprise and admiration to all who examined them; in very many cases they surpassed what was produced from gentlemen's gardens; and the number of competitors in this class is becoming so numerous, that, in order to do justice, the judges were forced to award nearly twenty extra prizes, besides the fifty which were advertised by the Society, and which were almost all competed for. In this way about eight pounds sterling were distributed. (*Ibid.*, Oct. 4.)

### SCOTLAND.

*The Caledonian Horticultural Society.* — The exhibitions this year have maintained their usual excellence. Specimens of fruit were not numerous, but they were of very superior quality, especially the peaches. The silver medal was voted to Mr. George Shiells, gardener to Lord Biantyre, Erskine House, for magnificent specimens of the new galande and George the Fourth peaches, each of the former weighing eight ounces imperial. It is believed that larger or higher-flavoured fruit than these were never produced at the celebrated peach gardens at Montreuil. [A plan and description of the kitchen-garden and hot-walls at Erskine House, furnished to us by Mr. Shiells, will be found in a former volume. It is remarkable that, in a climate at all times unfavourable for the ripening of fruit, and in a season more than usually unpropitious, Mr. Shiells should have been so singularly successful. Even in England, this year, peaches and nectarines are deficient in flavour. We should be glad to hear from Mr. Shiells on this subject; for, no doubt, he can assign some reason for his success.] The articles sent by nurserymen, on this occasion, were marked "not for competition." It would be unpardonable to omit to mention the noble orange trees, and splendid *Ericæ*, from the Royal Botanic Garden; together with two most magnificent fuchsias, *F. grandiflora* Youngii, 10 ft. high, and *F. recurvata*, 8 ft. high, both covered with their pendent scarlet blossoms. The Society's garden likewise supplied several specimens, remarkable for their rarity or beauty, particularly *Banksia speciosa* in flower, *Maurandya Laceyana*, and pots of mixed species and varieties of *Verbena*, fan-trained, and having their various-coloured blossoms intermingled. (*Caledonian Mercury*, July 18.)

Sept. 5. The display of fruits at the anniversary festival was much greater than could have been anticipated from the backward and ungenial weather which has prevailed. The quality of the open wall fruit has certainly been excelled on former occasions, but grapes, pine-apples, and melons were never finer. After dinner, the chairman, W. Gibson Craig, Esq., M.P., said, in proposing as a toast the Royal Caledonian Horticultural Society, he felt it unnecessary to dwell at any length on its merits; it was sufficient to point to the exhibition which was now before the meeting. The Society had been eminently instrumental in advancing the science of horticulture by means of its publications, by the care it had taken in the introduction of various kinds of fruit, by the stimulus it had given to the enterprise of gardeners, following the example of another Society which had in a most eminent degree advanced the agricultural prosperity of this country. Such an institution as this had been established with peculiar propriety in Scotland; because, high in literature and science as this land might be rated, yet it could not in these respects boast a preeminence over other lands; but, in horticulture, Scotland stood without a rival. In every country Scottish gardeners maintained the superiority, and it was incumbent on the Society to furnish information to that class of individuals who had, in this department, so highly raised the name

of their native country in every quarter of the civilised world. The care of the Society was bestowed not only on fruits, on those productions which were fitted to pamper the tastes of the luxurious; they attended not less sedulously to the rearing of those common productions which were calculated to benefit the country at large. The affairs of the Society were in the most flourishing condition, and he hoped that the support of the public would henceforth be given to it in a greater degree than ever, for such an institution was a national benefit.—The Lord Provost proposed the health of the chairman, whose courteousness of manner, and kindness of disposition had, he said, secured the esteem of all who had come in contact with Mr. Craig.—The Chairman returned thanks, and proposed the health of that most valuable member of the Society, their excellent secretary. (Great cheering.) The toast was drunk with all the honours, and one cheer more. Dr. Neill, in returning thanks, said, if he had served the Society long, it had been a pleasure, not a toil; and he could not form a better wish for the happiness of all who heard him, than that they might all enjoy as much felicity from horticulture, and the Horticultural Society, as he had enjoyed. He was now one of four surviving original constituent members; the other three being Dr. Home, Mr. Macdonald, formerly of Dalkeith, now of Portobello, who had assisted at the competition yesterday, for four or five hours, and Mr. Walter Sang, sen., of Kirkaldy, whom he was happy to see this evening acting as croupier. Through the late Mr. Kennedy and the Lord Advocate, they had received a grant of 200*l.*, to be continued annually, provided the Society raised 300*l.*; and he had no doubt they would do more. He begged to propose “The professional gardeners of Scotland; may they long continue to maintain their distinguished name for superiority of professional talent and correctness of moral character.” Drank with all the honours.—Mr. Sang returned thanks. (*Edinburgh Evening Courant*, Sept. 7.)

*The Caledonian Gardeners' Society.*—The annual competition and dinner took place in the Calton Convening Rooms, July 16. After dinner, the chairman, Charles Lawson, Esq., President of the Society, presented the Society with a handsomely silver-mounted ram's-horn snuff-mull, with all the Highland appendages, having a large Cairngorm on the lid, and on the tip a thistle, ornamented by a beautiful amethyst. (*Caledonian Mercury*, July 18.)

*The Highland and Agricultural Society of Scotland* held their half-yearly general meeting at their hall, in Edinburgh, July 8; and their annual show of live stock was held at Inverness, on October 3. (*Constitutional*, July 13.; and our p. 626.)

ABERDEENSHIRE.—*Aberdeenshire Horticultural Society.*—The fourth exhibition of the Society, held on September 3., is said to have been the best ever seen in Aberdeen. One of the prizes was for a beautiful new seedling *Fuchsia*, raised by Mr. Alexander Forbes, Kingsland Place. (*Aberdeen Herald*, Sept. 7.)

*Aberdeenshire Horticultural Association.*—This Society holds its exhibitions monthly, and to it the city of Aberdeen is said to be “indebted for its rich and rare supply of fruits and vegetables.” An extra prize was awarded to John Booth, gardener, Canal Road, for a splendid *Fuchsia*, raised from seed by him; and two extra prizes to Patrick Grant, Thainston; the first for a box of calceolarias, and the second for a strawberry, also raised from seed by him; a fine-looking fruit, and a good bearer. There was also presented a fine box of geraniums, from the garden of Thainston. This institution contemplates a botanic garden. (*Aberdeen Journal*, July 31.)

AYRSHIRE.—*The Ayrshire Horticultural and Agricultural Association* continues to prosper.—*May* 31. See *Gard. Gaz.*, 1839, p. 397.

At the September meeting, a very neat model of a thrashing-machine, to be worked by the hand, made by Mr. Henderson, Thornhill, attracted attention, from its simplicity and apparent practicability. It would require no more than two men to work it, and could be constructed for a sum comparatively trifling. Mr. Henderson is well known as a self-taught and most ingenious

mechanic; one or two curious specimens of his handicraft are deposited in the Ayr Mechanics' Museum. (*Ayr Observer*, Sept. 24.)

*Kilmarnock Horticultural Exhibition.* — May 31. See *Gard. Gaz.*, 1839, p. 397.

CLACKMANNANSHIRE. — *The Clackmannanshire Horticultural Society* has had several good exhibitions; but the names of the plants exhibited are sadly spelt in the newspaper reports. [Were the editors of newspapers to procure our *Hortus Britannicus*, or Steudel's *Nomenclator Botanicus*, and consult either of these works as a dictionary, they would be able to spell correctly every botanic name that could occur.] Several fine specimens of ornamented flower-pots were exhibited by Mr. Bald of the Brick and Tile Works; all of which were much admired. (*Stirling Journal*, May 10.; *Stirling Observer*, May 16.)

July 4. Several fine plants were exhibited without even the names, which could very easily have been affixed to them by any of the junior gardeners, and which would have contributed much to the gratification, and even the instruction of many, especially the juvenile visitors. Mr. Miller, surgeon in Alloa, exhibited a *Hortus Siccus Floræ Clackmannensis*, vol. i., in large folio, very neatly arranged; the work, altogether, being very creditable to that young gentleman's industry and research. Mr. Andrew Cargill exhibited a singular walking-staff, consisting, like one he formerly brought forward, of three pieces in the centre, but united at each end, highly polished, mounted with silver at the upper end, and well shod with brass and steel. (*Stirling Advertiser*, July 12.)

Sept. 12. Notwithstanding the unfavourable weather, the display of fruits, flowers, and vegetables was particularly good, and appeared to give much satisfaction. (*Ibid.*, Sept. 27.)

DUMFRIESSHIRE. — *The Dumfriesshire and Galloway Horticultural Society*, one of the oldest in Scotland, continues to flourish, being warmly patronised by the Duke of Buccleugh, and most of the proprietors in the South of Scotland. At the September meeting an extra prize was awarded to Mr. L. Robertson, butler at Craigiellands, for an ornamental temple composed of flowers; and one for a bouquet of flowers dressed upon deer's horns, to Mr. James Anderson. (*Dumfries Courier*, Sept. 25.)

*The Upper Annandale Horticultural Society* held its second meeting at Moffat, on Sept. 13. Premiums were given for a splendid collection of 800 dried plants, by Mr. James Dawson, under gardener, Craigiellands. James Anderson, Hartfield Tower, a fine collection of 700 dried plants, beautifully preserved. Best bouquet, James Henderson, Moffat. Best design of a bouquet, model of Moffat Gas-work in flowers, Robert Hamilton, Moffat. The Johnstone medal to Mr. John Henderson, Heathryhaugh, for a model of a pavilion.

Extra Prizes offered by Mrs. Hope Johnstone. — Best skep of honey: 1st, Mr. Marchbank, Beattock; 2d, James Hastie, Marchbank Wood. The best-kept cottage and garden not yet decided, but will be duly notified. Splendid ornamental bouquet, extra: 1st, Mr. Robertson, butler to William Younger, Esq. of Craigiellands, being a model of St. Paul's, London; an excellent design, and beautifully executed, with a first-rate *salad* within the dome, which was served up at the dinner, and certainly afforded no common treat; 2d, a very handsome bouquet, by Mr. Clark, gardener, Raehills. A splendid specimen of a Scotch thistle, 7 feet high, by Mr. John Fisher. Mr. William Drummond, Eliza Town, exhibited a gigantic garden turnip, 30 inches in circumference. A beautifully dressed letter A, by Miss Allan of Craigiellands. An excellent specimen of seedling potatoes, from plums of 1838, produced by Mr. Murray, Gardenholm, was inadvertently neglected to be put on the table, otherwise it would have gained a prize. (*Ibid.*)

*Glenkens Society.* — Aug. 14. See *Gard. Gaz.*, 1839, p. 547.

EDINBURGHSHIRE. — *The Mid-Lothian Horticultural Society* held its several exhibitions in the Assembly Rooms, Dalkeith, and awarded various prizes. We have not observed the name of Mr. MacIntosh, the Duke of

Buccleugh's gardener at Dalkeith, as contributing either to this Society or the Caledonian Horticultural Society, at which we are rather surprised, considering that His Grace warmly patronises the Dumfries Horticultural Society. (*Caledonian Mercury*, July 14.)

FIFESHIRE. — *The St. Andrews Horticultural and Floricultural Society.* — In toiling through the mass of sameness which such a summary as the present must necessarily be, our readers will find some relief to peruse the following very gratifying account. The fourth and last meeting for the season took place in the Town-Hall, on Wednesday, the 25th September, and was most respectably and numerously attended by the ladies and gentlemen of the city and neighbourhood. Our worthy patron and patroness, Sir David and Lady Erskine, attended to take leave of the Society, on their removing to a distant part of the kingdom for some years, on account of the precarious state of Sir David's health. They both sincerely expressed their goodwill towards the Society, and hoped that it would continue to prosper and improve the Horticulture and Floriculture of this quarter of the country, as it manifestly has done to a very great extent; and that every gentleman having a piece of ground worthy of the name of garden, would see it to be his interest and duty to become a contributor to it; and that every gardener who wishes to excel, or keep pace with the advance of the science, would regularly attend its meetings, for otherwise he is neglecting his own practical improvement, and his master's interests. The exhibition was extensive in every department, and, as a whole, was a most inviting and interesting scene. The members, with one voice, re-elected Sir David and Lady Erskine as their patron and patroness. After the exhibition closed, the members dined together in the Cross Keys Inn, having fixed on this day for presenting Mr. Smith [our correspondent], their secretary, with a handsome German silver teapot, cream jug, and sugar basin. After the usual loyal and patriotic toasts were given, Mr. George Cruikshank, the chairman, called for a bumper to the secretary's health. He said : — " Mr. Smith, Sir, I have the honour of being deputed by this Society to convey to you the respect and esteem they entertain for your moral character, your professional attainments, but more particularly the obligation they lie under to you for your long laborious services as their secretary. I wish they had chosen one better qualified to do justice to your merits; but truth needs no set phrase of speech. To your exertions, Sir, we are chiefly indebted for this Society's formation, its constitution; and nearly ever since its establishment you have been its secretary, to the satisfaction of all its members. When we compare bygone times with the present, we are apt to think we once lived in darkness. We now live in a more advanced, a more improved, and in a more enlightened stage of society. Man was made to be a social being, and the Author of his being infused into his breast the milk of human kindness, to perform mutual offices of benevolence towards one another, and in forming societies like the present for our mutual improvement. A gardener, Sir, is a profession not beneath the dignity of a prince. If we trace its antiquity, we find it coeval with man. In cultivating a taste for plants, we are cultivating our own minds, and are led to give praise to that Infinite Being who has supplied us with such an endless variety of them. In your presence, Sir, I shall only state what I feel strictly my duty to do, that your mild and unassuming manners, your willingness at all times to communicate information, combined with a strict integrity in the cause of truth and duty, as secretary of this Society, call forth this public expression of our feeling, that you are an ornament to the profession to which you belong, as well as an intelligent and pleasing companion. I now present you, Sir, with this token of our respect and esteem for your long valuable services as secretary of this Society, and may you and your family long live to use them."

Inscription : — " Presented to Mr. William Smith, gardener, by the St. Andrews Horticultural Society, in token of respect for his services as their Secretary. 1839."

After the immense burst of applause had subsided, Mr. Smith rose and said :—" Mr. Chairman and Gentlemen, My feelings on this occasion are wound up to the highest pitch, so that I can scarcely contain them. I shall pass over this high eulogium on my character and services, which has just been delivered in your presence, and merely say, that by this most splendid gift, which has been most ably and most handsomely presented to me by my friend Mr. Cruikshank, you have conveyed to me in a solid and substantial manner the feelings which the members of the St. Andrews Horticultural Society entertain toward me in the capacity of their practical secretary. According to the best of my abilities, I have uniformly endeavoured to discharge the duties of my office ; but such a mark — such a distinguished mark — such a public mark — such a valuable mark — of your approval of my humble services I had not the smallest reason to expect. It is, therefore, with feelings of the deepest gratitude that I sincerely thank you for this public expression of respect towards me as your practical secretary. Yes, gentlemen, from the bottom of my heart I most humbly, most truly, and most sincerely thank you."

Among the subjects for which prizes were awarded, the following are worth notice :—William Smith, gardener to John Small, Esq., of the Priory, St. Andrews, best black Hamburg grapes ; best white Frontignan grapes ; best six apricots, viz. Moorpark ; best six jargonelle pears ; best six fuchsias, viz. F. fulgens, F. globosa erecta, F. virgata, F. globosa, F. Thomsoni, F. microphylla ; best six hardy annuals, viz. *Collinsia bicolor*, *Eutoca viscida*, *Nemophila insignis*, *Leptosiphon densiflorus*, *Lupinus nanus*, *Schizanthus pinnatus*. For the greatest number of prizes during the season, James Falconer. For the greatest number of amateur prizes during the season, Baillie Gibson. Best design, James Keddie, journeyman gardener, Cambo. This was a most delightful garden in miniature ; it contained every feature in the flower-garden ; and about twenty young fishes were swimming lively enough in the pond. Great praise was given to this fine piece of workmanship, and very justly, for a better specimen of the gardenesque we have not seen.

*Cottagers' Prizes.* Best six onions, Thomas Ramsay, weaver, Argyle Street, St. Andrews ; 2d do., David Scott, shoemaker, North Street, St. Andrews. Best six dahlias, William Bruce, Balcarres. There were shown to the Society from Thomas Wallace, Esq., two fine specimens of the Aberdeen yellow turnip. From Largo House, twelve splendid new dahlias, and six large fine peaches. From Mrs. David Berwick, St. Andrews, a very large and fine specimen of red cabbage. From Dr. Cook, two beet roots of the growth of 1838, in good preservation. (*Fifeshire Journal*, Oct. 3.)

The *Pitlessie Horticultural Society* hold quarterly meetings which are well attended, both by professional gardeners and amateurs, and we are happy to see that cottagers are properly encouraged. The meetings are held in the parish schoolroom. (*Fifeshire Journal*, Oct. 3.)

*The Cupar Horticultural Society.*— For the summer show, see *Gard. Gaz.*, 1839, p. 453.

*Sept. 27.* This meeting, we regret to say, was not accompanied with its usual gaiety or attractions. The unfavourableness and lateness of the season suited ill for the productions of the flower-garden, and still worse for those of the fruit trees. But more unfortunate than either of these is a spirit of apathy which unhappily has for some time past been extending itself over the members of the Society and their operations, and which has now attained, or rather, we should say, which we now hope has passed its height, and is about once more to depart. The attendance at the forenoon exhibition was indifferent enough, as, indeed, we fear there was little or no sufficient reason that it should have been otherwise. We know not well how this state of things has come around. Last year was most brilliant, and we have heard of no mischance or misadventure to have brought about the present crisis. Too much praise cannot be bestowed on those who, in the midst of disheartenment and indifference, continue to persevere, and will, we trust, yet be successful in revivifying the Society. Several prizes were awarded. (*Fifeshire Journal*, Oct. 3.)

*Fife*shire Horticultural and Floricultural Society. — May 8. See *Gard. Gaz.*, 1839, p. 331.

LANARKSHIRE. — *Glasgow Practical Florists' Club*. — Tulip show. See *Ibid.*, p. 454.

*Glasgow Horticultural Society*. — July 10. See *Ibid.*, p. 454.

KINCARDINESHIRE. — *Kilmadock and Kincardine in Monteith Cottage Garden Society*. — Sept. 21. The articles brought forward for competition and exhibition were of superior quality, and very much admired by the numerous and very respectable visitors who honoured the exhibition with their presence. It is very gratifying to observe the spirit and emulation evinced among the cottagers in this quarter, in the cultivation of their gardens and the cleanly manner in which their cottages are kept; and we feel assured that the establishment of this Society will be of general utility in promoting the improvement of cottages and gardens in the neighbourhood. (*Stirling Advertiser*, Sept. 27.)

MORAYSHIRE and NAIRNSHIRE. — *The Forres and Nairn Horticultural Society* has not been long established, but some of its late exhibitions have displayed a larger and richer collection of beautiful and splendid plants than had ever previously been seen together in that part of the north of Scotland. At the summer meeting of the Society, held June 28., the very large and choice collection of plants for exhibition from Dalvey was much admired; particularly the pelargoniums and calceolarias, which formed a brilliant mass of colour. There were among this collection several handsome varieties of *Alstræmèria*, and some beautiful heaths; a fine plant of *Rodochiton volùbilis*, and the elegant *Clématis Sieböldii*. Among the many plants from Brodie House, besides those for which premiums were awarded, were, a fine thriving plant of *Fúchsia fulgens*, and several of the newest and finest verbenas. A handsome new variety of *Mímulus*, from Knockomie, was particularly admired. The pansies, from Dumphail, Kilravock, Dalvey, Mr. Stark's, and the Forres Nurseries, were exceedingly fine, especially the seedlings. Mr. Gillan exhibited, from his collection in Forres, several *Cácti* in fine flower, also a cherry tree covered with ripe fruit; Dr. Brands, a handsome plant of *Mímulus glutinosus*, &c., and some well-grown fuchsias; and there were several good specimens of stocks from the gardens of Forres. In short, the gardeners and amateurs of the district vied with each other to render this exhibition as attractive and interesting as science, taste, and expense could render it. The vegetable productions exhibited, notwithstanding the backwardness of the season, surpassed all that was anticipated. The cauliflowers, peas, potatoes, turnips, &c., were excellent, and the cucumbers uncommonly fine; one from Geddes measured 20 in. in length. (*Forres Gazette*, July 3.)

PERTHSHIRE. — *The Royal Horticultural Society of Perthshire*, as usual, goes on well. At the anniversary meeting, Sept. 6., the exhibition afforded the most gratifying evidence of the perfection to which horticulture is brought in this county. The grapes, both as regards the richness of the clusters and the size of the berries, were the finest ever exhibited here; the latter characteristic was particularly observable in the specimens from Scone Gardens. (*Edinburgh Evening Courant*, Sept. 7., and *Perth Courier*, Sept. 26.)

RENFREWSHIRE. — *Paisley Floral and Horticultural Society*. — July 11. See *Gard. Gaz.*, 1839, p. 456.

STIRLINGSHIRE. — *Stirling Horticultural Society*. — May 7. The display was good, and the premiums awarded numerous. We observed with much satisfaction that several of the lots were very correctly and plainly named, as suggested by the rules of the Society, a practice which we should like to see quite general; as the circumstance of having every specimen named tends to diffuse the kind of information sought after by the majority of the visitors. This is, no doubt, a little labour on the part of the cultivators; but it could be managed, in most cases, by the young men (assisted by books of reference, to which they have access) at spare hours, previously to each show, an exercise which, we are sure, will prove most profitable to themselves. (*Stirling Observer*, May 16.)



July 9. An ornamental bouquet, upwards of 11 ft. in height. Flowered stalk of Siberian cow-parsnep, from a spreading plant about 9 ft. high; also garden chairs. (*Stirling Advertiser*, July 12.)

*Aitken's Horticultural Show at Falkirk.* — July 11. The numerous tenantry who are fortunate enough to possess the splendid garden grounds which adorn the south of Falkirk, the property of Thomas Aitken, Esq., of Dorrator, had their fifth annual competition. The vegetables which were exhibited showed a degree of excellence which was much to the credit of the rearers, and afforded a pleasing proof of the success which a wise and good landlord can command when seconded in his exertions by the skill of such a body of tenants. In the evening, "an excellent dinner, appropriate toasts, and neat speeches." (*Ibid.*) [We should be glad if some correspondent would send us an account of the nature and origin of the garden grounds referred to in the above paragraph.]

*Falkirk Horticultural Society.* — Sept. 20. The fruits, although scarce, occasioned by the inclemency of the weather, were fine in quality. The vegetables were superb, and very abundant; and both did great credit to the competitors and exhibitors. Two very splendid and ornamental bouquets were exhibited by Messrs. Smith and Miller. The bouquet of the latter was in the form of a crown, standing on a pedestal, and was 7 ft. high, dressed wholly with dahlias, comprising not less than 2000 blooms, and was the object of unqualified admiration. The show, in the opinion of the first judges, was the finest, without exception, held in Scotland this season. (*Ibid.*, Sept. 27.)

#### IRELAND.

*Practical Floral and Horticultural Society of Ireland.* — Jan. 1. 1839. See *Gard. Gaz.*, 1839, p. 48.

BELFAST. — *The Northern Horticultural Society* held its usual shows, which, for the beauty and variety of the specimens produced, were not inferior to those of former years. The following is a specimen of the agricultural prizes given:—

April 12. Mangold wurzel (open to competition of farmers), for the best three roots; second do. Rye grass (sheaf 6 in. round), for the best; second do. Clover (sheaf 6 in. round), for the best. Vetches (sheaf 6 in. round), for the best. Rape, for the best three plants; second do. Turnips, for the best three Swedish of any sort; second do. Cottage gardens (for cottagers only); no competition in any of the classes of vegetables, flowers, or fruit. (*Northern Whig*, April 13.)

Summer show. See *Gard. Gaz.*, 1839, p. 453.

Sept. 13. Agricultural productions:— Mangold wurzel, for the best three roots. Field beans, for the best twelve stalks. Grey peas (sheaf 6 in. round), for the best. Vetches (sheaf 6 in. round), for the best. Rape, for the best three plants. Potatoes, for the best six (for feeding). Turnips, for the best three Swedish; for the best three Aberdeen; for the best three Dale's hybrid; for the best three Norfolk or Globe. Carrots (for feeding), for the best and largest eight.— Cottage gardens. Vegetables: for the best collection, Mr. Hugh Rea, Holywood. Flowers: for the best collection, Mr. Hugh Rea; second do., Mr. Wm. Darragh, Ballymacarrett. Fruits: for the best collection, Mr. Hugh Rea. [We regret to observe the small number of cottagers who come forward at any of the Irish horticultural exhibitions; and ardently wish to see greater exertions made, by the more influential members of horticultural societies in Ireland, to diffuse a knowledge of and taste for horticultural comforts among their poorer brethren.] (*Northern Whig*, Sept. 17.)

KILKENNY. — *Kilkenny Horticultural Society.* — Sept. 5. See *Gard. Gaz.*, 1839, p. 644.

WATERFORD. — *The Waterford Horticultural Society* held its spring show of fruits and flowers [no date], see *Gard. Gaz.*, 1839, p. 349., and the summer show on Aug. 21.; and the result appears to have been gratifying to the exhibitors and visitors, "a fashionable assemblage." (*Kilkenny Moderator*, August 28.)

ART. III. *The Arboriculture of the Voyage of Captains King and Fitzroy.* By Captain S. E. COOK, R.N.

THESE volumes are the result of one of the most extensive operations in nautical surveying which have taken place since the peace, during which period great and highly creditable exertions have been made by the naval administrations, to wipe off the stain of the extraordinary ignorance we were previously in respecting many portions of the globe (our own coasts and harbours not excepted), which are of the greatest consequence to our extended navigation.

It is impossible even to sketch the observations which were carried on upon almost every subject connected with, or in any way bearing upon, the main object of the survey, which reflect lasting honour on all engaged in them; and we shall confine ourselves to those on botany, more especially to those which relate to our favourite branch of arboriculture.

The survey embraced more particularly the Straits of Magalhaens and Tierra del Fuego, with the adjacent coasts on each side of the continent of South America, of which we knew little except from the accounts left by the earlier navigators.

The southern termination of the continent is by the submersion of the great cordillera of the Andes, which, before its final disappearance, displays a prodigious number of peaks and valleys, of every shape and dimension, forming a most interesting archipelago. Some of the higher points reach nearly 7000 ft. in elevation, and in one part leave a channel (named after the Beagle surveying vessel) of 120 miles in length, by one in average breadth, the coast line of which is so straight, that the eye takes in the whole length at one view; a circumstance, as far as we know, unique in the physical geography of the globe. The effect of this half-submerged chain on the climate and vegetation is very remarkable. The prevailing winds being from the Pacific, the vapours are arrested by the mountains, and precipitated in the shape of almost perpetual rain, making it, probably, the most humid region on the globe; whilst the eastern or Patagonian side, stretching towards the pampas of Buenos Ayres, is afflicted with an excess of drought, causing almost hopeless sterility, and resembling that of the deserts of Africa or the steppes of Asia.

The central part of this vast archipelago, the rocks of which are chiefly primary, is covered with a vegetation peculiar to itself, and forming forests so deep and luxuriant, that they are compared by Mr. Darwin to those of Brazil. The monarch of these woods is the beech, of which two sorts, the *F. betuloides* and *F. antarctica*, appear to form the principal mass. The former species is evergreen, though the foliage is described as of a dull rusty appearance, and it attains a large size; one tree having a trunk 20 ft. in circumference, carrying 17 ft. as high as 20 ft. and upwards, where it forms three branches of proportionate size. The wood was found to be useful for many purposes, though, as might have been foretold by any one acquainted with the genus, unfit for masts, for which use it was recommended by Byron. Most of the larger trees of this species were unsound at the heart, no doubt owing to the humidity of the subsoil; and it was necessary to bore into them with an auger previously to cutting them down, in order to prevent disappointment. The deciduous species (*F. antarctica*) is more hardy than the evergreen, but we hear less of the timber. In parts which are exposed to the almost ceaseless tempests which desolate this dreary region in every season of the year, these trees, especially the last-mentioned species, become so stunted, that their appearance must be very singular. One tree, near Cape Horn, is described as being only an inch in height, and spreading 4 or 5 feet along the ground. In many instances, in ascending the mountains to make observations, the foliage of these dwarf trees, mixed with shrubs, was so dense, that the party walked or crawled over the surface, to

pierce through being quite impracticable. The other associated species are, the *Wintera aromática*, the *Bérberis ilicifolia*, an arbutus, a fuchsia, the *Gúnnera integrifolia*, and *Cinerària leucánthema* of Banks & Solander, a ribes, cranberries, and a chamitis, which formed a verdant carpet, assisting them to pass the bogs, which, with the rocks, seem alternately to form the surface of this dismal country. In addition to these and some others, we have an arborescent veronica (*V. decussata*?) growing to 20 ft. in height, and with a stem 6 in. in diameter, which is so hardy that it resists the hurricanes (called by the Patagonian name of williwaw), where nothing else will grow.

Amongst other peculiarities of this curious region, the *Melisuga Kingii*, a humming-bird which has the extraordinary range of at least 41 degrees of latitude along the western coast of South America, was found braving the frost and snow, as it extracted insects from the fuchsia and other flowers in almost every season; a parroquet, the *Psittacus smaragdinus*, which was first announced by Bougainville, whose assertions were doubted by some theorists, was also found abundantly; and in one part the cormorants, of which there are several species, bred on trees in great numbers.

This vegetation was found to prevail as far as 47° on the west coast, where the survey terminated; but we have a valuable account of the Island of Chiloe, where they were obliged to go for the purpose of refitting. This large island is in the same humid region, and almost constant rain prevails; but, from the latitude, it enjoys a more temperate climate, and the vegetation is abundant and varied. The forests are composed as follows:—

The *Quádría heterophylla*, a handsome tree, in appearance like the ash of Europe, furnishes a light and elastic timber, fit for oars and some other nautical uses. It is known by the name of *avellana* (hazel nut), from the fruit, which is about the size of a cherry, and is roasted and eaten. No doubt it received this appellation from the Asturians who originally settled in the island, the nut being common in their native country.

The *Fágus obliqua Mürbel*, a beech of large size, furnishes the best timber in the island, serving for frames of houses, planking of vessels, &c. There are two sorts; one evergreen, which the writer thinks identical with the *F. betuloides* of the Straits of Magalhaens. We are not told whether one species is preferred to the other, but the description applies to both. The people have given it the name of *roble*, the Spanish for the *Q. Ròbur*, or deciduous oak, no doubt from its general application to the uses for which that tree is, or rather was, applied; for it is now too rare in the part of Spain above mentioned. The periguas (canoes) are principally built of this timber.

Tiqui, a heavy but strong and durable wood, of which the periguas are sometimes built.

Laurel, of which beams and other in-door works are constructed. In these situations it is durable, but will not bear exposure to wet.

The *manu*, a tall and straight tree, resembling a yew in the foliage. It is useful for various purposes in ship-building, and, next to *alerce*, is the best for masts. They endeavoured to procure one for this purpose, but all which were tried were unsound at the heart, no doubt from excess of humidity in the soil where they grew.

Muermo, one of the most useful trees in the island, being used for timbers, trees, and planking of boats, &c., and makes excellent firewood.

*Luma* (*Mýrtus Luma*) is used for poles of carriages, rafters, trenails, &c., and is exported to Lima. The fruit is sweet, and might afford a spirit by distillation.

A tree resembling the walnut in its wood produces strong and very useful timber.

There are several other species, of which the native names are given, of various qualities; but no botanical names are added, for reasons which we shall state hereafter.

The *Araucària imbricatà* is found in the interior of Concepcion, in Chile, in lat. 37°. We are not informed at what distance the forests are inland, but

none were seen near the coast, except a fine cultivated specimen, which was 40 ft. high. The cones are roasted, and sold in the streets under the name of piñones, the Spanish name of those of the *P. Pinea*.

By far the most interesting tree, however, of which we have an account in this work, is the alerce (it ought to be alerce), a large Conifera, of which the principal forests are in the cordillera opposite to Chiloe. The Spanish settlers had conferred this name upon it, no doubt, from some fancied resemblance to the tree of their Arab ancestors (the *Thuja articulata*); but, from the description, it would appear rather to be a pine. The principal account of it is by Captain King; but Captain Fitzroy employed a Mr. Douglas to make an excursion for the purpose of examining the forests, which are now considerably inland, and difficult of access. By his account there are still trees of great dimensions in the interior, the largest he saw being 22 ft. and 24 ft. in girth at 5 ft. from the ground, though they were unsound. The largest felled within the last forty years measured 30 ft. at 5 ft. from the ground, and 76 ft. to the first branches, furnishing 1500 planks, the common proportion of the larger trees being from 800 to 900. He gave an account of a landslip which had carried down 1000 trees a few years since, many of them of large size. Astilleros, or timber yards, are formed in convenient situations, where the trunks are sawn into lengths of 8 or 9 feet, and then split by iron wedges into planks of various thickness, which are carried on men's shoulders to the place of embarkation. So straight is the grain, that they split like slates, and are used for roofing, turning blue by exposure to the weather; and for flooring, and many other purposes. The wood is brittle, but is not subject to warp or cast. The entire tree makes excellent masts, as they experienced; but the difficulty of transport is such, that, although a very large price was offered, it was impossible to procure one in less than two months, and the governor kindly presented them with his flag-staff, which suited admirably. The bark is used for caulking, which purpose it answers while kept under water, but it will not bear the alternation of wet and dry.

The timber is not only in general use at Chiloe, but is largely exported to Lima and other places; and, no doubt, a road to the interior forests would repay the projectors, the people being too poor for such undertakings. Far inland, beyond the reach of the Calbucanos, who carry on this laborious business, are said to be trees of 30 ft. to 40 ft. in girth, and 80 ft. to 90 ft. to the branches, the heads towering 40 ft. to 50 ft. higher. An associated species is called the cypress, which, no doubt, from the description, is different, although Captain King is doubtful on this point. The wood is white, that of the alerce being red, and it does not split so well as the latter timber.

There is a full and ample account of the Falkland Islands, which were surveyed by the expedition. This group, the principal islands of which are of considerable size, has no trees, or hardly shrubs; but, the climate being mild and humid, the vegetation is most abundant, and the cattle and horses, which are running wild, attain a very large size. An account is quoted from a botanist called Vernet, who found twenty-seven species in a space of 12 ft. So great would be the advantages of forming a settlement here, for the purpose of supplying the Australian navigators, and as a depôt in case of future wars, that it is extraordinary no steps are taken for the purpose.

We have now extracted the principal heads of the information afforded us by those officers who very fortunately found time, amid their most multitudinous avocations, to attend to a subject of such interest as the trees of the countries they visited. Probably many of our readers will be surprised when they are told that a regular botanist (Mr. Anderson) formed a part of the expedition, and that, his collections being sent to the British Museum, Captain Fitzroy, who edited the work in Captain King's absence, was led to expect that "a first-rate botanist" would report upon them: but, up to the time of the publication, nothing of the kind had been done, and the public was left without this most necessary and desirable information. Who is to blame

in this extraordinary history? The officers, by no means; who, doubtless, only obeyed the orders given to them. The Admiralty, who, we may presume, issued the orders? Not at all. It was the regular and official course; the British Museum being the place where every description of object collected in each department of government ought to be sent, and carefully deposited. We were sorry to see, quite recently, that some specimens of natural history were sent from the same office to the Zoological Society; which, being a private establishment, and by no means of a fixed and permanent nature, but subject to the will and caprice of the proprietors, who may sell or otherwise dispose of their property at any time, has no right whatever to receive any portion of what properly belongs to the nation, the sole lawful depository of which is the Museum. Can the administration of that establishment be charged with this extraordinary piece of negligence? We apprehend not; for it does not appear that there is, properly speaking, any public botanical department there, the arrangements respecting Mr. Brown's and the Banksian libraries being of a private nature. In fact, it appears it was the business of nobody, and that no one there is to blame for the disappointment of the gallant editor and the public. Who, then, is in fault? Why, the Treasury, or general government, for not carrying out the measure recommended two years since, and for which all the preliminary steps were taken, by the severance of Kew of Garden from the private list of the sovereign, and placing it under the general control of the administration. We very much fear that this most discreditable apathy and procrastination must be charged on my Lord Monteaule, who had it in his power to leave a noble monument of his administration, and of the accession of our youthful sovereign; but, preferring the honours of the stock exchange to the promotion of science, chose to vanish amid a shower of exchequer bills, leaving the amateurs of natural history any thing but cause to lament his exit. We have heard, and the ridiculous absurdity of the anecdote inclines us to believe it to be true, that, every other arrangement being made, a difficulty arose as to the appointment of manager, the question lying between two most eminent individuals, equally fitted to do honour to the country and to those who might nominate them; and that on this the business terminated. If it be so, some steps ought to be taken to settle the question, and not allow such important affairs to be sacrificed to such idle and puerile reasons. Whatever be the cause, it is lamentable to see the little progress we make, and how far the government is behind the intelligence of the public, which is calling out for an establishment of the kind, to which there is no other obstacle than the apathy and indolence of those at the head of state affairs. As it is, we see no hope of attaining this most desirable object but by the strenuous exertions of the leading members of the societies in London, whom it more immediately concerns, and by urging on the government. "Patting on the back" will not do, a stronger stimulus being required. Unfortunately, it is out of the common routine of the Treasury jobbing; and, that "universal fit," the barristers of five years' standing, not being quite qualified in this instance, we fear that, without some strong measures be taken, we shall be allowed to slumber on, being, as far as the government is concerned, behind the most paltry states on the Continent.

The only chance we appear to have at present for the introduction of these curious trees is in the Society of the Regent's Park; and we strongly recommend the managers of that institution, who seem desirous of showing the productions of the entire globe, to consider the subject at their next conversazione. There are only eight or nine gardens and arboretums yet marked out in the prospectus, and surely they could find space for a Hortus Antarcticus. The locality could be easily imitated; there is no difficulty in obtaining bog earth; the granite companies, probably, would supply rocks; and, with the help of shower baths, and the application of bellows on a large scale, the eternal rains and williwaws of that region could be easily represented, to keep the plants in health; whilst the steamer (a gigantic duck, the racehorse of the earlier

navigators, which is capable of paddling along at the rate of fifteen miles an hour) would form an admirable addition to the lake.

Seriously, we hope that this last establishment (which, seeing the ridiculous absurdity of the plan and pretensions it set out with, may by skilful adaptation to the locality, form an ornament, and be extremely useful to the metropolis) be not set as "a tub," to turn the public attention from what it ought to be the object of the government to encourage instead of impeding. From the nature of the prospectus such an idea might be inferred, and, we earnestly hope, may turn out to be unfounded; both for the credit of the queen's government, and to avoid the universal ridicule which will attach to those who have lent their names to such a scheme, should it unfortunately prove to be the case.

We cannot conclude this notice without recurring to the work itself, which, as far as those engaged in it are concerned, is a noble monument of these times. The original expedition was commanded by Captain King, assisted by Captain Stokes, whose physical and moral strength gave way under the hardship he had to undergo. Captain Fitzroy succeeded him; and, on the return of the expedition, was sent out in the *Beagle* to finish some parts of the survey, and extend the observations previously made. Finding the vessel alone to be quite inadequate to the performance of the services, he hired others, until he had incurred an expense he was unable to afford, and applied to have the men he employed paid and victualled at the public expense, proposing still to pay the hire of the vessels himself. This was refused by the Admiralty, and he returned with the service imperfectly performed; at least very much less done than might have been by a very trifling additional expenditure, and with the greater part of his private fortune (we have heard 7000*l.*) expended in following the dictates of professional and patriotic zeal. Except promotion, which was a matter of course, we believe not one farthing of this has been in any way made up to him. We are perfectly aware of the rules, and of the necessity of not allowing the private speculations or views of officers to be introduced as precedents for public expenditure, but there are circumstances in this case of rather a peculiar nature. In the first place, the object was a very noble one; the force under his command *was perfectly and wholly inadequate to the performance of it*. These expeditions should always be confided to two vessels, either separate, or the one as tender to the other, as circumstances may require. The *Beagle*, though a safe and good vessel, had neither the accommodation nor stowage fit for a voyage of the sort; and we invite the attention of any one acquainted with naval matters to the state of a ten-gun brig as described, when ready for sea, with boats on the quarters and on the quarter-deck. It is quite extraordinary how they managed, even to those acquainted with the subject. For these reasons, and on account of the great results obtained, it certainly does appear that some means should be taken of indemnifying Captain Fitzroy for the money he has actually expended in the public service.

We have not mentioned the important assistance afforded by Mr. Darwin, who accompanied the expedition at the desire of Captain Fitzroy to have a regular naturalist attached, because his information, although invaluable, is chiefly on geology, and subjects connected with it, and consequently is foreign to the nature of this publication.

In addition to his promotion, Captain Fitzroy received a medal from the Geographical Society. An anecdote, strange and incredible to those who do not know how the world is governed behind the scenes, is in circulation in "the clubs" respecting the conferring of this medal, to which it is said opposition was offered. It must be observed that in these cases the obligation or honour is reciprocal, or rather considerably to the opposite side of the balance, as held in this instance. A man who, like Captain Fitzroy, has left a name amongst the first navigators of his country, and the results of whose voyages have been considered to place him by the side of Humboldt, had nothing on earth to gain by receiving a medal from any society. In fact, of the two, the

greater honour is conferred on the Society by allowing his name to be placed on their rolls. This is the real state of the case; and, had the opposition succeeded instead of being a thorough and ridiculous failure, it must have placed the Society much in the situation of the Academy at Madrid, which refused to enrol Wilkie amongst its members, and has rendered its medals ever after valueless.

---

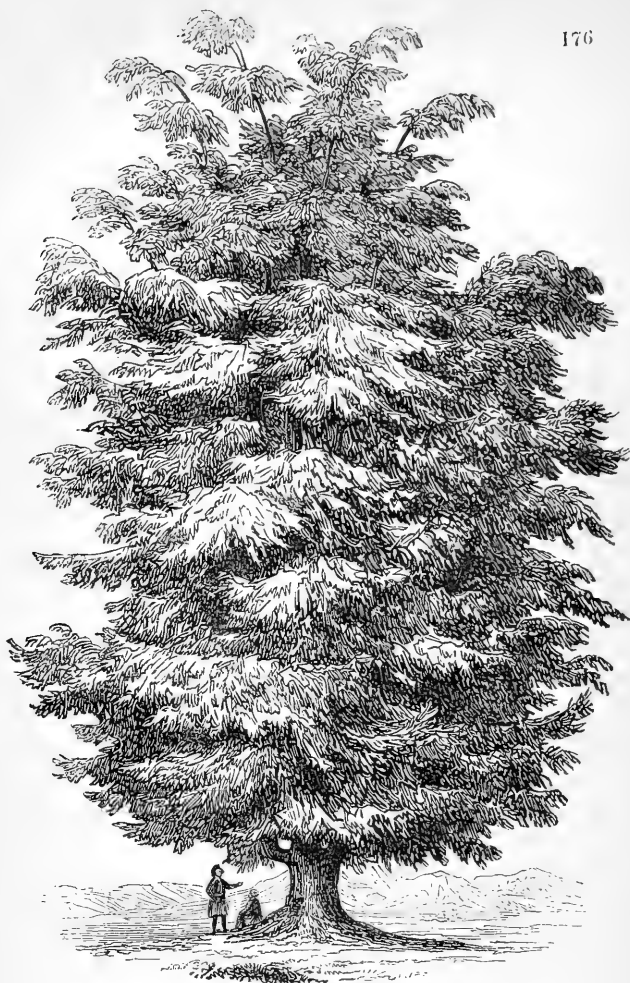
ART. IV. *Descriptive Notice of the Cypress of Mistra.*  
By the EARL OF ABERDEEN.

IN your very elaborate and excellent article on the Coniferæ, in the fourth volume of the *Arboretum Britannicum*, you have made mention of the Cypress of Somma in Lombardy, which you have described as the oldest, the largest, and most remarkable tree of this species, of which there is any record. According to your statement, the dimensions of the stem are 23 ft. in circumference; although you also refer to another account, from which it would appear that its magnitude is considerably less than this. We are informed that the tree itself, although still healthy and vigorous in its growth, has been much injured by the effects of time and accident.

Your correspondent, Mr. Long, in the fourteenth volume of the *Gardener's Magazine*, p. 530., directs your attention to a remarkable cypress which he had seen at Patras; and which, having measured it in the year 1820, he found to be 22 ft. 2 in. in circumference. This is the tree described by Spon in the year 1676; and which, at that time, was 18 French feet in circumference; showing, therefore, an increase of about 2 ft. in the course of a hundred and forty-four years.

The Cypress of Patras was undoubtedly a very beautiful specimen; but I regret to say that, since the visit of Mr. Long, it has been destroyed during the war of the Greek revolution. At what precise time, and in what manner, this destruction took place, I have not been able to learn; but, if it were effected by the Turks, the act was certainly at variance with the superstitious veneration with which these people are accustomed to regard such objects.

There exists, however, in the Morea, another cypress still more celebrated, although less frequently visited than the Cypress of Patras, and which is fortunately still preserved. This is the Cypress of Mistra. It is situated a short distance from that town, on a picturesque spot, at the foot of one of the branches of Mount Taygetus, and about five or six miles from the ruins of Sparta. It is, unquestionably, one of the most magnificent productions of the vegetable world which it has ever been my good fortune to behold. According to my measurement in the year 1803, the trunk was just 26 ft. in circumference, at 4 ft.



*Cypress of Mistra.*

from the ground. I learn, from a statement of its size ascertained in the course of the present year, that no change has taken place in this respect, and that these are precisely its actual dimensions.

I am unable to speak with certainty of the height of this very remarkable tree; but I should think it could not be less than 150 ft. The whole character of its proportions is lofty and majestic. The tree is in perfect health and beauty; although it would appear that any increase of bulk had ceased, at



least for the last five and thirty years. It is of the variety *C. sempervirens horizontalis*; the lateral branches stretching out in every direction, to a great extent.

I am, fortunately, enabled to send you a drawing of this most interesting production [*fig.* 176., reduced one half], from a sketch recently taken on the spot; and which, I hope, will serve to give you some notion of its extraordinary beauty and grandeur.

*Haddo House, Oct. 4. 1839.*

THE Cypress of Somma, referred to by the Earl of Aberdeen, was described, and its legendary history given, in the historical part of our *Arb. Brit.*, p. 169., in an extract from an account given of it by the Abbé Berlèze, in a journal of a tour he made in 1832 through part of Italy, published in the *Annales de la Société d'Horticulture*, vol. xii. p. 76. In that tour the abbé gives the dimensions stated; but as, of course, he meant French feet, the dimensions would be about 21 ft. 8 in. English in circumference, and 75 ft. 10 in. high. The abbé states that it appears that an accident had deprived the tree of its leading shoot, which had altered its general form. With respect to its age, he says, a popular tradition exists that it is as old as the birth of Christ, and hence the tree is held in great veneration by the people of the country. The abbé's brother, however, M. Louis Berlèze, assured him, on the authority of an ancient Chronicle of Milan, that that tree existed in the time of Julius Cæsar, 42 years B. C.

In the spring of 1837 we received from Signor Manetti of Monza a drawing of this cypress, from which *fig.* 177. (published in our *Arb. Brit.*) is taken, together with a letter from which the following is an extract:—

“ We have no certain knowledge as to when or by whom the Cypress of Somma was planted. As a proof of this I may quote the following passage from the work of Francis Campana, called *Monumenta Somæ*, p. 33. line 4.— ‘ Concerning this cypress nothing is known. Every one who has seen its immense size says that nothing more lofty or sublime could be witnessed. Was it planted in the age of the Romans, near the ashes of some patrician? Or is it not older than the age of the Romans themselves? This must be decided by those acquainted with the nature of the cypress, and who are able to measure it.’

“ The fact is, that we have neither scientific nor vulgar traditions which treat in a satisfactory manner of this living monument. It is 121 ft. in height; and its circumference, at 1 ft. from the ground, is 22 ft. At the height of 19 ft. from the ground, the stem is divided into six large branches, which has given rise to the supposition by some that it is not one plant only, but rather

*Cypress of Somma.*

six, planted so close together that in the course of centuries they have become united so as to appear but one tree. I, however, maintain that it is but one plant; because, if it were a union of several, however remote the period, and however perfect the

point of junction might be, some traces of it would be found. The roots extend under almost all the inhabited part of Somma; and, when a public well was dug there, some of them were found above 150 ft. below the surface. The tree, in 1810, was struck by lightning, which destroyed great part of its beautiful head. The inhabitants assert that for half a century it has been evidently in a state of decay; and this is ascribed not only to its age, but to the formation of the new road of the Simplon, which mutilated so many of its roots, that I was told they were carried away in carts.

“ You may see by the drawing that the tree is now rather scant of branches; but I was told that when it was in a flourishing condition, people might have been sheltered under it from the rain; such was its richness in branches and foliage. When Bonaparte gave orders for the formation of the road across the Simplon, which was to be in long straight lines, he ordered that the line which approached the cypress should deviate from its directness, so that respect might be paid to so extraordinary a production of nature. You will see from the figure, that it is the *Cupressus sempervirens horizontalis*. — *Monza, April 24. 1837.*”

To do these two celebrated trees justice, they ought both to have been drawn to the same scale; but, to have drawn the Cypress of Mistra to the same scale as our engraving of the Cypress of Somma, would have made the former engraving much too large for our pages. — *Cond.*

## REVIEWS.

ART. I. *Catalogue of Works on Gardening, Agriculture, Botany, Rural Architecture, &c., lately published, with some Account of those considered the more interesting.*

*SWEET'S Hortus Britannicus; a Catalogue of all the Plants, indigenous or cultivated in the Gardens of Great Britain, arranged according to the Natural System, &c.* By Robert Sweet, F.L.S., &c. Third edition, greatly enlarged and improved. Edited by George Don, F.L.S. 8vo, pp. 799. London, 1839.

A greatly improved edition of a very excellent work. The arrangement being according to the natural system, in that respect the work is superior to our own *Hortus Britannicus*; but it is inferior to it in one very important particular for the young gardener, viz., that the specific names are not always literally translated, as they are in our work. Neither does it contain the heights of the plants, nor the habitats of the British species. It is also totally without the Cryptogamia; and it wants those general views of the natural orders which were supplied to us by Dr. Lindley. Nevertheless, Sweet's *Hortus Britannicus* is an excellent work; and, when we produce a new edition of our *Hortus Britannicus*, we will adopt the natural arrangement also.

*The Hot-house and Green-house Manual, or Botanical Cultivator; giving full Instructions for the Management and Propagation of the Plants cultivated in the*

*Hot-houses, Green-houses, Conservatories, Shrubberies, Plantations, and Borders, in the Gardens of Great Britain. Also the Management of Plants in Rooms. Disposed under the Generic Names of the Plants, alphabetically arranged under the Heads of the Departments of Horticulture to which they belong.* Sixth edition, with numerous additions and improvements up to the present time. By Robert Sweet, F.L.S. 8vo, pp. 762. London, 1839.

Sweet's *Botanical Cultivator* is a work of established reputation, which every gardener ought to possess. The present edition is brought down to the present time, by the insertion of all the new genera in their proper places.

*Hortus Gramineus Woburnensis; or an Account of the Results of Experiments on the Produce and nutritive Qualities of different Grasses, &c., used as the Food of the more valuable domestic Animals, instituted by John Duke of Bedford.* Fourth edition, to which is (for the first time) added, *the Weeds of Agriculture.* The whole revised and improved. By George Sinclair, F.L.S. F.H.S., Gardener to His Grace the Duke of Bedford. 8vo, pp. 362, numerous coloured plates. London, 1839.

A cheap edition of a standard work, which no farmer ought to be without. Figures of all the more important grasses are given, so admirably drawn and coloured, that no person can for a moment mistake them. There are also beautifully coloured figures of clover, and other herbage plants, and of some of the weeds of agriculture; a work with that title being now for the first time printed with the *Hortus Gramineus*. Again we say, that no farmer or country gentleman ought to be without this book.

*The Floral Calendar, monthly and daily, with miscellaneous Details relative to Plants and Flowers, Gardens and Green-houses, Horticulture and Botany, Aviaries, &c.* Compiled, selected, and arranged by James Mangles, Commander R.N. Printed for private distribution. 11 coloured plates, 12 woodcuts. 12mo, 1839, pp. 156.

Capt. Mangles is already so well known to the floricultural world, by the great number of beautiful Australian plants which he has introduced, that any thing from his pen on the subject of flowers comes with peculiar interest. This work is not, however, addressed to the professional gardener, but to the amateur; and it contains simple and practical directions for keeping flowers in the highest possible degree of perfection. The book is, in fact, a description, illustrated by plates, of the captain's own house in Cambridge Terrace; and this is such a floral gem, or rather such a temple of flowers, that his friends must feel grateful to him for explaining how he has contrived to produce so beautiful a result at so comparatively small an expense. As it is, he has certainly succeeded in forming a house, unique of its kind, as exquisitely adorned with painted flowers within, as with real ones on the outside: in short, we may say of it,

“There art and nature ably are combined  
To please the eye, and satisfy the mind.”

To return to the book, the plates are printed in colours, from wood, according to the new invention of Mr. Baxter, and give a very good idea of the arrangement of the flowers with regard to colours, on which so much of the brilliancy of the effect produced depends; and the binding is at once appropriate and elegant. In the end, we have only to congratulate Capt. Mangles on his production, and to express a hope that other amateurs may follow his example, in giving to the world the results of their own experience.—*J. W. L.*

*Vegetable Organography; or an Analytical Description of the Organs of Plants.* By M. Aug. DeCandolle. Translated by Boughton Kingdon. Plates, 8vo. No. IX., for October, 2s. 6d. London, 1839.

We have already strongly recommended this work to the scientific gardener. The translator deserves very great praise for undertaking so valuable a work,

because he can only have been prompted to do so by a wish to diffuse a knowledge of the subject of which it treats. We are happy to find, from a notice to subscribers, that Nos. 10. and 11. will contain many additional sheets of letterpress, without extra charge, and that No. 11. will complete the work.

*Architectura Domestica.* By A. de Châteauneuf. Imp. 4to, 18 plates. London, 1839.

A very elegant work, containing two designs for gardeners' cottages, and several for small villas; but the principal designs are for town houses. Those who are in possession of our *Architectural Magazine* will have learned there that M. Châteauneuf is a native of Hamburg, where he is one of the principal architects; and that he has been distinguished as the author of a very beautiful design for a town-hall for that city. He has also very recently received the second premium for a design for rebuilding the London Royal Exchange. The Swiss cottage at Cheshunt, the romantic, solitary, and almost undiscoverable retreat of H. B. Ker, Esq., which we intend soon to describe and illustrate, received some very picturesque and characteristic additions under M. de Châteauneuf's care when in England, in the spring of 1838. The *Architectura Domestica* will be found chiefly useful to town architects, and to these it presents some very beautiful elevations, and in what may be called the Berlin school.

*The Engineer and Surveyor's Magazine, Railway Journal, and Monthly Register of Practical Science.* No. I. for October, 1839. 4to, pp. 24, with one lithographic plate, and several engravings on wood. 1s.

The first number of this new periodical promises well. In p. 8. there is an interesting article on topographical drawing, well worthy the study of the young gardener.

*The Civil Engineer and Architect's Journal, Scientific and Railway Magazine.* No. XXV. for October, 1839. 4to, with numerous engravings. 1s. 6d.

We introduce the title of this work chiefly for the sake of stating to our readers that, though the *Engineer and Surveyor's Guide* may seem to interfere with it, yet that the two publications are very different, the *Civil Engineer and Architect's Journal* being, in great part, an architectural publication. Every number of the work contains some admirable papers by our correspondent Candidus; and many architects who contributed to our *Architectural Magazine* have become correspondents of the *Civil Engineer*.

*The Guide to Service:—The Maid of all Work, 8d. The Housemaid, 8d. The Dairymaid, 8d. The Nurserymaid, 1s. The Lady's Maid, 1s.* 18mo. London, 1838 and 1839.

To every married gardener who has daughters we recommend those little books; and, indeed, their contents ought to be known to all women, whatever may be their rank. They are calculated for preparing young women to enter on different departments of female service, and to teach those who keep female servants how to treat them properly, and how to know when their servants have done their duty. Without some idea of the feelings of a young woman who has just left school, and is going out as a servant for the first time, it is impossible that we can sympathise with them, or form any correct idea of their pains and pleasures. Without a knowledge of the duties of a housemaid, we cannot form a correct idea of the sort of knowledge which such a person is likely to possess in general matters; and the same thing will apply in the case of the nurserymaid and the lady's maid.

*The Literary World; a Journal of Popular Information and Entertainment, with numerous Engravings.* Conducted by John Timbs, eleven years editor of the "Mirror." Vol. I. 8vo, pp. 428, thirty-six engravings. London, 1839.

Handsomely done up in boards and lettered, 5s. Published also in weekly numbers, Price 2d. each.

We have often recommended the *Mirror* to our readers, and the present work bears a close resemblance to it in plan, but in execution it is greatly superior. The engravings are of a superior kind, and they are printed in the first style of excellence on Dickenson's paper. In a word, when we state that the work is issued from the press of Whitehead and Co., the printers of the most beautiful of the publications of Charles Knight, its excellence may be considered as undoubted. We strongly recommend the *Literary World*, and also the *Year-Book of Facts*, by the same editor, reviewed in p. 179., to every young gardener, and to every one who wishes to give a cheap and elegant present, either to a young or old gardener.

*The Child's Book of Zoology, or Gleanings from Natural History.* By James H. Fennel. Square 12mo, pp. 230, numerous wood-engravings. London, 1839.

Mr. Fennel is advantageously known as the writer of the articles on insects in the *Gardener's Gazette*; and he has here produced a very suitable book for being put into the hands of children, who have just learned to read. We agree with Mr. Fennel in having "always been an advocate for Natural History being included in the early education of all children, for to high and low it may be equally useful." (*Pref.*, p. vi.)

## ANNUAL SUMMARY.

*A Summary View of the Progress of Gardening, and of Rural Improvement generally, in Britain, during the Year 1839; with some Notices relative to the State of both in Foreign Countries.* By the CONDUCTOR.

HORTICULTURE and climate are so intimately connected, that, in reviewing the past year, the weather during that period claims our first attention. For various reasons it will be most convenient in future to begin and end our gardening year with November and October, instead of January and December. The period in question, which has just past, viewed as a whole, may be characterised as sunless and moist; and, though cold, not so much so as to prevent vegetation from being more than usually vigorous. At the moment when we send this to press, various kinds of shrubs are still growing, and those which had long since ripened their wood, such as lilacs, the ribes tribe, loniceras, &c., are bursting their buds. A correspondent, a scientific meteorologist, who pays particular attention to climate and weather relatively to vegetation, has kindly sent us the following retrospective view of the gardening year 1838-9.

*Weather of 1838-9.* — "November was a very wet month, the amount of rain being upwards of  $3\frac{1}{2}$  inches, as registered at the garden of the Horticultural Society; the mean temperature was about  $42\cdot5^{\circ}$ . Strong gales of wind were more prevalent than is usually experienced in this proverbially dull month. On the night of the 28th, the wind assumed the character of a hurricane; the 29th was still boisterous, with heavy rain, and much

thunder and lightning at night. Occasionally the nights were frosty, the degree of cold being sufficient to act as a salutary check on vegetation, which a temperature approaching to 60° in the shade would have otherwise advanced in some instances beyond safe limits. December was seasonable; the mean temperature was upwards of 38°; the amount of rain  $1\frac{7}{10}$  in. The temperature of January, 1839, was between 1° and 2° above the average. This month was, however, remarkable for a hurricane, the violence of which was perhaps as unprecedented in this country as was the severity of the frost in the corresponding month of 1838; for the latter killed various species of vegetation that had survived for centuries, and the former threw down trees that had existed in parks and forests for as long a period. [See details: for England, in p. 91. 195. 477. 571.; for Scotland, in p. 196.; and for Ireland, p. 198.] February was of nearly medium temperature for the period of the season. March was more than 3°; and April more than 4° below the average temperature of these months. This appears to have had the effect of retarding vegetation fully three weeks. The common almond was not in flower before the 12th of April; a week later than in 1838, yet ten days earlier than in 1837; the spring of which was the latest and most sunless of the three. It may be mentioned by way of contrast, that in 1834 the almond was in flower on the 1st of February, a difference of eighty-one days. In the present season the common hawthorn was in leaf on April 20.; and the horsechestnut on April 30. The walnut was in leaf about the middle of May, and in many instances their shoots were then killed by the successive frosts of the nights of the 14th, 15th, 16th, and 17th."

The monthly amount of rain, and the mean temperature, for the period commencing November 1838, and ending October 1839, is as follows:—

		Rain. Inches.	Mean Temp.			Rain. Inches.	Mean Temp.
1838.	Nov.	3·55	42·55°	1839.	May	0·82	52·61°
	Dec.	1·72	38		June	3	59·5
1839.	Jan.	1·27	37·69		July	2·92	61·61
	Feb.	2·19	40·65		Aug.	1·85	61·41
	Mar.	1·95	40·21		Sept.	3·92	57·71
	April	1·46	44·49		Oct.	2·23	51·4

In the neighbourhood of London, 2 inches are about the average quantity of rain for a month.

*Fruit Trees.*—“Orchard fruit trees were generally in blossom about the middle of May, and of course suffered much from the severe frost which then happened. In some parts of the country, the apple blossoms were entirely destroyed. In the neighbourhood of London the blossoms of this kind of fruit on dwarf trees suffered much more than those on standards in the

same locality, as appears from the fact, that a full crop in the case of many varieties could be instanced as having been borne on the latter, whilst scarcely a single blossom was left on the dwarfs, the varieties in both cases being identical. The temperature of May was nearly  $4^{\circ}$  below the average; that of June  $1\cdot5^{\circ}$  and of July nearly  $2\cdot5^{\circ}$ . In the last two months, vegetation, however, progressed very favourably; but, owing to the lateness of the spring, many kinds of fruit were, at midsummer, far short of that increase, with regard to size, which they usually acquire by that period. In consequence of this, not only the maturation, but also much of the growth of the fruit was affected in a period when the days had become greatly decreased in length, and were, moreover, very frequently sunless and wet. The effects resulting from these conditions on the flavour need not be adverted to. Grapes on walls were probably never observed to be generally so imperfect as in this autumn; chiefly owing to the late period of their setting, for up to the end of October there has been no frost to injure them."

*Flowers.* — The summer, on the whole, has been as unfavourable to herbaceous flowers as to fruits, because, though the former have grown with great luxuriance, they have in few cases flowered freely. Pelargoniums, and other green-house plants, which have been turned out into the borders, have, in many cases, not flowered at all; and various creepers and trailers, that used to cover the surface of their beds with one continuous sheet of blossoms, have produced little more than rampant shoots, or an exuberance of foliage, difficult to keep within bounds. This has been the case with the verbenas, and various of the Mexican and Californian annuals. The dahlia, however, is an exception, as that has not only flowered abundantly, but its season has been prolonged to the middle of November, the period at which we now write. The chrysanthemum, a taste for which we are happy to see beginning to revive, is now flowering magnificently in situations where it is trained against a wall, but in the open border it is superabundant in foliage, and it is doubtful whether the season will admit of the expansion of the flower-buds. The different varieties of the China rose have also bloomed later and finer this season than we remember to have seen them; though this last circumstance probably arises from the greatly increased number of new varieties that have lately been originated, or introduced from France.

*Culinary Vegetables and Agricultural Crops* have in general grown with great luxuriance, and Covent Garden was, perhaps, never better supplied with the cabbage tribe, and with turnips and other roots. Field crops of the turnip kind and mangold wurzel are every where excellent. A specimen of mangold wurzel, produced at the West Cumberland Agricultural Cattle



Show, weighed upwards of half a stone; a Swedish turnip nearly as much, and a drumhead cabbage three stone and a half. (See *Farmer's Magazine*, Nov. 1839, p. 375.) In general, where the turnips have been sown on raised drills, they have attained a large size; but where they have been sown on a flat surface, whether in rows or broadcast, the constant saturation of the soil with water has prevented the roots from swelling. Potatoes on ordinary soils are not only much later than usual, but there is an excess of haulm and foliage, which, not having the influence of sufficient light and heat, has failed in producing a proportionate quantity of tuber. In dry soils, however, the crop is considered to be above an average. The crop of peas and beans has been abundant, both in the garden and the field; but the crops of many seeds which require to be ripened, such as the bread corns, clovers, annual flowers, &c., are deficient in quality, and, in consequence, several kinds of garden seeds will probably be scarce and dear in the ensuing season.

*Trees and Shrubs* have perhaps benefited more from the moistness of the season than any other description of plants; because they have not only made longer and stronger shoots than usual, but the mildness of the autumn, and the prolongation of that season into winter, has allowed these shoots time to ripen. In the case of young trees in nurseries or newly made plantations, the annual growth depends jointly on the soil and the weather, especially on the moisture; but in full-grown trees the annual shoots of one year, as compared with another, and consequently the annual increase of wood, depends almost entirely on the quantity of rain which falls during the summer. This has been proved by Mr. Gorrie, in an article which appeared in our preceding volume (p. 132.). In the year 1819, 16 in. of rain fell from April to October, inclusive; and the thickness of the annual layer of wood on a larch, for that year, was 5 in. In 1826, the quantity of rain which fell during the same period was only 7 in.; and the thickness of the layer of wood for that year was but 2 in. In general, we think it may be inferred from this and similar experiments, that, other circumstances being the same, the annual increase of a tree will be as the quantity of rain that falls during the summer months; and that timber trees, instead of being injured by such an excess of rain as proves hurtful to fruit trees, flowers, culinary vegetables, and agricultural crops, are benefited by it.

*History, Description, and Critical Remarks.*— We know of no mode better adapted for improving the taste, either of the young gardener, or of his employer, than that of comparing one garden with another, and searching for reasons for the differences between them. It is a great mistake to suppose that taste is solely a matter of the fancy, whim, or caprice of the indi-

vidual. Every thing in a garden which is referable to taste is as much a matter of reasoning, judgment, and experience, as those matters which relate to culture; and the disposition and outline of a flower-bed ought to be such as can be accounted for on rational principles, no less than the particular mode by which any species of tree is pruned or trained. When any object is to be obtained equally well by more ways than one, as, for example, when it will be equally suitable to lay out a flower-garden in a system of circles, of ovals, or of squares, then the preference given to one of these figures over the others constitutes the taste of the individual, and in so far may be said to depend on his fancy: but, whatever taste may be adopted, it must be governed by the laws and rules of the composition of lines and forms; which have no more dependence on the taste of the individual, than the laws and rules of grammar have on the subject of a discourse.

In comparing one garden or country residence with another, the young gardener has not only an opportunity of improving himself in matters of design and taste, but also in culture; because different soils and situations, different degrees of knowledge and experience in the gardener, and different kinds of wants and wishes on the part of the proprietor, lead to the production of different kinds and quantities of crops, and different degrees of order and keeping. In every point of view, therefore, it is desirable for gardeners and amateurs to visit as many gardens as possible; and the object of our remarks on those which we have visited is, not only to direct attention to these gardens, for the sake of particular points of interest or excellence which they exhibit, but to teach the art of observation and enquiry, generally, to the young gardener.

Among the various articles which, in our Table of Contents (p. iii.), will be found classed under the head of General Subject, those of most interest we consider to be the notices of gardens in the North and West Ridings of Yorkshire (the writer of which is an excellent practical gardener), and our own notices made during our professional tours. Among the latter, Chatsworth and Elvaston Castle afford some instructive lessons in culture, as well as some original ideas in matters of construction and of taste. The garden of Mr. Bonham, though occupying a mere speck of ground, shows what may be effected in a minimum of space in the country; as that of Mr. Ingpen (Vól. XIV. p. 456.) does what may be accomplished in town. We have since seen, in Chapel Street, Edgeware Road, a miniature town garden very similar to that of Mr. Ingpen, where its proprietor, Mr. Allen, has shown a degree of taste and floricultural knowledge rarely to be met with in a London householder. Mr. Allen's garden walls are now covered with a splendid show

of chrysanthemums, including many of the best varieties. The advantage of such gardens as those of Mr. Ingpen and Mr. Allen, to persons employed in business all the day, is almost incalculable, as they not only afford a continual source of interest themselves, but they excite in their proprietors an interest in all other gardens and nurseries that are accessible to the public, as well as in all gardening and botanical books. The garden of Captain Mangles in Cambridge Terrace, Hyde Park, though altogether unique, may here be mentioned, as it shows what may be accomplished by window-gardening. Captain Mangles's house, independently of his garden, is a gem of beauty and ingenious contrivance, and is not even done justice to in the captain's own account of it, modestly entitled the *Floral Calendar*. (See p. 702.) We have noticed (p. 570.) the gardens in the heart of the city, belonging to persons connected with the printing-office of the descendants of the celebrated Woodfall (the printer of Junius's letters), as showing what may be accomplished amidst the densest coal smoke, and almost without sun and air.

*Public Gardens.* — It is gratifying to find that the taste for public gardens, though by no means active, is not altogether dormant. The Kent Zoological and Botanical Gardens (see p. 421.) have been opened in the course of the year, and a botanic garden has been commenced at Bath. A scheme has been also proposed for forming subscription botanic gardens out of part of the park at White Knights (see p. 624.); and government has given orders for the commencement of a National Arboretum to be planted in the New Forest (see p. 624.). The Royal Botanic Society of London has this year obtained a charter of incorporation; and, as its committee has our own remarks in p. 322., and those of our intelligent correspondent Capt. Cook (p. 695.), to guard it against the absurdities in its original plan, which are also alluded to in our Summary for 1838 (Vol. XIV. p. 559.), we trust that it will produce something worthy of the metropolis. An arboretum is being laid out under our direction at Derby, at the expense of Joseph Strutt, Esq., which, when finished, that gentleman most liberally and benevolently intends presenting to the town. In our next volume we propose to give a plan and description of this garden. In the mean time, the example set by Mr. Strutt will, we hope, be followed by other wealthy individuals. The chief circumstance to be regretted respecting public gardens is, the very inefficient manner in which they are commonly kept up. We scarcely know of a public garden in Britain, that is not suffering at this moment for want of funds. We know of only one effectual remedy for this evil; which is, to establish such gardens at the expense of the town or the county in which they are situated, and to support them

by municipal or county taxes. A very trifling tax on the housekeepers of the metropolis would support four botanic gardens in the suburbs, of from fifty to a hundred acres each, which might afford recreation and instruction to the whole of the inhabitants. Let us hope that some wealthy individual will form a garden of this kind, and then present it to government, to the whole metropolis (which ought to have a government of its own), or even to the city of London alone, on condition of this garden being always kept up in proper order, and of its being open to the public.

*Provincial, Botanical, and Horticultural Societies* continue to effect good, by stimulating gardeners to improved modes of culture; by encouraging cottagers to make the most of their gardens; and, what we value most of all, by bringing the rich more into contact with the poor. We cannot help thinking that we already see the good effects of this in the more humane and kind manner in which country gentlemen speak to their out-door servants, and especially to gardeners, and country labourers and their families, than what they used to do thirty years ago. It was then very common, when a gentleman was showing a stranger round his estate, to open the door of a cottage or of a small farm-house, without knocking or giving any previous signal; but this piece of thoughtless rudeness or heartless conduct is, we believe, comparatively rare at present among educated men of wealth; and certainly, at no period within our remembrance, have the female branches of a country gentleman's family been so attentive to the poor in their neighbourhood. But it is not merely the rich employers that have profited by coming in contact with their poorer brethren; the latter also have received a degree of polish and of manner that cannot fail to raise them in their own estimation, as well as in that of their employers. On glancing over our article on the Provincial Societies (p. 674.), it will be seen how much real good has been effected for the cottager in a variety of instances; and for the residents in towns who rent small portions of ground in the suburbs, in the case of a horticultural show at Falkirk (p. 691.).

*The Science of Gardening* has received no marked accession in the course of the year, but the general views which we took in our summary for 1838, of the scientific results of the effect of the previous winter, have been confirmed and extended by Dr. Lindley, in an elaborate and ably reasoned paper in the *Horticultural Transactions*, of which an abstract will be found in this volume, p. 574. to 578. The most material fact to be added to what we had previously stated is, that the ground in the Horticultural Society's garden was never, during the whole winter, frozen to the depth of a foot, even while the temperature of the

surface was as low as  $4\cdot5^{\circ}$  below zero; and that it did not fall within  $5^{\circ}$  of freezing at the depth of 2 ft. This circumstance accounts for so many trees having sprung up again, which were killed down to the ground, and proves the immense importance of mulching the ground about the roots of tender plants. If the frost at zero cannot penetrate through a mass of solid moist earth 1 ft. in thickness, so as to freeze it, it will probably not penetrate at all through a stratum of 6 in. of loose litter, leaves, or other matter, so arranged as to throw off the rain, and remain dry. Almost everything in mulching depends on the mulch acting as a roof to the soil, and carrying off rain or melted snows to 2 ft. or 3 ft. distance from the stem of the plant. If the mulch, instead of conveying off the rain, allows it to sink in, it will, in many cases, do more harm than good, by moistening the soil, and lowering its temperature. The importance of fermentation in fitting food for becoming nutriment to animals, and organised matter for becoming manure to vegetables, has been alluded to in our General Notices (p. 186.), and also in p. 648. Various articles on soils, draining, on the choice of seed, on varieties, and on different other scientific subjects, will be found under the same head, which, though not altogether new, are yet placed in a popular light, so as to be understood and applied by the practical man. On the temperature and moisture of the atmosphere of hot-houses, and relative subjects, some interesting papers will be found in the present volume, by Mr. Wailes (p. 506.), Mr. Beaton (p. 552.), and Mr. Ellis (p. 481.); but much still remains to be done in this department of house culture, which will probably not be accomplished till we have a more accurate knowledge of the different natural climates throughout the world. In systematic botany, Dr. Lindley has made what appears to us an improvement in the primary divisions of the vegetable kingdom; but, as this scarcely comes within the limits of our plan, we refer to the *Botanical Register* for 1839, p. 76. to 81. of the Monthly Chronicle of that work.

*New Agents of Culture.* — Of new gardening implements or engines, but few occur to us as having been introduced or become popular during the year, which are worthy of notice. Rogers's conical boiler for heating hot-houses by hot water appears to have the preference over most other forms for houses and pits of small size, and, judging from the experience had of it in the Horticultural Society's Garden, deservedly so. The form has been more or less in use for a number of years, but failed to attract much attention till made of cast iron by Mr. Shewin, an ironmonger at Sevenoaks, in Kent. The boiler is formed of one cone placed within another, both cones being truncated; the bottom of the inner cone being the grating on which the fire is placed, and the space between the cones, which

is only a few inches in width, containing the water to be heated, and communicating with the pipes in which the circulation is carried on. The hollow cone in the centre may be either wholly or partially filled with coke, cinders, or any kind of coal that will not cake, and the fire so made will continue to burn slowly for many hours, without any attention on the part of the gardener. This boiler costs little compared with others, is not liable to go out of repair, and it may be set by any common bricklayer. It is not, however, adapted for extensive concerns where much heat requires to be generated in a short time. For all such cases, fireplaces in which the fuel can be readily and frequently stirred and added to are essential. The flattened crown glass mentioned in p. 614. as being used at Chatsworth, and in the Horticultural Society's Garden, and as being equally clear as, and much stronger than, crown glass, and not much dearer, and at the same time capable of being used in panes 40 in. in length, promises to come into general use in plant structures. Had this glass not been lately brought into use, it is not improbable that plate glass would have been employed for the roofs of conservatories where the panes are large, as in the end it is found more economical than crown glass; which, when in large panes, is liable to be broken by hail in summer, and by water freezing between the laps in winter. An elegant and economical trellis for fruit trees, by Mr. Booth, is described in detail in p. 632., and, when known, we have little doubt of its coming into general use. This kind of trellis is equally eligible as an invisible fence in pleasure-grounds, and for this purpose we have lately had it put up without any stay-bars above ground; a mode readily effected by means of cross pieces of stone or of wood sunk beneath the surface. An excellent fence of this kind has been put up by Mr. Porter of Thames Street, as a boundary to the lawn of the Holme, the elegant villa of J. Anderson, Esq., in the Regent's Park; and, though there is a part of this fence very much curved, there is not a single stay-bar to be seen from one end to the other. As far as we are aware, it is the first curved invisible wire fence that has been put up without a visible stay-bar; and we most strongly recommend this mode to be adopted on every occasion. A light folding-ladder (p. 56.), a new kind of wire netting (p. 222.), a propagating box (p. 21.), various modes of forming garden tallies and labels (p. 542.), an earwig trap for dahlias, a pot for orchideous plants, an underground water-holder, a new boiler for heating by hot water, and various other agents, will be found by reference to the contents of our *Miscellaneous Intelligence* (p. vi.), and deserve the attentive examination of the practical gardener.

In *Plant Structures* we would direct attention to Mr. Paxton's mode of constructing hot-houses on the ridge-and-furrow prin-

ciple, the advantages of which have been noticed in p. 452. and 661. We have no doubt whatever of the superiority of these houses to those built in every other mode of construction hitherto in use for botanic stoves, and even pine pits; and, when the flattened glass, in panes 40 in. long, is employed in this kind of house, it will be one of the most perfect of plant structures. It is probable also that Wetterstedt's metal, which is said to have all the advantages of lead, with less weight, and to cost much less, may be used for covering the sash-bars on the upper side, so as to add greatly to their durability. We expect to be enabled by Mr. Paxton to give, in our ensuing volume, a detailed account of his mode of constructing ridge-and-furrow hot-houses.

An improvement in the formation of the paths of hot-houses, by Mr. Paxton, is noticed in p. 453.

*Gardening Operations.* — Some new modes of budding and grafting have been described; a mode of hardening garden walks by means of tar and gas liquor (p. 618.), and one of forming them of asphalte (p. 188.), have also been mentioned. The latter kind of walks may probably be introduced with great advantage on steep declivities, where gravel is apt to be washed away by heavy rains and melting snows. Indeed, as the keeping in repair of walks is a material item in the expense of garden scenery, if a permanent walk could be found out that would require neither weeding nor rolling, nor to be repaired with fresh gravel, nor to be renewed every three or four years, and that would at the same time not require the edgings to be continually pared, it would be a very great advantage, both in an economical point of view, and as a matter of taste. As a matter of taste, it would secure fixed edgings, the continual paring of which by the spade is to us one of the most offensive practices in the care and keeping of gardens. The great objection to the asphalte, as at present laid down, is its colour; because, though at first it may be covered over with powdered granite or fine Kensington gravel, yet these materials soon wash off with rain, or wear off by the feet, and leave the asphalte in its native blackness. The employment of Arnott's stove for heating hot-houses has been noticed in p. 107.; and the use of the husks of oats, as a substitute for tan and stable manure in forming hot-beds, is mentioned in p. 248.

*On the Insects injurious to the Orchard.* — One of the best articles which has yet appeared in this Magazine will be found in the present volume, p. 171. Mr. Westwood's article in p. 103. maintains the high character of all that is written by that gentleman; and his two works reviewed in p. 30. and p. 32. will be found of the greatest value to the entomological student.

*The Effects of Kyanising Wood*, with reference to living plants, has been noticed in different parts of the present volume. The result seems to be, that the Kyanising liquor is made so strong, that more corrosive sublimate is deposited, not only on the outer surface of the wood, but in its interior pores, than is wanted for entering into combination with the albumen. This superfluous quantity, then, in the case of hot-house rafters or sash-bars, being sublimated by the great heat of the house, escapes even through several coats of paint, contaminates the atmosphere, and injures vegetation for a time, till the source is exhausted. As the wood, when steeped in the Kyanising fluid, absorbs water in a considerable quantity, as well as mercury, it is easy to conceive that the heat of a hot-house will raise the temperature of the rafters and sash-bars, which are always in the hottest parts of the house, to such a degree as to expand the water into vapour, as well as the corrosive sublimate; and, thus pent up, the elastic fluids produced will readily burst through any layers of paint that could be laid on. A safe mode, when Kyanising for plant structures, would appear to be, to use the Kyanising liquor much weaker than is generally done; and, after the wood is removed from the tank, to dry it as thoroughly as if it had not been Kyanised, in order to get rid of the water absorbed during that process. Respecting the effect of the process on the durability of wood, some interesting experiments will be found recorded in p. 320.

*Landscape-Gardening.* — The observations on this subject, in the present volume, are chiefly contained in the descriptions of select suburban residences. In the account of Redleaf (p. 353.), and in that of Mount Grove (p. 1.), the modes of composing beds of flower-gardens, so as to give them connexion and character, will be found exemplified; as is the use of rockwork at Redleaf and St. Clairtown (p. 49.). At Garden Cottage, Cheshunt (p. 633.), is shown the mode of conducting several walks over a limited space, so as never to show more than one walk at a time; and in the grounds there are examples of almost every kind of garden structure, and also of the gardenesque style of planting trees and shrubs.

It is worthy of remark, that, while so many gardeners contribute papers to this and other gardening journals on different points of culture, it is rare to find an article by a practical gardener on landscape-gardening. The reason is, that, while there are a great many cheap books on gardening as an art of culture, there are comparatively few on gardening as an art of design and taste, and these few are scarce, and extremely dear. To remedy this evil, we have commenced a series of four or five octavo volumes, in which we intend to include a reprint of all the best works on landscape-gardening which have



hitherto appeared, to be sold at a price within the reach of every gardener.\*

There is one part of a country residence in which almost every gardener is called upon to display his taste, and that is, in laying out flower-beds on a lawn, in a pleasure-ground, or in a scene by itself, to be treated as a flower-garden. This the gardener generally does under the direction, or, perhaps, with the assistance, of the ladies of the family; but seldom in such a manner as not to be open to great objections. The utmost pains seem to be taken to vary the form of the beds, in consequence of which, we have not only circles, ovals, and other regular figures, but hearts, Maltese crosses, stars, darts, commas, figures like saddle-bags, kidney potatoes, leeches, tadpoles, worms, anemone or ginger roots, pincushions, cloak-pins, and various other figures, all in the same design, and each so isolated from the others, as to be distinctly seen. Now, there is no objection to any of the figures mentioned, or to any other figures that it is possible to conceive, provided they are worked up or associated in such a manner as to form a connected, expressive, and characteristic whole. It is only necessary to remember, that, the greater the variety of figures, the greater will be the extent of ground required to combine them into a whole; because a great number of peculiar figures, such as hearts, Maltese crosses, &c., can only be formed into a whole by a great number of the same figures, or by connecting them with simpler figures; but where only two or three forms are made use of, a connected whole may be displayed in a very limited space, whether that space have a regular or an irregular outline. In general it may be observed, that the connexion and the size of the figures are of much greater consequence than their shape; and hence the most beautiful description of flower-garden, *ericacetum*, or of American ground, or rosary, as we have shown in the *Arboretum Britannicum* (vol. ii. p. 1178.), may be made of circles alone. As a further proof of this, we may refer to those beautiful places, Norbiton Hall and Teddington Grove, described in p. 424. and 426. That the most beautiful and artistical flower-gardens may be laid out by ladies in as high a taste as by professed landscape-gardeners, we have the evidence of those laid out by the late Lady Farnborough, at Bromley Hill; by Lady Grenville, at Dropmore; by Lady Boughton, at Hoole House; by Mrs. Robert Phillips, at Heybridge, near Cheadle; and by various others. We do not deny, however, that a certain degree of natural taste for the beauty of lines and forms, as well as its cultivation, is necessary to enable either a lady or a gardener to design such gardens as those we have mentioned; but we maintain, that, with nothing

\* We have commenced with Repton's works, which were originally published at 25*l.*, but which may now be obtained for 1*l.* 10*s.*

more than common natural taste, and the possession of good sense, every gardener may acquire sufficient knowledge, not only to prevent him from committing absurdities such as those we have mentioned, but to enable him to make very good designs for ordinary situations.

As a flower-garden is a part of a country residence which may in most cases be judged of by itself, without reference to the rest of the place, we have, in an advertisement, an extract from which is given in a note below\*, stated the terms on which we give designs for flower-gardens, or correct the plans of those already made; and we have done this, because we are aware that a great number of persons are deterred from employing a landscape-gardener from a fear of the expense. Were the expense double or treble what it is, it would still amply repay the proprietor of taste, and even the economical proprietor, to incur it, rather than proceed in the dark, even in such a comparatively humble matter as that of laying out a flower-garden.

\* A visit to any place not exceeding 12 miles from London, and not occupying more time, including going and returning, than from 9 in the morning to 5 in the afternoon, including all expenses

expenses	-	-	-	-	-	-	£5	5	0
Above 12 miles, and not exceeding 20, including all expenses	-	-	-	-	-	-	6	6	0
Above 20 miles, 5 guineas a day, from the time of leaving Bayswater to that of returning to it, and travelling expenses, by post.									
Consultation by letter, or by the party calling at Bayswater	-	-	-	-	-	-	1	1	0
A design for a flower-garden, the ground plan (and sections, if the surface is very uneven) of the area on which it is to be laid out, with the places of entrance and exit, being given	-	-	-	-	-	-	5	5	0
A plan of a flower-garden sent for correction	-	-	-	-	-	-	2	2	0
Or, if the corrections require a new plan to be made	-	-	-	-	-	-	4	4	0
A sketch, with working drawings, for any ornamental garden building of ordinary dimensions, to be erected of rustic work	-	-	-	-	-	-	5	5	0
A sketch, with working drawings, of an architectural garden building, a gardener's house, an ornamental cottage for a labourer, or a lodge for an entrance gate	-	-	-	-	-	-	10	10	0
A sketch and working drawings for an entrance gate and piers	-	-	-	-	-	-	5	5	0
A design and working drawings for a farm-yard, the kind of farm and its extent being given	-	-	-	-	-	-	10	10	0

When plans are sent for correction, subjects for an opinion, or lists of trees, shrubs, &c., are wanted, which it will require a considerable time to prepare, the charge for consultation will be increased in proportion to the time occupied, at the rate of 5 guineas for a day of 6 hours.

Perhaps it may excite surprise in some, that, after having been known as a landscape-gardener since 1804, we should now think it necessary, as it were at the eleventh hour, to advertise our terms. But the truth is, that, in consequence of ill health, we have for the last twenty years relinquished all employment of this kind, except in the immediate neighbourhood of the metropolis. The reason why we now propose to resume our profession, as regards distant places is, that we find it absolutely necessary for the continuance of our present improved health, (having only lately recovered from an illness of nearly two years' standing, brought on by the incessant labour of bringing out the *Arboretum Britannicum*), to be a good deal in the open air; and professional employment promises the motives as well as the means for this purpose.

There are certain errors in laying out grounds, which are founded on mistaken notions respecting the situation, and the operations which art ought to perform, either to heighten the natural character, or to counteract it by producing a character of another kind. Such errors can neither be detected nor corrected without seeing the place; but there are other errors, totally independent of situation and character, which occur in almost every place, and which every gardener, or employer of gardeners, may correct if he chooses, without professional assistance of any kind. Of these errors we shall here point out one or two, which we have been anxiously endeavouring to correct for upwards of thirty years, and, we regret to say, with very little success.

The first error alluded to is, the practice of annually digging the ground in grown-up shrubberies and plantations, and endeavouring to grow herbaceous flowers and roses along their margins. We object to this practice, because the digging does little or no good to the trees and shrubs after they have attained a certain age; and because, the ground being filled with their roots and shaded by their branches, flowers and roses under such circumstances can never thrive. We object to digging grown-up shrubberies for another reason, viz. the destruction of all stability, and repose of expression. Digging, like other modes of culture, is but the means to an end; and, in the case of grown-up shrubberies, this end is already attained, as far as concerns the soil. The object of raising a shrubbery, then, being to produce what may be called a refinement on a path through a wood consisting of undergrowths and trees (but differing from such a scene, in having the path gravelled, and the trees and shrubs of a great variety of sorts), the digging destroys all allusion to nature, while it creates no character of art fit to be a substitute.

Herbaceous flowers and roses may be grown in the margins of shrubberies and plantations for a few years after they are newly made; and they may also be grown in shrubberies or beds of low flowering shrubs, such as Persian lilacs, rhododendrons, ribeses, &c., which are taken up every three or four years, reduced and planted in fresh soil; but under no other circumstances would we plant, or continue to grow, flowers or roses among shrubs or trees.

Since the shrubbery is not to be dug, except for a few years after it is first planted; and since all roses and flowers are to be removed from it, when they can no longer be grown so as to produce handsome specimens; how, it may be asked, is the surface of the ground among the trees and shrubs to be treated? To this we answer, that, if the gardenesque mode of management is adopted (that is, the mode by which every individual

tree and shrub is treated so as to display its peculiar size and shape), then we say, thin out the trees and shrubs annually, so that the extremities of their lower branches may always be within a few inches of touching one another, and yet never suffered to touch; and, if weeds or grass rise up in the intervening spaces, mow them, or cut them down close to the ground with a sickle, as soon as they appear. In autumn and winter sweep up the fallen leaves, and carry them to the compost ground, or merely sweep them under the branches of the evergreen shrubs at the back part of the shrubbery.

On the other hand, if the shrubbery is to be treated in the picturesque manner, thin out the trees and shrubs more sparingly than when operating for the gardenesque, allowing their branches at all times to touch, and even to intermingle; and leave both trees and shrubs not isolated as in the other case, so as to show their individual shapes, but connected in some places in twos, threes, fives, &c., so as to form elegant groups; and close together in other places for some distance, so as to form ample masses of undergrowths of varied outline. In a shrubbery or plantation so treated, the ground will be almost everywhere covered with the undergrowths, and scarcely any grass or weeds will come up, but, wherever they do, they should be cut over with a sickle or scythe.

In both gardenesque and picturesque shrubberies and plantations there will occur occasional glades of turf; and on these glades single shrubs, and even single flowering plants of vigorous-growing kinds, or in shady moist places ferns, may be allowed to appear; but the turf must be closely mown round the plants, and close up to the shrubs.

The next error which we shall point out respects the box edgings or grass verges, which are made along walks in shrubberies and plantations. In the case of all shrubberies, the walks in which are destined eventually to become shaded or covered by the trees or shrubs, these edgings and verges are to be considered merely as temporary lines of separation between the walk and the dug ground, till the latter is covered with the branches of the shrubs. On the other hand, in those shrubberies where the walk is destined to be at all times exposed to the sun and air; such as an open walk, with a border of trees and shrubs on one hand, and a lawn with scattered groups of shrubs and trees on the other; then, after the period of digging is over, the grass verge ought to be encouraged to extend itself under the branches of the shrubs, and there to lose its outline altogether. In technical phrase, all the naked ground within the verge ought to be turfed up; that is, covered with turf, or, as a substitute for turf, made perfectly smooth, firm, and even, and sown with grass seeds. No matter if the grass,

whether of the turf or seeds, do not grow, except in the more open places; the smooth firm surface, which will soon become green with moss, is more natural, and consequently more beautiful. Box edgings, for shrubberies of this kind, and indeed for any shrubberies, are altogether unsuitable, and should be confined to the flower-garden or the kitchen-garden.

In the case of a shrubbery, the walk in which is destined ultimately to be shaded by the trees on both sides, the turf verge will after a few years become naked, or covered with moss instead of grass. Whenever this is the case, turf up, as in the case of open shrubberies.

Very different from this is the common mode of managing the edges and verges of grown-up shrubberies. The box is suffered to remain, however ragged and miserable it may look, and the turf verge continues to be pared on both sides, till it is reduced to less than half its original width, a little gutter being formed in the inner side of the verge; and the whole shows the application of labour to a purpose neither productive of beauty nor use, but, on the contrary, continually obtruding on the observer the unsuccessful efforts of the gardener in endeavouring to cause plants to grow where they have not the requisites of health.

There are some shady shrubberies where the original verge is totally obliterated by the operations of the gardener; that is, where the verge has been literally pared away altogether. In this case it is not uncommon to find either a notch or gutter made along each side of the walk to mark its boundary, or a row of small stones, pebbles, or flints, put down for the same purpose. The true mode to proceed here, however, is, to restore the original verge, to level the ground inwards among the branches, and to leave it to become covered with moss, as already directed. In certain cases, ivy, tutsan, or any other low trailing or creeping evergreen, may be allowed to cover the soil among the shrubs, and to extend over the walk, provided that in shortening these shoots they are not cut off in one even line, but thinned and cut out, so as to form an irregular boundary.

The common mode of treating the branches of shrubs which grow along the margins of walks, and have a tendency to spread over them, is the next error that we shall point out. Every one who has the slightest taste for picturesque beauty must be disgusted with the hedge-like appearance which is frequently given to laurels and other evergreen shrubs, which grow along the margins of shrubbery walks. There is scarcely a place where the shrubs are of ten or twelve years' growth, where this, to us, most offensive appearance is not to be met with; and, when it is connected with a meagre turf verge pared away on both sides, or the ragged remains of a box edging, it forms the climax of shrubbery deformity. The remedy for this evil is very simple.

Instead of cutting off the points of the shoots, let the gardener cut out large branches, or even cut out some entire plants, so as to produce bold inlets in some places, and bold projections in others. In doing this, let him beware of forming an outline by alternate outlets and inlets of nearly the same size; for such an outline, taken as a whole, will be almost as regular as the other, though not quite so monotonous. He must make large openings in some places, and smaller ones in others, and vary these in size and situation, so as to produce features; that is, part of the outline must be chiefly characterised by prominences, and other parts by recesses, and some of the prominences must be higher than others, &c.

We dislike all absolute rules, and must never be considered as giving any that are not liable to exceptions; but if there is one rule in the management of pleasure-ground that admits of fewer exceptions than another, we think it is this — that there ought to be no part of a pleasure-ground dug after the trees and shrubs are fairly established, except the flower-beds. In some soils and situations, the trees and shrubs will be established in two years; in others, it may require three or four, but in none can it require more than five or six; and from the period when the trees and shrubs are established, whatever that may be, all digging of the surface, and all paring of the inner verge, ought to cease, except in beds solely devoted to flowers, roses, or some of the more delicate kinds of peat earth shrubs.

If those errors, which we have pointed out in such detail as to be understood by every gardener, were avoided, there would be a considerable saving of labour, which might be applied to the higher keeping of the flower-gardens, the beds of which are, in very few places that we know, kept properly covered with flowers.

The grand cause of all these errors, we think, arises from this; that a practical gardener, who is not a reader, and who has not paid considerable attention to landscape-gardening, being constantly occupied with the means, mistakes these for the end of his art. Hence, he considers freshly pared verges (which to us are an abomination, for reasons many times before given, and indeed so recently as in p. 672.), freshly hoed and raked surfaces, evergreens cut in so as to form a close compact hedge-like surface, and dug ground among grown-up shrubs and trees, as evidences of care and labour, beyond which he has not acquired the faculty of seeing. It is, therefore, for the employer of the gardener of the old school, to require of him, as a rule, to practise what we have been recommending; and, for the gardener who belongs to the rising generation, to cultivate his taste for landscape-gardening, so as to be able to practise it from principle.

*Arboriculture.* — Judging from the favourable reception which our *Arboretum Britannicum* has met with, even among nurserymen, we should say that the taste for rare and beautiful trees and shrubs is on the increase. The information received from nurserymen, and the great number of applications to the Horticultural Society for scions of *Cratægus* and other fine trees, confirm this opinion. The number of new species and varieties raised in the Horticultural Society's garden during the last year, including several new species of pines from Mexico, will be found in Mr. Gordon's *Report* in our ensuing volume. Some additional matter to what is contained in our *Arboretum*, chiefly relative to pines and firs, will be found in preceding pages (see p. 109. 118. 236. 224. &c.); and indeed we recommend the reader to turn at once to the article *Arboriculture* in the Table of Contents (p. iv.), in which he will find the titles of several articles of great interest. The most interesting facts in regard to the multiplication of rare trees are, that thousands of young plants of *Araucària imbricatà* and *Pinus Llaveana* have been raised from seeds; and that the deodar cedar may be grafted with the greatest ease on the common cedar, and by that means grown more rapidly than when raised either from cuttings or seeds. It will be the fault of the public, therefore, if these three handsome trees are not soon as common throughout the country as the cedar of Lebanon, with which they are on a par with regard to hardiness. We recommend to the attention of our readers our own observations on the recent plantations in Kensington Gardens and Hyde Park (p. 131.), which, though they have not had all the effect which we intended they should, in removing or thinning out certain clumps and belts, have yet been the means of removing from these a number of diminutive Scotch pines, planted apparently to shelter trees from ten to twenty times their own height. One great object that we had in view in writing the *Arboretum Britannicum* was, to introduce a greater uniformity of nomenclature in the trees and shrubs cultivated in British nurseries. To second the effect of our book in attaining this object, we proposed (see p. 517.) to name collections of trees and shrubs in public gardens and nurseries, if the owners or managers would send us specimens, and print catalogues adopting the names to which preference is given in the *Arboretum*. Some nurserymen have accepted our proposal, but we shall not publish their names till they have printed their catalogues. In the meantime we recommend all intending purchasers of trees and shrubs, to consult the article referred to (p. 517.), before giving their order to a nurseryman. It can be no hardship to the latter, for the purchaser to insist on not getting the same plant under different names, as we have shown he now very frequently does in the case of many genera. While

this is passing through the press, we have observed, with much regret, a catalogue of trees and shrubs published by Mr. Rivers, in which species and varieties are confounded in such a manner as to render the confusion which already exists in nurseries greater than ever. We are particularly sorry to see this; because, in so far as this catalogue may obtain circulation, it goes to counteract all the efforts that we and others have been making to clear and simplify the subject. In short, instead of advancing with the improvements of the present day, it attempts to carry on and perpetuate the faults and errors of the last generation, which we had hoped were about to be completely exploded. Under these circumstances, we consider it our duty to state, both for the benefit of country nurserymen and amateurs, that in Messrs. Whitley and Osborn's nursery, Fulham, the trees and shrubs are more correctly named than they are in any other in the neighbourhood of the metropolis. In this nursery alone, the genera *Cratægus* and *Pyrus* are named exactly as in our *Arboretum Britannicum*.

*Floriculture.* — The Stafford House Flower-Hall, erected by Mr. Glenny, has been noticed (p. 422.) as the best structure for the exhibition of flowers in the neighbourhood of the metropolis; and we trust it will be patronised by the public in such a manner as to answer the expectations of its very spirited and liberal proprietor. A highly scientific article on the growth of flowers under glass covers in rooms, by Mr. Ellis and Mr. MacNab, will be found in p. 481.; and the practice begins to be adopted in London, not only in rooms, but on the sills of windows, where the glass case has the great advantage of preserving the plants from the soot continually floating in the atmosphere of the metropolis. Mr. Bowdery, a bookseller in Oxford Street, whose family have been long noted for their taste for flowers, has, during the whole of last summer, had cases which filled the lower half of his windows, in which he has had roses, pelargoniums, mignonette, and many other green-house and hardy plants in flower all the summer. In the higher districts of floriculture, the *Orchidaceæ* and *Cactaceæ* continue to be the fashionable orders, and some excellent papers on both will be found in the present volume. An article by Mr. Beaton (p. 522.) on the management of orchidaceous plants, and on the gathering and packing of them for long voyages, we consider to be the best that has yet appeared on these subjects. Among hardy flowers, the taste for annuals and bulbs has considerably increased, more especially since it has been found that by sowing many kinds of annuals in autumn, in the beds or borders where they are finally to remain, they will endure our ordinary winters without any protection, and come into flower as early in spring as the earliest indigenous plants, such as the daisy, the hedge



violet, the heartsease, the wallcress, &c. Thus a flower-garden may be covered with flowers from March to November, by the use of annuals alone, at an expense for seeds of only a few shillings. Lists of annuals proper for this purpose will be found in Vol. XIII. p. 498., and in Vol. XIV. p. 407.; and it may be useful to add, that the following kinds stood through the winter of 1838-9, in the Lewisham Nursery, and flowered last spring from February to June, ripening seed so early that a second crop flowered and ripened seed, from which plants raised are at this moment, Nov. 21., in full bloom. The kinds alluded to are: *Nemóphila insignis*, *Collinsia bicolor*, *Schizánthus pinnátus*, *Lasthènia glabràta*, *Clárkia pulchélla*, *Leptosiphon densiflorum*, *Gília tricolor*, *G. capitata*, *Phacèlia tanacetifolia*, and several sorts of *Ænothèra* and of *Coreópsis*. By having the beds of a flower-garden small (and we prefer small circles of different sizes, arranged in groups, so as to form regular or irregular figures, according to the situation), and sowing only one kind of flower in a bed, a splendid display of flowers may be produced and maintained through the floral months at very little expense. We wish much that the provincial horticultural societies would offer premiums for the greatest number of new annuals cultivated by cottagers; and also for the greatest number of flowers in blossom in a cottager's garden, at one time, in each of the floral months. This would lead to a cheap and easy means of giving a splendour to the cottager's front garden which it has never yet had, even highly enriched as it now is, compared with what it was twenty years ago. As the Californian annuals ripen their seeds so freely and abundantly, were they generally cultivated by cottagers, many of the kinds would soon become naturalised in our woods, hedges, and road-sides, so as perhaps ultimately to be ranked by the authors of British floras as indigenous plants. The taste for annuals, among the cultivators of flower-gardens generally, has been not a little increased during the past year, by the publication of *The Ladies' Flower-Garden of Ornamental Annuals*, a work of extraordinary merit and proportionate success, of which we have already spoken (p. 88.), and shall recur to again in the course of the present article.

*Horticulture.* — So few new fruits or culinary vegetables have been introduced in the course of the year, that Mr. Thompson has not thought it necessary to furnish us with a Report, which, our readers are aware, the council of the Horticultural Society kindly permits him to do; extending the same permission also to Mr. Gordon, with reference to hardy trees and shrubs. The most interesting horticultural subject which has come under our observation in the course of the year is, the mode of treating fruit trees by Mr. Barron, at Elvaston Castle, and more

especially peach trees (see p. 460.). We saw the gardens at Elvaston Castle in May (see p. 458.), and again in September. At the latter period the peaches were ripe on the lower parts of the trees, where they received the direct influence of the heat reflected from the tiles with which the border was covered to the width of 4 ft.; while on the upper part of the walls the fruit was quite hard. The difference in the period of ripening between the fruit at the bottom, and that at the top of the tree, is found by Mr. Barron to vary from two to three weeks, according to the weather. The pavement of tiles, which is laid under the roots, is not, as we might suppose, laid down before the trees are planted, but after they have made three or four years' growth. At the end of the third year, half that part of the border which the roots occupy is lifted up, and the tiles introduced beneath the roots at the depth of about 18 in. from the surface; and the fourth year the remaining half of the roots are lifted and paved under in the same manner. By not paving before planting the trees, the latter grow much quicker, from having a greater supply of moisture. Mr. Barron follows exactly the same plan with the dwarf trees planted in his borders, paving under each, after they have been between three and four years planted, a space 12 ft. by 8 ft., and training the head of the tree by means of cords, which tie one branch to another, into a pyramid about 10 ft. high, and about these dimensions at the base. In all this Mr. Barron proceeds on the principle, that, to make the most you can of a tree, you must have as complete a command over the roots as you have over the branches. Exactly the same principle will apply in the culture of flowers, which, to produce a maximum of flowers with a minimum of leaves, must be planted in shallow soil, on a dry bottom, by which, in wet seasons, they will not run to leaves and stems; and in extraordinarily dry seasons, should they not produce leaves and stems enough, they can be watered. The depth of the beds of flower-gardens, and the richness of the soil, are as great enemies to the production of flowers, as the common shapes and arrangement of the beds are to their artistical beauty. To return to horticulture, it is almost needless to add, that, viewing the subject in this light, Mr. Barron never crops his borders.

*Agriculture.* — The English Agricultural Society may be considered as having been commenced in the early part of the year, and as being now firmly established. The Highland Society has been, if possible, more than usually active during the year, and is erecting a spacious building for a museum, library, &c., in Edinburgh, which will cost upwards of 6000*l.*, independently of furniture. At their Inverness meeting, some very interesting discussion took place on the subject of tile-

draining, which we have reported in p. 626. In England, local agricultural societies seem to be on the increase; a very gratifying circumstance, since there is scarcely an art practised in England that is in such a rude state as agriculture in the central counties. As a proof of this, we may refer to a report in the *Gardener's Gazette* (No. 149. p. 714.), of what took place at the Gravesend and Rochester Agricultural Society, by which it will be found, that in Kent the prejudices against two-horse ploughs are carried to such an extent, that though the work of one of these ploughs was allowed to be as well done as that of any other, yet a worthy yeoman "offered to bet 5*l.*, that the half-acre ploughed by the two-horse plough on that day, did not grow so much wheat and straw as the one which adjoined it, and which had been ploughed by a four-horse plough;" and the bet was taken, to be decided next year. It may readily be conceived from this, that Rochester is a very fit neighbourhood for the operations of a "National Agricultural Educational Society," of which a prospectus has been sent us, which proposes to establish a school in Kent for 100 boys. In different parts of England we observe that former agricultural societies have revived, or new ones been instituted.

In Gloucestershire, on the estate of Earl Ducie, an Example Farm is being established under the direction of His Lordship's steward, Mr. Morton, the intelligent author of an excellent *Treatise On the Nature and Properties of Soils*, reviewed in Vol. XIV. p. 151. The extent of this example farm is about 250 acres, and the soil and exposure are about the average of those of the whole estate; so that this farm will present a fair specimen of the kind of agriculture considered by Mr. Morton as best adapted for the soil and climate of that part of Gloucestershire. The implements, horses, and men have been obtained from Stirlingshire, through Messrs. Drummond the eminent seedsmen. Mr. Morton expresses in his book a wish that "a chain of example farms were established upon the various geological formations throughout the country;" and we trust the example shown by Lord Ducie will lead to the adoption of something of this kind by other great landed proprietors. The papers on agriculture in this Magazine are necessarily few, because we limit ourselves to taking such views of the progress of the art as we think may be useful to gardeners. Among the latest improvements may be noticed the introduction of *Màdia sativa* as an oil-plant (p. 142.), and some new varieties of wheat (p. 23. and 24.). *Màdia sativa* has been cultivated by Mr. Taylor, with great success, in Suffolk, and a valuable oil has been produced from it, as will appear in a future communication.

*Rural Architecture.* — A considerable stimulus seems to be given to rural architecture in all those parts of the country

which have been penetrated by railroads; doubtless from the science and beauty displayed in the numerous bridges, viaducts, station-houses, &c., required by this new mode of communication. These examples are not only seen by proprietors, who have occasion to build on their estates, but by the carpenters and masons who are employed in country buildings, and on whom they naturally make a much stronger impression than designs in books. Besides, many of these carpenters and masons have been employed in the erection of the buildings alluded to; and they must consequently have acquired an improved knowledge of construction, with an ambition of carrying this knowledge into practice, which nothing but a combination of similar circumstances could have produced. At the same time, this practical mode of obtaining knowledge and taste, the better fits the mind for acquiring ideas from books; because it renders the mind of a practical carpenter or builder nearer on a level with those of the authors of these books, than it could have been if he had never gone out of the usual routine of his business. Among the details of rural architecture which occur to us as best worth recommending is, the cottage window described in p. 438. which, for cheapness and durability, and as combining at the same time a sufficient power of ventilation, is, we think, unequalled. The stay-bar for windows, doors, and gates, described in p. 439., is also an excellent invention, deserving of general introduction. The lodge-gate fastening described and figured in p. 442. is a humane improvement, arguing a degree of feeling for and attention to servants and other dependants, which, we believe, is not more conducive to their happiness, than it is to that of their masters who sympathise with them. In the description of Redleaf (p. 353.), will be found two plans of workmen's cottages, at once commodious and highly picturesque; and the various farm buildings described in the article on Mr. Harrison's cottage at Cheshunt (p. 633.), contain many valuable ideas for new arrangements. The Highland Society has recently taken up the subject both of cottages and cottage gardens, in consequence of which some improvement in this department of rural architecture and scenery may be expected in Scotland, where it has long been very much wanted. We might mention here a variety of improvements in the fittings up and furniture of cottage villas, which we have recently observed in different parts of the country; but, as they would occupy too much room, and would not be altogether in place in this Magazine, we reserve them for a more fit opportunity.

In *Domestic Economy* we have one very great improvement to notice; this is the invention of Fuller's Ice-box, which will at once be a considerable saving to those who have ice-houses of their own, and will enable those to enjoy the luxury of

ice who have hitherto not been able to afford the expense. We refer the reader to our account of this invention in p. 654. The next improvement we shall notice, is one which has been introduced nearly half a century, but which, strange to say, has made but very little progress compared with its great merits. This is the Roasting Oven, invented by the late Mr. William Strutt of Derby; and of which we have lately seen one in the house of Mr. Joseph Strutt, which has been in daily use for upwards of thirty years; saving much labour and fuel, and roasting every description of meat in a manner superior to an open fire. We shall not stop here to describe this oven, as we have done so in our *Encyc. of Cott. Arch.*; but shall rather refer our readers to Mr. Joseph Hunt, ironmonger, Derby, who fits up these ovens for 10*l.* 10*s.*, including all expenses, except carriage and travelling; and to Mr. Stephens, ironmonger, Great Russell Street, Bloomsbury, who has been in the habit of fitting them up occasionally in the metropolis and its neighbourhood. An economical hot-closet is described in p. 447., and an improvement on Arnott's Stove is noticed in p. 446.; the greatest improvement in this stove, however, has been made by Mr. Jeakes, Great Russell Street, who, by placing it within a case and introducing fresh air, has rendered it effective in ventilating, as well as in heating. Dr. Arnott himself has also made some improvements in this stove; but, though we have examined those recently erected under his direction in the Custom-House, they do not appear to us, even on the large scale in which they are formed in the Long Room of that building, to give sufficient ventilation. In short, this is only to be accomplished by the principle adopted by Mr. Strutt in his cockle stove, by which fresh air heated to a proper temperature is continually introduced. This has been done by Mr. Strutt, by smoke, on a large scale; and by Mr. Jeakes, in his improvement on Arnott's stove, by smoke on a small scale; while, by Mr. Manby and others, it is effected by hot water. In the case of small houses this plan is unsuitable, and perhaps Arnott's stove, as improved by Jeakes, will be found preferable; but, in all large houses, a cockle or hot-water apparatus placed on the cellar floor, and the heated air admitted into the hall and staircase, are all that is required for comfort. This has been ably shown by a philosophic writer in the *Architectural Magazine*, who possesses one of the most complete houses in Britain, which we hope shortly to be able fully to describe. We have examined the Chunk Stove, a contrivance closely allied to a stove described in the *Mechanic's Magazine*, vol. xxii. p. 81., and to Kirkwood's Stove, which, as being suitable to small green-houses, we intend to describe in our next Number. Various other improvements in close stoves and open fire places have also been examined

by us, but we do not think any of them worth especial recommendation. Wright's Kitchen-Range, which is now being exhibited in Arthur Street, London Bridge, has the fireplace enclosed in talc, so that no dust can possibly escape into the room, and yet the heat passing through the talc is found sufficient to roast meat. We mention inventions of this kind merely to show the reader that we endeavour to see and examine every thing in domestic economy and architecture, as well as in gardening, that pretends to be an improvement, though any thing that is likely to prove permanently so is very rarely to be met with.

On *Gardening and Rural Improvement in Foreign Countries* we have little to offer. We have noticed, under the head of North America (p. 38. and 528.), and also in p. 625., the extraordinary progress which gardening is making in that quarter of the world. In France, agriculture seems to be advancing more than horticulture; but M. Tripet-Leblanc, whose visit to England, in company with that much respected botanist and vegetable physiologist, M. Poiteau, we have noticed in p. 570., assures us that there now exists a great taste in Paris for florist's flowers; and by letters from MM. Soulange-Bodin and Vilmorin, we learn that the export of camellias from the ports of France to North America has considerably increased, since the navigation by steam was established between the Old and the New World. In Germany, and more especially at Berlin and in Vienna, botany and horticulture continue to be favourite pursuits. We have noticed (p. 625.) that Count Harrach, an accomplished nobleman, one of the greatest patrons of gardening in Germany, has lately been in England collecting rare plants, and procuring a design for a palace which he is about to build on one of his extensive estates in Bohemia. For the progress of gardening in the other countries of Europe and India, we must refer to our Table of Contents (p. vii.). Judging from the exhibition of the Sydney Floral and Horticultural Society (p. 473.), there is a considerable taste there for gardening; and that this will be the case in the new settlements of South Australia and New Zealand there can be no doubt, since the admirable principle on which these colonies are founded combines all the advantages of an old country with the great and almost unlimited resources of a new one. Of all the different parts of the world to which natives of Britain can emigrate, we know of none that presents advantages of climate, soil, and political arrangements equal with those asserted to be possessed by South Australia and New Zealand. The stream of new plants which is annually pouring into Europe from Australia does not appear to abate; for we have lately been kindly shown, by Captain Mangles, dried specimens of many new and

beautiful shrubs, and other plants, not yet either named or introduced, which he has received from his correspondents at the Swan River and other settlements. Many of these will be found described in Dr. Lindley's *Appendix to the Botanical Register*, mentioned below.

*Garden Literature.* — A variety of useful publications have appeared in the course of the year; and the *Sertum Orchidaceum* of Dr. Lindley, and the *Orchidaceæ of Mexico and Guatemala* of Mr. Bateman, continue to be the most splendid. Ranking with these works in artistical merit, but addressed to a much more extensive class of readers, is the *Ladies' Flower-Garden of Ornamental Annuals*, by Mrs. Loudon, already mentioned (p. 88. and 723.). This work is the commencement of a series, which is intended to include one volume of hardy annuals (now nearly completed); one of hardy biennials; one of hardy bulbs, tubers, corms, &c.; two or more of hardy herbaceous perennials; one of garden roses; one of hardy shrubs; one of hardy trees; one or more of green-house plants; and one or more of hot-house plants. The peculiar characteristic of each of these volumes will be, that several figures will be grouped together on the same plate; in consequence of which, the purchaser obtains figures of a much greater number of plants in proportion to the price of the book, than in any other work whatever. To this may be added, that by the kinds most nearly allied being placed together on the same plate, their distinctive differences are better recognised, and that the purchaser will find at one view all the plants of the same habit, which may be grown together. Each volume will be distinct, and quite complete in itself; so that the possessor of a small garden need not encumber himself with any green-house or hot-house plants; nor the florist who wishes to grow plants in pots, with any that are only fit for an open garden; while the possessor of the whole work will have a greater number of figures of ornamental plants, than he could obtain at the same cost, and in the same space, in any other work whatever. The object of this series of works is to popularise botany and ornamental gardening; and, from the very superior manner in which they are got up, and the very low price at which they are sold, they can hardly fail of the intended effect.

We may here mention a work which we intend to produce, nearly allied to the above. It will contain coloured plates, in groups, of all the plants in the world that have been described by botanists, arranged according to their natural orders, giving a group of plants belonging to each order, as far as this can be accomplished from documents accessible in London or Paris. There are others, we are aware, who could produce such a book better than ourselves; and, if Professor Lindley, Royle, or Hen-

slow, will undertake such a work, we will with pleasure relinquish our intention. Should they not do so, we shall make a commencement as soon as circumstances will permit. One work which has been commenced during the year, we must very strongly recommend to our botanical readers. It is an *Appendix to Edwards's Botanical Register*, by Dr. Lindley. It will consist of a complete alphabetical and systematical index of names, synonymes, and matter adjusted to the present state of systematic botany; and, as a book of reference, will be invaluable to the botanical cultivator, no less than to the man of science. Our new edition of Repton's *Works on Landscape-Gardening and Garden-Architecture*, already referred to in this summary, is the only work on landscape-gardening which has appeared during this or the last year; and it will, we are sure, prove a valuable addition to the library of every reading gardener. As an elementary book, Dr. Lindley's *Ladies' Botany*, abridged by himself, may be recommended in the strongest terms to all classes of persons; as may Westwood's *Entomologist's Text Book*, and Ingpen's *Instructions for Collecting and Rearing British Insects*.

*Obituary.*—Several very excellent gardeners and practical botanists have died in the course of the year. The loss of Mr. Hunneman (p. 208.) will be felt by botanists in every part of Europe. As one of the most magnificent patrons of gardening, and a truly excellent man, we have to lament the loss of the Duke of Bedford, whose name will be handed down to posterity, in a botanical point of view, as connected with some useful and ornamental works on agricultural grasses, and on heaths, willows, and coniferous plants.

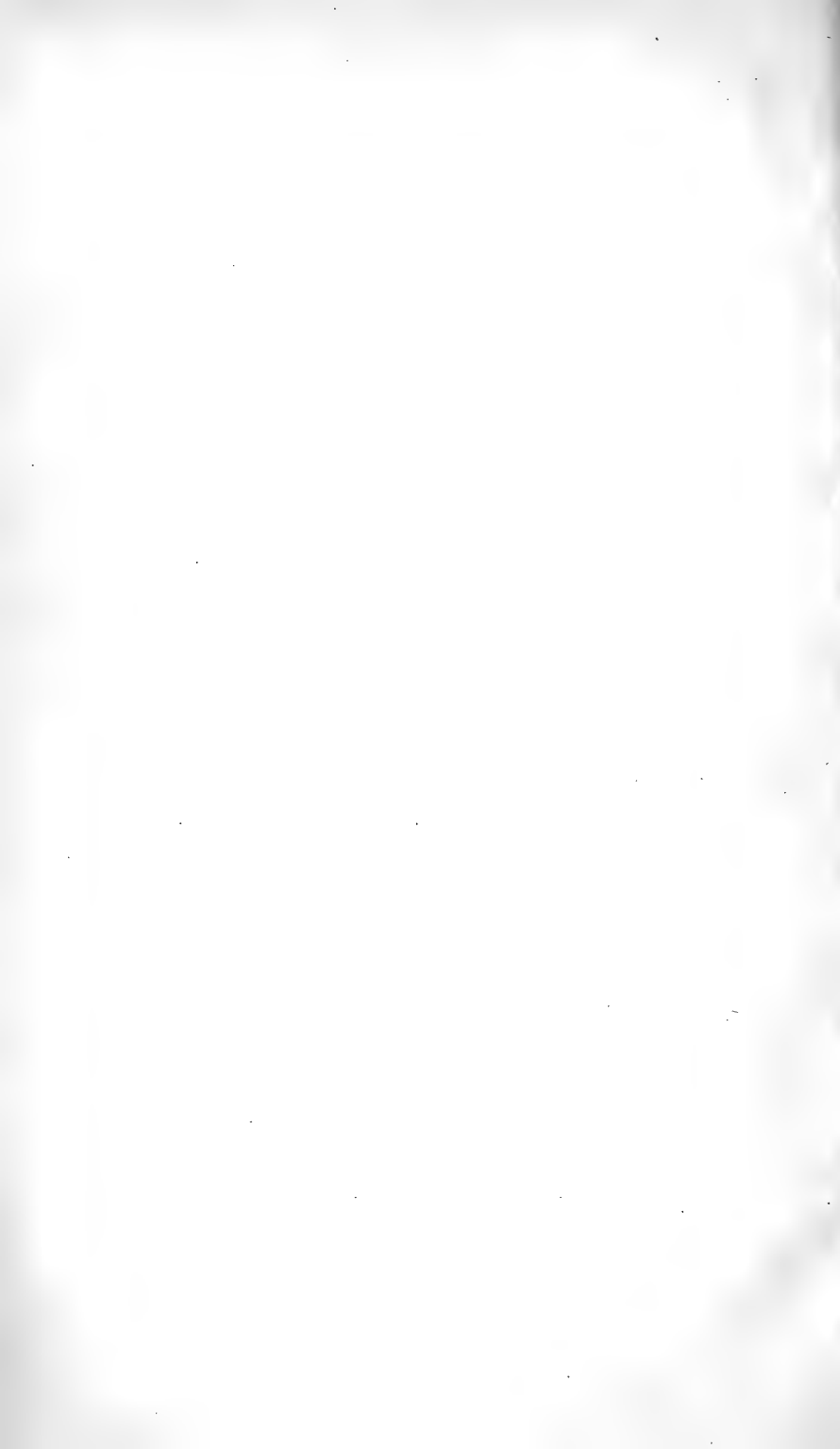
END OF THE FIFTEENTH VOLUME.



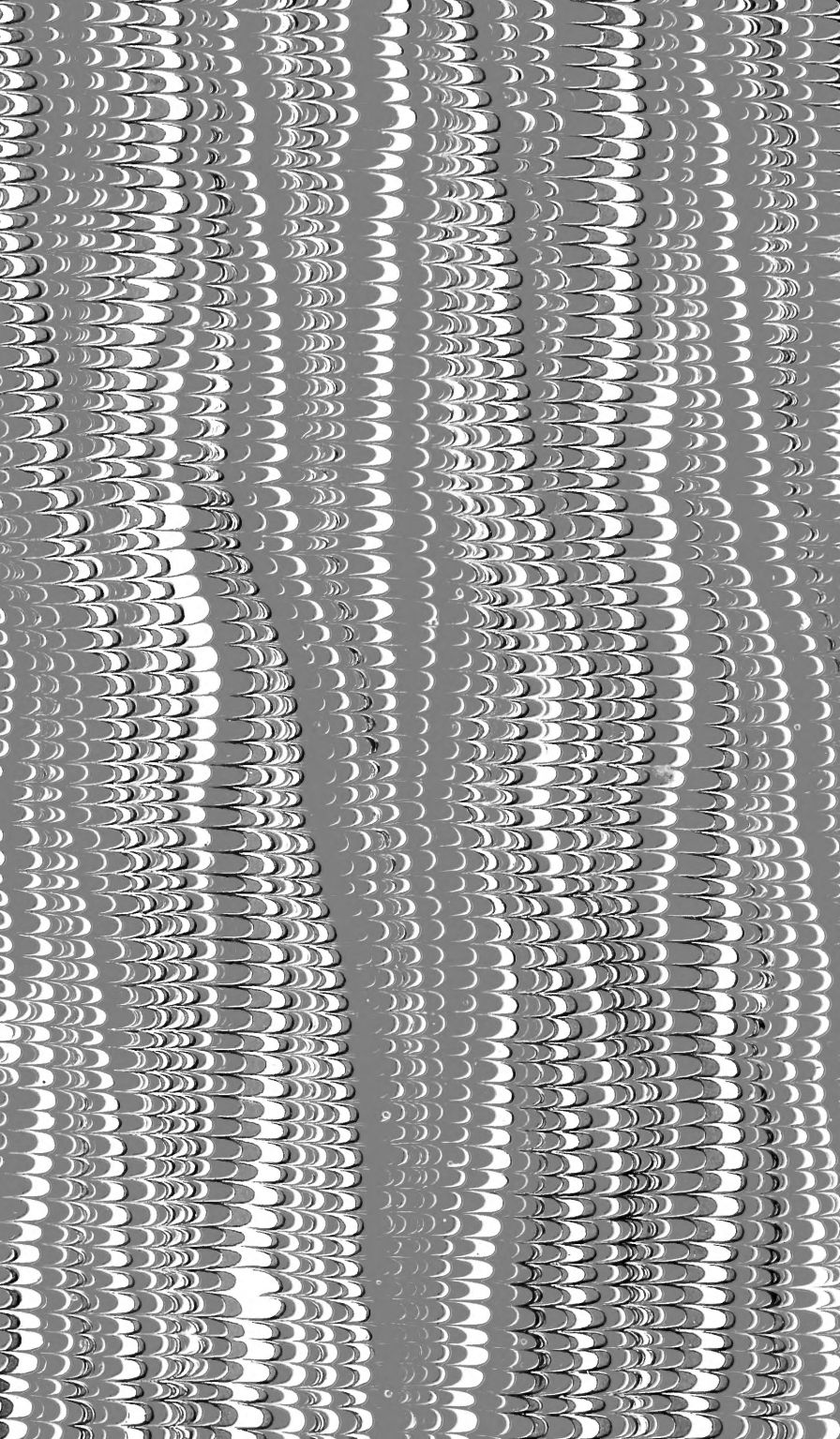


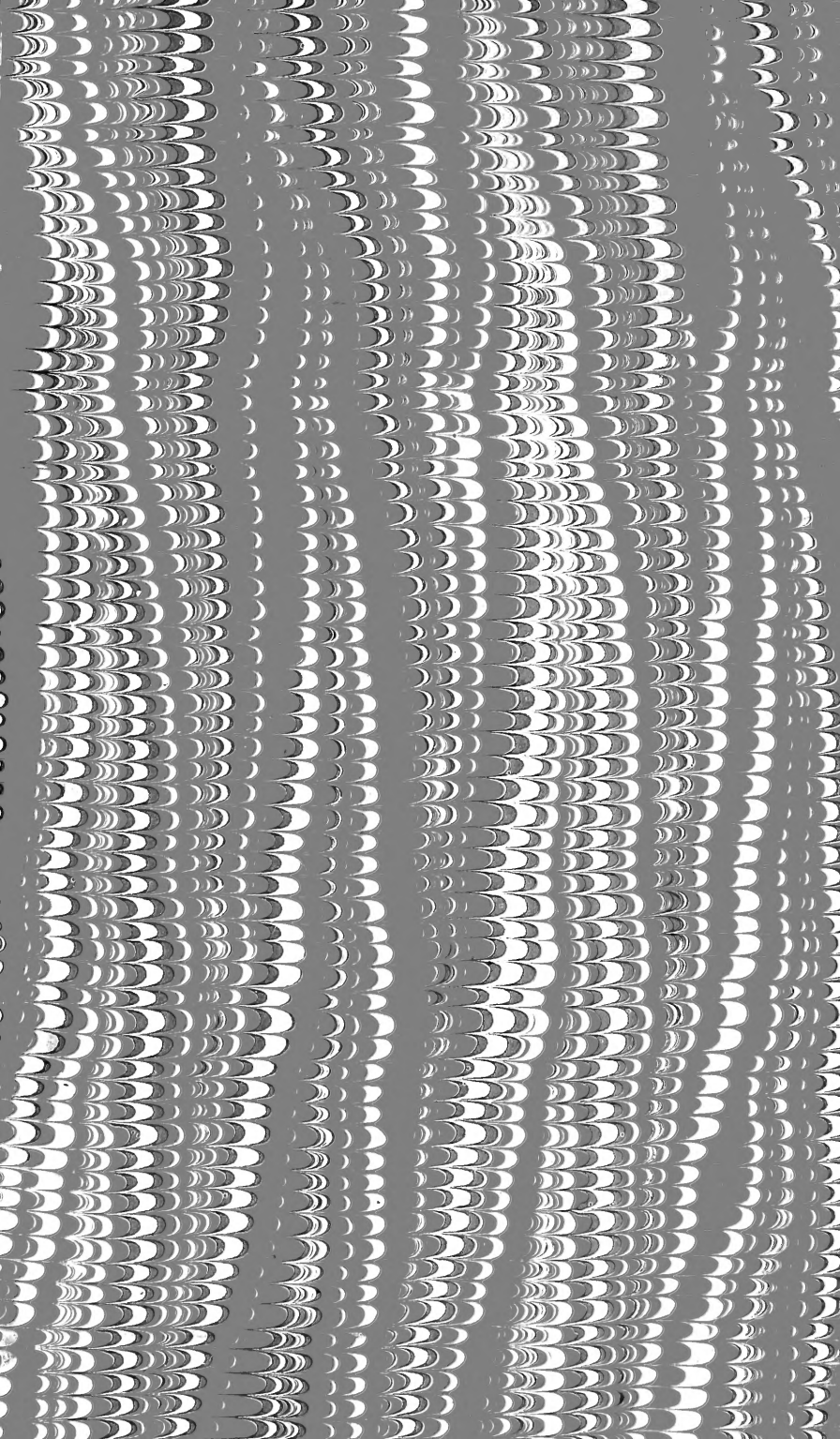












SMITHSONIAN INSTITUTION LIBRARIES



3 9088 01527 8492